

AQUA LOGIC

Automation and Chlorination



(actuators, cell & remote display not included - order separately)

Installation Manual

for models

AQL-PS-4

AQL-PS-8-V

AQL-PS-8

AQL-PS-16-V

AQL-PS-16

GOLDLINE
CONTROLS
A HAYWARD COMPANY

www.goldlinecontrols.com
888-921-7665

IMPORTANT SAFETY INSTRUCTIONS

When using this electrical equipment, basic safety precautions should always be followed, including the following:



- **READ AND FOLLOW ALL INSTRUCTIONS**
-  **WARNING: Disconnect all AC power during installation.**
-  **WARNING: Water in excess of 100 degrees Fahrenheit may be hazardous to your health.**
-  **WARNING: To reduce the risk of injury, do not permit children to use this product unless they are closely supervised at all times.**
- A green colored terminal marked “Earth Ground” is located inside the wiring compartment. To reduce the risk of electric shock, this terminal must be connected to the grounding means provided in the electric supply service panel with a continuous copper wire equivalent in size to the circuit conductors supplying the equipment.
- One bonding lug for US models (two for Canadian models) is provided on the external surface. To reduce the risk of electric shock, connect the local common bonding grid in the area of the swimming pool, spa, or hot tub to these terminals with an insulated or bare copper conductor not smaller than 8 AWG US / 6 AWG Canada.
- All field installed metal components such as rails, ladders, drains, or other similar hardware within 3 meters of the pool, spa or hot tub shall be bonded to the equipment grounding bus with copper conductors not smaller than 8 AWG US / 6 AWG Canada.
- **SAVE THESE INSTRUCTIONS**

Table of Contents

| | | |
|---------------------------------------|---|----|
| Introduction | Before You Begin..... | 1 |
| | Installation Steps..... | 2 |
| 1. Preparing Pool/Spa Water | General Water Chemistry..... | 3 |
| | Salt..... | 4 |
| 2. Mounting Equipment | Aqua Logic Control Center..... | 6 |
| | PS-16 Expansion Unit..... | 6 |
| | Temperature Sensors..... | 6 |
| | Optional AQL-CL Chlorination Kit..... | 6 |
| | Optional Wired Remote Display/Keypad..... | 7 |
| | Optional Wireless Remote Display/Keypad..... | 7 |
| | Optional Base Station..... | 8 |
| | Optional Valve Actuators..... | 8 |
| 3. Plumbing | “Standard” Pool/Spa Configuration..... | 9 |
| | “Dual Equipment” Pool/Spa - Separate Heaters..... | 10 |
| | “Dual Equipment” Pool/Spa - Shared Heaters..... | 11 |
| | Turbo Cell..... | 12 |
| | Flow Switch..... | 12 |
| 4. Electrical Wiring | Main Service..... | 13 |
| | Grounding and Bonding..... | 13 |
| | Circuit Breaker Installation and Wiring..... | 13 |
| | General Purpose Outlet..... | 14 |
| | Aqua Logic Control Power..... | 14 |
| | High Voltage Pool Equipment..... | 14 |
| | Low Voltage Wiring..... | 15 |
| 5. Configuration | Group Function..... | 22 |
| | Configuration Menus..... | 23 |
| 6. System Startup and Checkout | Before Startup..... | 37 |
| | Heater Checkout..... | 38 |
| | Service Mode..... | 38 |
| 7. Warranty | Aqua Logic Limited Warranty..... | 40 |

Introduction

Before You Begin

What's Included

Before attempting to install the Aqua Logic system, check that the following components have been included in the package:

Aqua Logic Electronics Unit

(3) Temperature sensors with 15 ft. (5m) cable, hose clamp

Aqua Logic Expansion Unit (PS-16 only)

What's NOT Included

Some of the additional items that you may need to complete an installation include:

Circuit breakers

None are included with control—see page 12 and inside of door for suitable breakers

Wire

4-conductor cable (electronics unit to remote display/keypad)

Wire/conduit for 100A service from main panel to Aqua Logic

Wire/conduit for filter pump and other high voltage loads

Wire for bonding

Miscellaneous

Utility electrical outlet and weatherproof cover (for mounting on side of Aqua Logic)

Mounting hardware (screws, etc.) for mounting Aqua Logic and remote display/keypad

Valves (use standard Hayward, Pentair/Compool, or Jandy valves)

Additional valve actuators

Accessory Products - Order Separately

| | |
|-------------------------|---|
| AQL-CL | Chlorination kit |
| AQL2-Wx-PS-4 | Wired Remote Display (see note 1) |
| AQL2-Wx-PS-8 | Wired Remote Display (see note 2) |
| AQL2-Wx-PS-16 | Wired Remote Display (see note 3) |
| AQL2-POD | Handheld wireless remote control |
| AQL2-Wx-RF-PS-4 | Wireless Wallmount Remote Control(see notes 1, 4, 5) |
| AQL2-Wx-RF-PS-8 | Wireless Wallmount Remote Control(see notes 2, 4, 5) |
| AQL2-Wx-RF-PS-16 | Wireless Wallmount Remote Control(see notes 3, 4, 5) |
| AQL2-Tx-RF-PS-4(x=W/B) | Wireless Table Top Remote Control, specify color - white or black (see notes 1,4,5) |
| AQL2-Tx-RF-PS-8(x=W/B) | Wireless Table Top Remote Control, specify color - white or black (see notes 2,4,5) |
| AQL2-Tx-RF-PS-16(x=W/B) | Wireless Table Top Remote Control, specify color - white or black (see notes 3,4,5) |
| AQL-SS-6B-x(x=W/G/B) | Wired Spa Side 6 Function Remote Control, 150ft cable, spec. color (white, gray or black) |
| AQL-SS-D-x(x=W/G/B) | Wired Spa Side 8 Function Remote Control, 150ft cable, spec. color (white, gray or black) |
| AQL2-SS-RF | Wireless Spa Side Remote Control (see note 4) |
| AQL2-BASE-RF | Base Station |
| AQL-DIM | Light Dimmer Relay |
| GVA-24 | Valve Actuator |
| V&A-xx | Valve & Actuator (xx=1P (1.5" pos. seal), -2P (2" pos. seal)) |

- Notes:
1. for use with PS-4 model only
 2. for use with PS-8 model only
 3. for use with PS-16 model only
 4. requires base station AQL2-BASE-RF
 5. 9V wall plug-in power supply included

NOTE: Before installing this product as part of a saline water purification system in a pool or spa using natural stone for coping or for immediately adjacent patios/decking, a qualified stone installation specialist should be consulted regarding the appropriate type, installation, sealant (if any) and maintenance of stone used around a saline pool with electronic chlorine generator in your particular location and circumstances.

Installation Steps

Details on each installation step are presented on the following pages:

1. Prepare the pool water (page 3)
 - General Water Chemistry
 - Salt
2. Mounting the equipment (page 6)
 - Aqua Logic main unit
 - Remote display/keypad (optional)
 - Temperature sensors
 - Valve actuators (if applicable)
3. Plumbing (page 9)
 - General Pool Equipment
 - Turbo Cell
 - Flow Switch
4. Electrical Wiring (page 13)
 - Main service
 - Grounding and bonding
 - Circuit breakers
 - Aqua Logic control power
 - High Voltage pool equipment
 - Low voltage wiring (temperature sensors, flow switch, etc.)
5. Aqua Logic control configuration (program desired control operation) (page 22)
6. System Startup and checkout (page 36)

1. Preparing Pool/Spa Water

General Water Chemistry

Salt is required only if you are using the chlorinator features on the Aqua Logic Control. If you are NOT using the chlorinator, it is recommended that you follow all of the other chemistry recommendations besides salt. Refer to the description of the Aqua Logic configuration menu for information on enabling/disabling the chlorinator (see page 23).

Water Chemistry

The table below summarizes the levels that are recommended by the Association of Pool and Spa Professionals (APSP). The only special requirements for the Aqua Logic are the salt level and stabilizer.

| CHEMICAL | IDEAL LEVELS |
|----------------------------|----------------------------|
| Salt | 2700 to 3400 ppm |
| Free Chlorine | 1.0 to 3.0 ppm |
| pH | 7.2 to 7.6 |
| Cyanuric Acid (Stabilizer) | 60 to 80 ppm (80 ppm best) |
| Total Alkalinity | 80 to 120 ppm |
| Calcium Hardness | 200 to 400 ppm |
| Metals | 0 ppm |
| Saturation Index | -0.2 to +0.2 (0.0 best) |

Saturation index

The saturation index (Si) relates to the calcium and alkalinity in the water and is an indicator of the pool water "balance". Your water is properly balanced if the Si is 0 ± 0.2 . If the Si is below -0.2, the water is corrosive and plaster pool walls will be dissolved into the water. If the Si is above +0.2, scaling and staining will occur. Use the chart below to determine the saturation index.

$$Si = pH + Ti + Ci + Ai - 12.1$$

| °C | °F | Ti | Calcium Hardness | Ci | Total Alkalinity | Ai |
|----|-----|----|------------------|-----|------------------|-----|
| 12 | 53 | .3 | 75 | 1.5 | 75 | 1.9 |
| 16 | 60 | .4 | 100 | 1.6 | 100 | 2.0 |
| | | | 125 | 1.7 | 125 | 2.1 |
| 19 | 66 | .5 | 150 | 1.8 | 150 | 2.2 |
| | | | 200 | 1.9 | 200 | 2.3 |
| 24 | 76 | .6 | 250 | 2.0 | 250 | 2.4 |
| | | | 300 | 2.1 | 300 | 2.5 |
| 29 | 84 | .7 | 400 | 2.2 | 400 | 2.6 |
| | | | 600 | 2.4 | 600 | 2.8 |
| 34 | 94 | .8 | 800 | 2.5 | 800 | 2.9 |
| 39 | 103 | .9 | | | | |

How to use: Measure pool pH, temperature, calcium hardness, and total alkalinity. Use the chart above to determine Ti, Ci, and Ai from your measurements. Insert values of pH, Ti, Ci and Ai into the above equation. If Si equals .2 or more, scaling and staining may occur. If Si equals -.2 or less corrosion or irritation may occur.

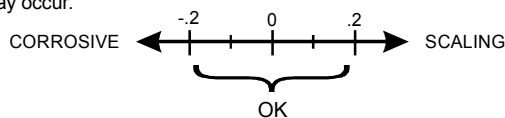

The pool's chemistry must be balanced BEFORE activating the Aqua Logic's optional chlorinator function. NOTE: If the pool does not have new water, add metal remover and non-copper based algaecide to the pool, per manufacturer's instructions. This ensures a quick, troublefree transfer to the Aqua Logic system.

Salt (When using optional chlorinator function - requires AQL-CL chlorination kit)

Salt Level

Use the chart below to determine how much salt in pounds or (Kgs) should be added to reach the recommended levels. Use the equations on the following page (measurements are in feet/gallons and meters/liters) if pool size is unknown.

The operating salt level is between 2700-3400 PPM (parts per million) with 3200 PPM being optimal. Before adding any salt, test the salt level. This is especially important for retrofit installation to older pools where all of the chlorine added to the pool over time is ending up as salt. If the level is low, determine the number of gallons in the pool and add salt according to the chart below. A low salt level will reduce the efficiency of the sanitization and result in low chlorine production. A high salt level can cause the Aqua Logic to stop chlorinating. The salt in your pool/spa is constantly recycled and the loss of salt throughout the swimming season should be minimal. This loss is due primarily to the addition of water because of splashing, backwashing, or draining (because of rain). Salt is not lost due to evaporation.

POUNDS and (Kg) OF SALT NEEDED FOR 3200 PPM

| Current salt level ppm | Gallons and (Liters) of Pool/Spa water | | | | | | | | | | | | | | | | |
|------------------------|--|--------------------|--------------------|--------------------|--------------------|--------------------|--------------------|--------------------|--------------------|--------------------|---------------------|---------------------|---------------------|---------------------|---------------------|---------------------|---------------------|
| | 8,000 (30,000) | 10,000 (37,500) | 12,000 (45,000) | 14,000 (52,500) | 16,000 (60,000) | 18,000 (67,500) | 20,000 (75,000) | 22,000 (82,500) | 24,000 (90,000) | 26,000 (97,500) | 28,000 (105,000) | 30,000 (112,500) | 32,000 (120,000) | 34,000 (127,500) | 36,000 (135,000) | 38,000 (142,500) | 40,000 (150,000) |
| 0 | 213 (97) | 267 (121) | 320 (145) | 373 (170) | 427 (194) | 480 (218) | 533 (242) | 587 (267) | 640 (291) | 693 (315) | 747 (339) | 800 (364) | 854 (388) | 907 (412) | 960 (436) | 1013 (460) | 1067 (484) |
| 200 | 200 (91) | 250 (114) | 300 (136) | 350 (159) | 400 (182) | 450 (205) | 500 (227) | 550 (250) | 600 (273) | 650 (295) | 700 (318) | 750 (341) | 800 (363) | 850 (385) | 900 (408) | 950 (430) | 1000 (453) |
| 400 | 187 (85) | 233 (106) | 280 (127) | 327 (148) | 373 (170) | 420 (191) | 467 (212) | 513 (233) | 560 (255) | 607 (276) | 653 (297) | 700 (318) | 747 (339) | 793 (360) | 840 (382) | 887 (403) | 933 (424) |
| 600 | 173 (79) | 217 (98) | 260 (118) | 303 (138) | 347 (158) | 390 (177) | 433 (197) | 477 (217) | 520 (236) | 563 (256) | 607 (276) | 650 (297) | 693 (317) | 737 (337) | 780 (358) | 823 (378) | 867 (398) |
| 800 | 160 (73) | 200 (91) | 240 (109) | 280 (127) | 320 (145) | 360 (164) | 400 (182) | 440 (200) | 480 (218) | 520 (236) | 560 (255) | 600 (273) | 640 (291) | 680 (310) | 720 (328) | 760 (346) | 800 (364) |
| 1000 | 147 (67) | 183 (83) | 220 (100) | 257 (117) | 293 (133) | 330 (150) | 367 (167) | 403 (183) | 440 (200) | 477 (217) | 513 (233) | 550 (250) | 587 (267) | 623 (283) | 660 (300) | 697 (317) | 733 (333) |
| 1200 | 133 (61) | 167 (76) | 200 (91) | 233 (106) | 267 (121) | 300 (136) | 333 (152) | 367 (167) | 400 (182) | 433 (197) | 467 (212) | 500 (227) | 533 (243) | 567 (258) | 600 (274) | 633 (289) | 667 (304) |
| 1400 | 120 (55) | 150 (68) | 180 (82) | 210 (95) | 240 (109) | 270 (123) | 300 (136) | 330 (150) | 360 (164) | 390 (177) | 420 (191) | 450 (205) | 480 (218) | 510 (232) | 540 (246) | 570 (259) | 600 (263) |
| 1600 | 107 (48) | 133 (61) | 160 (73) | 187 (85) | 213 (97) | 240 (109) | 267 (121) | 293 (133) | 320 (145) | 347 (158) | 373 (170) | 400 (182) | 427 (195) | 453 (207) | 480 (219) | 507 (231) | 533 (243) |
| 1800 | 93 (42) | 117 (53) | 140 (64) | 163 (74) | 187 (85) | 210 (95) | 233 (106) | 257 (117) | 280 (127) | 303 (138) | 327 (148) | 350 (159) | 373 (169) | 397 (180) | 420 (190) | 443 (201) | 467 (211) |
| 2000 | 80 (36) | 100 (45) | 120 (55) | 140 (64) | 160 (73) | 180 (82) | 200 (91) | 220 (100) | 240 (109) | 260 (118) | 280 (127) | 300 (136) | 320 (145) | 340 (154) | 360 (163) | 380 (172) | 400 (181) |
| 2200 | 67 (30) | 83 (38) | 100 (45) | 117 (53) | 133 (61) | 150 (68) | 167 (76) | 183 (83) | 200 (91) | 217 (98) | 233 (106) | 250 (114) | 267 (121) | 283 (129) | 300 (137) | 317 (144) | 333 (152) |
| 2400 | 53 (24) | 67 (30) | 80 (36) | 93 (42) | 107 (48) | 120 (55) | 133 (61) | 147 (67) | 160 (73) | 173 (79) | 187 (85) | 200 (91) | 213 (98) | 227 (104) | 240 (110) | 253 (117) | 267 (123) |
| 2600 | 40 (18) | 50 (23) | 60 (27) | 70 (32) | 80 (36) | 90 (41) | 100 (45) | 110 (50) | 120 (55) | 130 (59) | 140 (64) | 150 (68) | 160 (73) | 170 (77) | 180 (81) | 190 (86) | 200 (90) |
| 2800 | 27 (12) | 33 (15) | 40 (18) | 47 (21) | 53 (24) | 60 (27) | 67 (30) | 73 (33) | 80 (36) | 87 (39) | 93 (42) | 100 (45) | 107 (48) | 113 (51) | 120 (54) | 127 (57) | 133 (60) |
| 3000 | 13 (6) | 17 (8) | 20 (9) | 23 (11) | 27 (12) | 30 (14) | 33 (15) | 37 (17) | 40 (18) | 43 (20) | 47 (21) | 50 (23) | 53 (24) | 57 (26) | 60 (27) | 63 (29) | 67 (30) |
| 3200 | Ideal | Ideal | Ideal | Ideal | Ideal | Ideal | Ideal | Ideal | Ideal | Ideal | Ideal | Ideal | Ideal | Ideal | Ideal | Ideal | Ideal |
| 3400 | OK | OK | OK | OK | OK | OK | OK | OK | OK | OK | OK | OK | OK | OK | OK | OK | OK |
| 3600+ | Dilute | Dilute | Dilute | Dilute | Dilute | Dilute | Dilute | Dilute | Dilute | Dilute | Dilute | Dilute | Dilute | Dilute | Dilute | Dilute | Dilute |

Pool Sizing Formula

| | Gallons (pool size in feet) | Liters (pool size in meters) |
|--------------------|--|--|
| Rectangular | Length x Width x Average Depth x 7.5 | Length x Width x Average Depth x 1000 |
| Round | Diameter x Diameter x Average Depth x 5.9 | Diameter x Diameter x Average Depth x 785 |
| Oval | Length x Width x Average Depth x 6.7 | Length x Width x Average Depth x 893 |

Type of Salt to Use

It is important to use only sodium chloride (NaCl) salt that is greater than 99.0% pure. This can be found at most pool stores in 40-80 lb. bags labeled “for use in swimming pools”. Alternatively, use common food quality or water softener salt that is at least 99.0% pure. It is also acceptable to use water conditioning salt pellets, however, it will take longer for them to dissolve. Do not use rock salt, or salt with more than 1% of yellow prussiate of soda, salt with anti-caking additives, or iodized salt.

How to Add Salt

For new plaster pools, wait 10-14 days before adding salt to allow the plaster to cure. Turn the circulating pump on and add salt directly into the pool. Brush the salt around to speed up the dissolving process—do not allow salt to pile up on the bottom of the pool. Run the filter pump for 24 hours with the suction coming from the main drain (use pool vacuum if there is no main drain) to allow the salt to evenly disperse throughout the pool. The salt display may take 24 hours to respond to the change in salt concentration.

Always check stabilizer (cyanuric acid), when checking salt. These levels will most likely decline together. Use the chart below to determine how much stabilizer must be added to raise the level to 80 ppm.

POUNDS and (Kg) OF STABILIZER (CYANURIC ACID) NEEDED FOR 80 PPM

| Current Stabilizer Level (ppm) | Gallons and (Liters) of Pool/Spa water | | | | | | | | | | | | | | | | |
|--------------------------------|--|-------------------|-------------------|-------------------|-------------------|-------------------|-------------------|-------------------|-------------------|-------------------|--------------------|--------------------|--------------------|--------------------|--------------------|--------------------|--------------------|
| | 8,000 (30000) | 10,000 (37500) | 12,000 (45000) | 14,000 (52500) | 16,000 (60000) | 18,000 (67500) | 20,000 (75000) | 22,000 (82500) | 24,000 (90000) | 26,000 (97500) | 28,000 (105000) | 30,000 (112500) | 32,000 (120000) | 34,000 (127500) | 36,000 (135000) | 38,000 (142500) | 40,000 (150000) |
| 0 ppm | 5.3 (3.6) | 6.7 (4.3) | 8.0 (3.6) | 9.4 (4.3) | 10.7 (4.9) | 12.0 (5.4) | 13.4 (6.1) | 14.7 (6.7) | 16.0 (7.3) | 17.3 (7.9) | 18.7 (8.5) | 20.0 (9.1) | 21.3 (9.7) | 22.7 (10.3) | 24.0 (10.9) | 25.3 (11.5) | 26.7 (12.0) |
| 10 ppm | 4.7 (3.2) | 5.8 (3.7) | 7.0 (3.2) | 8.2 (3.7) | 9.4 (4.3) | 10.5 (4.8) | 11.7 (5.3) | 12.9 (5.9) | 14.0 (6.4) | 15.2 (6.9) | 16.4 (7.4) | 17.2 (8.0) | 18.7 (8.5) | 19.8 (9.0) | 21.0 (9.5) | 22.2 (10.0) | 23.3 (10.5) |
| 20 ppm | 4.0 (2.7) | 5.0 (3.2) | 6.0 (2.7) | 7.0 (3.2) | 8.0 (3.6) | 9.0 (2.2) | 10.0 (4.5) | 11.0 (5.0) | 12.0 (5.4) | 13.0 (5.9) | 14.0 (6.4) | 15.0 (6.8) | 16.0 (7.2) | 17.0 (7.7) | 18.0 (8.1) | 19.0 (8.6) | 20.0 (9.0) |
| 30 ppm | 3.3 (2.3) | 4.2 (2.7) | 5.0 (2.3) | 5.9 (2.7) | 6.7 (3.0) | 7.5 (3.4) | 8.4 (3.8) | 9.2 (4.2) | 10.0 (4.5) | 10.8 (4.9) | 11.7 (5.2) | 12.5 (5.6) | 13.3 (6.0) | 14.2 (6.3) | 15.0 (6.7) | 15.8 (7.1) | 16.7 (7.5) |
| 40 ppm | 2.7 (1.8) | 3.3 (2.1) | 4.0 (1.8) | 4.7 (2.1) | 5.4 (2.4) | 6.0 (2.7) | 6.7 (3.0) | 7.4 (3.3) | 8.0 (3.6) | 8.7 (3.9) | 9.3 (4.2) | 10.0 (4.5) | 10.7 (4.8) | 11.3 (5.1) | 12.0 (5.4) | 12.7 (5.7) | 13.3 (6.0) |
| 50 ppm | 2.0 (1.4) | 2.5 (1.6) | 3.0 (1.4) | 3.5 (1.6) | 4.0 (1.8) | 4.5 (2.0) | 5.0 (2.3) | 5.5 (2.5) | 6.0 (2.7) | 6.5 (2.9) | 7.0 (3.2) | 7.5 (3.4) | 8.0 (3.6) | 8.5 (3.9) | 9.0 (4.1) | 9.5 (4.3) | 10.0 (4.5) |
| 60 ppm | 1.3 (.91) | 1.7 (1.1) | 2.0 (.91) | 2.3 (1.1) | 2.7 (1.2) | 3.0 (1.4) | 3.3 (1.5) | 3.7 (1.7) | 4.0 (1.8) | 4.3 (2.0) | 4.7 (2.1) | 5.0 (2.3) | 5.3 (2.4) | 5.7 (2.6) | 6.0 (2.7) | 6.3 (2.8) | 6.7 (3.0) |
| 70 ppm | 0.7 (.45) | 0.8 (.54) | 1.0 (.45) | 1.2 (.54) | 1.4 (.64) | 1.5 (.68) | 1.7 (.77) | 1.8 (.82) | 2.0 (.91) | 2.2 (1.0) | 2.3 (1.1) | 2.5 (1.2) | 2.7 (1.2) | 2.8 (1.3) | 3.0 (1.3) | 3.2 (1.4) | 3.3 (1.5) |
| 80 ppm | 0.0 | 0.0 | 0.0 | 0.0 | 0.0 | 0.0 | 0.0 | 0.0 | 0.0 | 0.0 | 0.0 | 0.0 | 0.0 | 0.0 | 0.0 | 0.0 | 0.0 |

2. Mounting the Equipment

Aqua Logic Control Center

The Aqua Logic is contained in a raintight enclosure that is suitable for outdoor mounting. The control must be mounted a minimum of 5 ft. (2 meters) horizontal distance from the pool/spa (or more, if local codes require). The Control Center is designed to mount vertically on a flat surface with the knockouts facing downward. Because the enclosure also acts as a heat sink (disperses heat from inside the box), it is important not to block the four sides of the control. Do not mount the Aqua Logic inside a panel or tightly enclosed area.

When selecting a location, note that the standard cables supplied with the Turbo Cell, flow switch, temperature sensors, and valve actuators (if applicable) are all 15 ft. (5m) long. Call the Goldline Service Dept. (888-921-7665) for information regarding longer cables.

PS-16 Expansion Unit

For the PS-16, the relays for Aux1-6 are contained in the Aqua Logic Control Center. The relays for Aux7-14 are contained in the PS-16 Expansion Unit. Valve outputs 7-10, in the PS-16 Expansion Unit follow the outputs of Aux7-10, respectively.

Temperature Sensors

Three sensors are included with the Aqua Logic. A water sensor and an air sensor must be installed at all times for proper operation. A solar sensor is required if the solar function or “dual equipment” is enabled.

Water Sensor

This sensor is used to measure the pool/spa temperature and is installed in the filtration plumbing after the filter but before either the solar or conventionally fueled heaters—refer to the plumbing overview diagram.

1. Drill a 3/8” (10mm) diameter hole in the PVC piping and remove all chips and burrs.
2. Insert sensor until O-ring collar sits flush on the hole.
3. Position hose clamp over the sensor and gently tighten until O-ring makes an adequate seal. Do not overtighten.
4. For maximum temperature accuracy, cover the sensor and 3” (6cm) of pipe on either side with insulation and white paint.

Air Sensor

Mount the air sensor outdoors.  **IMPORTANT: Mount the air sensor out of direct sunlight.**

Solar Sensor (Spa Sensor if using “Dual Equipment”)

For solar applications, mount the sensor near the solar collector array so that it is exposed to the same sunlight as the collectors. For Dual Equipment applications, mount the sensor after the spa filter but before the heater (see page 10). Use additional cable (20 AWG) if necessary.

Optional AQL-CL Chlorination Kit

The AQL-PS-4/8/16 models require the use of the AQL-CL or AQL-CL-25FT chlorination kit when using the chlorinator function. This kit contains a Turbo Cell, cell unions and flow switch. Refer to pages 12 and 20 for plumbing and wiring instructions.

Optional Remote Controls

Goldline offers a variety of wired and wireless remote control options for the Aqua Logic. Each model gives you the ability to control your pool’s functions from a remote location, away from the Control Center.

Wired Remote Controls

Up to 3 wired remote controls can be installed. See “Electrical Wiring” (page 19) for instructions on running the cable from the Aqua Logic main unit to the remote control. Also refer to the remote’s installation instructions for more information.

AQL-WW-PS-x (x=4,8, or 16), AQL2-Wx-PS-x (x=4,8, or 16)

The AQL-WW-PS-x and AQL2-Wx-PS-x display/keypads must be mounted indoors or in a weather protected area (rain should never hit the unit). Note that the number of outputs on the remote (“4”, “8” or “16”) must match the outputs on the Aqua Logic main control unit. The display/keypad is designed to mount onto a standard electrical utility box (same box as a triple light switch, ideal for new construction) or can be mounted directly onto any wall surface. When selecting a location, note that the wire to the Aqua Logic main unit must be less than 500’ long.

AQL-SS-6B-x, AQL-SS-D-x (x=W, G or B for White, Gray or Black)

The AQL-SS-6B and AQL-SS-D are double insulated, waterproof devices which are intended for installation at the water’s edge. The remote controls come with an attached 150’ cable and are typically installed at the tile-line of the spa wall, or in the deck, within arm’s reach of a pool/spa occupant.

Wireless Remote Controls

A single Base Station must be installed on the Aqua Logic in order to use any of the Goldline wireless remote controls. With the Base Station installed, there is no limit on the number of wireless remotes that can be used. The maximum distance between the wireless remotes and the base station on the Aqua Logic main control unit is 400 feet (120m) line of sight or 200 feet (60m) through walls, etc. If in doubt about the distance, test operation before installing the remote.

Use AQL-BASE-RF for all AQL wireless remote controls. Use AQL2-BASE-RF for all AQL2 wireless remote controls.

All wireless models require the user to run the “Teach Wireless” routine in the Settings Menu. This information can be found in the Aqua Logic Operation Manual and the owner’s manual of each remote.

AQL-WW-RF-PS-x, AQL-Wx-RF-PS-x (x=4,8, or 16)

The AQL-WW-RF-PS-x is a wall mounted display/keypad and must be mounted indoors or in a weather protected area (rain should never hit the unit). Note that number of outputs on the remote (e.g. “4”, “8” or “16”) must match the outputs on the Aqua Logic Control Center. Also note that the remote must be within 6 feet of a standard 120V wall outlet for the plug-in power supply included with the unit.

AQL-Tx-RF-PS-x, AQL2-Tx-RF-PS-x (x=4,8, or 16)

The AQL-Tx-RF-PS-x and AQL2-Tx-RF-PS-x are portable battery operated remote controls designed to be used in a weather protected area (rain should never hit the unit). Both remotes come with a wall mounted power supply for recharging the built-in batteries.

AQL-SS-RF, AQL2-SS-RF, AQL2-POD

The AQL-SS-RF, AQL2-SS-RF and AQL2-POD are waterproof portable remote controls that are designed to be used in and around the pool/spa area. These units float and can be left in the pool/spa water for easy access.

Optional Base Station

The optional base station, Goldline part number AQL-BASE-RF or AQL2-BASE-RF, must be installed if any wireless remote control is used. Use the proper base station for the desired remote control - AQL-BASE-RF for AQL remote controls or AQL2-BASE-RF for AQL2 remote controls. To install the base station, remove the knockout on the upper left side of the Aqua Logic main control unit, insert the base station, and then tighten the nut from the inside. Also refer to the Base Station manual and the diagram on page 20.

Optional Valve Actuators

For optional actuators supplied with the Aqua Logic—note that the internal cams in the actuator may also have to be adjusted depending on the way the actuator is mounted on the valve and the desired valve action.

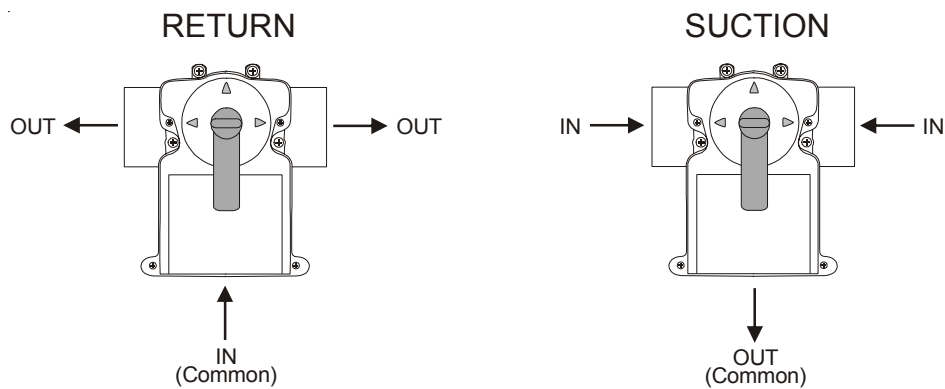

3. Plumbing

“Standard” Pool/Spa system configuration

These systems use a single filter pump and filter. Pool or spa operation is controlled by two 3-way valves (suction and return). Refer to the diagram below.

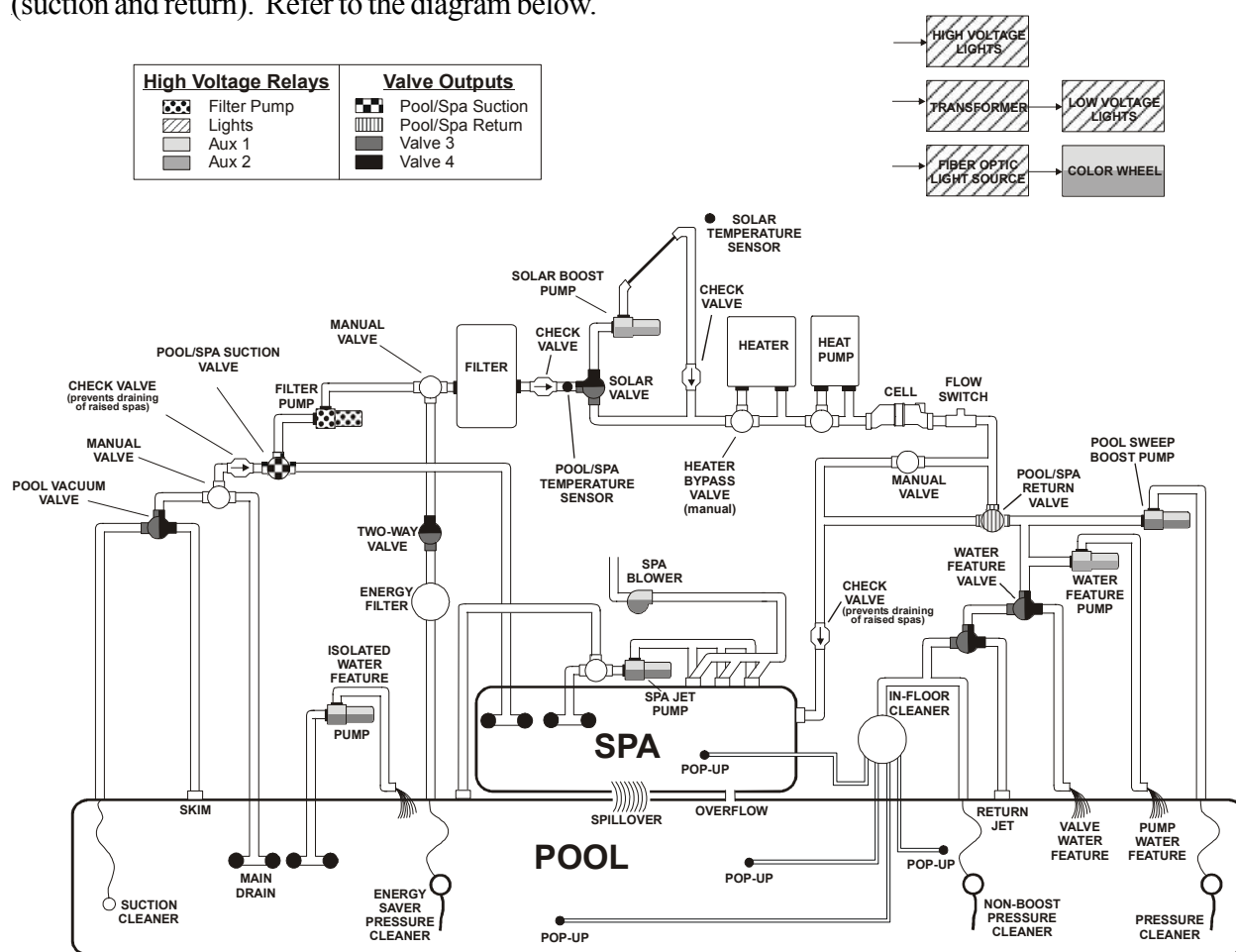

Some important notes regarding the Aqua Logic control of Standard Pool/Spa systems:

In Pool/Spa Config., select: Pool/Spa Setup
Pool and Spa-Std

1. The Aqua Logic can be programmed to accommodate spa spillover, if desired.
2. Up to two conventional heaters (gas or heat pump) plus solar can be used to heat both the pool and the spa.
3. If the chlorinator cell is plumbed prior to the pool/spa return valve, then both the pool and the spa can be chlorinated.
4. The water sensor should be installed prior to any heater or solar and will display either the pool or the spa temperature, depending on the current operation of the pool. The temperature will only be displayed when the filter pump is running.
5. If any water feature or pressure side cleaner boost pumps are used, be sure to enable the “interlock” feature (see “Configuration Menu” for details) to ensure that the pumps operate only when the filter pump is on and the system is in the “pool only” operating mode.
6. The plumbing diagram above is intended to be used as a general guideline and is not a complete plumbing schematic for the pool.
7. The air sensor must be installed if the freeze protection feature is enabled for the filter, valves or aux outputs.

“Dual Equipment - Separate Heaters” for Pool/Spa configuration

These systems have 2 complete sets of equipment (filter pump, filter, heater)—1 set for the pool and the other set for the spa. Refer to the diagram below:

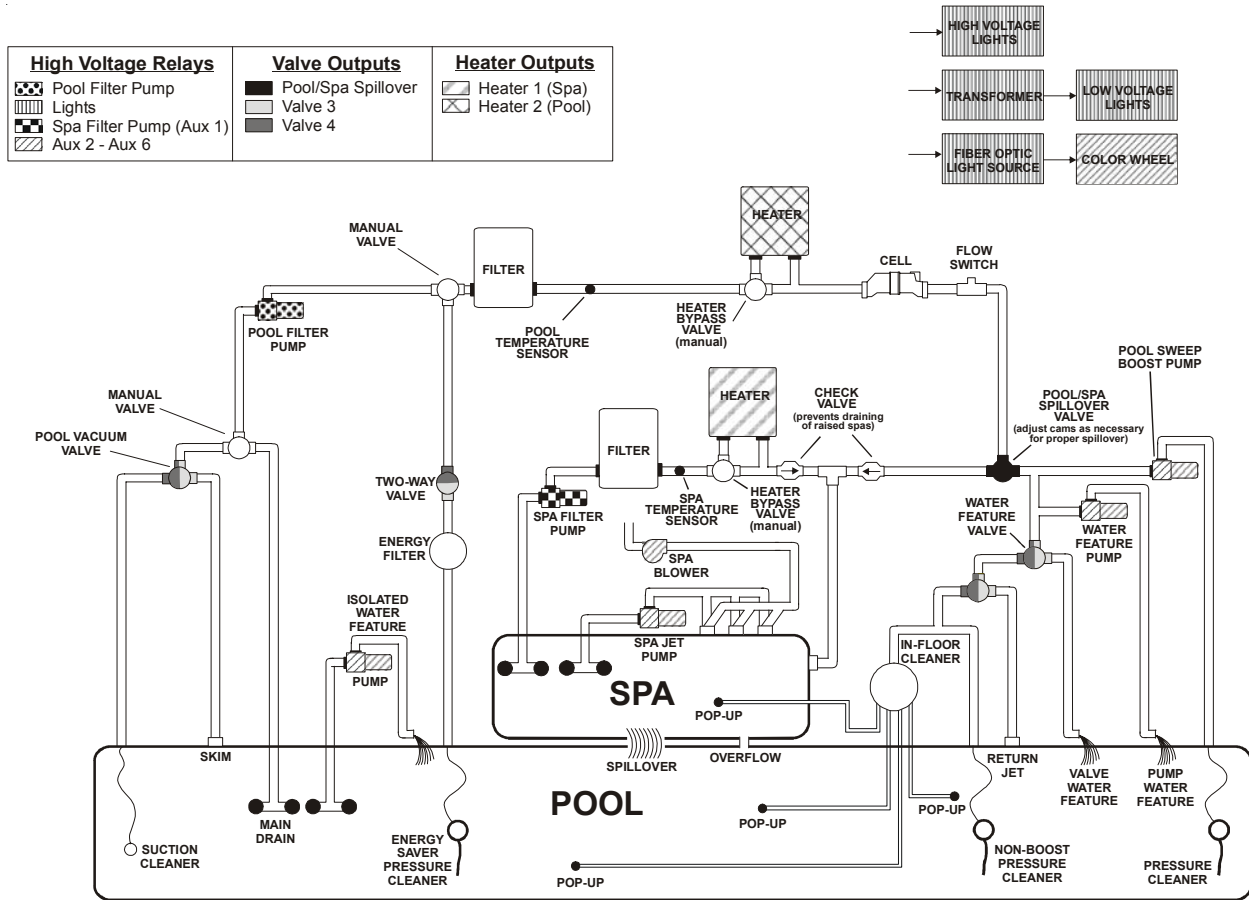

Some important notes regarding the Aqua Logic control of Dual Equipment Pool/Spa systems with separate heaters:

In the Pool/Spa Config., select:

| | |
|-------------------------------------|------------------------------------|
| Pool/Spa Setup Pool and Spa-Dual | Heaters Htr1 = Spa, Htr2 = Pool |
|-------------------------------------|------------------------------------|

1. When dual equipment is selected:
 - a. The “Filter” pump automatically is renamed “Pool Filter” and can not be changed. The pool filter can be a one or two speed pump.
 - b. The “Aux1” output is automatically renamed “Spa Filter”, its function is set to “Timeclock” and the Interlock feature is forced to “Disabled”. None of these can be changed. The spa filter can be a one or two speed pump.
 - c. The Heater1 output should be connected to the spa heater—the heater will only turn on when the spa filter pump is running.
 - d. The Heater2 output should be connected to the pool heater—the heater will only operate when the pool filter is running. If the system does not have a pool heater, disable Heater2 in the configuration menu and then the relay can be used to operate general purpose Valve4.
2. The water sensor should be installed on the pool loop prior to the heater and will display the pool temperature whenever the “Pool Filter” pump is running.

3. The solar sensor should be installed on the spa loop prior to the heater and will display the spa temperature whenever the “Spa Filter” pump is running.
4. Solar heater control is NOT available for dual equipment systems.
5. The Aqua Logic can be programmed to accommodate spillover if desired. Note that spillover operation will be automatically suspended whenever the spa filter pump is turned on.
6. The chlorinator cell must be installed in the pool plumbing. If spillover is enabled, then the Aqua Logic can chlorinate both the pool and spa (during spillover operation). Otherwise, the Aqua Logic will only chlorinate the pool and the spa sanitization will have to be handled manually.
7. If any water feature or pressure side cleaner boost pumps are used, be sure to enable the “interlock” feature (see “Configuration Menu” for details) to ensure that the pumps operate only when the “Pool Filter” pump is on and the system is in the “pool only” operating mode.
8. The plumbing diagram on page 10 is intended to be used as a general guideline and is not a complete plumbing schematic for the pool.
9. When using the wireless spa-side remote control (AQL-SS-RF), the “POOL” button will position the valves for Pool mode and the “SPA” button will position the valves for Spillover mode.

“Dual Equipment - Shared Heaters” for Pool/Spa configuration

These systems have 2 complete sets of equipment (filter pump, filter) and shared heaters. Refer to the diagram below:

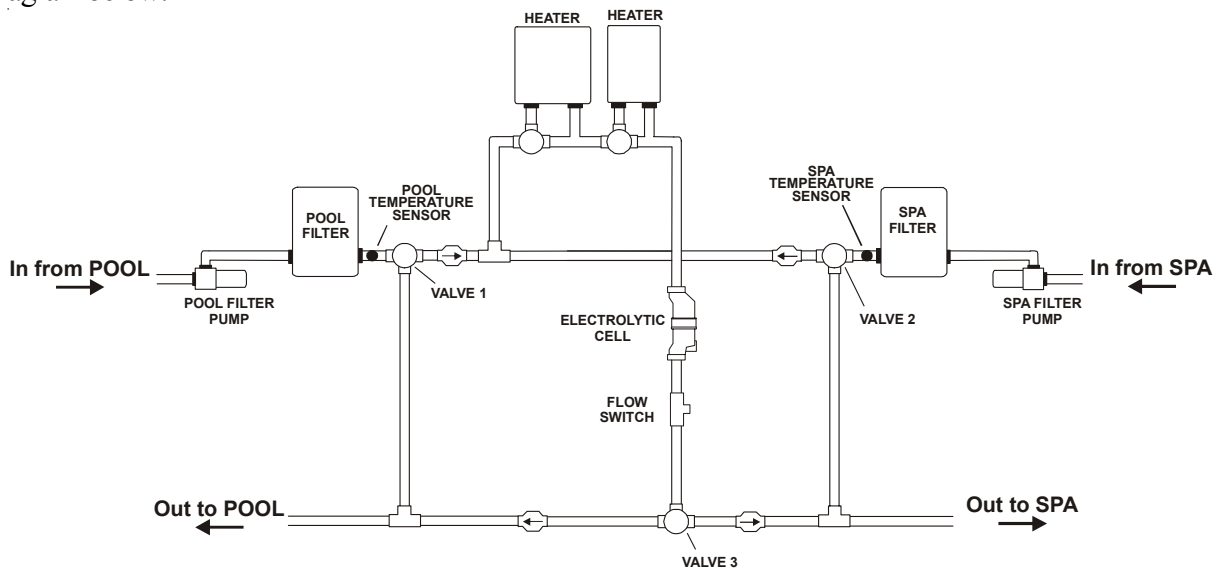

Some important notes regarding the Aqua Logic control of Dual Equipment Pool/Spa systems with shared heaters:

In the Pool/Spa Config., select:

| |
|-------------------------------------|
| Pool/Spa Setup Pool and Spa-Dual |
|-------------------------------------|

| |
|-------------------|
| Heaters Shared |
|-------------------|

1. When dual equipment is selected:
 - a. The “filter” pump automatically is renamed “Pool Filter” and can not be changed. The pool filter can be a one or two speed pump.
 - b. The “Aux1” output is automatically renamed “Spa Filter”, its function is set to “Timeclock” and the Interlock feature is forced to “Disabled”. None of these can be changed. The spa filter can be a one or two speed pump.
 - c. The Valve3 configuration menu is disabled.
 - d. The heater(s) will be dedicated to the spa whenever the spa filter is on and the spa temperature setting is not off.

2. The water sensor should be installed on the pool loop prior to the heater(s) and will display the pool temperature whenever the “Pool Filter” pump is running.
3. The solar sensor should be installed on the spa loop prior to the heater(s) and will display the spa temperature whenever the “Spa Filter” pump is running.
4. Solar heater control is NOT available for dual equipment systems.
5. The Aqua Logic can be programmed to accommodate spillover if desired. Note that spillover operation will be automatically suspended whenever the spa filter pump is turned on.
6. The chlorinator cell and flow switch must be installed in the heater return path. If spillover is enabled, then the Aqua Logic can chlorinate both the pool and spa (during spillover operation). Otherwise, the Aqua Logic will only chlorinate the pool when the spa does not control the heater(s) and the spa sanitization will have to be handled manually.
7. If any water feature or pressure side cleaner boost pumps are used, be sure to enable the “interlock” feature (see “Configuration Menu” for details) to ensure that the pumps operate only when the “Pool Filter” pump is on and the system is in the “pool only” operating mode.
8. The plumbing diagram on page 11 is intended to be used as a general guideline and is not a complete plumbing schematic for the pool.
9. When using the wireless spa-side remote control (AQL-SS-RF), the “POOL” button will position the valves for Pool mode and the “SPA” button will position the valves for Spillover mode.

Turbo Cell (supplied with AQL-CL chlorination kit)

The Turbo Cell (used for chlorine generation) should be plumbed AFTER the filter and heater. If installed on a pool/spa combination system, the cell should be plumbed BEFORE the pool/spa return valve in order to allow proper chlorination of both the pool and the spa. Refer to plumbing diagram below:

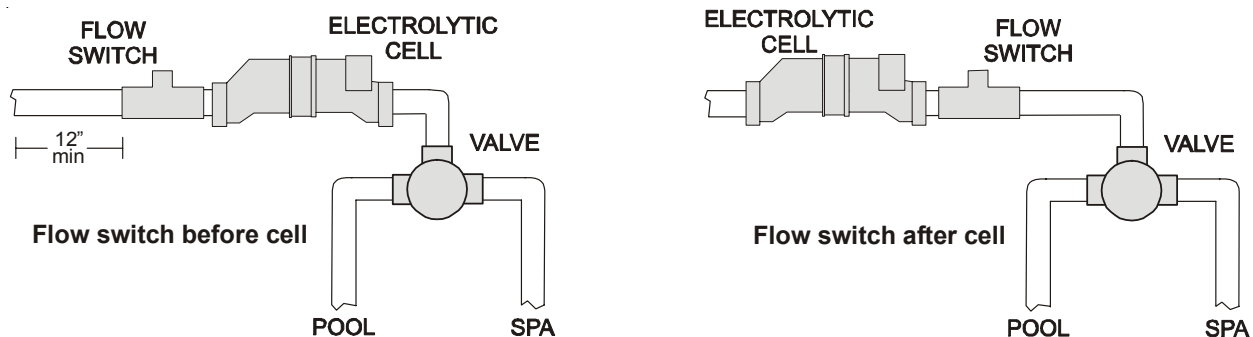

The cell may be mounted vertically or horizontally, and water can move in either direction through the cell. Install using the 2" unions provided. Tighten unions **BY HAND** for a watertight seal. For systems with 1½" plumbing use adaptors (provided by installer).

Flow Switch (supplied with AQL-CL chlorination kit)

The flow switch must be plumbed in the same section of plumbing as the Turbo Cell. The flow switch is a safety device that ensures that water is flowing through the cell before the Aqua Logic starts to generate chlorine. Failure to properly install the flow switch can result in explosive gases accumulating in the pool plumbing system.

⚠ IMPORTANT: There must be at least a 12" (30cm) straight pipe run before (upstream) the flow switch. If the switch is plumbed after the cell, the cell can be counted as the 12" (30cm) of straight pipe.

⚠ IMPORTANT: To ensure proper operation, verify that the arrow on the flow switch points in the direction of water flow.

4. Electrical Wiring

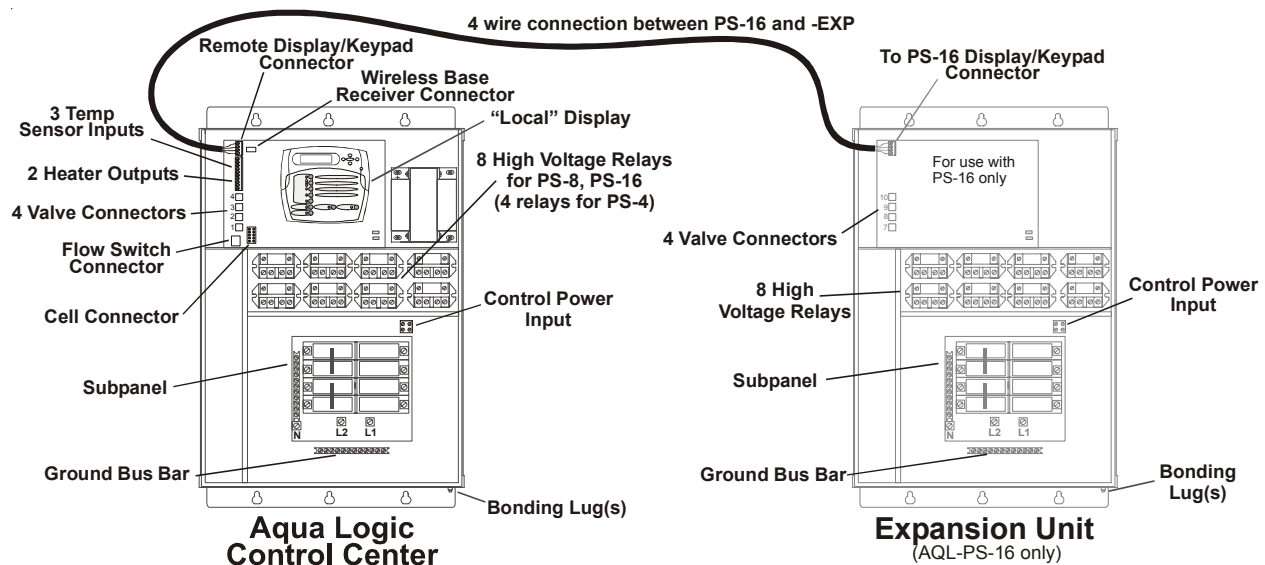

The Aqua Logic Control Center and PS-16 Expansion Unit require both high and low voltage connections. Low voltage connections will be made to actuators, sensors, remote keypad, etc. High voltage connections will be made to pumps, lights, etc., as well as providing direct input power to the Control Center. Always:

- Ensure that Power is disconnected prior to doing any wiring
- Follow all local and NEC (CEC if applicable) codes
- Use copper conductors only

Main Service (Power to the Circuit Breaker Subpanel)

The Aqua Logic circuit breaker subpanel is rated for 100A service. Run properly rated conductors (L1, L2, N, and ground) from the primary house electrical panel to the main power connections on the Aqua Logic circuit breaker base. The connection at the main house panel should be to a 240VAC circuit breaker rated at 100A maximum.

Grounding and Bonding

Connect a ground wire from the primary electrical panel to the Aqua Logic ground bus bar. Also ground each piece of high voltage (120 or 240VAC) equipment that is connected to the Aqua Logic control relays or circuit breakers. The Aqua Logic should also be connected to the pool bonding system by an 8AWG (6AWG for Canada) wire. A lug for bonding (2 for Canada) is provided on the outside/bottom of the Aqua Logic enclosure.

Circuit Breaker Installation and Wiring

Circuit breakers are to be supplied by the installer. See the chart below for a list of suitable circuit breakers that can be used. Follow the code and the circuit breaker manufacturer's rating requirements regarding the size and temperature rating for wiring. Note that some pool equipment may be required to be connected to ground fault circuit breakers—check local and NEC (CEC) codes.

| SUITABLE LISTED BREAKERS | | | | | | |
|--------------------------|--------|--------|------|------|-------|---------------|
| Manufacturer | Single | Double | Twin | Quad | GFCB | Filler Plates |
| Cutler-Hammer | BR | BR | BRD | BRD | GFCB | BRFP |
| Murray | MP-T | MP-T | MH-T | MH-T | MP-GT | LX100FP |
| Siemens | QP | QP | QT | QT | QPF | QF3 |
| Square D | HOM | HOM | HOMT | HOMT | HOM | HOMFP |
| Thomas & Betts | TB | TB | TBBD | TBBQ | GFB | FP-1C-TB |

General Purpose Outlet

If desired, a duplex receptacle with weatherproof cover (supplied by installer) may be installed in the knockouts on the lower right side of the Aqua Logic enclosure. Per code, the receptacle should be a GFCI type. Alternatively, connect a standard receptacle to a GFCB.

Aqua Logic Control Power

The Aqua Logic requires 120VAC, 2A power to operate the control logic circuits and the chlorinator. This power should be connected to one of the circuit breakers.

⚠ WARNING: 120VAC only (permanent damage if connected to 240V)

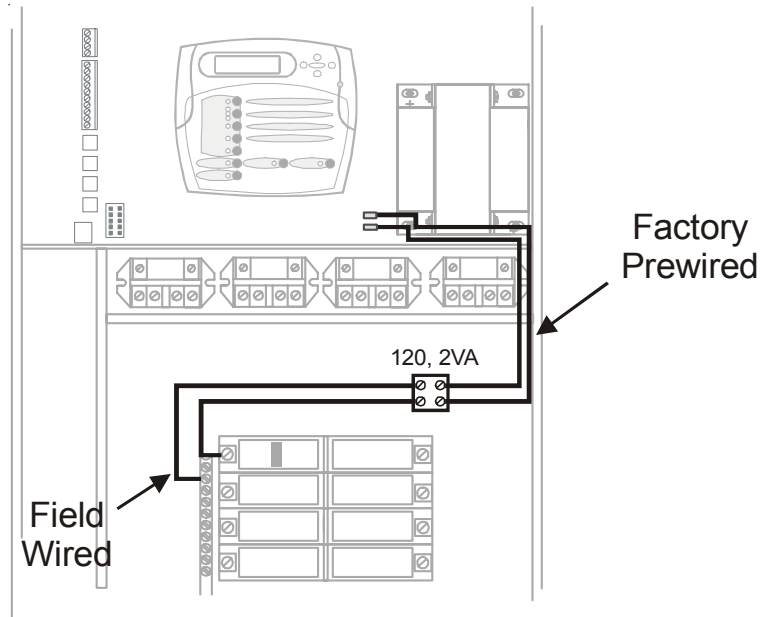

High Voltage (120/240V) Pool Equipment

All Aqua Logic relays are double pole (they make/break both "legs" of 240V circuits) and are rated at 3HP/30A at 240V (1½HP/30A at 120V). Refer to the diagram below for typical relay wiring.

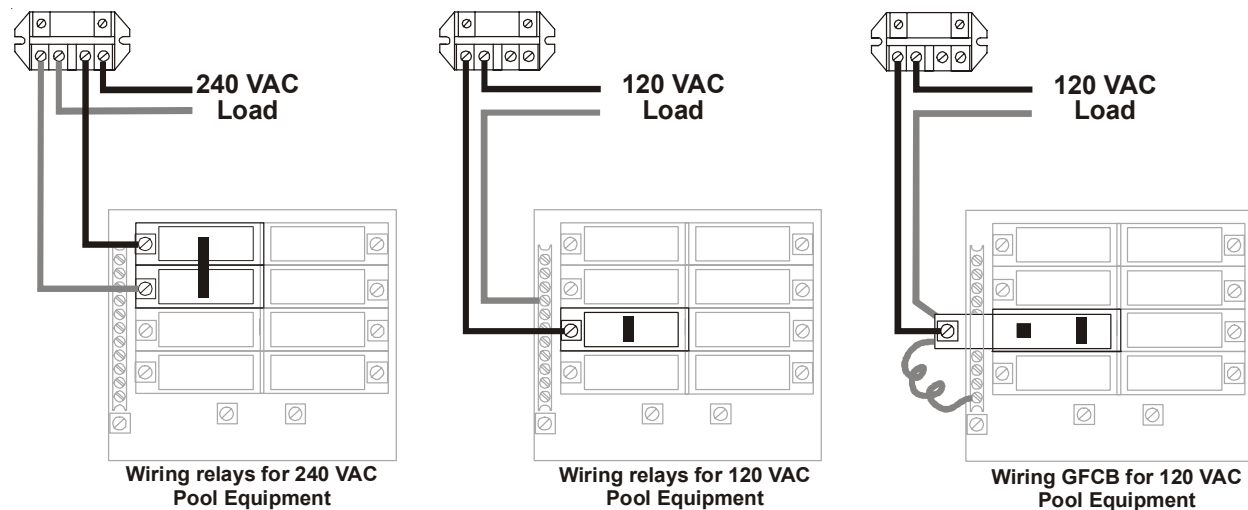

⚠ WARNING: Do not use the Aqua Logic to control an automatic pool cover. Swimmers may become entrapped underneath the cover.

Two speed filter pump: Requires 2 relays (FILTER plus one of the AUX relays) for proper operation of both speeds. **⚠ IMPORTANT: Be sure to follow the wiring diagram below AND to configure the control logic according to the instructions on page 25.**

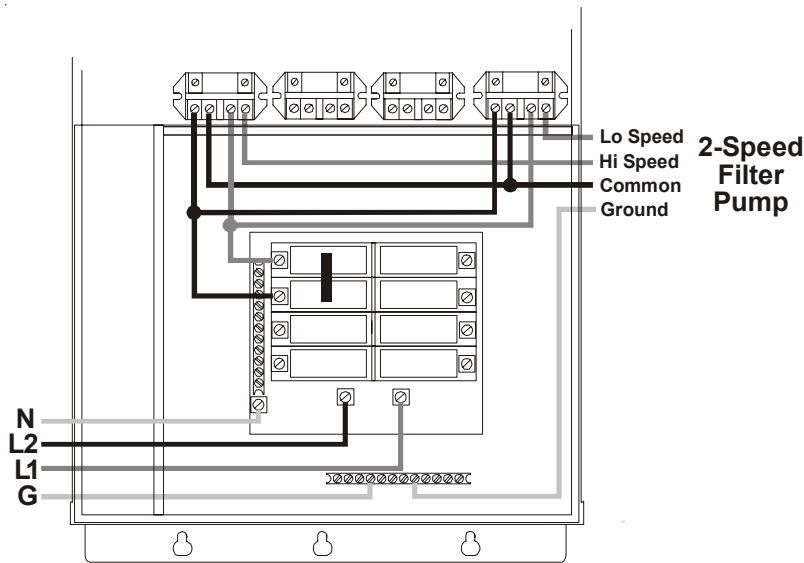

Lights: A ground fault circuit breaker must be used to supply power for high voltage pool/spa lighting. Low voltage lights will require an external transformer. For lighting systems that have both a light source and color wheel, connect the light source to the “Lights” relay and then connect the color wheel to one of the AUX outputs.

Low Voltage Wiring

Valve Actuators

The Aqua Logic can control up to four (PS-4/8) or eight (PS-16) 24V automatic valve actuators. Two of the valve outputs are dedicated to the pool/spa suction (Valve2) and return (Valve1) valves. Valve3 and Valve4 (Valves3, 4, 7-10 for PS-16) are for general purpose use (solar, water feature, in-floor cleaner, etc.).

For installations with solar heating, Goldline offers the AQ-SOL-KIT-xx solar kit that contains a valve, actuator, and extra temperature sensor. The “xx” indicates the valve type from the 2 choices below:

- 1P 1.5” Positive Seal
- 2P 2” Positive Seal

The Aqua Logic is compatible with standard valve actuators manufactured by Hayward, Pentair/Compool, and Jandy. See diagram on page 13 for the location of valve connectors.

Heater Control

The Aqua Logic allows for independent control of up to 2 heaters plus a solar heating system if applicable. A typical use for this feature is on a pool that has both a gas heater (for rapid heating of the spa) and a heat pump (for economical heating of the pool). **IMPORTANT: If you chose to use the “Heater2” control output, then you will not be able to use the “Valve4” output.** These 2 functions use the same internal relay and only one can be enabled. In the configuration menu, if “Heater2” is enabled, then the configuration for “Valve4” will never appear. The heater interface wiring, as described below, is identical for “Heater1” and “Heater2” except for the terminal connections at the Aqua Logic control.

The Aqua Logic provides a set of low voltage dry contacts that can be connected to most gas heaters or heat pumps with 24V control circuits. Refer to the diagram on the following page for a generic connection.

The manuals supplied with most heaters also include specific wiring instructions for connecting the heater to an external control (usually identified as “2-wire” remote control). For millivolt or line voltage heaters, contact Goldline Tech support, 888-921-7665. Refer to the diagrams and the information on the following pages for more details on the connection to several popular heaters.

Generic Heaters

1. Wire heater to 120/240V power source per the instructions in the heater manual. The Aqua Logic does NOT control the power going to the heater.
2. Wire the Aqua Logic dry contact heater output per the diagram below. Many internal parts of the heater can get very hot--see the heater manufacturer’s recommendations on the minimum temperature rating for wires. If no guidance is given, use 105°C rated wire.
3. Set any ON/OFF switch on the heater to ON.
4. Set the thermostat(s) on the heater to the maximum (hottest) setting.

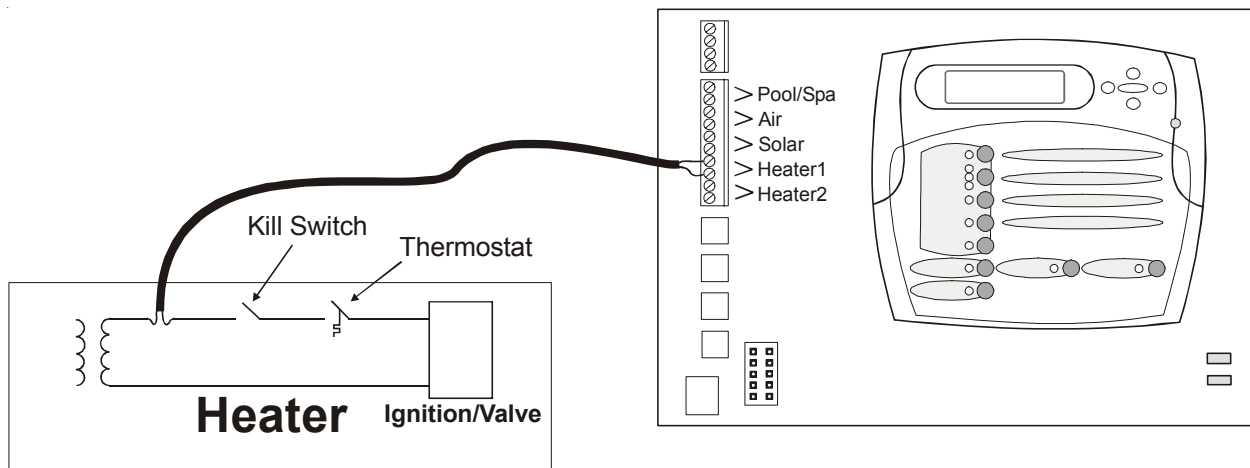

Laars Heaters

1. Turn power off to heater.
2. Remove factory jumper from terminal block.
3. Wire Aqua Logic to the heater as shown.
4. Ensure toggle switch is in the ON position.
5. Set heater thermostats to maximum position.

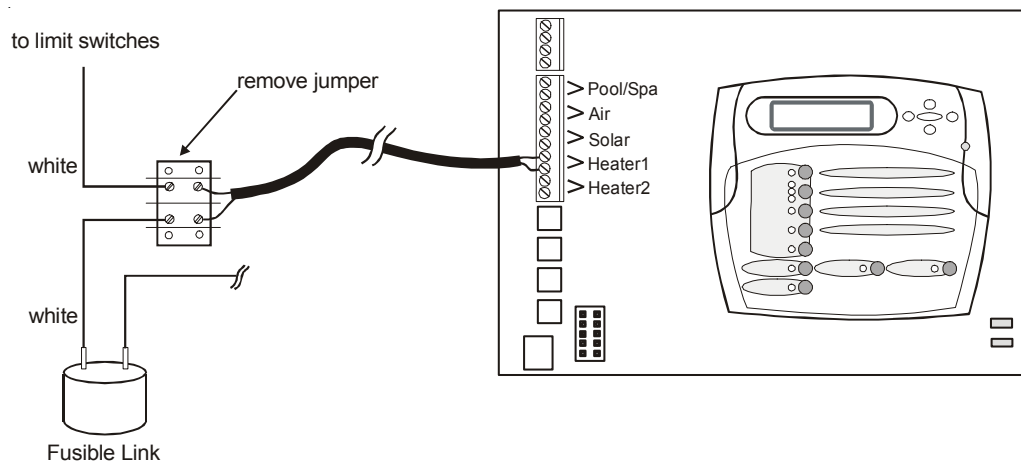

Hayward Heaters

Refer to the instructions in the heater manual for “2-wire Remote Thermostat” operation under “Remote Control Connections” and the diagram on the below:

1. Turn off power to heater.
2. Wire Aqua Logic to terminals 1 & 2 (see diagram).
3. Leave jumper attached to terminals 4 & 5.
4. Move “BYPASS” dipswitch on heater circuit board to “ON” position (up).
5. Turn heater power back on.
6. Switch heater to either “Pool” or “Spa” (it doesn’t make any difference which is selected, the Aqua Logic will take control).
7. Heater display should be “bO” (for “bypass On”).
8. Heater will fire whenever Aqua Logic requests (when Aqua Logic “Heater” LED is illuminated).

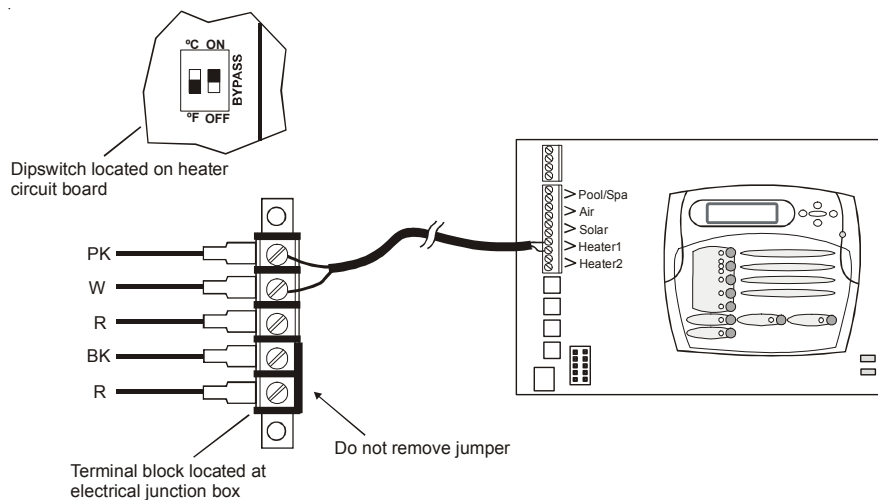

Pentair/Purex/MiniMax

1. Turn power off to heater.
2. Remove factory installed jumper from the “Ext Switch” connector.
3. Wire the Aqua Logic to the “Ext Switch” connector as shown below.
4. The wires to the Aqua Logic must be separated from any line voltage wires. Failure to follow these instructions may cause erratic operation of the heater.
5. Set the Power (Thermostat Select) switch to either “Pool” or “Spa”.
6. Set the “Pool” and “Spa” thermostats to their maximum settings.

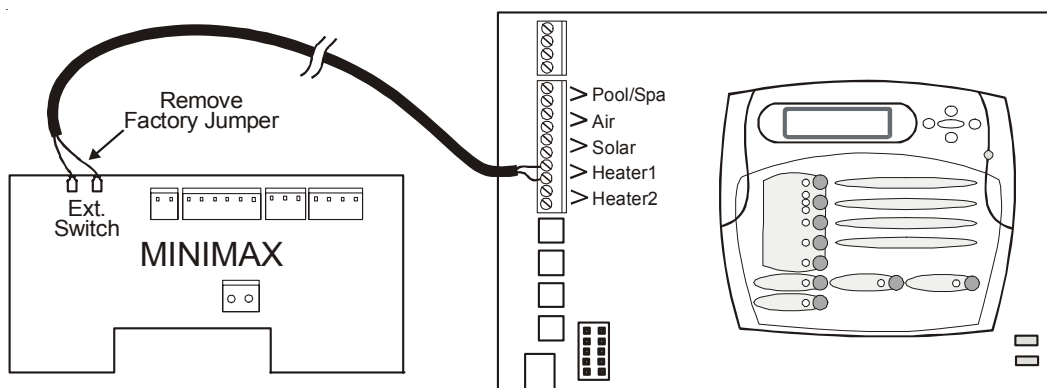

Raypak RP2100 Pool/Spa Heater

1. Turn power off to heater.
2. Push the mode button to “spa” mode.
3. Set the temperature to the maximum.
4. Push the mode button to “OFF”.
5. Lastly, plug the prewired connector in the P7 position on the board.

⚠ IMPORTANT: The heater will display “OFF” when it is being remotely controlled by the Aqua Logic. Some homeowners see the “OFF” display and, thinking this is a mistake, change the mode to “POOL” or “SPA” which then disables the remote control by the Aqua Logic. To prevent this: Remove the heater touch pad connector (P5) which will disable the touchpad.

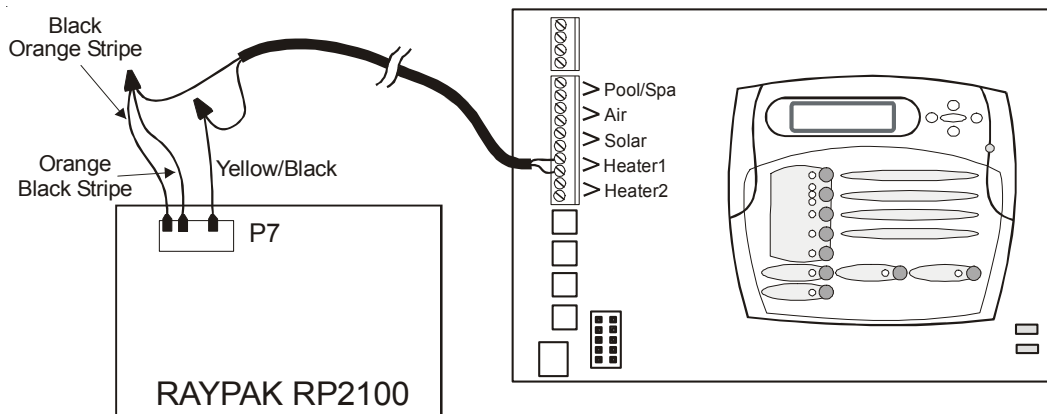

STA-RITE Heater

1. Turn power off to heater.
2. Remove upper jacket and open the control box.
3. Remove the jumper for the “fireman’s switch”.
4. Wire to the Aqua Logic using wire rated for 105°C minimum.

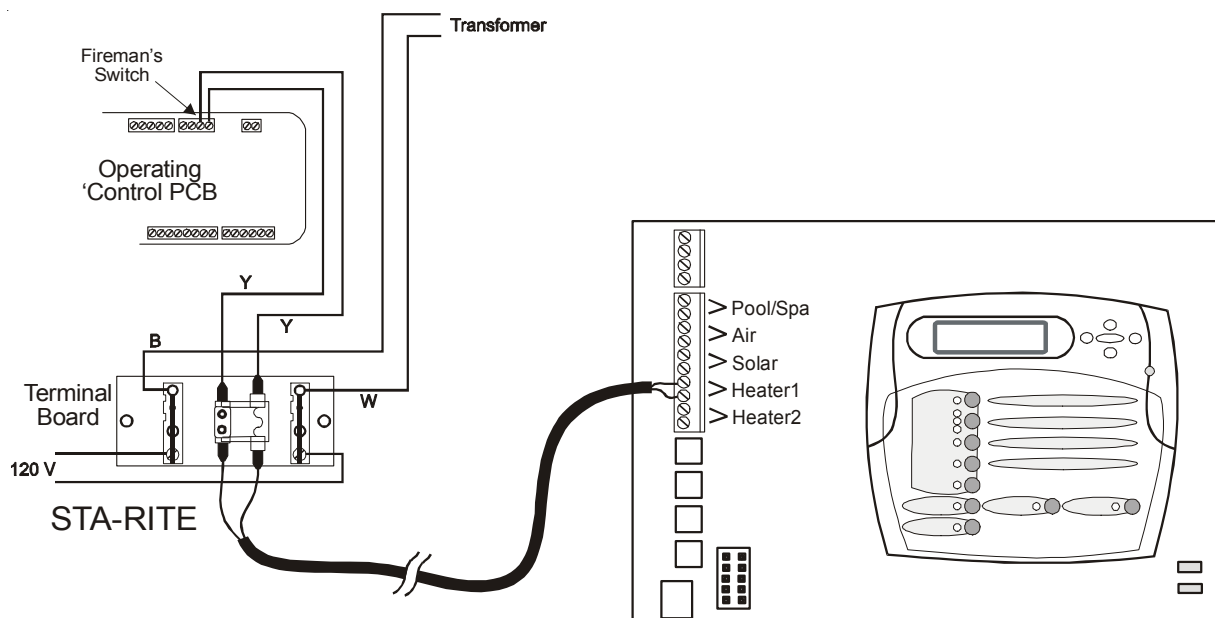

Temperature Sensors

The Aqua Logic utilizes 10K ohm thermistor type sensors. Three sensors (water temperature, air temperature and solar temperature (spa temperature for “Pool and Spa-Dual”)) are included. If the Aqua Logic is being used to control a solar heating system, the solar sensor is required. The sensors are provided with a 15 ft. cable. If a longer cable is required, contact the Goldline service dept. (888-921-7665) for information on suitable cable types and splices. See Temperature Sensors on page 6 for directions on installing the sensors.

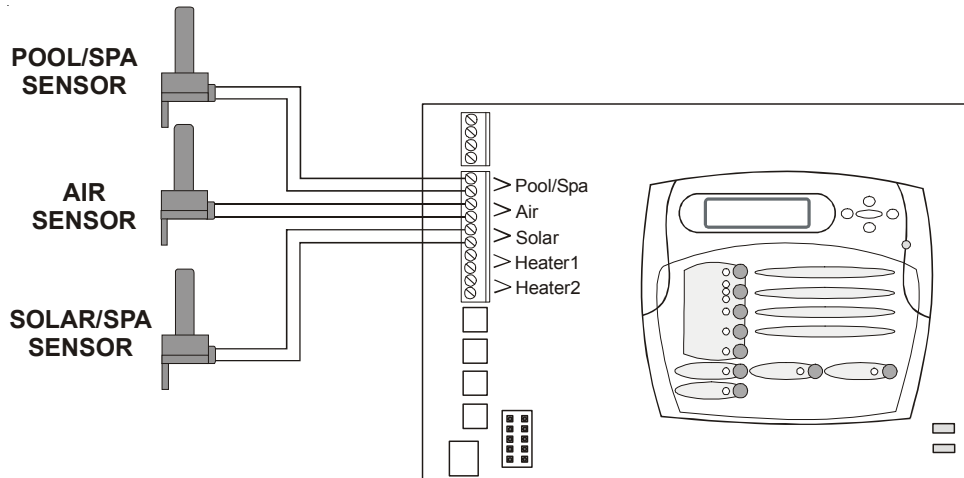

Wired Remote Display/Keypad

The Aqua Logic main unit can connect to a maximum of 3 remote wired display/keypads. One remote wired display/keypad is included with the Aqua Logic, additional wired display/keypads must be ordered separately.

Use four conductor cable (typically phone cable) to connect the wired remote display/keypad with the Aqua Logic Control Center as shown below. The maximum wiring distance is 500ft. (160m). Note that the terminals on both the Aqua Logic main unit and the wired remote display/keypad are numbered: Connect 1 to 1, 2 to 2, etc. Refer to diagram below.

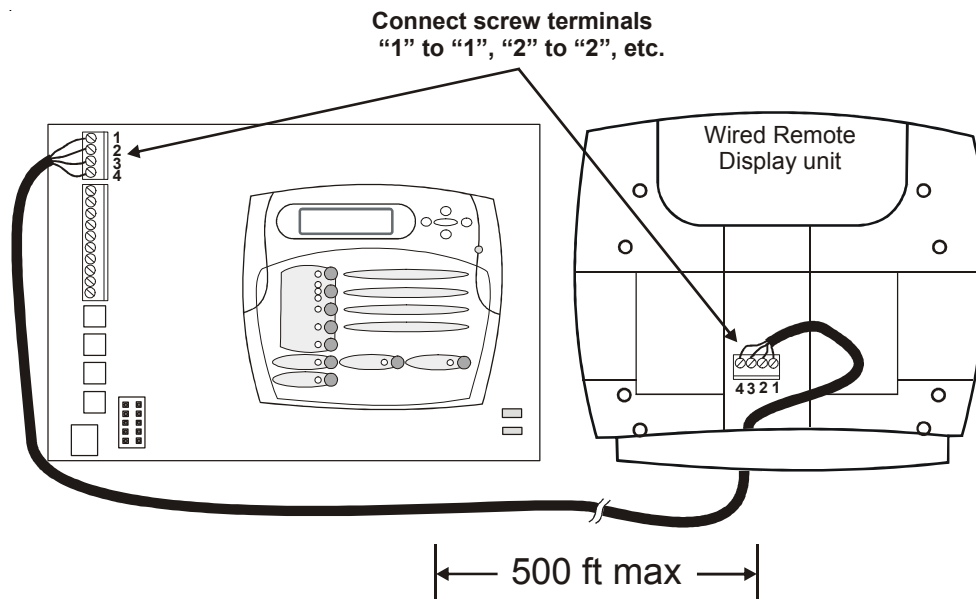

If multiple remote display/keypads are installed: Never connect more than 2 wires to any terminal block. Two remotes can be wired back to the Aqua Logic main unit or the second display/keypad (and third, if applicable) can be “daisy chained” with one display/keypad wired to the next. The maximum wire run from the Aqua Logic main unit to the furthest remote display/keypad is 500 ft (160m).

Base Station

Plug in the pigtail connector from the wireless base station into the “wireless” connector on the main PCB in the Aqua Logic control unit.

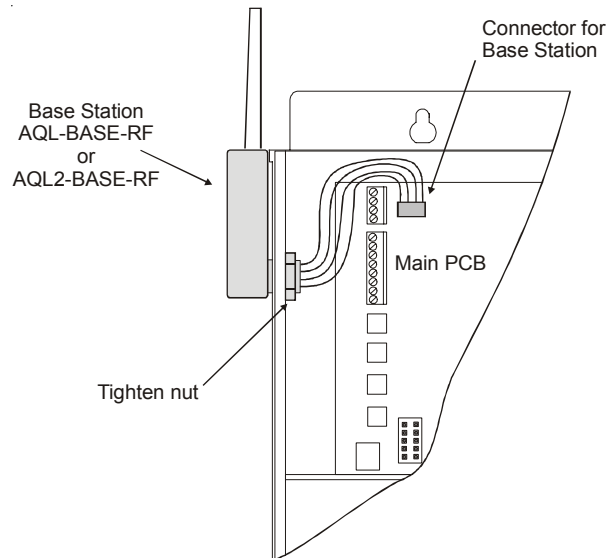

PS-16 Expansion Unit

Use four conductor cable (typically phone cable) to connect the PS-16 Expansion Unit to the Aqua Logic Control Center as shown below. Note that the terminals on both the Aqua Logic main unit and the PS-16 Expansion Unit are numbered: Connect 1 to 1, 2 to 2, etc. Refer to diagram below.

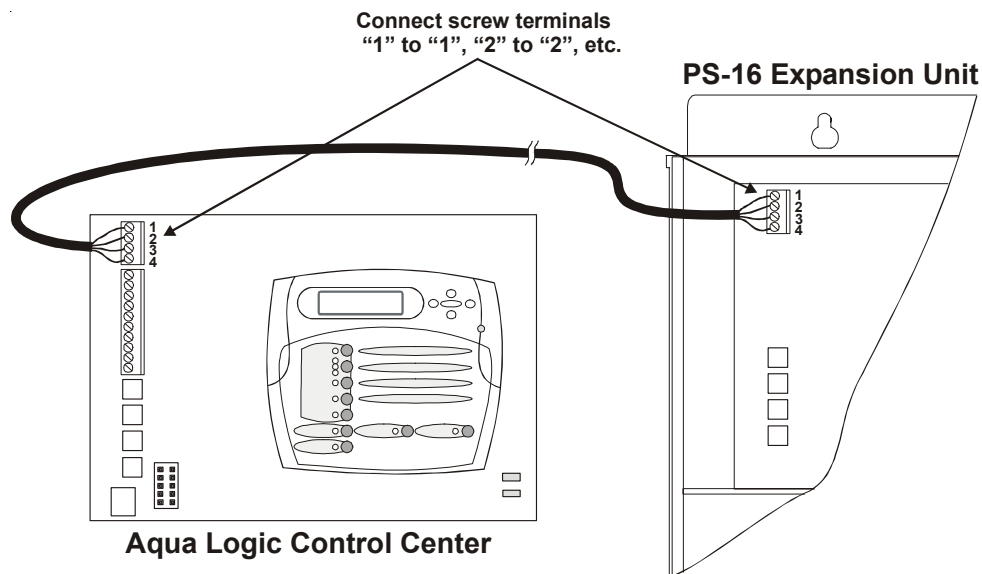

Flow Switch

Only applicable if the chlorinator function is enabled and/or the flow monitor feature is desired. The flow switch cable plugs into the Aqua Logic Control Center at the position shown in the diagram on page 13. Ensure that the connector catch “snaps” in order to provide a reliable connection.

Turbo Cell

Only applicable if the chlorinator function is enabled. The Turbo Cell should be plugged in after the Aqua Logic cover panel is put back in place. Refer to page 13 for the location of the connector.

Goldline Aqua Rite Chlorinator

The Aqua Logic can control one or more Goldline Aqua Rite chlorinators when additional sanitizing capacity is required. A 4 wire connection is used to communicate to the Aqua Rite and can be wired up to 500' apart. Any outdoor rated 4 conductor cable can be used. Refer to the wiring diagrams below for proper wiring connection to the Aqua Rite. NOTE: There must be only 1 "primary" unit. All other Aqua Rite units must be configured as "secondary".

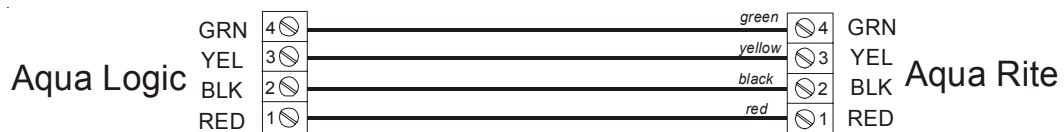
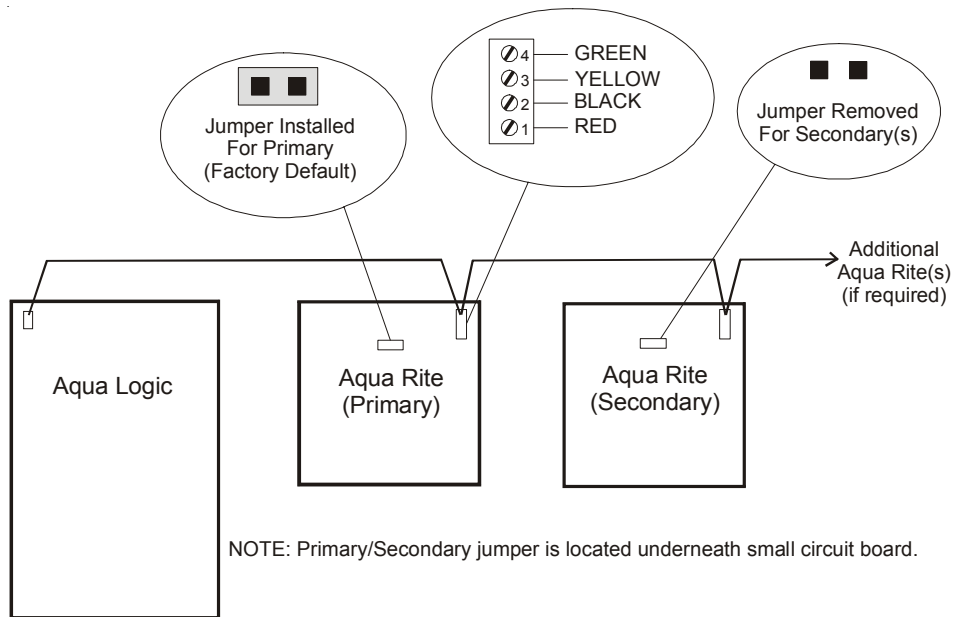

5. Configuration Setup

After plumbing and wiring are complete, the Aqua Logic **MUST BE CONFIGURED** before attempting to operate. Configuration information is entered at the keypad and “tells” the Aqua Logic what equipment is connected and how each should be controlled.

Group Function

The latest version of the Aqua Logic offers the ability to assign a Group function to a particular button. Instead of a button controlling one particular function, the button can be programmed to initiate a sequence of commands that are programmed in the Configuration Menu. For example, instead of the Lights button turning on and off the pool light only, the button can be programmed to turn on the pool light, turn on the bug light, turn off the pool cleaner, turn on and dim the patio lights, turn on the music, etc. all at the same time. This convenient feature is offered on all Aux buttons, both Valve buttons and the Lights button. Refer to this section when programming Group commands.

Before assigning and configuring all the desired functions and their control parameters, the group itself must be configured. The options for controlling groups are Manual On/Off, Countdown Timer, and Timeclock. The group will turn on and off based on this selection.

When setting up a Group function in the Configuration Menu, the first menu allows you to select the control parameter (how the group is activated and de-activated) and the second menu allows you to select which Aqua Logic functions are to be controlled in the group.

A table of functions and their corresponding control parameters are listed below.

| Function | Control Parameter |
|---|--|
| Pool/Spa | Unaffected, Pool only, Spa only, or Spillover |
| Pool Filter | Unaffected, Off, On, High speed, or Low speed |
| Lights <small>(standard relay)</small> | Unaffected, Off, or On |
| Lights <small>(dimmer relay)</small> | Unaffected, Off, On, 100%, 80%, 60%, 40%, or 20% |
| Spa Filter | Unaffected, Off, On, High speed, or Low speed |
| Aux1-14 <small>(standard relay)</small> | Unaffected, Off, or On |
| Aux1-14 <small>(dimmer relay)</small> | Unaffected, Off, On, 100%, 80%, 60%, 40%, or 20% |
| Valve3 | Unaffected, Off, or On |
| Valve4 | Unaffected, Off, or On |
| Spa Htr1 Set | Unaffected, Off, 65°-104°F |
| Pool Htr1 Set | Unaffected, Off, 65°-104°F |
| Spa Htr2 Set | Unaffected, Off, 65°-104°F |
| Pool Htr2 Set | Unaffected, Off, 65°-104°F |
| Spa Solar Set | Unaffected, Off, 65°-104°F |
| Pool Solar Set | Unaffected, Off, 65°-104°F |
| SuperChlr | Unaffected, Off, On |

Note that all functions in the table may not be offered. The available functions are dependent on how the Aqua Logic is configured. For example, if the Aqua Logic is configured for a single heater, “Heater2” will not be available as an option in the Group menu. Also, under some circumstances, functions will be displayed but can’t be changed. Note that the function whose menu you are in, will not be displayed as an option and will automatically turn on when the group is activated. For example, if programming a Group function under the Lights menu, the Lights function will not be offered as an option and the Lights function will automatically turn on with the group.

The available control parameters vary with each function. All functions offer “Unaffected”, which should be selected if you do not wish to control that particular function within the group. All other parameters will depend on the particular function selected.

When activating Group functions, be aware that the most recent Group function that you activate will override any previous Group functions.

Heater Setpoints in Groups

The Aqua Logic can be programmed to use alternate heater setpoints (conventional and/or solar) while running group commands. This allows the heater to be set to a higher or lower temperature than normal, while the group is activated. When the group stops, the setpoint will return to its normal setting.

Changing the setpoint while the Group is running will make the Group release the alternate setpoint control and revert back to the normal heater setting. Any changes that are made at that point will affect the normal heater setting. The next time the Group is activated, the temperature will return to the group setpoint that was originally programmed in the Configuration Menu. To change the setpoint while the Group is running, go to the Settings menu and press the +/- button while “Group Control” is displayed. The setpoint will change and be retained as the new normal heater setpoint.

Super Chlorinate

The Aqua Logic can be programmed to Super Chlorinate the pool or spa while running a group command. When the Group starts, the Super Chlorinate cycle will begin. Super Chlorinate will continue until the preset time expires (see Timers Menu/Super Chlorinate Hours) or until the Group turns off. Changing the Super Chlorinate state using the Settings Menu, the Aqua Pod Super Chlorinate button, or a Super Chlorinate assigned Aux/Lights/Valve button will temporarily cancel the Group’s control of Super Chlorinate until the next time the Group is activated.



PS-8 and PS-16 Virtual Models

Aqua Logic Virtual models are similar to standard PS models, but offer additional auxiliary outputs with limited functionality. The AQL-PS-8-V is similar to the AQL-PS-4 with 4 additional Aux outputs. The AQL-PS-16-V is similar to the AQL-PS-8 with 8 additional outputs. The additional aux outputs on virtual models can only be assigned to the Super Chlorinate function (if the Chlorinator is enabled) or to a Group function. Refer to the following programming information when assigning functions to the virtual auxiliary outputs.

Accessing the Configuration Menus

Configuring the Aqua Logic requires that you navigate through the Configuration Menu and input various information. For more detailed information about using the Aqua Logic menu system, refer to the Operation Manual.









To access the Configuration Menus

| | |
|--------------------------------|---|
| Configuration Menu-Locked |  Press repeatedly until "Configuration Menu" is displayed |
| |  Press BOTH buttons SIMULTANEOUSLY for 5 seconds to unlock |
| Configuration Menu-Unlocked |  Move to configuration menu items |

NOTE: The configuration menu automatically "locks" after 2 minutes of no buttons being pressed to prevent unauthorized people from changing the control logic inadvertently and possibly damaging the pool equipment or causing a "call back" to fix the configuration.

Configuration Menus

Each item needs to be programmed and may contain additional sub-menu items. Refer to the following pages for information on programming.

| | |
|------------------------------------|---|
| Chlor. Config. + to view/change |  Push to access Chlorinator option |
| |  Move to next configuration menu |
| Chlorinator Enabled |  Toggle between Chlorinator Enabled (default) and Disabled |
| |  Move to next menu item |
| Display Salt |  Toggle between Display Salt (default) and Minerals |
| |  Move to previous/next configuration menu |
| Cell Type T-CELL-15 |  Toggle between T-CELL-5 and T-CELL-15 |
| |  Move to next menu item |

Chlorinator

If the chlorinator is enabled (requires the use of the AQL-CL chlorination kit), then the cell and flow switch must also be installed and the Aqua Logic will automatically chlorinate both the pool and spa according to the desired output setting (see Settings Menu in the Operation manual). If disabled (default), then neither the cell nor flow switch need to be installed and all displays relating to the chlorinator will be suppressed.































When the chlorinator is enabled, the Aqua Logic will automatically detect and control any Aqua Rite(s) that is installed in the system (see page 21).

Display

Allows for the display of salt (default) or mineral values.

Cell Type Selection

The Cell Type Menu appears after "Display Salt/Minerals" in the Chlorinator Configuration Menu. The options are T-CELL-5 or T-CELL-15 (default). Make the proper selection based on the electrolytic cell that is used in your system. For pools up to 20,000 gallons, the T-CELL-5 is typically used. The T-CELL-15 is for pools up to 40,000 gallons.

| | |
|--|---|
| Pool/Spa Config. + to view/change |  Push to access Pool/Spa options   Move to previous/next configuration menu |
| Pool/Spa Setup Pool and Spa-Std |   Rotates between Pool and Spa-Std (default), Pool and Spa-Dual, Pool Only, and Spa Only options   Move to next menu item |
| <i>if "Pool and Spa-Dual" is selected</i> | |
| Heaters Htr1=Spa, Htr2=Pool |   Toggle between Htr1=Spa, Htr2=Pool (default) and Shared Heaters   Move to next menu item |
| <i>if "Pool and Spa-Std" is selected</i> | |
| Spa - CountDn 00:30 |   Adjust time setting (Manual On/Off, 0:05, 0:10, 0:15..., (default is 4:00))   Move to next menu item |
| <i>if "Pool and Spa-Std or Dual" is selected</i> | |
| Spa Spillover Enabled |   Toggle between Enabled and Disabled (default) Spa Spillover   Move to next menu item or previous/next configuration menu |
| <i>if "Pool and Spa-Std or Dual" is selected and if "Spa Spillover" is enabled</i> | |
| Filter Operation Spa Spillover |   Toggle between Pool Only (default) and Spa Spillover options   Move to previous/next configuration menu |
| <i>if "Pool Only" or "Spa Only" is selected</i> | |
| V1=Aux1, V2=Aux2 Disabled |   Toggle between Enabled and Disabled (default)   Move to previous/next configuration menu |
| <i>if "Pool and Spa-Std" is selected</i> | |
| Filter Off Valve Change: Enabled |   Toggle between Enabled (default) and Disabled   Move to previous/next configuration menu |

Pool/Spa Setup

If "Pool Only" or "Spa Only" are selected, then the pool/spa valves are not needed and pushing the POOL/SPA button on the display/keypad will have no effect. If "Pool and Spa-Std" is selected, then the pool/spa suction and return valve actuators should be connected to the Aqua Logic. Pressing the POOL/SPA button on the display/keypad will allow the homeowner to alternate between pool and spa operation. If "Pool and Spa-Dual" is selected, then only the Pool/Spa return valve actuator should be connected to the Aqua Logic.

For more information on "Pool and Spa-Std" and "Pool and Spa-Dual", refer to Section 3, Plumbing, on pages 9-12.

Heaters

This menu will only appear if Pool/Spa setup is set to "Pool and Spa-Dual". This allows the heater(s) to either be shared between the pool and spa ("Shared" selected) or for Heater1 to be dedicated to the spa and Heater2 to be dedicated to the pool ("Htr1=Spa, Htr2=Pool" selected).

Spa CountDn

This menu will appear only if Pool/Spa Setup is set to "Pool and Spa-Std". This setting is the time, after you manually switch the Pool/Spa valves to "Spa Only", until the Aqua Logic automatically returns the valves to their previous positions. It is programmed in increments of 5 minutes, from "Manual On/Off" (0 minutes) to "21:00" (21 hours). The filter is forced on during this time period.

Spa Spillover

When spa spillover is "Enabled" and "Pool and Spa-Std", the homeowner will be able to rotate through "Pool Only" (both suction and return valves switched to pool), "Spa Only" (both suction and return valves switched to spa) and "Spillover" (suction valve switched to pool and return valve switched to spa) by successive presses of the "Pool/Spa" button. For "Pool and Spa-Dual", only "Pool Only" and "Spillover" are available.

Filter Operation

If “Spa Spillover” is selected, the Aqua Logic will automatically switch the pool/spa suction and return valves to “spillover” at the start of the programmed pool filtering time period or when the super-chlorinate function is turned on. The valves will remain in this position for the remainder of the super-chlorinate period. This option is usually preferable because both the pool and spa water will be filtered and sanitized.























If “Pool Only” is selected, then the Aqua Logic will switch the pool/spa valves to the “pool only” position at the start of the programmed pool filtering time period or when the super-chlorinate function is turned on. This may be desirable on some systems with in-floor cleaners because it allows the cleaner to operate all the time the pool is being filtered and/or the super chlorinate is running.

V1=Aux1, V2=Aux2

This menu appears only if the Pool/Spa Setup is “Pool Only” or “Spa Only”. When enabled, Valve 1 (return) will follow the Aux1 output and Valve 2 (suction) will follow the Aux2 output. When disabled (default), the return and suction pool/spa valves function normally.

Filter Off Valve Change

This menu appears only if Pool/Spa setup is set to “Pool and Spa”. When enabled (default), the filter pump will shut off for 35 seconds whenever the Pool/Spa valves are turning. The pump will NOT shut off when the heater has Cooldown enabled and is either on or in the Heater Cooldown mode.

| | |
|--|---|
| Filter Pump Config. + to view/change |  Push to access pump options   Move to previous/next configuration menu |
| Filter Name Pool Filter |  Rotates between all available names   Move to next menu item |
| Filter Pump 1 Speed |   Toggle between 1-speed (default) and 2-speed options   Move to next menu item |
| Flow Monitor Disabled |   Toggle between Enabled and Disabled (default) Flow Monitor   Move to next menu item |
| Freeze Protect Enabled |   Toggle between Enabled (default) and Disabled Freeze Protection   Move to next menu item or previous/next configuration menu |
| <i>if “Freeze Protect” is enabled</i> Freeze Temp 38°F |   Adjust the desired freeze protection temperature (33°F - 42°F)   Move to previous/next configuration menu |

Filter Name

The Aqua Logic allows you to assign any one of a number of names (e.g. “Filter Pump, Pool Filter, Spa Filter, etc.) to the filter relay. This will make the Aqua Logic more user friendly to the homeowner when they want to control the filter equipment. A sheet of small name labels is included with the Aqua Logic main unit and each remote display/keypad so that appropriate pushbuttons can be labeled the same as the name that you have assigned.

Filter Pump

For 2-speed pumps: When a 2-speed pump is configured, one of the AUX relays must also be configured to control the low speed motor winding on the pump (see page 14 for wiring and page 31 for AUX configuration). See the Operation manual for specific information regarding the control logic for 2-speed pump operation.

Flow Monitor

This feature will help protect the filter pump from damage due to no flow. When used with a Goldline flow switch, the Aqua Logic monitors the state of water flow when the filter pump is on. If no flow is detected for more than 15 minutes, the Aqua Logic will shut down the pool pump and the “Check System” LED will indicate an error. The error will be cleared the next time the pump is turned on.

Freeze Protection

Freeze protection is used to protect the pool and plumbed equipment against freeze damage. If freeze protection is enabled and the AIR temperature sensor falls below the freeze threshold (see below), the Aqua Logic will turn on the filter pump to circulate the water. If “Pool and Spa” is selected in the Pool/Spa sub-menu (see page 24), the valves will also alternate between the pool and spa every 30 minutes and the filter pump will turn off while the valves are turning. The chlorinator will not operate if freeze protection is the only reason the pump is running.

Freeze Protection Temperature

Select the temperature to be used for freeze protection. Temperature is adjustable from 33°F - 42°F (1°C - 6°C). 38°F (3°C) is default. This threshold will be used for all outputs that have freeze protection enabled.

NOTE: Heater1 and Heater2 configuration are identical. If Heater2 is enabled then Valve4 will automatically be disabled due to the fact that they use the same output relay and only 1 function can be assigned to that relay.

| | |
|--|--|
| Heater1 Config. + to view/change | + Push to access heater options < > Move to previous/next configuration menu |
| Heater1 Disable | + - Toggle between Enabled and Disabled (default) Heater 1 < > Move to next menu item or previous/next configuration menu |
| <i>if “Heater1” is enabled</i> Heater1 Name Gas Heater | + - Rotates between all available names < > Move to next menu item |
| <i>if “Heater1” is enabled</i> Heater1 Cooldown Disabled | + - Toggle between Enabled and Disabled (default) Heater 1 Cooldown < > Move to next menu item |
| <i>if “Heater1” is enabled</i> Heater1 Extend Disabled | + - Toggle between Enabled and Disabled (default) Heater 1 Extend < > Move to previous/next configuration menu |
| <i>if “Heater1” is enabled and 2-speed filter pump is enabled</i> Allow Low Speed Disabled | + - Toggle between Enabled and Disabled (default) < > Move to next menu item or previous/next configuration menu |

Heater1

If the heater is “Enabled”, the heater relay will turn on when the water temperature is less than the desired temperature setting and the filter pump is running. The desired temperature is in the “Settings Menu”. If applicable, the homeowner will be prompted to enter separate “pool” and “spa” settings. Depending on the position of the pool/spa suction valves, the proper temperature setting will be used.

Heater Name

The Aqua Logic allows you to assign any one of a number of names (e.g. “Gas Heater, Heat Pump, etc.) to each of the heater control functions. This will make the Aqua Logic much more user friendly to the homeowner when they want to turn various heaters on or off or set

temperatures. A sheet of small name labels is included with the Aqua Logic main unit and each remote display/keypad so that appropriate pushbuttons can be labeled the same as the name that you have assigned.

Heater Cooldown

This feature ensures that the heater cools down before water circulation is stopped. When enabled, the Aqua Logic will continue to run the filter pump for 5 minutes after the heater turns off. During this period the filter pump LED will flash and also a “Heater Cooldown, X:XX remaining” message will scroll on the display.

When the filter pump is running and the heater is on: Pressing the “Filter” button once will cause the heater to turn off, but the filter pump will continue to run for heater cooldown (filter LED flashing and message on display). Pushing the filter button a second time will override the heater cooldown operation and turn the filter pump off.

For a Pool/Spa Setup selection of “Pool Only”, “Spa Only” or “Pool and Spa-Std”, Heater1 and/or Heater2 cooldown affect the filter pump. For “Pool and Spa-Dual”, Heater1 is associated with the spa filter and Heater2 with the pool filter.

Heater Extend

If “Enabled”, the filter extend logic keeps the filter pump running beyond the normal turn-off time until the pool (or spa) is heated up to the desired temperature setting (see Settings Menu). Heater extend will NOT cause the filter pump to turn on, it will only delay the turn off time when the heater is operating.

For a Pool/Spa Setup selection of “Pool Only”, “Spa Only” or “Pool and Spa-Std”, Heater1 and/or Heater2 will keep the filter pump running. For “Pool and Spa-Dual”, Heater1 will keep the spa filter running and Heater2 will keep the pool filter running.

Allow Low Speed

This menu only appears if the pool filter is configured for 2-speed operation. During default operation, high speed mode is used whenever the heater is on. If Allow Low Speed is enabled, low speed will be allowed even if the heater is on.

| | |
|--|---|
| Solar Config. + to view/change | + Push to access solar options < > Move to previous/next configuration menu |
| Solar Disabled | + - Toggle between Enabled and Disabled (default) Solar < > Move to next menu item or previous/next configuration menu |
| <i>if “Solar” is enabled</i> Solar-Extend Disabled | + - Toggle between Enabled and Disabled (default) Solar Extend < > Move to next menu item |
| <i>if “Solar” is enabled</i> Solar Priority Disabled | + - Toggle between Enabled and Disabled (default) Solar Priority < > Move to previous/next configuration menu |

Solar

The Solar configuration menu will **NOT** appear if “Pool and Spa - Dual” has been selected in the Pool/Spa setup menu. If the solar control logic is “Enabled”, several additional steps must be taken to ensure proper operation of the solar heating system. If the solar is operated by a valve, then a valve (Valve3 or Valve4) output must be setup for solar logic (page 29). If the solar is operated by a pump, then one of the AUX relays must be set up for solar logic (page 31). Also, the “solar” temperature sensor must be installed. This sensor is typically mounted near the collector array and is used to sense whether sufficient solar heat is available.

























If solar is “Enabled”, the valve or solar pump relay will turn on when the water temperature is less than the desired temperature setting AND the solar sensor is hotter than the water by at least 8°F. The desired temperature is in the “Settings Menu”. If applicable, the homeowner will be prompted to enter separate pool and spa desired temperature settings. Depending on the position of the pool/spa suction valve, the proper temperature setting will be used.

Solar Extend

If “Enabled”, the filter extend logic keeps the filter pump running beyond the normal turn-off time if solar heat is still available. When solar heat is no longer available, both the solar valve/pump and filter pump will turn off simultaneously. Solar extend will NOT cause the filter pump to turn on, it will only delay the turn off time when solar is operating.

Solar Priority

If both “Solar Control” and “Heater Control” are enabled, the Solar Priority feature will keep the conventional heater off whenever solar heat is available. This provides the most cost effective way of heating the pool. When solar heat is not available, the conventional heater will operate normally.

| | |
|---|---|
| Lights Config. + to view/change |  Push to access Lights options   Move to previous/next configuration menu |
| Lights Name Pool Light |  Rotates between all available names   Move to next menu item |
| Lights Function Manual On/Off |  Rotates between Manual On/Off (default), Countdown Timer, Low Speed-Filter, Timeclock, Solar, Low speed-Spa Filter, Group, and Super Chlorinate   Move to next menu item |
| <i>for manual on/off, countdown timer and timeclock functions</i> | |
| Lights Relay Standard |  Toggle between Standard (default) and Dimmer   Move to next menu item or previous/next configuration menu |
| <i>for all functions except solar, dimmer relay, low speed (filter pump), and group</i> | |
| Lights Interlock Disable |  Toggle between Enabled and Disabled (default) Lights Interlock   Move to next menu item |
| <i>for group function only</i> | |
| Lights Group Timer: None(Manual) |  Rotates between Manual On/Off (default), Countdown Timer and Timeclock   Move to next menu item |
| <i>for group function only</i> | |
| Lights Group Filter: Unaffected |  Options available depend on the function that is selected   Move to previous/next menu item or next configuration menu |
| <i>for all functions except dimmer relay, low speed, and group</i> | |
| Lights Freeze Disable |  Toggle between Enabled and Disabled (default) Lights Freeze   Move to previous/next configuration menu |

Lights Name

The Aqua Logic allows you to assign any one of a number of names (e.g. “Pool Light, Spa Light, Deck Light, etc.) to this control function. Note that other lights may be assigned to other Aux outputs. This will make the Aqua Logic much more user friendly to the homeowner when they want to turn various lights on or off. A sheet of small name labels is included with the Aqua Logic main unit and each remote display/keypad so that the “Lights” pushbutton can be labeled the same as the name that you have assigned. At this time it is also a good idea to make sure that the relay in the control box is also labeled (hand written) with the same name as a help to technicians who may service this system at a later date.

Lights Function

Although designated as the “Lights” output, the function of the lights relay is similar to the Aux relays. If pool lights are wired to the lights relay, some options including Solar function, Low Speed of a 2-Speed Filter Pump, Lights Interlock and Lights Freeze Protection are not applicable and should be disabled. If no pool lights are used, the lights relay can be used to control other pool devices that may require these options. The function of each option is shown below.

Manual On/Off—the lights relay will alternate between turning on and off when the LIGHTS button is pressed. There is no automatic control logic.

Countdown Timer—the lights relay will turn on when the LIGHTS button is pressed. The lights relay will turn off automatically after a programmed time (see Timers Menu in Operation Manual). The LIGHTS button can also be used to turn the output off.

Low Speed of a 2-speed Filter Pump – the Aqua Logic will turn on the lights relay whenever the low speed operation of the filter pump is required. It is very important that the “2-speed” filter pump option be selected under the “Filter Config.” Menu for proper operation.

Timeclock – the lights relay will turn-on and turn-off at the times set for the lights timeclock in the Settings Menu (see Settings Menu in Operation Manual). The LIGHTS button can also be used to turn the output on and off.

Solar – the lights relay can operate a solar booster pump which will turn on when the filter pump is running and solar heat is available and the water is less than the desired temperature setting. It is important to note that “Solar” must be enabled in the “Solar Config.” menu for proper operation to occur.

Low Speed of a 2-Speed Spa Filter Pump – the Aqua Logic will turn on the lights relay whenever the low speed operation of the Dual Equipment Spa filter pump is required. “Pool and Spa-Dual” (located in Pool/Spa Setup menu) and “2-Speed” (located in Spa Filter Config. menu) must be selected for proper operation.

Group – the lights relay operates when the Group function is initiated and shuts off when the Group function is terminated. See Lights Group section for operation information for the Group function.

Super Chlorinate – The Super Chlorinate function can be assigned to any Aux, Lights or Valve button. This allows the user to simply hit a button to start a Super Chlorinate cycle, rather than using the Settings Menu. Note that only one button can be assigned to this function.

Lights Relay

This feature allows the user to select either “Standard” (default) or “Dimmer” type relay for the Lights output. The optional AQL-DIM dimmer kit must be installed if “Dimmer” is desired. When “Dimmer” is selected, and the Lights output is manually turned on, the “+” and “-” buttons adjust the level from 20% to 100% (default). The level is saved for the next time the lights are turned from off to on.

Lights Interlock

If enabled, this feature will override the function (Manual On/Off, Countdown Timer, Timeclock) selected above and turn the lights relay off when: filter pump is off, first 3 minutes of filter pump operation (allows the pump to prime and get water flowing), when the pool/spa suction return valves are in any position other than “pool only”, or for the first 3 minutes after solar turns on (allows air in the solar panels to be purged). Interlock is not available for solar, low speed filter pump, dimmer, or group functions.

Lights Group

The Lights Group function allows the user to perform multiple tasks with a single push of the “Lights” button. When setting up a Group function, refer to page 22 for specific programming information. There are two Group menus; the first menu determines how the group command will be initiated (Manual On/Off, Countdown Timer, or Timeclock) and the second menu selects the desired functions and their respective control parameters.

When activating Group functions, be aware that the most recent Group function that is initiated will override any previous Group function.

Lights Freeze Protection

This function helps protect equipment that is wired to the lights relay against freeze damage. If Freeze Protection is enabled and the AIR temperature sensor falls below the selected freeze temperature threshold, the Aqua Logic will energize the lights relay. **IMPORTANT:** this only enables operation of the lights relay during freeze--see the “Filter Pump Config.” menu to enable freeze protection for the main circulation system. Freeze Protection is not available for low speed filter pump, dimmer, or group functions.

if “Pool & Spa Dual” is selected

| | |
|--|---|
| Spa Filter Config. + to view/change | + Push to access Spa Filter options < > Move to previous/next configuration menu item |
| Spa Filter Pump 1 Speed | + - Toggle between 1 speed (default) and 2 speed options < > Move to next menu item |
| Freeze Protect Enabled | + - Toggle between Enabled (default) and Disabled Freeze Protection < > Move to previous/next configuration menu |































Spa Filter Pump

For 2-speed pumps: When a 2-speed pump is configured, one of the AUX relays must also be configured to control the low speed motor winding on the pump (see page 15 for wiring and page 31 for AUX configuration). See the Operation manual for specific information regarding the control logic for 2-speed pump operation.

Freeze Protection

Freeze protection is used to protect the spa and plumbed equipment against freeze damage. If freeze protection is enabled and the AIR temperature sensor falls below the freeze threshold (selectable in Filter Pump Configuration Menu - page 25), the Aqua Logic will turn on the spa filter pump to circulate the water.

NOTE: The configuration parameters for all Aux outputs are same as shown below for Aux1. PS-4: Aux1 and Aux2. PS-8: Aux1 through Aux6. PS-16: Aux1 through Aux14. Also note that for the PS-16, Valves 7, 8, 9 and 10 are turned On/Off with the control function selected for Aux7, 8, 9, and 10, respectively.

| | |
|---|--|
| Aux1 Config. + to view/change |  Push to access Aux options   Move to previous/next configuration menu |
| Aux1 Name Cleaner |   Rotates between all available names   Move to next menu item |
| Aux1 Function Manual On/Off |   Rotates between Manual On/Off (default), Countdown Timer, Low Speed-Filter, Timeclock, Solar, Low speed-Spa Filter, Group & Super Chlorinate   Move to next menu item |
| <i>for manual on/off, countdown timer and timeclock functions</i> | |
| Aux1 Relay Standard |   Toggle between Standard (default) and Dimmer   Move to next menu item or previous/next configuration menu |
| <i>for all functions except solar, dimmer relay, low speed (filter pump), and group</i> | |
| Aux1 Interlock Disable |   Toggle between Enabled and Disabled (default) Aux1 Interlock   Move to next menu item |
| <i>for group function only</i> | |
| Aux1 Group Timer: None(Manual) |   Rotates between Manual On/Off (default), Countdown Timer and Timeclock   Move to next configuration menu item |
| <i>for group function only</i> | |
| Aux1 Group Filter: Unaffected |   Options available depend on the function that is selected   Move to previous/next menu item or next configuration menu |
| <i>for all functions except dimmer relay, low speed, and group</i> | |
| Aux1 Freeze Disable |   Toggle between Enabled (default) and Disabled Aux1 Freeze   Move to previous/next configuration menu |

 **WARNING: Do not use the Aqua Logic to control an automatic pool cover. Swimmers may become entrapped underneath the cover.**

NOTE: If “Pool and Spa-Dual” is selected, Aux1 is dedicated to use as the spa filter. Its Name is set to Spa Filter, the Function is set to Timeclock and Interlock is set to Disabled. These can’t be changed.

Aux1 Name

The Aqua Logic allows you to assign any one of a number of names (e.g. “Cleaner Pump, Waterfall, Gazebo Light, etc.) to each of the aux outputs control function. This will make the Aqua Logic much more user friendly to the homeowner when they want to turn various aux equipment on or off or program the timeclocks. A sheet of small name labels is included with the Aqua Logic main unit and each remote display/keypad so that the “Aux” pushbutton can be labeled the same as the name that you have assigned. At this time it is also a good idea to make sure that the relay in the control box is also labeled (hand written) with the same name as a help to technicians who may service this system at a later date.

Aux1 Function

Manual On/Off (default)—the aux relay will alternate between turning on and off when the aux button is pressed. There is no automatic control logic.

Countdown Timer – the aux relay will turn on when the AUX button is pressed and then will turn off automatically after a programmed time (see Timers Menu in the Operations Manual). The AUX button can also be used to turn the output off.

Low Speed of a 2-speed Filter Pump – the Aqua Logic will operate the aux relay whenever the low speed operation of the filter pump is required. It is very important that the “2-speed” filter pump option be selected under the “Filter Config.” Menu for proper operation.

Timeclock – the aux relay will turn-on and turn-off at the times set for the aux timeclock in the Timers Menu (see Operations Manual). The AUX button can also be used to turn the output on and off.

Solar – the aux relay operates a solar booster pump which will turn on when the filter pump is running and solar heat is available and the water is less than the desired temperature setting. It is important to note that “Solar” must be enabled in the “Solar Config.” menu for proper operation to occur.

Low Speed of a 2-Speed Spa Filter Pump – the Aqua Logic will turn on the aux relay whenever the low speed operation of the Dual Equipment Spa filter pump is required. “Pool and Spa-Dual” (located in Pool/Spa Setup menu) and “2-Speed” (located in Spa Filter Config. menu) must be selected for proper operation.

Group – the aux relay operates when the Group function is initiated and shuts off when the Group function is terminated. See Aux1 Group section for operation information for the Group function.

Super Chlorinate – The Super Chlorinate function can be assigned to any Aux, Lights or Valve button. This allows the user to simply hit a button to start a Super Chlorinate cycle, rather than using the Settings Menu. Note that only one button can be assigned to this function.

Aux1 Relay

This feature allows the user to select either “Standard” (default) or “Dimmer” type relay for the Aux1 output. The optional AQL-DIM dimmer kit must be installed if “Dimmer” is desired. When “Dimmer” is selected, and the Aux1 output is manually turned on, the “+” and “-” buttons adjust the level from 20% to 100% (default). The level is saved for the next time the aux1 output is turned from off to on.

Aux1 Interlock

If “Enabled”, this feature will override the function (Manual On/Off, Countdown Timer, Timeclock), selected above and turn the aux1 off when: filter pump is off, first 3 minutes of filter pump operation (allows the pump to prime and get water flowing), when the pool/spa suction return valves are in any position other than “pool only”, or for the first 3 minutes after solar turns on (allows air in the solar panels to be purged). Interlock is not available for solar, low speed filter pump, dimmer, or group functions.

Aux1 Group

The Aux1 Group function allows the user to perform multiple tasks with a single push of the “Aux1” button. When setting up a Group function, refer to page 22 for specific programming information. There are two Group menus; the first menu determines how the group command will be initiated (Manual On/Off, Countdown Timer, or Timeclock) and the second menu selects the desired functions and their respective control parameters.

When activating Group functions, be aware that the most recent Group function that is initiated will override any previous Group function.

Aux1 Freeze Protection

This function protects the pool, plumbing, and equipment against freeze damage. If Freeze Protection is enabled and the AIR temperature sensor falls below the selected freeze protection temperature, the Aqua Logic will turn on the aux relay to circulate the water. **IMPORTANT:** this only enables operation of the AUX output during freeze--see the “Filter Pump Config.” menu to enable freeze protection for the main circulation system. Freeze Protection is not available for low speed filter pump, dimmer, or group functions.

AQL-PS-8-V models only: Aux3 - Aux7 only
AQL-PS-16-V models only: Aux7 - Aux14 only

| | |
|-----------------------------------|---|
| Aux7 Config. + to view/change | + Push to access Virtual Aux options < > Move to previous/next configuration menu |
| Aux7 Name Cleaner | + - Rotates between all available names < > Move to next menu item |
| Aux7 Function Group | + - Rotates between Super Chlorinate, Group and Manual On/Off < > Move to next menu item |
| Aux7 Group Timer: None(Manual) | + - Rotates between Manual On/Off (default), Countdown Timer and Timeclock < > Move to next configuration menu item |
| Aux7 Group Filter: Unaffected | + - Options available depend on the function that is selected < > Move to previous/next menu item or next configuration menu |

For more information on the Group function, refer to page 22 in the Installation Manual. If neither Super Chlorinate or a Group can be assigned to a Virtual Aux button, the following will be displayed:

No Virtual
Functions Available

NOTE: The configuration for Valve3 and Valve4 are identical. However, if Heater2 was enabled, then the Valve4 configuration will not appear (a single relay is used to implement either the Heater2 function or the Valve4 function - it can not do both). For PS-16, see aux logic on page 31 for control of Valves 7, 8, 9 and 10.

| | |
|---|---|
| Valve3 Config. + to view/change | + Push to access Valve3 options < > Move to previous/next configuration menu |
| Valve3 Name Waterfall | + - Rotates between all available names < > Move to next menu item |
| Valve3 Function Solar | + - Rotates between Manual On/Off (default), Countdown Timer, Timeclock, Solar, In-floor Cleaner, Group, and Super Chlorinate < > Move to next menu item |
| <i>for all functions except solar and group</i> | |
| Valve3 Interlock Disabled | + - Toggle between Enabled and Disabled (default) Valve3 Interlock < > Move to next menu item |
| <i>for group function only</i> | |
| Valve3 Group Timer: None(Manual) | + - Rotates between Manual On/Off (default), Countdown Timer and Timeclock < > Move to next menu item |
| <i>for group function only</i> | |
| Valve3 Group Filter: Unaffected | + - Options available depend on the function that is selected < > Move to previous/next menu item or next configuration menu |
| <i>for all functions except group</i> | |
| Valve3 Freeze Disabled | + - Toggle between Enabled and Disabled (default) Valve3 Freeze < > Move to previous/next configuration menu |

Valve3 Name

The Aqua Logic allows you to assign any one of a number of names (e.g. “Cleaner Valve, Waterfall valve, Solar Valve, etc.) to each of the valve output control function. This will make the Aqua Logic much more user friendly to the homeowner when they want to turn various valves on or off or program the timeclocks. A sheet of small name labels is included with the Aqua Logic main unit and each remote display/keypad so that the “Valve3” (and “Valve4”) pushbutton can be labeled the same as the name that you have assigned.

Valve3 Function

Manual On/Off (default) – the valve3 relay will alternate between turning on and off when the VALVE3 button is pressed. There is no automatic control logic. The VALVE3 button can also be used to turn the valve output on or off.

Countdown Timer – the valve3 relay will turn on when the VALVE3 button is pressed and then will turn off automatically after a programmed time (see Timers Menu in the Operations Manual). The VALVE3 button can also be used to turn the output off.

Timeclock – the valve turns on/off at the times set for the valve3 timeclock in the Timers Menu (see Operations Manual). The valve3 button can also be used to turn the valve output on or off.

Solar – the valve operates when the filter pump is running and solar heat is available and the water is less than the desired temperature setting. Solar heating must be enabled in the “Solar Config. menu for proper operation to occur.

In-Floor Cleaner – the valve switches the water returning to the pool between the in-floor cleaner and the normal return jets which facilitate efficient surface skimming. The valve will operate the in-floor cleaner for the first half of each clock hour and then switch to the jets/skimming for the last half of the hour.

Group – the valve operates when the Group function is initiated and shuts off when the Group function is terminated. See valve3 Group section for operation information for the Group function.

Super Chlorinate – The Super Chlorinate function can be assigned to any Aux, Lights or Valve button. This allows the user to simply hit a button to start a Super Chlorinate cycle, rather than using the Settings Menu. Note that only one button can be assigned to this function.

Valve3 Interlock

If “Enabled”, this feature will override the function (timeclock, manual on/off, countdown timer or in-floor cleaner) selected above and turn the valve off whenever the filter pump is off or the pool/spa suction/return valves are set to “spa only” or “spillover” operation. Interlock is not available with solar or group.

Valve3 Group









The valve3 Group function allows the user to perform multiple tasks with a single push of the VALVE3 button. When setting up a Group function, refer to page 22 for specific programming information. There are two Group menus; the first menu determines how the group command will be initiated (Manual On/Off, Countdown Timer, or Timeclock) and the second menu selects the desired functions and their respective control parameters.

When activating Group functions, be aware that the most recent Group function that is initiated will override any previous Group function.

Valve3 Freeze Protection

This function protects the pool and plumbed equipment against freeze damage. If Freeze Protection is enabled and the AIR temperature falls sensor falls below the selected freeze protection temperature, the Aqua Logic will turn on the valve to allow circulation of the water. IMPORTANT: this only enables operation of the valve3 output during freeze--see the “Filter Pump Config.” menu to enable freeze protection for the main circulation system. Freeze protection is not available for group functions.

if AQL-SS-6B is connected

| | |
|------------------------------------|--|
| 6B Spa Config. + to view/change |  Push to access the 6 Button Spa Side Remote options   Move to previous/next configuration menu |
| Select 6B Spa A |  Rotates between all available remotes   Move to next menu item |
| 6B A, Button 1 Pool/Spa |  Rotates between System Off, Pool/Spa, Filter, Lights, Heater1, Valve3, Valve4, and all available Aux outputs   Move to previous/next menu item or next configuration menu |













Select 6B Spa

This menu only appears if more than one AQL-SS-6B is detected at power up. Select which of the available remote controls (A, B or C) is to be configured.

6B A, Button 1

This menu allows the user to map each button of the AQL-SS-6B to one of the standard Aqua Logic functions. The default selections are: Button 1 - Pool/Spa, Button 2 - Filter, Button 3 - Lights, Button 4 - Heater1, Button 5 - Aux1 and Button 6 - Aux2.

if AQL-SS-D is connected

| | |
|---|---|
| Digital Spa Config. + to view/change |  Push to access the Digital Spa Side Remote options   Move to previous/next configuration menu |
| Select Digital Spa A |  Rotates between all available remotes   Move to next menu item |
| Digital A, Button 1 Pool/Spa |  Rotates between System Off, Pool/Spa, Filter, Lights, Heater1, Valve3, Valve4, and all available Aux outputs   Move to previous/next menu item |
| Digital A, Setpoint Heater1 |  Rotates between heaters that are enabled   Move to previous menu item or next configuration menu |

Select Digital Spa



This menu only appears if more than one AQL-SS-D is detected at power up. Select which of the available remote controls (A, B or C) is to be configured.

Digital A, Button 1

This menu allows the user to map each button of the AQL-SS-D to one of the standard Aqua Logic functions. The default selections are: Button 1 - Pool/Spa, Button 2 - Filter, Button 3 - Lights, Button 4 - Heater1, Button 5 - Valve3, Button 6 - Valve4, Button 7 - Aux1 and Button 8 - Aux2.

Digital A, Setpoint

If more than one heater is installed, select the spa heater you wish to control. If no heaters are installed, "Heaters Disabled" will be displayed.

| | |
|-------------------------|--|
| Remote Menus Enabled |  Toggle between Enabled (default) and Disabled Remote Menus   Move to previous/next configuration menu |
|-------------------------|--|

This feature will prevent unauthorized access to the Settings, Timers, and Configuration menus from any of the Aqua Logic's remote display/keypads. When disabled, the remote display/keypads will only show the default menu and allow on/off control via the pushbuttons. Note that the function of the Aqua Logic's built-in display/keypad is unchanged by this selection. Once disabled, the only way to enable "Remote Menus" is to use the local display/keypad.

| | |
|---|--|
| All Timeclocks 7-day | Toggle between 7-day (default) and Weekend/Weekday time options Move to previous/next configuration menu |
| <p>This selection affects ALL of the timeclock logic in the Aqua Logic. If “7-day” is selected, each timeclock will have one set of turn-on/turn-off settings that operate every day of the week. If “Weekend/Weekdays” option is selected then the user can enter one set of turn-on/turn-off times for the weekend (fixed as Saturday/Sunday) and another set of turn-on/turn-off times for weekdays (Monday through Friday).</p> | |
| Time Format 12 hour AM/PM | Toggle between 12 hour AM/PM (default) and 24 hour time format options Move to previous/next configuration menu |
| Units °F and PPM | Toggle between °F and PPM (default) and °C and g/L (Metric) options Move to previous/next configuration menu |

| | |
|-------------------------------------|--|
| Reset Config. to Default Press + | Initiate reset of all configuration parameters Move to previous/next configuration menu (config. not reset) |
| Are you sure? + to proceed | Reset all configuration parameters Move to previous/next menu (config. not reset) |
| Config. reset Confirmed | Move to previous/next configuration menu |

Use this function to erase all previous system configuration settings and reset all configuration parameters back to the factory default values. This function is NOT reversible--be careful.

6. System Startup and Checkout

Before Startup

Before starting the Aqua Logic for the first time, be sure that the following items have been completed:

1. Pool/spa chemicals are within the recommended levels according to the chart on page 3.
2. Pool/spa salt level is between 2700 – 3400 PPM.
3. Properly rated circuit breakers are installed in the Aqua Logic subpanel.
4. All wiring is performed according to NEC and local codes.
5. The Aqua Logic is properly grounded and bonded.
6. The Aqua Logic is properly configured to control all desired functions.

Program Automatic Operation

Refer to the programming flow chart on the back cover of this manual for a listing of the available menus and the items included in each menu.

Settings Menu

Heater(s) and/or solar thermostat settings
 Chlorinator settings
 Day and Time

Timers Menu

Timeclock and/or Countdown timer settings

Heater Checkout

Follow these instructions to verify that the Aqua Logic is properly controlling the heater.

1. Check that the Aqua Logic is calling for the heater to turn on as indicated by the “Heater” LED being illuminated. If the “Heater” LED is illuminated, go directly to step 2; if not, then check the following:
 - The heater is enabled (Configuration Menu/Heater Config.).
 - The heater temperature setting is at least 2°F greater than the water temperature (Settings Menu / Pool Heater & Spa Heater).
 - The filter pump is running.
 - If the pool has solar heat and the solar priority feature is enabled (Configuration Menu/Solar Config) then solar must be off in order for the heater to fire. The easiest way to force solar off is to go to the Settings Menu / Pool Solar & Spa Solar and temporarily lower the temperature settings below the current water temperature.
2. Check that the heater is running. If not, then check:
 - Power is supplied to the heater.
 - The Aqua Logic control output is properly connected to the heater control (see ”Heater Control” wiring, page 15).
 - Some heaters also have internal switches or jumpers that have to be set correctly for remote control operation—refer to the heater manual and also “Heater Control” (page 15).
 - Heater is turned on (“Kill Switch” is in the “ON” position).
 - If a heater bypass valve is installed, check that water is flowing through the heater.
 - The heater temperature setting is set as high as possible (usually 104°F/40°C). Also note that some heat pumps actually have to be set to the lowest possible temperature.
3. Once the heater is running, you can verify the “heater cooldown” feature (optional - see Configuration Menu/Heater Config.) is operating properly:
 - Press the “Filter” button once (for 2 speed pumps, this may require 2 pushes of the “Filter” button).
 - The heater should turn off (“Heater” LED off) and the “Filter” LED will flash to indicate heater cooldown is active.
 - The display will periodically indicate that the filter pump is on for heater cooldown and show the minutes remaining.
 - The pump will automatically turn off at the end of the 5 minute heater cooldown period.

For more detailed instructions on control and operation of the Aqua Logic system, refer to the Operation Manual.

Service Mode

Service mode disables all automatic control operation and is intended to be used when servicing the pool system. To enter service mode, push the SERVICE button once on the main unit keypad. This will initially turn all outputs off and then allow you to turn outputs on/off manually at the main display (only). In service mode, the buttons on the optional remote display/keypad and the optional spa side remote will turn outputs off, but will not turn any output on. Heater control outputs and solar control outputs are prevented from turning on if the water temperature exceeds 104°F (40°C).

Pushing the SERVICE button again will enter a timed service mode. Service operation as described above will continue for 3 hours, then automatically return to normal operation.

Push the SERVICE button once more to exit out of Service mode.

The following statement is applicable if any of the wireless accessories are connected to the Aqua Logic system.

FCC Statement

(Compliance Statement, Part 15.19): This device complies with Part 15 of the FCC Rules. Operation is subject to the following two conditions: (1) This device may not cause harmful interference, and (2) this device must accept any interference received, including interference that may cause undesired operation.

WARNING (Part 15.21): Changes or modifications not expressly approved by the party responsible for compliance could void the user's authority to operate this equipment.

Industry Canada Statement

The term "IC" before the certification/registration number only signifies that the Industry Canada technical specifications were met.

Interference

This equipment has been tested and found to comply with the limits for a Class B digital device, pursuant to Part 15 of the FCC rules. These limits are designed to provide reasonable protection against harmful interference in a residential installation. This equipment generates, uses, and can radiate radio frequency energy and, if not installed and used in accordance with the instructions, may cause harmful interference to radio communications. However, there is no guarantee that interference will not occur in a particular installation. If this equipment does cause harmful interference to radio or television reception, which can be determined by turning the equipment off and on, then the user is encouraged to try to correct the interference by one or more of the following measures:

- Reorient or relocate the receiving antenna.
- Increase the separation between the equipment and the receiver.
- Connect the equipment into a power source on different circuit than the receiver.
- Consult the dealer or an experienced radio/TV technician for help.

LIMITED WARRANTY Goldline warrants its Aqua Rite, Aqua Rite Pro, Aqua Trol, Aqua Logic and Pro Logic products (products with Goldline part numbers starting with AQ-RITE-, AQ-RT-PRO, AQ-TROL-, AQ-LOGIC-, AQL-P-, AQL-PS-, AQL-CL-, PL-P-, PL-PS-, and HPC-2) to be free from defects in material or workmanship, under normal use and service:

For **three years** from the date of the initial system installation on private, residential swimming pools within the USA or Canada and **one year** from the date of initial system installation on commercial installations, installations outside of the USA or Canada and for any replacement parts or accessory products, provided they are installed in accordance with the Goldline installation instructions and specifications provided with the product. If written proof of the date of the initial system installation is not provided to Goldline, the manufacturing datecode on the Aqua Rite, Aqua Rite Pro, Aqua Trol, Aqua Logic and Pro Logic electronics unit will be the sole determinant of the date of the initial system installation.

For residential installations in USA or Canada: If a product is defective in workmanship or materials and is removed and returned freight prepaid within three (3) years after the date of the initial system installation, Goldline will, at its option, either repair or replace the defective product and return it freight prepaid.

For commercial installations, installations outside the USA and Canada, and accessory products and replacement parts: If a product is defective in workmanship or materials and is removed and returned freight prepaid within one (1) year after the date of the initial system installation, Goldline will, at its option, either repair or replace the defective product and return it freight prepaid.

Contact any Goldline dealer or contact Goldline at 61 Whitecap Drive, North Kingstown, RI 02852 for warranty service. The costs incurred in removal and/or reinstallation of the product are NOT covered under this warranty. Some states do not allow limitations on how long an implied warranty lasts, so the above limitation may not apply to you.

WARRANTY EXCLUSIONS:

1. Material supplied or workmanship performed by others in process of installation.
2. Damage resulting from improper installation including installation on pools larger than the product rating.
3. Problems resulting from failure to operate the product(s) in accordance with the recommended instructions contained in product's owners manual(s).
4. Problems resulting from failure to maintain pool water chemistry in accordance with the recommendations in the owners manual(s).
5. Problems resulting from tampering, accident, abuse, negligence, unauthorized repairs or alternations, fire, flood, lightning, freezing, external water, degradation of natural stone used in or immediately adjacent to a pool or spa, war or acts of God.

DISCLAIMER. THE EXPRESS LIMITED WARRANTY ABOVE CONSTITUTES THE ENTIRE WARRANTY OF GOLDLINE WITH RESPECT TO ITS POOL AUTOMATION AND CHLORINATION PRODUCTS AND IS IN LIEU OF ALL OTHER WARRANTIES, EXPRESSED OR IMPLIED, INCLUDING WARRANTIES OF MERCHANTABILITY OR FITNESS FOR A PARTICULAR PURPOSE. THIS WARRANTY GIVES YOU SPECIFIC LEGAL RIGHTS, AND YOU MAY ALSO HAVE OTHER RIGHTS WHICH VARY FROM STATE TO STATE. IN NO EVENT SHALL GOLDLINE BE RESPONSIBLE FOR ANY CONSEQUENTIAL, SPECIAL OR INCIDENTAL DAMAGES OF ANY NATURE WHATSOEVER, INCLUDING, BUT NOT LIMITED TO, PERSONAL INJURY, PROPERTY DAMAGE, DAMAGE TO OR LOSS OF EQUIPMENT, LOST PROFITS OR REVENUE, COSTS OF RENTING REPLACEMENTS, AND OTHER ADDITIONAL EXPENSES, EVEN IF THE SELLER HAD BEEN ADVISED OF THE POSSIBILITY OF SUCH DAMAGES. SOME STATES DO NOT ALLOW THE EXCLUSION OF LIMITATION OF INCIDENTAL OR CONSEQUENTIAL DAMAGES, SO THE ABOVE LIMITATION OR EXCLUSION MAY NOT APPLY TO YOU.

NO WHOLESALE, AGENT, DEALER, CONTRACTOR OR OTHER PERSON IS AUTHORIZED TO GIVE ANY WARRANTY ON BEHALF OF GOLDLINE.

THIS WARRANTY IS VOID IF THE PRODUCT HAS BEEN ALTERED IN ANY WAY AFTER LEAVING THE FACTORY.

Aqua Logic Programming Flow Chart

