

Produced exclusively by



Established over 40 years ago, Blagdon are committed to producing a comprehensive range of high quality, easy to use, pond equipment. An ongoing programme of research and development ensures excellent performance and value for all their customers. This product excellence is demonstrated by Blagdon's award winning range of water gardening equipment. As a result Blagdon's reputation for quality is unrivalled amongst experienced pond gardeners and retailers alike.

Blagdon - The Pond Masters
The name you can rely on

www.aquagarden-range.co.uk
Interpet, Vincent lane
Dorking, Surrey, RH4 3YX
Leaflet Code: AG PUMPS 2-a

the choice of the water gardener
Aquagarden

GUIDE TO
Aquagarden
for Fountains, Filters
and Waterfalls
2500



GUIDE TO

Aquagarden pond for Fountains, Filters and Waterfalls 2500

Congratulations on buying an Aquagarden Pond pump fountains filters and waterfalls Fountain and Water Feature Pump. Aquagarden pumps are high quality pumps manufactured with advanced technology, to run pond fountains filters and waterfalls.

The powerful motors are easy to maintain having a single moving part impeller system featuring highly wear-resistant ceramic shaft design.

IMPORTANT

**Please attach proof of purchase to this manual
and file in a safe place.**

CONTENTS

Getting to know your Aquagarden pump	3
Parts descriptions / spares codes - with exploded diagram	4
Technical specifications	5
Pump performance / flow chart	5
Installation	6
Electrical installation	6
Installing pump in pond	7
Maintenance and cleaning	9
Cleaning	9
Step by step guides	9-10
Routine maintenance	9
Monthly maintenance	10
Annual maintenance	10
Winter storage	10
Troubleshooting	11
Troubleshooting and maximise performance	11
Faults - problem procedure	12
Returning faulty pumps	12
Consumer advice contact details	12
Guarantee	13

GETTING TO KNOW YOUR AQUAGARDEN PUMP

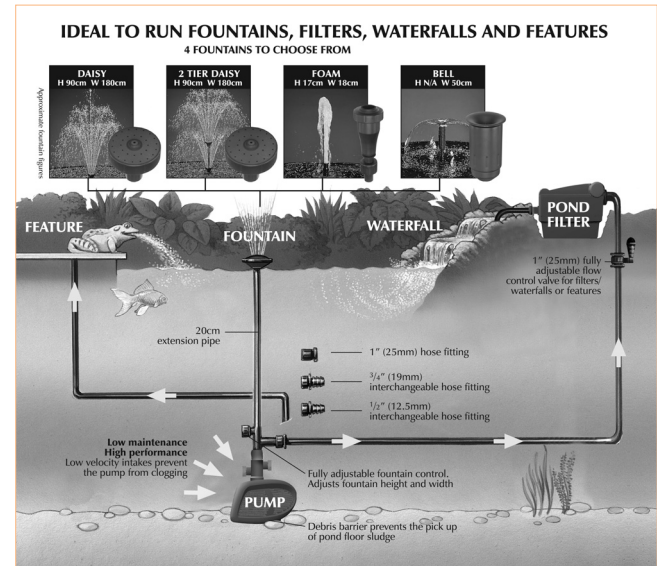

GETTING TO KNOW YOUR AQUAGARDEN PUMP

POND PUMP 2500

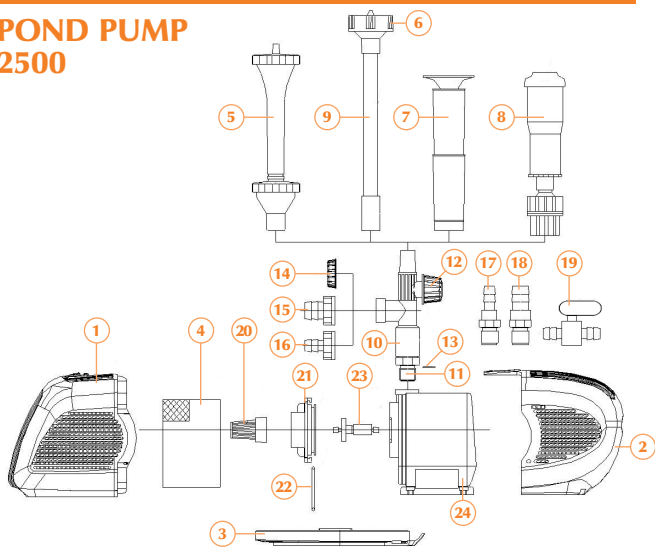

For spares for your Aquagarden product select compatible Blagdon spare part numbers

No.	Part Description	Blagdon Code	No.	Part Description	Blagdon Code	
1	Pre-filter cage front	1040495	13	T connector O ring	1040532	
2	Pre-filter cage back		14	Outlet cap		
3	Pre-filter cage insert base		15	3/4" hose tail		
4	Foam pre-filter	16	1/2" hose tail			
5	Double daisy jet	1040518	17	1/2" outlet hose tail		
6	Daisy jet		18	3/4" outlet hose tail		
7	Bell jet		19	1" flow control valve		1040563
8	Foam jet		20	Intake cage		1040549
9	20 cm extension	21	Impeller cover			
10	Fountain T piece	1040532	22	Impeller cover O ring		1040556
11	T connector		23	Impeller complete		
12	Fountain flow control		24	Motor	N/A	

4

Parts 1-3, 5-8, 10-18 and 20-22 are supplied as one package.

GETTING TO KNOW YOUR AQUAGARDEN PUMP

Pump performance / flow chart

POND PUMP	very small pond 2500
Lift	Flow rates lph
2.0 metres	240 lph
1.5 metres	800 lph
1.0 metres	1200 lph
0.5 metres	1640 lph
0.0 metres	2200 lph

Flow is given as optimum rate

Technical Specification & Performance

POND PUMP	very small pond 2500
Cable Fitted	10 metres
Voltage	230V
Hertz	50Hz
Watts	48
Safety Rating	IP68
Maximum Depth	2.2 metres
Maximum Lift	2.2 metres / 7'2"

5

INSTALLATION

Electrical installation



The power supply must meet the specifications on the product.

The pump is intended to be used with either a weather-proof cable connector or permanently connected to the fixed wiring in the main system other than by means of a plug and socket.

The cores in the supply cable are coloured in accordance with the following code: **Brown = Live, Blue = Neutral, Green/Yellow = Earth.**

The electric cable is permanently connected and sealed in the motor body. If the supply cable is damaged the pump must not be used.

Do not use the supply cable to lift the pump as this may cause damage.

IMPORTANT: Please note all electrical work on garden lighting and power installations must comply with part P of the building regulations. Failure to comply is a criminal offence. If the installation of this product is not carried out by a competent electrician who is registered under the Part P self-certification scheme then you must notify the local building control department before work begins. For further information and guidance on this matter and other electrical installations in your home that might be covered by the relevant legislation, contact your local authorities building control department.



WARNING - THIS PUMP MUST BE EARTHED

A Residual Current Device (RCD), also known as the Residual Current Circuit Breaker (RCCB), with a tripping current not exceeding 30mA must be installed in the supply circuit.

A means of disconnection from the supply having a contact separation of at least 3mm in all poles must be incorporated in the fixed wiring.

INSTALLATION

For permanent installations to the mains supply, it is necessary to conform to the regulations of the local electricity authority and this would include the use of a metal or plastic conduit to protect the cable.

Attention has been drawn to the fact that special rules may exist concerning the installation of your pond pump (i.e. local building regulations).

These pumps must not be used in swimming pools, or areas where people are in contact with the water.

Always disconnect the mains electricity supply whilst the equipment is being installed, repaired, maintained or handled. Consult a qualified electrician if in any doubt about wiring this product to the main supply.



Warning - The pond pump is provided with a thermal cut out that temporarily switches off the pump in case of overheating and the pump may automatically restart.

Never run the pump out of water as this may cause irreparable damage.

Locating your Aquagarden pump

The Aquagarden pump should be located on a firm and level base in the pond/water feature in a depth of at least 10cm, but no more than 2m.

It is advisable to keep the pump off the bottom of the pond to avoid silt entering the pump causing excessive wear and increasing pre-filter cleaning.

Fountain

Make sure there is ample cable from mains supply. Place pump in desired location. Add Fountain extension pipes so fountain head is above surface of the pond. Fountain height can now be adjusted, see 'Adjusting flow control' diagram below. See "Getting to know your Aquagarden" for parts and descriptions.

If using the Daisy or Double Daisy Jet, cleaning of the jets will be reduced by inserting the optional pre-filter foam included.

Tip: Ensure that any fountain, waterfall, filter or feature fitted does not empty water out of pond/water feature. In windy conditions it may be necessary to shut off or reduce the height of your fountain display to prevent water loss. Also see the explanatory diagram on the top face of your Aquagarden pump carton.

INSTALLATION

ADJUSTING FLOW CONTROL

Turn clockwise to increase, anti-clockwise to reduce flow.

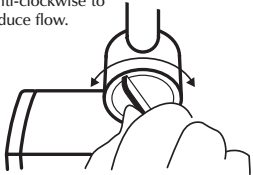

BELL FOUNTAIN

Adjust bell by moving head higher for small bell and lower for a wider bell shape.

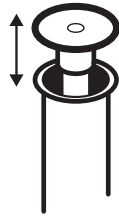

Tip: Ensure that any fountain or feature fitted does not empty water out of pond/water feature. The Bell Jet and Foam Jets do not need the foam pre-filter so require little maintenance when used with the pre-filter cage only.

Water Feature

Install as for Fountain. Depending on water feature to be supplied, your pond pump can be used with the 1/2" hose fitting or 3/4" outlet hose fitting which can be screwed directly into pump body. Hose clips should be used to secure hose.

Tip: The larger 1" hose will give maximum performance when fitted.

MAINTENANCE & CLEANING



Warning - Failure to carry out routine maintenance leaving the pump under reduced or no flow conditions for long periods (i.e. blocked pre-filter) will result in a shorter pump life and will invalidate the guarantee.

Aquagarden 2500 is a centrifugal pump with a magnetic impeller movement driven by a watertight synchronous motor. They require minimum cleaning, only periodic cleaning of the pre-filter and impeller is necessary.

Routine Maintenance

Carry out routine maintenance when pump flow is visibly reduced.

1. Switch off electricity.
2. Remove pump from pond (do not use the cable to lift the pump).
3. Remove the front of the pre-filter cage by depressing the button and pulling apart. Wash the cage thoroughly in fresh water. A blocked pre-filter will reduce pump flow. Follow steps 1 and 2.

STEP 1: POND PUMP 2500 (ROUTINE)

Firmly pull pre-filter cage from pump motor.

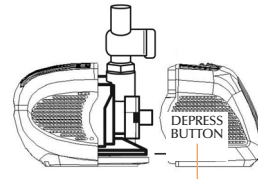

STEP 2: POND PUMP 2500 (ROUTINE)

Remove pre-filter foam (if fitted), and wash thoroughly in fresh water. The pre-filter is for use with Daisy Jets only. A blocked foam will reduce the pump flow rate.

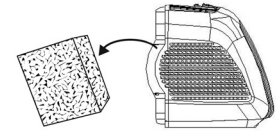

MAINTENANCE & CLEANING

Monthly Maintenance

Following as for Routine Maintenance (steps 1 and 2) and then steps 3, 4 and 5.

STEP 3: POND PUMP 2500 (MONTHLY)

Remove impeller cover by turning anti-clockwise to release lock. Then pull firmly away from pump motor and cage.

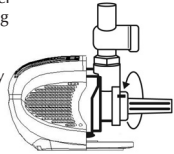

STEP 4: POND PUMP 2500 (MONTHLY)

Remove impeller from pump motor. Wash parts with fresh water carefully.



Annual Maintenance

Dismantle pump and examine all parts for wear or damage, replacing any parts that show obvious wear and/or damage. (See getting to know your pump for parts/description and replacement parts codes.) Particular care should be taken to examine the cable entry point and the cable; if there is any sign of damage the pump should be discarded.

Winter Storage

The pump can be run in the pond during the winter but care should be taken to ensure that it is fully immersed and cannot freeze solid. If the pump is not used during the winter, follow annual maintenance procedure and store frost-free in the house or garage until spring.

TROUBLESHOOTING

Problem

Low flow from pump

1. Follow routine cleaning procedure if no improvement.
2. Follow monthly cleaning procedure.
3. Ensure pipe work is not blocked, leaking or is laid so that it gets crushed or kinked.
4. Keep the height that water is to be pumped from the water surface (called Head) to a minimum. The higher the head the lower the flow rate and the more wear on the pump.
5. Use the largest diameter, smoothest bore pond hose over the shortest distance and keep hose fittings to a minimum. This removes frictional loss of flow and so increases pump flow rates.

Poor Fountain performance

- Reduced height.
- Jets blocked.

Use foam insert with Daisy Jets for lower maintenance.

No flow from pump

1. Check power supply is on.
2. Check fuse and wiring (SEE ELECTRICAL INSTALLATION).
3. Follow low flow procedure as above.

If none of the above works contact Interpet (Blagdon) Consumer Advice Department (See Faults problem procedure Page 12).

DAISY

To clean, remove head and rinse.

Use optional foam pre-filter with Daisy Jet heads.



IMPORTANT

FAULTS - PROBLEMS PROCEDURE

Before returning your Aquagarden pump to your dealer or contacting our Consumer Advice Department, please carry out the following steps. This will solve most problems quickly and easily.

1. Ensure electrical procedure has been followed fully. Check fuse and any cable connectors/switch boxes.
NOTE: If the pump has overheated the thermal overload will temporarily switch off the pump.
2. (a) Follow routine maintenance and check pump. (b) Follow monthly maintenance and check pump. (c) Follow troubleshooting guide.
(d) Follow annual maintenance guide.
3. Return pump to point of purchase for inspection and advice (You may need proof of purchase).

Consumer Advice contact details

Interpet (Blagdon) Consumer Advice Department

Vincent Lane, Dorking, Surrey RH4 3YX

Telephone: 0845 226 7437

(Monday to Friday 10am to 4pm except Bank Holidays - Times may vary)

Fax: 01306 876712

E-mail: customercare@interpet.co.uk

GUARANTEE

This product is guaranteed against defects in material and workmanship for 2 years from the date of purchase, under normal usage. **The guarantee DOES NOT APPLY in case of improper use**, negligence, lack of maintenance or accidental damage either to the pump or to the impeller or impeller shaft. If the pump fails due to a manufacturing fault within this period it will be either repaired or replaced free of charge. Liability is limited to replacement of the faulty product only, no other costs will be reimbursed.

This guarantee is not transferable and does not affect your statutory rights. This guarantee does not confer any rights other than those expressly set out above. Excludes the sponge pre-filter, which should be replaced every six months and the impeller, which may require replacing annually. If any parts need replacing, spares are available from your retailer.

Environment friendly disposal



You can help protect the environment.

Please remember to respect the local regulations: hand in the non-working electrical equipments to an appropriate waste disposal centre.