

# SERVICE MANUAL **SEGA**<sup>®</sup>



## CASH CUBE



**IMPORTANT**

Before using this product, read this SERVICE MANUAL carefully to understand the contents stated herein. After reading this manual, be sure to keep it available nearby the product or somewhere convenient in order to be able to refer to it whenever necessary.

Manufactured in the UK by



# CONTENTS

1.	BEFORE USING THIS PRODUCT .....	3
1.1.	INSPECTIONS IMMEDIATELY AFTER TRANSPORTING THE PRODUCT TO THE LOCATION .....	4
2.	INTRODUCTION TO THIS SERVICE MANUAL .....	6
3.	INSTALLATION AND MAINTENANCE INSTRUCTIONS .....	7
3.1.	HANDLING AND INSTALLATION PRECAUTIONS .....	7
3.2.	NAME OF PARTS .....	8
3.3.	ACCESSORIES .....	10
3.4.	ASSEMBLY INSTRUCTIONS .....	12
3.4.1.	INSTALLING THE POP PANEL (PUB-5006) .....	13
3.4.2.	SECURING IN PLACE (LEG ADJUSTER ADJUSTMENT) .....	14
3.4.3.	CONNECTION TO THE POWER SUPPLY .....	15
3.5.	MOVING THE MACHINE .....	16
3.6.	ELECTRICAL ASSEMBLY .....	17
3.6.1.	REMOVING THE ELECTRICAL ASSEMBLY .....	17
3.7.	CONTROL PANEL .....	18
3.7.1.	REPLACING THE CONTROL PANEL .....	18
3.8.	ACCELERATOR AND BRAKE .....	20
3.8.1.	REMOVING THE PEDALS .....	20
3.8.2.	ADJUSTING OR REPLACING THE VOLUME .....	23
3.8.3.	GREASING .....	24
3.9.	GAME BOARD .....	25
3.9.1.	TAKING OUT THE GAME BOARD .....	25
3.9.2.	COMPOSITION OF GAME BOARD .....	26
3.10.	MONITOR ADJUSTMENT .....	27
3.11.	TROUBLESHOOTING .....	29
3.12.	HOPPER ASSEMBLY .....	30
3.12.1.	HOPPER OPERATION .....	30
3.12.2.	HOPPER ASSEMBLY FAULT FINDING .....	30
3.13.	COIN MECHANISMS .....	32
3.13.1.	COIN MECHANISM OPERATION (FOR UK MACHINES) .....	32
3.13.2.	COIN MECHANISM FAULT FINDING .....	32
3.14.	FUSES .....	33
4.	REFILL MODE .....	34
4.1.	WHAT IS REFILL MODE? .....	34
4.2.	LANDLORD REFILL .....	34
4.3.	COLLECTOR REFILL .....	35
4.4.	DEALING WITH A HOPPER EMPTY ERROR .....	36
4.5.	METERS .....	37
5.	DATAPORT .....	38
5.1.	WHAT IS THE DATAPORT? .....	38
5.2.	SETTING PROCEDURE .....	38
5.3.	DATAPORT SETTING .....	39
5.4.	ERROR .....	40
6.	PERIODIC CHECK AND INSPECTION .....	41
6.1.	CLEANING THE CABINET SURFACES .....	41
7.	CONTENTS OF GAME .....	42
7.1.	HOW TO PLAY: POUND SETTING .....	42
8.	EXPLANATION OF TEST AND DATA DISPLAY .....	45
8.1.	SYSTEM TEST MODE .....	46
8.1.1.	RAM TEST .....	47
8.1.2.	JVS TEST .....	49
8.1.3.	INPUT TEST SCREEN .....	50
8.1.4.	SOUND TEST .....	50
8.1.5.	CRT TEST .....	51
8.1.6.	SYSTEM ASSIGNMENTS .....	52
8.1.7.	COIN ASSIGNMENTS .....	53
8.1.8.	BOOKKEEPING .....	54
8.1.9.	BACKUP DATA CLEAR .....	54
8.1.10.	CLOCK SETTING .....	55

8.1.11.	DIMM BOARD TEST .....	55
8.2.	GAME TEST DESCRIPTION MODE .....	56
8.2.1.	INPUT TEST SCREEN .....	56
8.2.2.	OUTPUT TEST SCREEN .....	57
8.2.3.	GAME SETTING.....	57
8.2.4.	HOPPER TEST MENU SCREEN.....	59
8.2.4.1.	INPUT TEST SCREEN .....	60
8.2.4.2.	OUTPUT TEST SCREEN .....	61
8.2.4.3.	COIN TEST SCREEN .....	62
8.2.4.4.	TROUBLE LOG SCREEN.....	64
8.2.4.5.	MEMORY SETTING .....	66
8.2.4.6.	DATAPORT SETTING .....	66
8.2.4.7.	COIN ASSIGNMENTS SETTING.....	67
8.2.5.	CREDIT SETTING .....	68
8.2.6.	VOLUME SETTING .....	70
8.2.7.	BOOKKEEPING SCREEN .....	70
8.2.7.1.	BOOKKEEPING FOR POUND, DOLLAR, EURO, OR ANY CASH SETTINGS.....	71
8.2.7.2.	BOOKKEEPING FOR TOKEN SETTING .....	75
8.2.8.	BACKUP DATA CLEAR SCREEN.....	81
9.	DESIGN RELATED PARTS.....	82
10.	APPENDIX A - ELECTRICAL SCHEMATIC.....	83
10.1.	WIRE COLOURS .....	83
10.2.	ELECTRICAL SCHEMATIC.....	83
10.3.	SCHEMATIC DRAWING 1 .....	84
10.4.	SCHEMATIC DRAWING 2 .....	85

# 1. BEFORE USING THIS PRODUCT

To ensure the safe usage, be sure to read the following before using the product. The following instructions are intended for the use of QUALIFIED SERVICE PERSONNEL ONLY.

If any activity is carried out on the product, this should be done only after carefully reading and sufficiently understanding the instructions.

Only qualified service personnel should carry out maintenance on the product.

Depending on the potential risk, terms such as "WARNING!" "CAUTION" and "IMPORTANT!" are used where an explanation is given that requires special attention. SEGA is not responsible for injury or damage caused by use in a manner contrary to the instructions given in this document.

In order to prevent accidents warning stickers and printed instructions are applied in the places where a potentially hazardous situation relating to the product could arise. Be sure to comply with these warnings.



Indicates that mishandling the product by disregarding this warning will cause a potentially hazardous situation that can result in death or serious injury.



Indicates that mishandling the product by disregarding this caution will cause a potentially hazardous situation that can result in personal injury and or material damage.



This is cautionary information that should be complied with when handling the product. Indicates that mishandling the product by disregarding this will cause a potentially hazardous situation that may not result in personal injury but could damage the product.

Be sure to turn off the power and disconnect from the mains supply before working on the machine.

Ensure that the correct fuses are fitted to the machine. Details of these are enclosed in the Service Manual.

Ensure that only qualified Service Engineers perform any maintenance work on the machine.

Specification changes, removal of equipment, conversion and/or additions not designated by SEGA are not permitted and will invalidate this product's CE conformity.

Warning labels or safety covers for personal protection etc, are component parts of the product. A potential hazard will be created if the machine is operated while any parts have been removed. Do not operate the product if any doors, lids or protective covers become damaged or lost. SEGA is not liable in any whatsoever for any injury and/or damage caused by specification changes not designated by SEGA.

Before installing the product, check for the Electrical Specification Sticker, SEGA products have a sticker on which the electrical specifications are detailed. Ensure that the product is compatible with the power supply voltage and frequency requirements of the location in which the machine is to be installed.

Install and operate the machine only in places where appropriate lighting is available, allowing warning stickers to be clearly read.

To ensure maximum safety for customers and operators, stickers and printed instructions describing potentially hazardous situations are applied to potentially hazardous locations. Ensure that the product's operating location has sufficient lighting to allow any warnings to be read. If any sticker or printed warning is removed or defaced, do not operate the machine until an identical item has replaced it.

Exercise great care when handling the monitor (applies only to product with monitor). Some of the monitor (TV) parts are subject to high-tension voltage. Even after turning the power off some components are liable to high-tension voltage. Only qualified service engineers should perform monitor repair and replacement.

In cases where commercially available monitors and printers are used, only the items relating to this product are contained in this manual. Some commercially available equipment will have functions and reactions not referred to in this manual. This manual should be read in conjunction with the specific manufacturer's manual for such equipment.

Descriptions contained herein may be subject to change without prior notification.

The contents described herein are fully prepared with due care. However, should any question arise or errors be found please contact **SEGA AMUSEMENTS EUROPE LTD.**

## 1.1. **INSPECTIONS IMMEDIATELY AFTER TRANSPORTING THE PRODUCT TO THE LOCATION**



- Only QUALIFIED SERVICE PERSONNEL should carry out inspection.

Normally, at the time of shipment, SEGA products are in a state to allowing usage immediately after transporting to the location. Nevertheless, an irregular situation may arise during transportation preventing this. Before turning on the power, check the following points to ensure that the product has been transported safely.

- Are there any dented parts or defects (cuts, etc.) on the external surfaces of the product?
- Are castors and leg adjusters present and undamaged?
- Do the power supply voltage and frequency requirements meet with the local supply?
- Are all wiring connectors correctly and securely connected? Unless connected in the correct direction, connector connections cannot be made successfully. Do not insert connectors forcibly.
- Are all IC's of each IC BD firmly inserted?
- Does the power cord have any cuts or dents?
- Do fuses meet the specified rating?
- Are such units such as monitors, control equipment, IC BD, etc. firmly secured?
- Are all earth wires connected?
- Are all accessories available?
- Can all doors and lids be opened with the accessory keys and/or tools?

**CONCERNING THE STICKER DISPLAY**

SEGA product has stickers describing the product manufacture number (Serial Number) and electrical specification. If you require service assistance you will require the Serial Number. Identical machines may have different parts fitted internally. Only by quoting the Serial Number will the correct parts be identified.

**CONCERNING WARNING STICKERS**

SEGA product has warning displays on stickers, labels or printed instructions adhered/attached to or incorporated in the places where hazardous situations can arise. The warning displays are intended for the accident prevention of customers and service personnel.



SPECIFICATIONS	
Installation Space (mm):	650 (W) 940 (D)
Height (mm):	1576
Height with Pop Panel (mm):	1916
Weight (kg):	100 Kg (approx.)
Rated Voltage (VAC):	220 - 240
Rated Current (A):	1

Note: Descriptions in this manual are subject to change without prior notice.

## **2. INTRODUCTION TO THIS SERVICE MANUAL**

SEGA ENTERPRISES LTD., supported by its experience in electronic high technology of VLSI's, microprocessors etc. and with a wealth of experience, have for more than 30 years been supplying various innovative and popular games to the world market. This Service Manual is intended to provide detailed descriptions together with all the necessary information covering the general operation of electronic assemblies, electro-mechanicals, servicing controls, spare parts, etc. as regards this new SEGA product. This manual is intended for those who have knowledge of electricity and technical expertise especially in IC's, CRT's, microprocessors etc. Carefully read this manual to acquire sufficient knowledge before working on the machine. Should there be any malfunction, non-technical personnel should under no circumstances touch the internal systems. Should such a situation arise contact the nearest branch listed below, or our head office.

### **SEGA AMUSEMENTS EUROPE LTD./ SEGA SERVICE CENTRE**

Suite 3a  
Oaks House  
12 - 22 West Street  
Epsom  
Surrey  
United Kingdom  
KT18 7RG

Telephone: +44 (0) 1372 731820

Fax: +44 (0) 1372 731849

### 3. INSTALLATION AND MAINTENANCE INSTRUCTIONS



- Only QUALIFIED SERVICE PERSONNEL should carry out installation and maintenance.

#### 3.1. HANDLING AND INSTALLATION PRECAUTIONS

When installing or inspecting the machine, be very careful of the following points and pay attention to ensure that the player can enjoy the game safely.

**The game must NOT be installed under the following conditions:**

- Outside, the game is designed for indoor use only.
- In areas directly exposed to sunlight, high humidity, dust, excessive heat or extreme cold.
- In locations that would present an obstacle in the case of an emergency i.e. near fire equipment or emergency exits.
- On unstable surfaces or surfaces subject to vibration.
- Where liquids, other than routine cleaning, may come into contact with the game.

**Important:**

- Only Qualified Service Personnel should install this machine.
- Be sure to switch the supply power OFF and remove the mains supply plug from the machine before any work is carried out on the machine.
- Do not attempt to repair the PCB's (Printed Circuit Boards) yourself. This will void the warranty. The PCB's contain static sensitive devices that could be damaged.
- Always return a faulty part to your distributor with adequate packaging and protection.
- When removing the plug from the mains always grasp the plug not the cable.
- Do not use a fuse that does not meet the specified rating.
- Make sure all connections are secure before applying power.



- Ensure that the mains lead is not damaged. If the mains lead is damaged in any way there could be a danger of electric shock or a fire hazard.
- Ensure that the power supply is fitted with circuit protection. Using the power supply without circuit protection is a fire hazard.



### 3.2. NAME OF PARTS



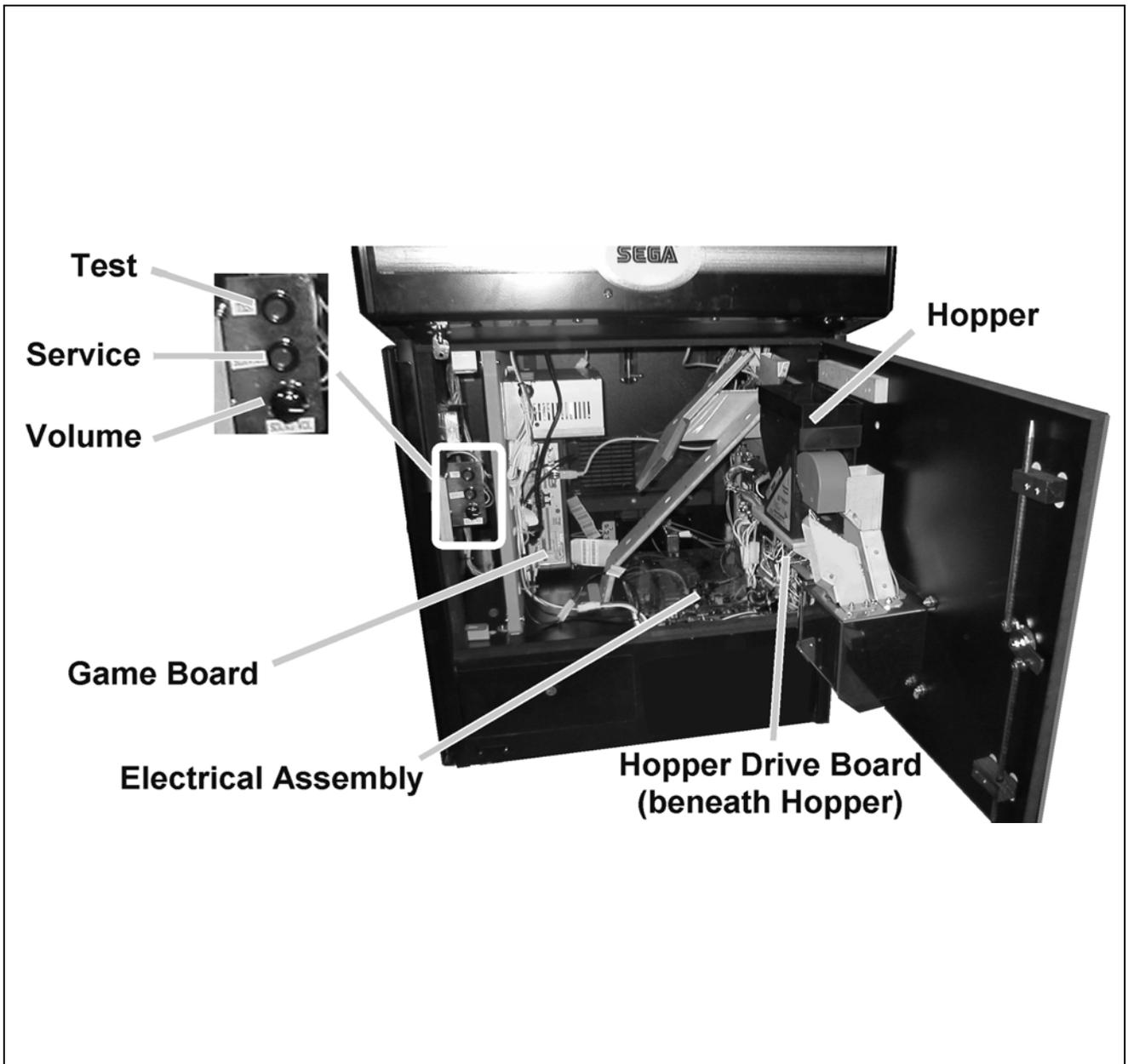

### 3.3. ACCESSORIES

The machine is supplied with an installation kit. Please ensure the following parts are supplied:



- The Installation Kit will be placed in the Cashbox. However larger items (e.g. the Pop Panel) will be placed in the recess beneath the Test and Service buttons inside the cabinet body.
- You must ensure that these items are removed before the machine is powered up.

No.	PART NUMBER	QTY	DESCRIPTION	COMPONENT REFERENCE
1	PUB-5006	1	POP CASHCUBE	
2	220-5753	1	VOL CONT B-5K OHM (TOCOS)	spare
3	SAECE-122	1	DECLARATION OF CONFORMITY CKP	
401	RND-0050	1	SERVICE MANUAL CKP PUB SWP	
402	OS1019	1	SELF SEAL BAG 9X12.3/4	
404	PK0061	0.025	BUBBLE WRAP LARGE 1.5M X 45M	
405	540-0006-01	1	WRENCH M4 TMP PRF	
406	540-0015-01	1	WRENCH M6 TMP PRF	

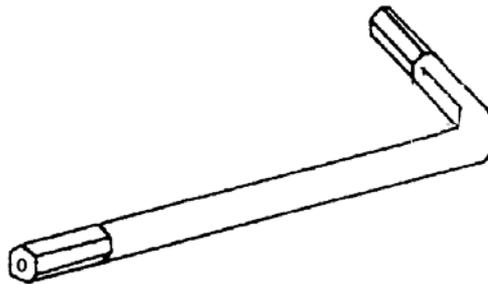

Items 405 & 406 - Tamperproof TORX wrench.



- When returning the GAME BOARD for repair or replacement, be sure to package the entire ASSY SHIELD CASE in the original card transit box - THERE ARE NO USER-SERVICEABLE PARTS INSIDE.
- Failure to return the GAME BOARD in this manner may invalidate the warranty.

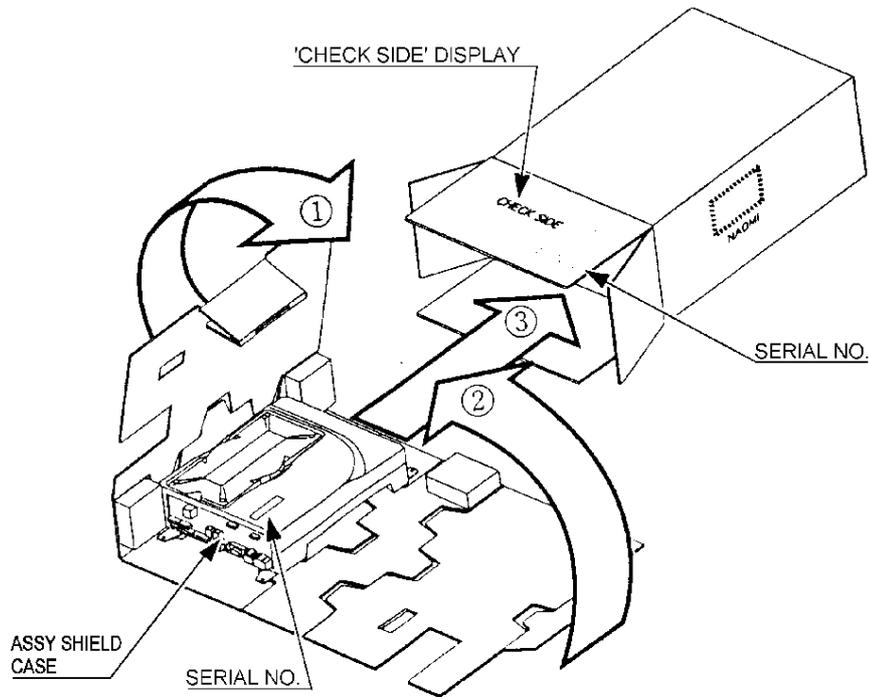

Wrap the ASSY SHIELD CASE with the packaging material and put it in the original transit box as shown. Putting it upside down or packing other than as shown can damage the GAME BOARD and parts.

### 3.4. ASSEMBLY INSTRUCTIONS



- Perform the assembly by following the procedure herein stated. Failure to comply with the instructions, for example, inserting the plug into an outlet at a stage not mentioned in this manual can cause an electric shock
- Assembling should be performed as per this manual. Since this is a complex machine, erroneous assembling can cause damage to the machine, or malfunction to occur.
- Do not attempt to complete this work alone, a minimum of 2 people are required.



- Only QUALIFIED SERVICE PERSONNEL should carry out assembly.

When carrying out the assembly work, follow the procedure in the following three item sequence:

- STEP 1**      INSTALLING THE POP PANEL
- STEP 2**      SECURING IN PLACE (LEG ADJUSTER ADJUSTMENT)
- STEP 3**      CONNECTION TO THE POWER SUPPLY

Note that the parts contained within the installation kit are required for the assembly work.

The following tools will be required when installing this machine:

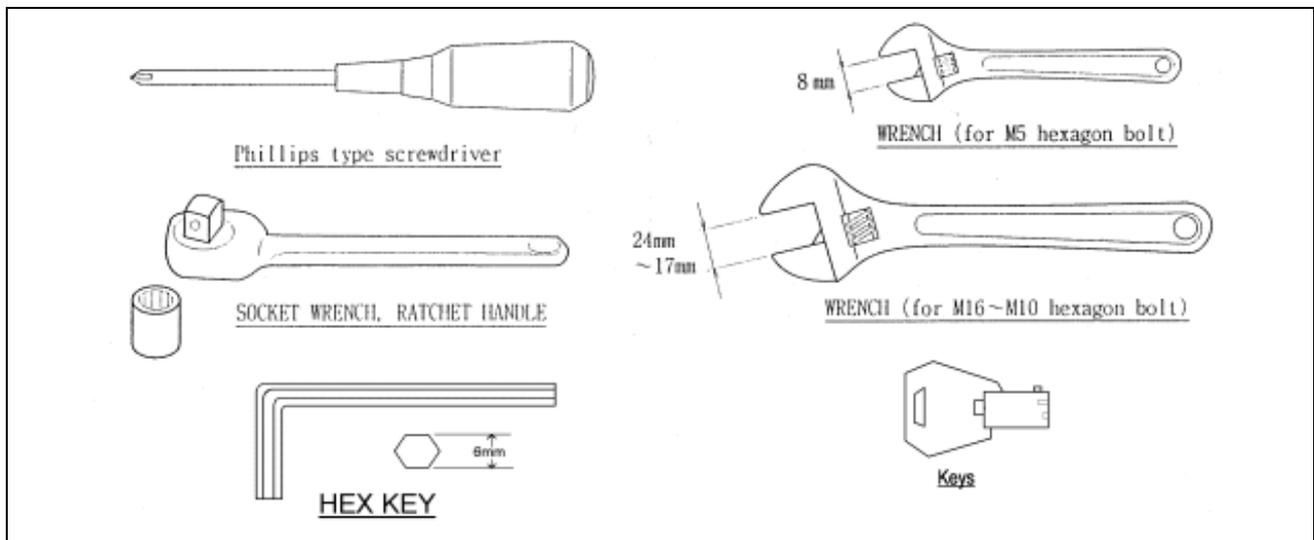

### 3.4.1. INSTALLING THE POP PANEL.(PUB-5006)



- QUALIFIED SERVICE PERSONNEL should only carry out this operation.

The Pop Panel picks up on the three top fixings of the Monitor Mask Moulding.

To fit:

- 1 Remove the three screws and washers on top of the Monitor Mask Moulding.
- 2 Offer up the Pop Panel and align over three fixing holes.
- 3 Re-fix the screws and washers.
- 4 Ensure the Monitor Mask Moulding is pushed back and seated properly to the cabinet.

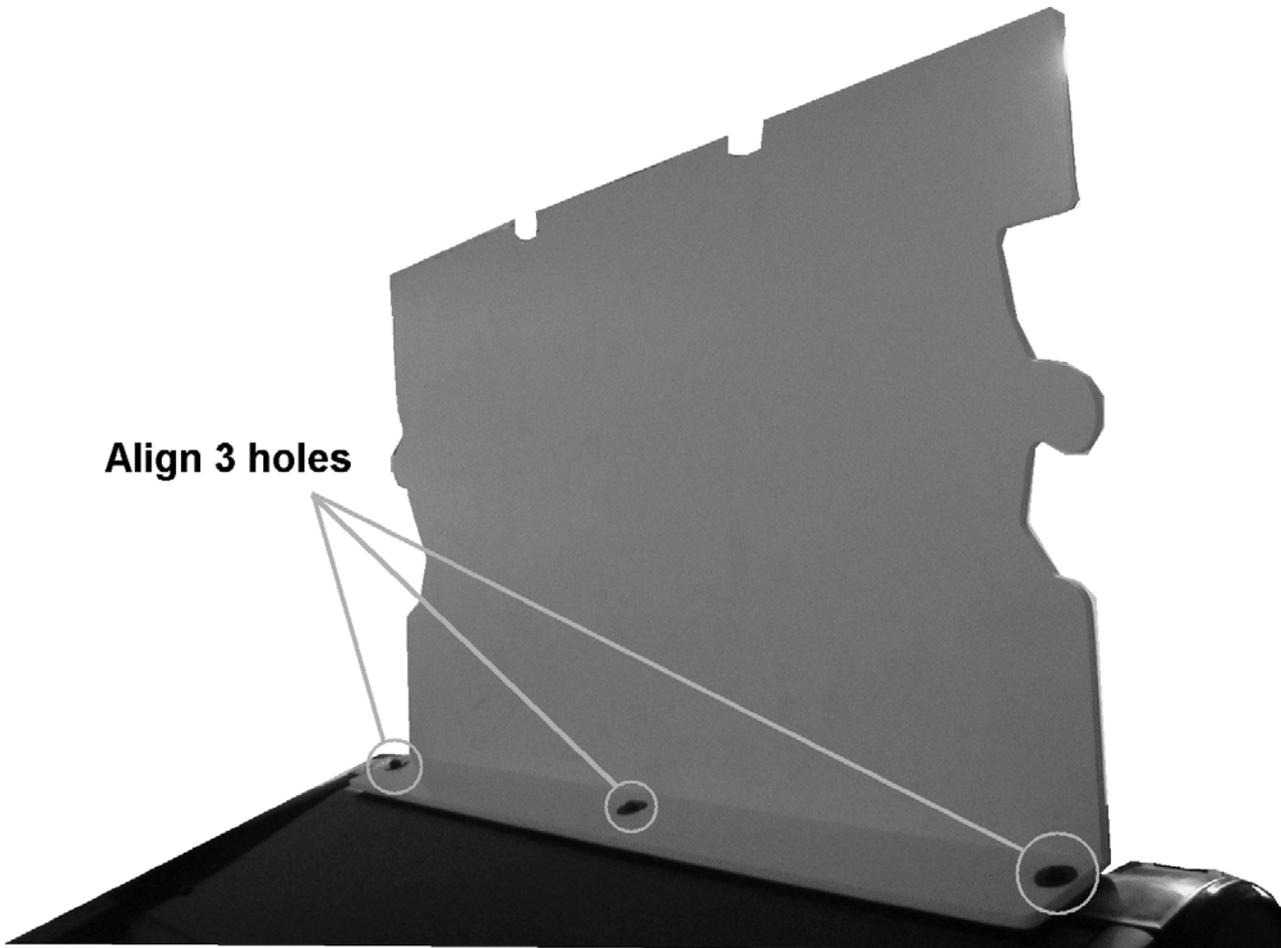

### 3.4.2. SECURING IN PLACE (LEG ADJUSTER ADJUSTMENT)



CAUTION



IMPORTANT

- *The nominal position for the leg adjusters is fully retracted. Only extend them if the machine is sited on an uneven surface.*

- Only QUALIFIED SERVICE PERSONNEL should carry out this operation.

This machine has two castors (at rear) and two leg adjusters (at front). Where the installation is flat and level, the adjuster should not need to be extended. Only extend the adjusters to prevent the machine from rocking.

To extend the leg adjusters:

1. Use a wrench to turn them until the machine is stable and level.

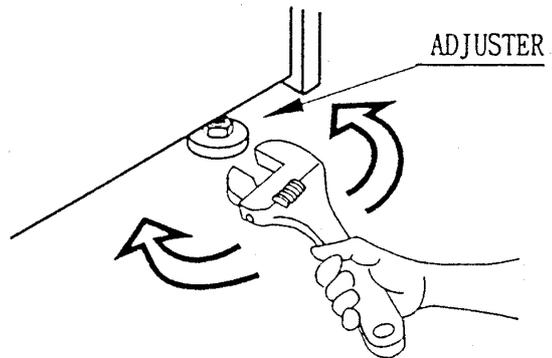

Ensure that all of the Adjusters are in contact with the floor.

**Ensure adequate ventilation is maintained by ensuring there is at least a 150mm gap between the back on the machine and any wall.**

### 3.4.3. CONNECTION TO THE POWER SUPPLY

To connect the machine to the power supply:

1. With the Mains Switch in the 'O' position, insert the IEC mains lead plug into the IEC socket.
2. Turn the machine on by switching the Mains Switch to the 'I' position.

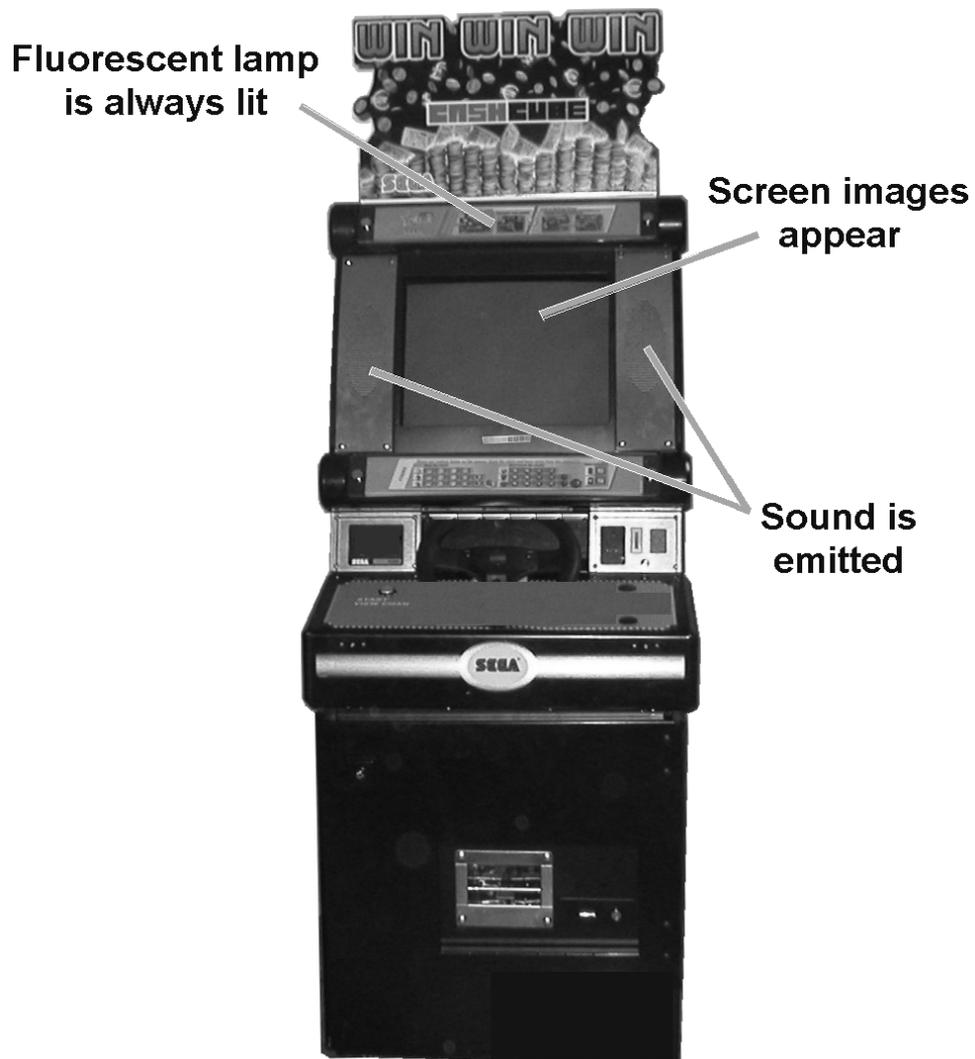
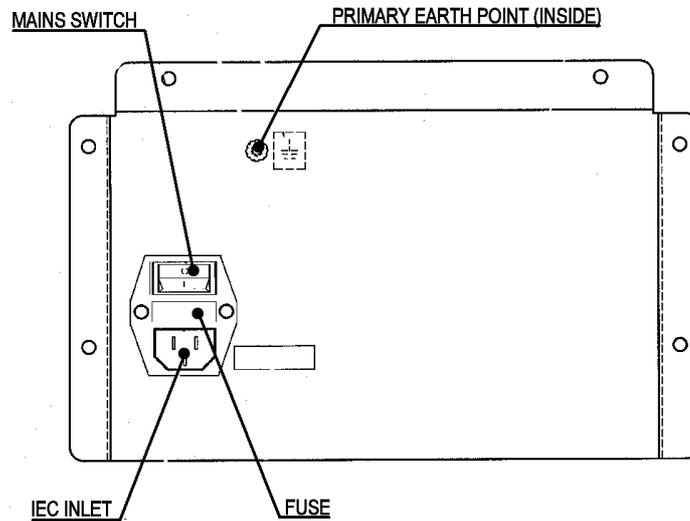



### 3.5. MOVING THE MACHINE



- When moving the machine, be sure to remove the plug from the power supply. Moving the machine with the plug inserted can cause the power cord to be damaged, resulting in a fire or electric shock.
- When moving the machine, retract the leg adjusters fully. During movement pay careful attention so that the casters or leg adjusters do not damage any other cabling laid on the floor. Such damage could result in a fire or electric shock.
- Do not push the upper part of the cabinet. Failure to observe this can cause the cabinet to fall forwards and result in accidents.

- When transporting the machine, be sure to hold the handles on the rear of the cabinet. Inclining the machine by holding portions other than the handles can damage the cabinet and/or the floor surface.
- Do not push the pop panel. Failure to observe this may damage the installation portions and may cause unexpected accidents.

- The machine weighs approximately 100Kg and should only be moved by a minimum of 2 people.



To move the machine:

1. Using the handles at the back of the cabinet, tilt the cabinet back until it is balanced safely on the rear castors. **EXTREME CARE SHOULD BE TAKEN DURING THIS OPERATION TO AVOID INJURY OR DAMAGE TO THE MACHINE.**
2. Carefully roll the machine to the desired position.
3. Tilt cabinet forward until front legs are in contact with the ground – **CAUTION, THE MACHINE MAY PULL FORWARDS.**
4. Adjust the leg adjusters to ensure cabinet is square and steady if required.

### 3.6. ELECTRICAL ASSEMBLY



- Before performing work, be sure to turn power off. Working with power on can cause an electric shock or short circuit.
- Use care to ensure the wiring is not damaged. Damaged wiring can cause electric shock or short circuit.
- Touching parts of the machine other than those specified here can cause electric shock or short circuit.



- This procedure to be carried out only by QUALIFIED SERVICE PERSONNEL.

#### 3.6.1. REMOVING THE ELECTRICAL ASSEMBLY

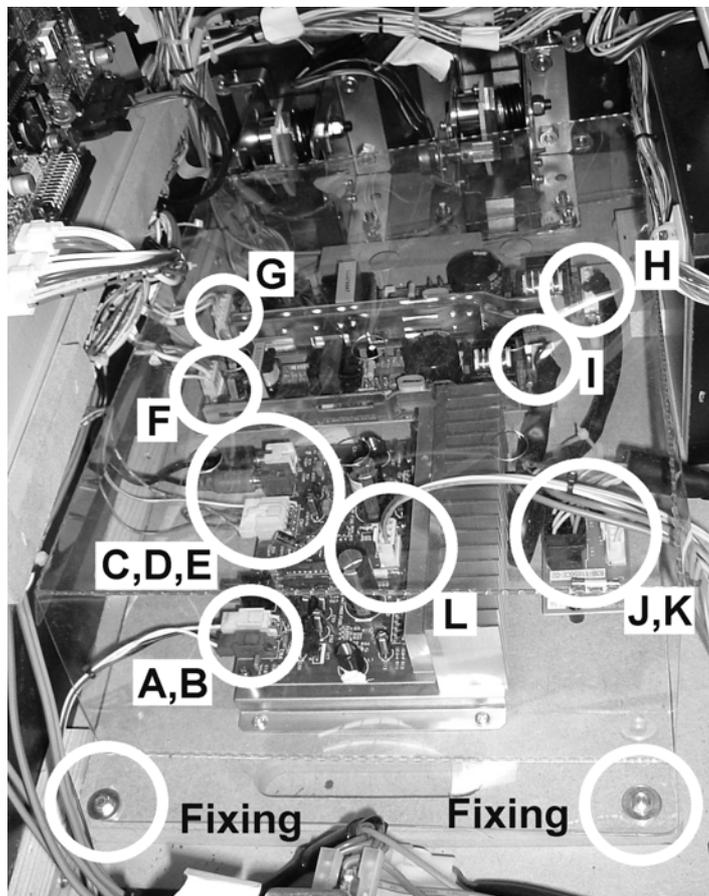

1. Remove the two fixings (bolt m4x30 and washer) securing the board.
2. Remove the plastic board cover.
3. Uncouple the loom connectors A to L.
4. Carefully slide the board out from the rear of the cabinet ensuring no damage takes place to the board.

### 3.7. CONTROL PANEL



- Before starting work, ensure that the cabinet is isolated from the mains by switching off and removing the IEC mains lead from the wall outlet.
- Be careful not to damage wiring. Damaged wiring can cause electric shock and short circuits.

#### 3.7.1. REPLACING THE CONTROL PANEL

1. Power OFF the machine and remove the IEC lead from the wall outlet.
2. Remove the 2 M6 security screws on the top of the Panel.
3. Unlock the Control Panel using the Control Panel Key and open the Panel.
4. Disconnect the looms and the earth tag.

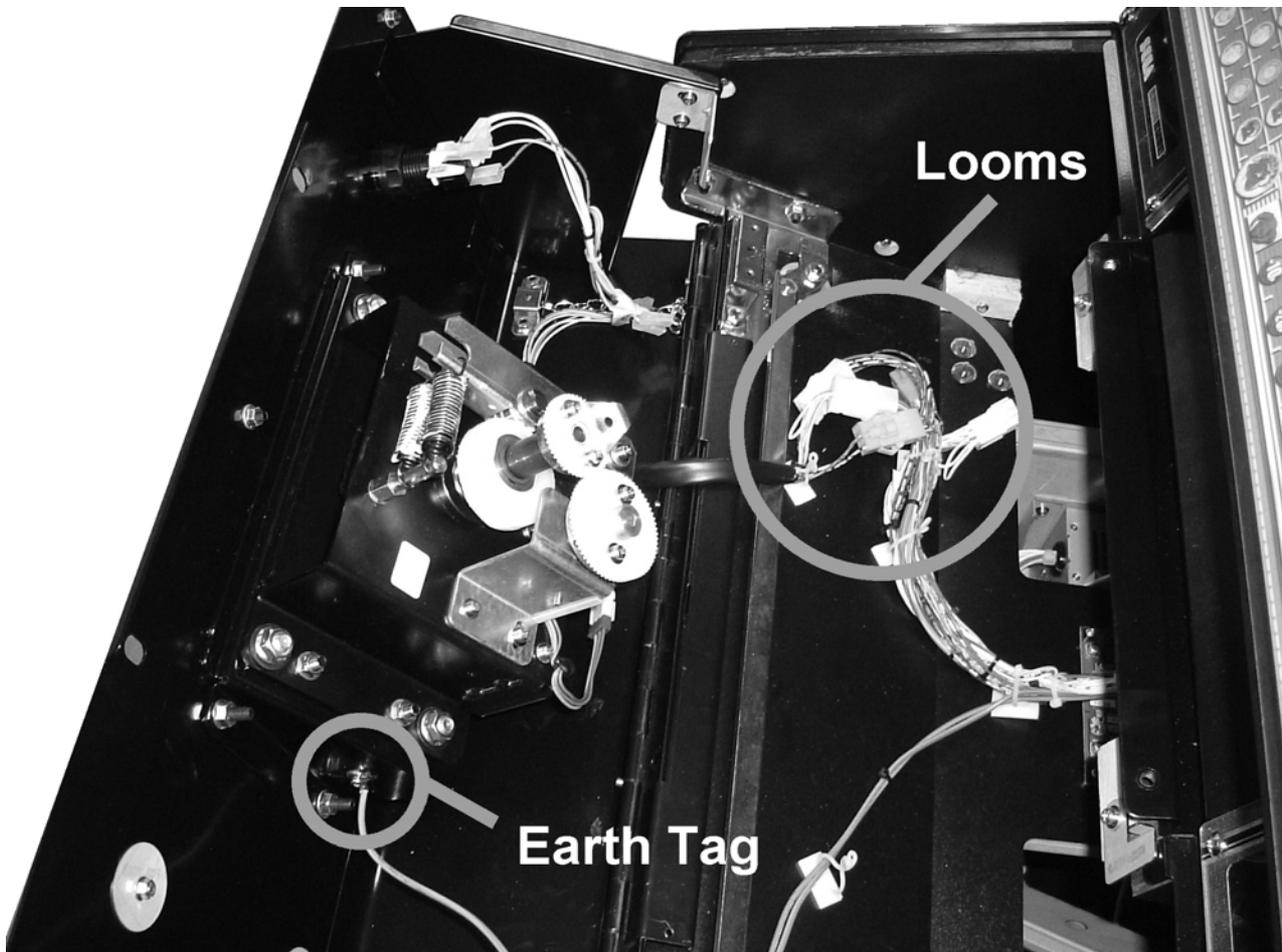

Note: This illustration may not reflect the actual control panel shipped.

5. Remove the 6 bolts that secure the Control Panel in place.



Be sure to support the weight of the control panel when doing this!!

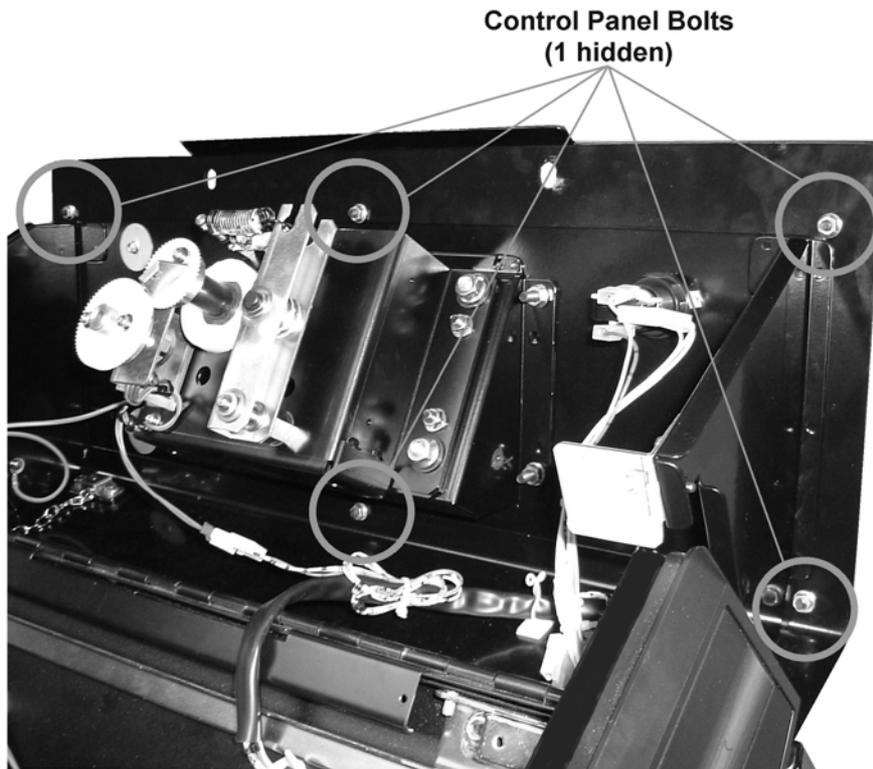

Note: This illustration may not reflect the actual control panel shipped.

6. Remove the Control Panel

### 3.8. ACCELERATOR AND BRAKE



- Before performing work, be sure to turn power off. Working with power on can cause an electric shock or short circuit.
- Use care to ensure the wiring is not damaged. Damaged wiring can cause electric shock or short circuit.
- Touching parts of the machine other than those specified here can cause electric shock or short circuit.



- Before starting this procedure, extend the leg adjusters far enough to enable access to the bolts and bolt plates located beneath the cabinet. If the access gap is not sufficient, the machine will have to be tilted or placed in its back
- ***Tilting or placing the machine on its back is a hazardous procedure and should only be carried out by QUALIFIED SERVICE PERSONNEL.***
- The Coin Hopper and Cash Box should be emptied before moving the machine to prevent coins escaping into the cabinet body.

If the operation of the Accelerator and Brake pedals is unsatisfactory and not remedied by adjustment of the VOLUME SETTING in the TEST MODE, the cause may be mesh failure of the Volume Gear or a faulty Volume potentiometer. Follow the procedure below to adjust the Volume Gear mesh or replace the Volume potentiometer.

When the pedals are depressed fully, if the Volume shaft is rotating within the movable range, the Volume is not feared to be damaged. Use the procedure described herein to position the VR such that the correct values are displayed at both extremes of pedal travel.

**Note:** *It will be easier to remove the Pedals if the Electrical Assembly is removed beforehand. See Section 3.6.1 for information on how to remove the assembly.*

#### 3.8.1. REMOVING THE PEDALS

*Note: The pedals may differ slightly from those illustrated.*

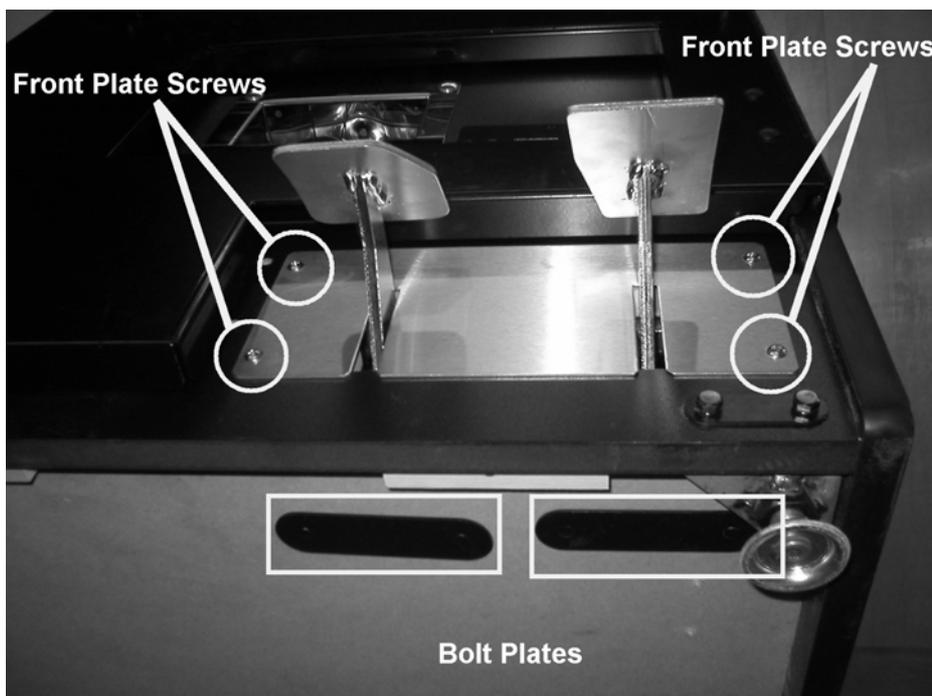

1. Turn the power switch OFF and remove the IEC cable.
2. Remove the four Front Plate screws then slide the Plate up and away from the pedals.

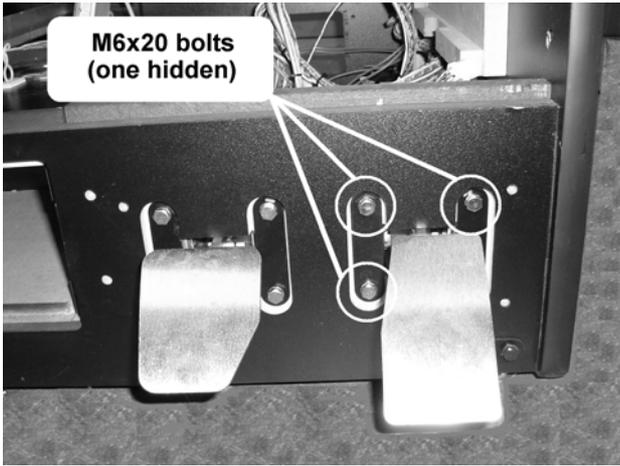

3. Remove the four pedal bolts (per pedal) securing the pedal to the front of the cabinet.

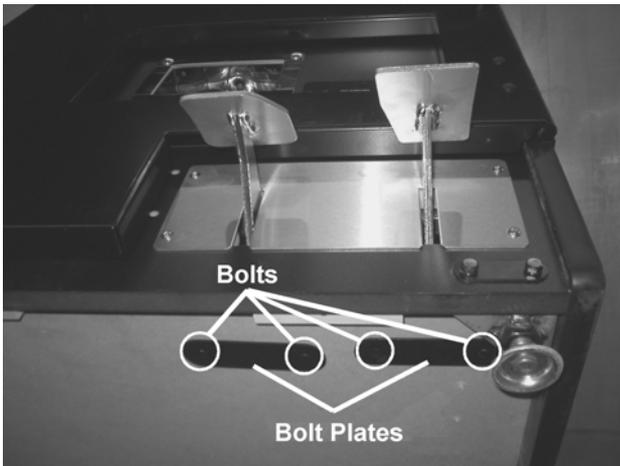

4. Remove the bolts and bolt plate from beneath the cabinet.

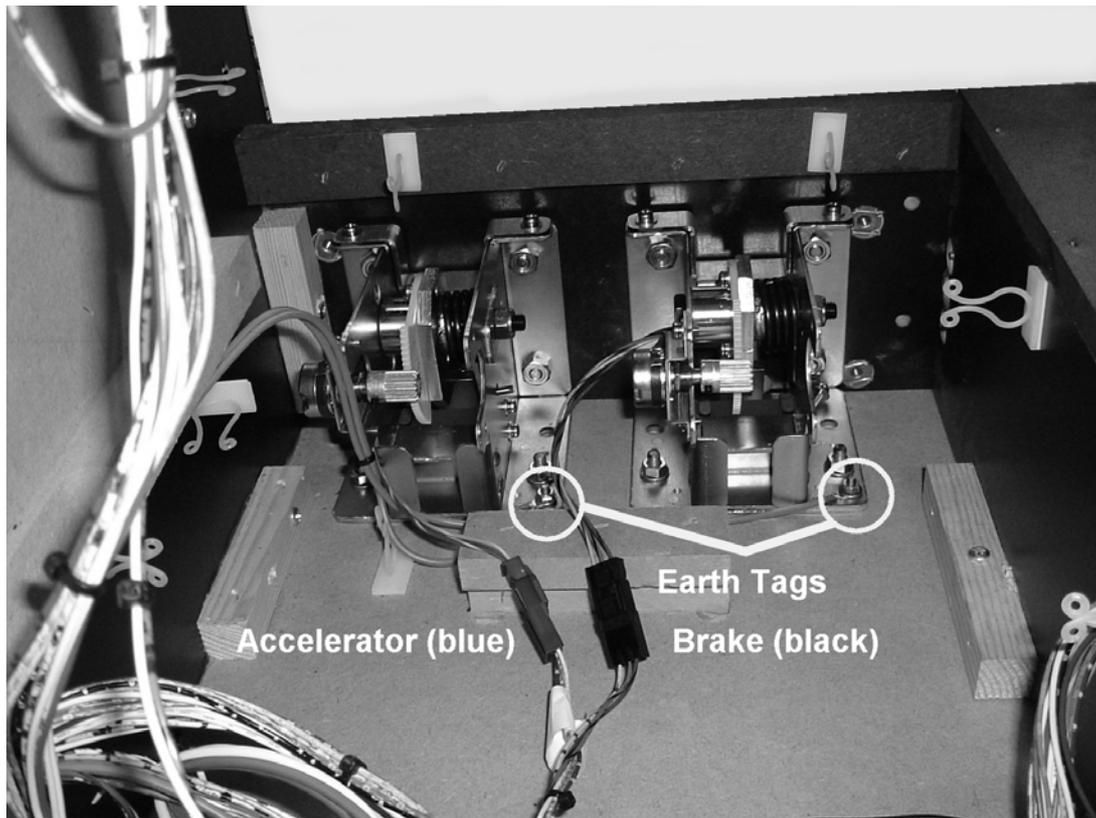

Note: In this illustration the Electrical Assembly is removed.

5. Disconnect the earth tag and connector block.

The connector block colours are as follows:  
Blue = Accelerator, Black = Brake.

6. The Pedal can now be removed by sliding it into the cabinet.

### 3.8.2. ADJUSTING OR REPLACING THE VOLUME

#### ADJUSTMENT:

1. Loosen the grub screw, and adjust the volume angle for optimum gear mesh.
2. Tighten the grub screw.
3. Check the volume setting in Section 8.2.6.

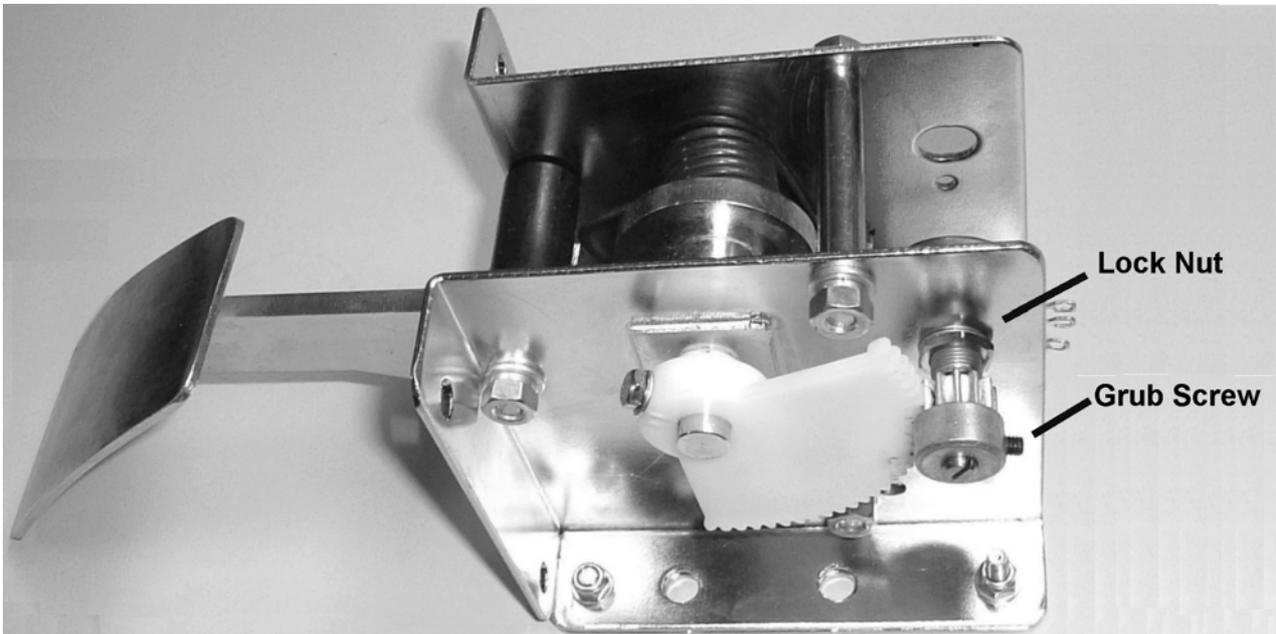

#### REPLACEMENT:

1. Loosen the grubscrew.
2. Slide off the gear cog.
3. Undo the lock nut.
4. Remove the volume.
5. Re-install in reverse order.
6. Check the volume setting in section 8.2.6



### 3.8.3. GREASING



- When performing work, be sure to turn power off. Working with power on can cause an electric shock or short circuit.

- Use only synthetic grease (grease or spray) as plastic parts are used. Do not use mineral based greases.
- Applying grease to parts other than those specified can cause malfunctioning or quality deterioration of parts.

Apply grease to the gear mesh portions once every three months. Use a proprietary synthetic lubricant..

### 3.9. GAME BOARD



- When performing work, be sure to turn power off. Working with power on can cause an electric shock or short circuit.
- Be careful not to damage wiring. Damaged wiring can cause an electric shock or short circuit.
- The voltage/amperage ratings for the Game Board are 3.3V 12A, 5.0V 10A and 12V 2A. To avoid risk of fire, never use any board with supply requirements exceeding the above.
- When replacing the Game Board with one not of JAMMA standard, be sure to use only the harness supplied by the manufacturer of the Game Board. Using other harnesses constitutes a fire risk.

#### 3.9.1. TAKING OUT THE GAME BOARD

To take out the game board, remove together with the wooden base on which the Game Board is mounted.

1. Turn power OFF by removing the IEC lead from the wall socket.
2. Disconnect all of the connectors A to H as shown below.

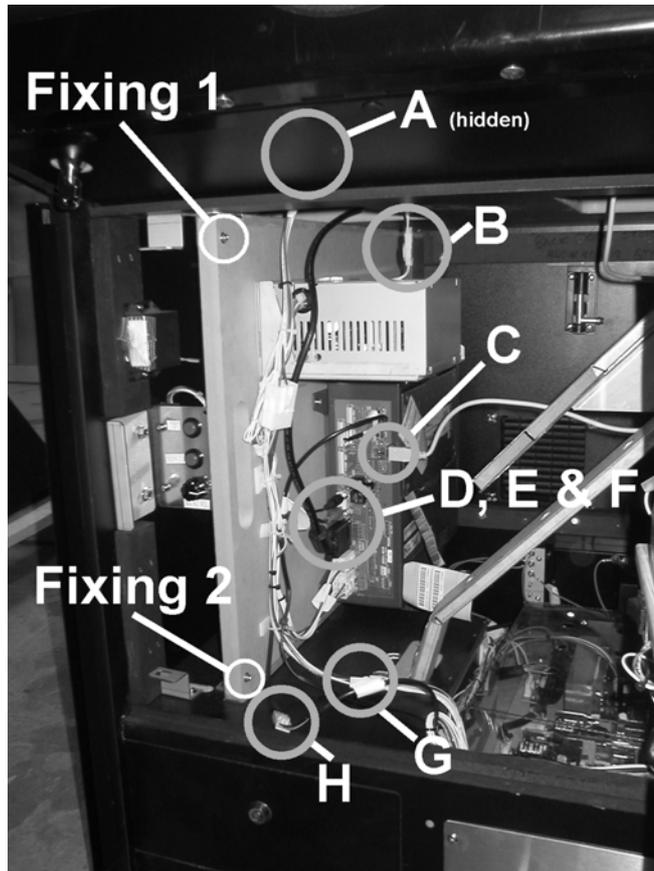

3. Remove fixings 1 and 2.
4. Slide the board assembly out from the cabinet being careful to avoid any damage during removal.

### 3.9.2. COMPOSITION OF GAME BOARD

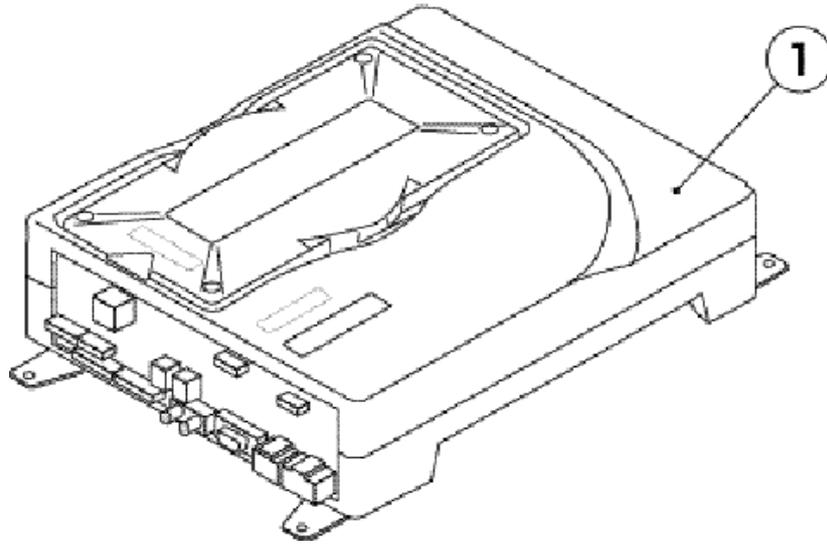

	PART NO.	DESCRIPTION
1	840-0137D-02	ASSY CASE NAT CKT PUB EXP

### 3.10. MONITOR ADJUSTMENT

The monitor adjustment pcb is located behind the logo plate on the opposite side to the coin entry bezel.

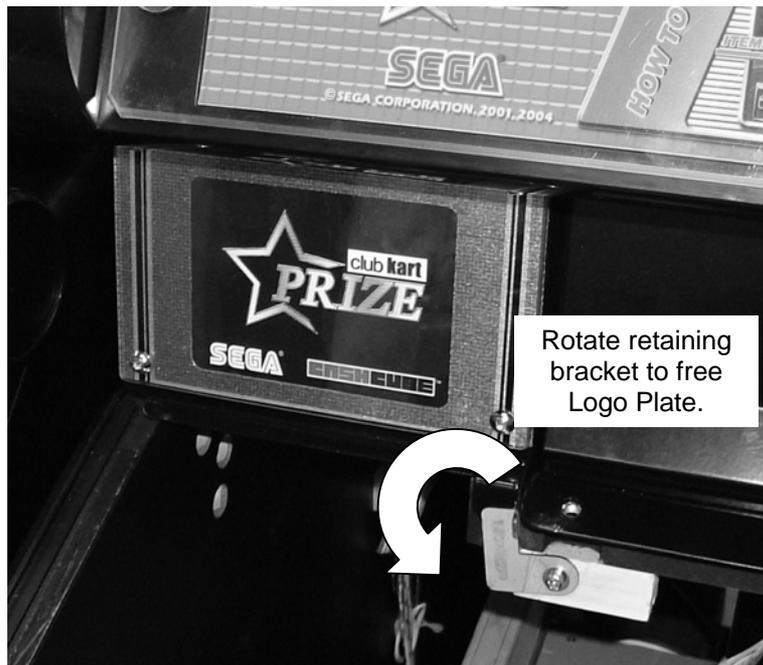

To gain access to the pcb:

1. Open the control panel after removing the two M6 security screws and using the Control Panel key (see section 3.7.1).
2. Loosen the retaining bracket held on with 1 M4 screw to the lower right of the Logo Plate. This allows the bracket to rotate enabling the Logo Plate to be removed.
3. The Monitor Adjustment pcb is located directly behind this plate.



**Note:**

Problems with the monitor that cannot be corrected by simple adjustment using the pcb are beyond the scope of this manual. Please refer to the monitor manufacturer for further information.

Pentranic Limited.  
4 Michaelson Square  
Kirkton Campus  
Livingston  
Scotland  
UK  
EH54 7DP  
[www.pentranic.com](http://www.pentranic.com)

### 3.11. TROUBLESHOOTING



- Only QUALIFIED SERVICE PERSONNEL should carry out these procedures.

If a problem occurs, first check the wiring connections.

PROBLEMS	CAUSE	COUNTERMEASURES
When the main switch is turned ON, the machine is not activated	The power is not ON.	Firmly insert the plug into the outlet.
	Incorrect power source/voltage.	Make sure that the power supply/voltage are correct.
	AC Unit CIRCUIT PROTECTION DEVICE (i.e.; fuse) was activated due to an instantaneous overcurrent.	First, remove the cause of overcurrent and reinstate the circuit protection device to its original status. Then identify the cause of the fault on the item which caused the overcurrent & fix.
The colour image on the screen is incorrect	Incorrect monitor adjustment.	Make appropriate adjustments. Refer to section 3.10.
The on-screen image of the monitor sways and/or shrinks	The power source and voltage are not correct.	Make sure that the power supply and voltage are correct.
Sound is not emitted	Sound volume adjustment is not correct.	Adjust the volume setting located near the Test and Service switches.
	Malfunctioning BD and Amp.	Perform Sound Test to check it.
	Connector connection is incorrect	Check connector connection from Base to Speaker
The fluorescent lamp does not light up	Fluorescent lamp needs replacement	Replace the fluorescent lamp.
	The connector is disconnected	Check connector connections behind the monitor mask.
No coin recognition. Or Poor coin acceptance rate	Coin mech dirty.	Clean mech.
	Coin mech faulty.	Replace coin mech.
	Bad loom connections.	Check all harness connections for loose wires and fitments.
	Mech not programmed.	Replace mech.
	Payout Gameboard faulty.	Replace Payout Gameboard.
Machine not paying out.	No coins or coins jammed in Hopper.	Add coins or clear jam.
	Faulty Hopper or Hopper drive PCB	Replace hopper or drive PCB
	Faulty Hopper internal or external loom to motherboard or drive PCB	Check connectors.
	24V DC fuse blown on hopper drive board.	Check fuse.
	Payout Gameboard faulty.	Replace Payout Gameboard.

### **3.12. HOPPER ASSEMBLY**

The machine uses a Coin Controls 24V DC hopper assembly.

#### **3.12.1.HOPPER OPERATION**

Each disc contains a number of holes in which coins are held in short stacks. The motor drives the disc via a gear train. As the disc rotates, the coin at the bottom of one of the stacks will make contact with the ejector fingers and start to push the fingers back. Further rotation of the disc will cause the coin to start to move outwards into the exit slot. At this point the spring will be free to pull the ejector fingers forward and push the coin through the exit slot.

A LED transmitter and opto-receiver form an optical detector. The infrared light beam is routed across the exit slot via a light guide. When coin passes through the exit the light beam will be broken and coin output signal will be generated.

The hopper will automatically brake when power is interrupted, or machine placed in the off state, thus preventing overrun and excessive coin payout.

An over current detection circuit reverses the hopper momentarily in the event of a coin jam, and then attempts to continue payout. This oscillation of the disc will continue until either the coins are freed, the hopper is switched off, or the overload trip switches. Should the latter occur the hopper supply must be disconnected, the fault condition must be corrected and the trip be allowed time to cool (Approx. 30 seconds) before the hopper will start.

#### **3.12.2.HOPPER ASSEMBLY FAULT FINDING**

##### **Coins fail to unjam**

1. Ensure coin exit clear.
2. Ensure no incorrect coins or foreign objects are in the hopper.
3. Ensure no badly bent coins in hopper.

##### **Clearing a coin jam**

1. Open the Outer and Service doors to gain access to the Hopper area..
2. Detach the metalwork surrounding the hopper by removing the 2 screws and 3 nuts that hold it in place.
3. Remove all coins from bowl.
4. Remove motor assembly from base.
5. Clear the jammed coin by either:
  - a. Rotating the disc manually first anti-clockwise then clockwise to free the coin.
  - OR b. Push the coin back in using the edge of similar coin.

NB. Common cause is damaged or bent coins. Do not return damaged coins to bowl.

6. Remove any debris from the disc bed assembly.
7. Clean the exit window opto with a clean dry cloth.
8. Reassemble as described earlier.
9. Refill and test the hopper.

##### **Motor fails to run.**

1. Check 24v 5A fuse on the Hopper Drive Board.
2. Hopper over-current protective device tripped (Wait 30 seconds while supply off).

##### **Over payout of coins**

1. Check opto area/coin exit for dirt.

##### **Under Payout of coins**

1. Ensure hopper contains sufficient coins.
2. Poor connection (check common return wires) to hopper.

### **Dismantling the Hopper**

1. Gently pull outwards the securing clips on the back of the base.
2. Tilt the bowl forward until it is clear of the clips.
3. Slide the bowl forward until the locating lugs, at the front of the bowl, are clear of the slots in the base.
4. Lift the motor assembly out of the base.
5. Disconnect the cable from the motor assembly.

### **Hopper Assembly**

1. Connect the cable to the motor assembly, ensuring that the 4-pin connector is the correct way round.
2. Lower the motor assembly into the base, ensuring that the coin exit is in the rear exit position. (Towards Coin exit position).
3. Locate the lugs, on the front of the bowl, into the slots at the front of the base.
4. Gently press down until the securing clips, on the base, click into the slots in the bowl.

### **Routine cleaning:**

All accessible parts of the coin route should be cleaned periodically using a mild detergent on a damp cloth. No spray solvents should be used. Particular attention should be paid to the opto sensor at the coin exit to remove any build up of dirt.



### 3.13. COIN MECHANISMS

The machine uses a Coin Controls SR5 Coin Mechanism.

#### 3.13.1.COIN MECHANISM OPERATION (FOR UK MACHINES).

COINS ACCEPTED: 5P, 10P, 20P, 50P, £1, £2

##### COIN ROUTING

The coin mech automatically routes all coins other than £1 coins to the cash box (exit C). £1 coins are routed to the hopper (exit A) until the float is achieved, afterwards they are diverted to the cash box (exit B). The float is maintained by software counting the number of £1 coins entered.

The coin mech exits are as follows:

- A Hopper
- B Cash Box
- C Cash Box
- D Not Used.

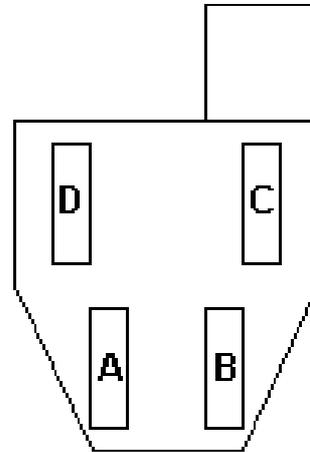

##### SR5 – COIN CONTROL

ROUTING PLUG: 18 WAY

Pt No PUB-64101UK

5-7,8-15,1→13, 10→13, 12→13, 16→13, 17→13, 18→13

The diode direction is shown as '→'.

*Note: Cash Payout - £1 Hopper only fitted.*

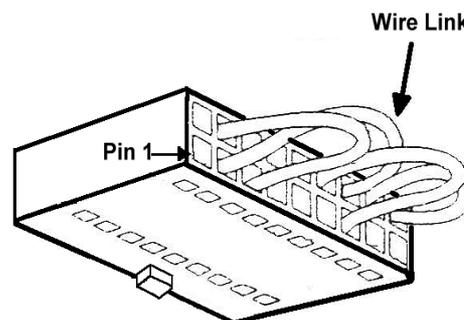

#### 3.13.2.COIN MECHANISM FAULT FINDING

There is a green diagnostic LED used to provide a visual indication of the mechanisms current operation and error condition.

1. LED ON = Power ON
2. LED OFF = Power OFF
3. LED will flash OFF once when Coins or Tokens are accepted or if reject Lever is pressed.
4. LED will flash OFF twice if Coin or Token is unrecognised.
5. LED will flash OFF three times if validator or machine has inhibited Coin or Token.
6. LED will flash continuously when in Token Teaching Mode.

For further information on the operation of the coin mechanism, please refer to the Money Controls website:

[www.moneycontrols.com/support/](http://www.moneycontrols.com/support/)

### 3.14. FUSES



- Never touch places other than those specified. Touching places other than those specified can cause electric shock and short circuit. Disconnect the machine from the supply before attempting the replacement of any fuse.

- Only QUALIFIED SERVICE PERSONNEL should replace FUSES.
- Only replace fuses with ones of the same value and type.

There are a number of fuses used on this machine to protect the user and the machine from damage. Only replace the fuse once you have removed the cause of its failure. Detailed below is a list of the fuses used, their location and if relevant PCB reference:

PART NUMBER	LOCATION	TYPE & DETAILS	QTY
514-5078-3150	STEREO AMP REF. F1, F2	5x20mm CERAMIC SB 3.15A	2
514-5078-4000	SWITCH REG REF. F1	5x20mm CERAMIC SB 4A	1
514-5078-5000	IEC INLET REF. F1	5x20mm CERAMIC SB 5A	1
514-5078-6300	CONN. BD. REF. F1	5x20mm CERAMIC SB 6.3A	1

There are also fuses located on the Monitor PCB. Refer to the monitor manufacturer for further information.

## 4. REFILL MODE

### 4.1. WHAT IS REFILL MODE?

The REFILL MODE is used to refill the Hopper with coins or to pay out coins from the Hopper. To enter REFILL MODE, hold the Key Switch in the "ON" position for around one second. Setting the Key Switch back to "OFF" will then exit REFILL MODE. Except during game play or in Test Mode, REFILL MODE can be accessed at any time. However, it is possible to enter REFILL MODE during game play if a "HOPPER EMPTY" error occurs.

There are two different submodes used in REFILL MODE, depending on the status of the machine doors. When the doors are closed, "LANDLORD REFILL" is used, and when the front door or cash door are open, "COLLECTOR REFILL" is used.

### 4.2. LANDLORD REFILL

During LANDLORD REFILL, a screen like the one below will be displayed.



LANDLORD REFILL Screen

Display	Meaning
LAST WIN	The number of wins in the last game.
FLOAT	The number of coins in the Hopper. (current number / maximum number) Any coins inserted beyond the maximum number will be diverted to the Cash Box.

During LANDLORD REFILL, the Hopper coin stock can be replenished by inserting coins into the coin slot. It is possible to fill the Hopper up to the FLOAT maximum value setting (shown as 70 in the above table). LAST WIN and FLOAT values will not be displayed under the default settings. To display these values, change the display option in the MEMORY SETTING section of the HOPPER BOARD TEST Menu.

### 4.3. COLLECTOR REFILL

During COLLECTOR REFILL, a Screen like the one below will be displayed.



COLLECTOR REFILL Screen

Display	Meaning
IN	Total number of coins inserted.
OUT	Total number of coins paid out.
REFILL	Total number of coins refilled.
LAST WIN	Same as LAST WIN in LANDLORD.
FLOAT	Same as FLOAT in LANDLORD.
DUMP	Number of coins paid out with Dump Switch.

In COLLECTOR REFILL mode, the Hopper coin stock can be replenished just like in LANDLORD, only in COLLECTOR REFILL mode, coins can be added directly into the Hopper.

After refilling coins directly into the Hopper, be sure to press the Top Up Switch and set the FLOAT current coin number to the maximum coin number. Neglecting to set the current coin number could result in a coin overflow.

Also note that pressing the Dump Switch will release the entire Hopper coin stock.

#### 4.4. DEALING WITH A HOPPER EMPTY ERROR

Following is the procedure for dealing with a HOPPER EMPTY/JAM error:

1. Get a WIN in the game.
2. Payout will commence.
3. The error occurs (as shown in the figure below).
4. Set the Key Switch to ON and enter REFILL MODE.
5. Refill the coin stock.
6. Setting the Key Switch to OFF will exit REFILL MODE and return to payout.
7. End the game.



HOPPER EMPTY / JAM Error Occurrence 1



HOPPER EMPTY / JAM Error Occurrence 2

#### **4.5. METERS**

The machine is fitted with three mechanical meters that record the following information:

- Total Coin In  
Total of all the coins fed in through the coin mechanism.
- Total Coin Out  
Total of all the coins paid out from the hopper.
- Total Coin Refill  
Total of all the coins refilled through the coin mechanism

*Note: These meters cannot be reset and therefore record the totals since the machine was delivered.*

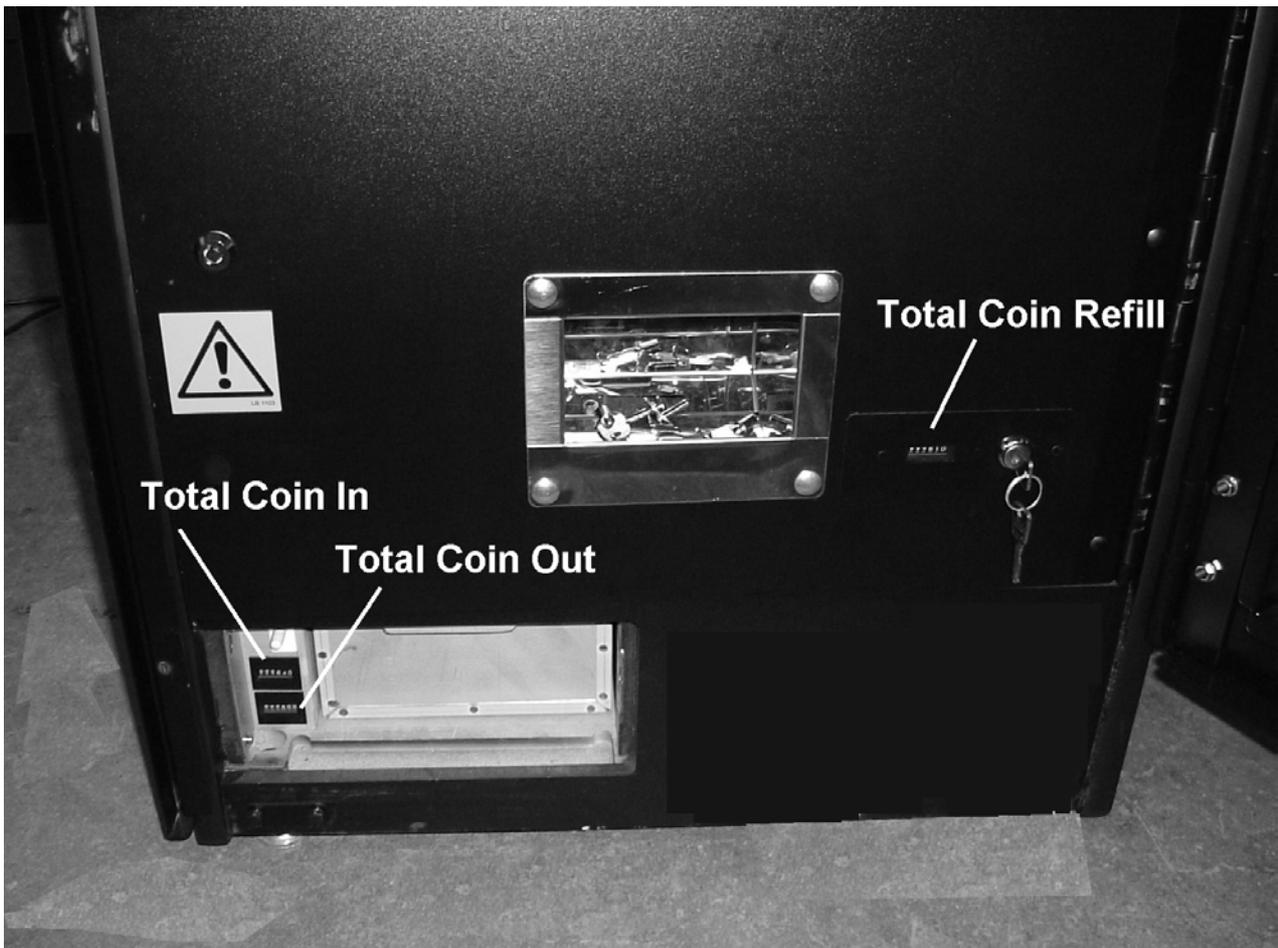

## 5. DATAPORT

### 5.1. WHAT IS THE DATAPORT?

The DATAPORT is a data organization device used to aid U.K. AWP/SWP income collection. The DATAPORT, when connected to the game unit, can exchange information with the HOPPER BOARD machine regarding settings and states, coin IN/OUT quantities, etc. via serial data transfer.

The DATAPORT and HOPPER BOARD share information, and typically when there is no response from the DATAPORT an error will occur, but settings can be changed to prevent this from happening.

This change is made in the DATAPORT SETTING of the HOPPER BOARD TEST Menu (see section 8.2.4.6). The Menu item, however, is not normally displayed among the other setting selection items. Displaying the Menu item requires a special dongle, explained in the next section (SETTING PROCEDURE).



DATAPORT SETTING Menu.

### 5.2. SETTING PROCEDURE

The following procedure explains how to use a dongle to access the DATAPORT SETTING Menu and change the aforementioned error display setting:

1. Make sure power is off and connect dongle.
2. Turn on power.
3. Enter HOPPER BOARD TEST Menu.
4. Change setting in DATAPORT SETTING.
5. Turn off power.
6. Disconnect dongle.
7. Turn on power.

### 5.3. DATAPORT SETTING

In the DATAPORT SETTING Menu, two setting values can be changed.

The OPTION setting determines whether or not the HOPPER BOARD watches over communications from the DATAPORT, and the CONDITION setting controls whether the OPTION setting is active perpetually or temporarily.

Menu Item	Content	Setting Type
OPTION	PROTOCOL setting	PROTOCOL (watches over DATAPORT) / NON-PROT (does not watch over DATAPORT)
CONDITION	OPTION setting type	FOREVER (perpetual) / TEMP (temporary)

Setting the CONDITION to TEMP will not eliminate the DATAPORT SETTING Menu item, however setting CONDITION to FOREVER will render it hidden. The Menu item will remain hidden until connecting the dongle as mentioned above.



DATAPORT SETTING Menu

Setting CONDITION to TEMP will result in the following screen (blue window) coming up whenever restarting an application. Turning the Key Switch ON and OFF again will allow the application to startup.



Startup Screen with TEMP Setting



#### 5.4. ERROR

With CONDITION set to PROTOCOL, an error (#202) will result when there is no response from the DATAPORT. This error will be cancelled when there is a normal response from the DATAPORT.



Error #202 Screen

## 6. PERIODIC CHECK AND INSPECTION

The items listed below require periodic check and maintenance to retain the performance of the machine and ensure safe operation:



- Be sure to check annually to see if the power cords are damaged, the plug is securely inserted and that there is no dust in the interior of the machine or between the socket and the power cord. Using the product in an unclean condition may cause a fire or electric shock.

DESCRIPTION	WHAT TO CHECK	INTERVAL
CABINET	Check Adjusters' contact with surface	Daily
MONITOR	Cleaning CRT face	Weekly
	Check settings	Monthly
GAME BD	Setting check	Monthly
CONTROL PANEL	Input test	Monthly
Speaker, sound	Sound test, check volume adjustment	Monthly
COIN SELECTOR	Coin insertion test	Monthly
	Cleaning	Tri-Monthly
POWER SUPPLY CORD	Check condition	Annually
INTERIOR	Clean ( <b>Do Not</b> use water jet)	Annually
CABINET SURFACE	Clean ( <b>Do Not</b> use water jet)	As required

### 6.1. CLEANING THE CABINET SURFACES

When the cabinet surfaces are badly soiled, remove stains with a soft cloth dipped in water or chemical detergent (diluted with water) and squeezed dry. To avoid damaging surface finish, do not use such solvents as thinner, benzene, etc. (other than ethyl alcohol), abrasives or bleaching agents. **DO NOT USE A WATER JET.**

## 7. CONTENTS OF GAME

### 7.1. HOW TO PLAY: POUND SETTING

1. Insert Coin
2. Press START BUTTON
3. Select the difficulty level between; novice, intermediate, difficult by using the steering, and then confirm by pressing ACCELERATOR UNIT or START BUTTON.
4. DOSH DASH RACE  
If you fail to reach goal within the time restriction it will be GAME OVER.

There are many items within the circuit. Aim for star mark, avoid for skull mark, and then attempt to reach the goal within the time restriction.

Time bonus will be added when reaching goal, try for further bonus time by reaching goal in certain time period.



5. ALL OR NOTHING STAGE



Please press BRAKE UNIT in proper time, taking wind gauge in account, to stop KART within STOP AREA.

The ACCELERATOR UNIT will NOT be used.



If you succeed, you can win the prize achieved in "4.DOSH DASH RACE".

If you fail, it will be GAME OVER.

6. Continue

If you fail in 5. ALL OR NOTHING STAGE, you can retry ONCE.  
If you wish to continue, please insert coin within time restriction.

## 7. DOUBLE UP CHALLENGE



- For UK operation, this stage should not be enabled (see section 8.2.3). This stage will be factory defaulted to OFF .

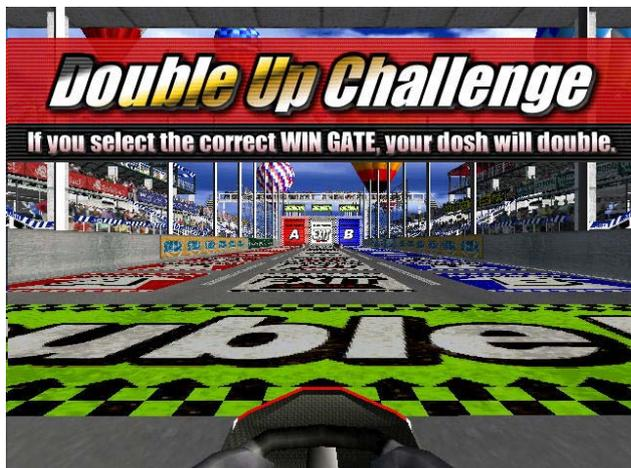

If you succeeded in both above 5 & 6, you have a chance of doubling up the prize. Look carefully for WIN and LOSE door, and aim for WIN gate.



If you WIN prize doubles, but if you LOSE it will be GAME OVER and no prize paid out.

This "7. DOUBLE UP CHALLENGE" feature can be either set ON or OFF.

## 8. EXPLANATION OF TEST AND DATA DISPLAY

Use the switches on the VTS to enter the TEST MODE. This will allow you to carry out post installation and periodic checks and adjustments. The following section details the function of each of the tests:

ITEM	DESCRIPTION	INTERVAL
INSTALLATION OF THE MACHINE	<p>When the machine is installed perform the following checks:</p> <ul style="list-style-type: none"> <li>• Check to see that each setting is as per the standard settings input at the time of shipment.</li> <li>• In the INPUT TEST mode, check each switch and V.R.</li> <li>• In the OUTPUT TEST mode, check each of the lamps.</li> <li>• In the MEMORY TEST mode check all of the IC's on the IC BD.</li> </ul>	Monthly
MEMORY	<ul style="list-style-type: none"> <li>• On the TEST MENU screen choosing the MEMORY TEST allows self-test to be performed. In this test RAM &amp; ROM are tested.</li> </ul>	Monthly
PERIODIC CHECKS	<p>Periodically perform the following</p> <ul style="list-style-type: none"> <li>• MEMORY TEST.</li> <li>• Ascertain each setting.</li> <li>• In the INPUT TEST mode, test the control devices.</li> <li>• In the OUTPUT TEST mode, check each of the lamps.</li> </ul>	Monthly
CONTROL SYSTEM	<ul style="list-style-type: none"> <li>• In the INPUT TEST mode, check each switch and V.R.</li> <li>• Adjust or replace each switch and V.R.</li> </ul>	Monthly
MONITOR	<ul style="list-style-type: none"> <li>• In the C.R.T. TEST mode, check to ensure the monitor is adjusted correctly</li> <li>• Clean screen (switch off machine and remove the plug)</li> </ul>	Monthly Weekly
IC BOARD	<p>MEMORY TEST</p> <ul style="list-style-type: none"> <li>• In the SOUND TEST mode, check the sound related ROMs</li> </ul>	Monthly
DATA CHECK	<ul style="list-style-type: none"> <li>• Check such data as held in the bookkeeping screens, relating to number and length of plays</li> </ul>	Monthly
EXTERIOR MAINTENANCE	<ul style="list-style-type: none"> <li>• Clean surfaces</li> <li>• Lubricate seat sliders</li> </ul>	Monthly
COIN MECHANISM	<ul style="list-style-type: none"> <li>• Check switch operation (if fitted)</li> </ul>	Monthly

## 8.1. SYSTEM TEST MODE



- Setting changes made in SYSTEM ASSIGNMENTS, COIN ASSIGNMENTS and GAME TEST MODE are stored only when the TEST mode is exited properly. If the power is turned off before exiting, and changes made will be ineffectual.
- Do not activate any system test mode while the system is reading the GD-ROM (if fitted), otherwise error messages may appear.
- Only QUALIFIED SERVICE PERSONNEL should carry out these procedures.

The SYSTEM TEST MODE allows the IC Board to be checked for correct operation, monitor colour to be adjusted, and COIN and GAME ASSIGNMENTS to be adjusted.

The Test and Service button are located on the left-hand side of the cabinet behind the service door.

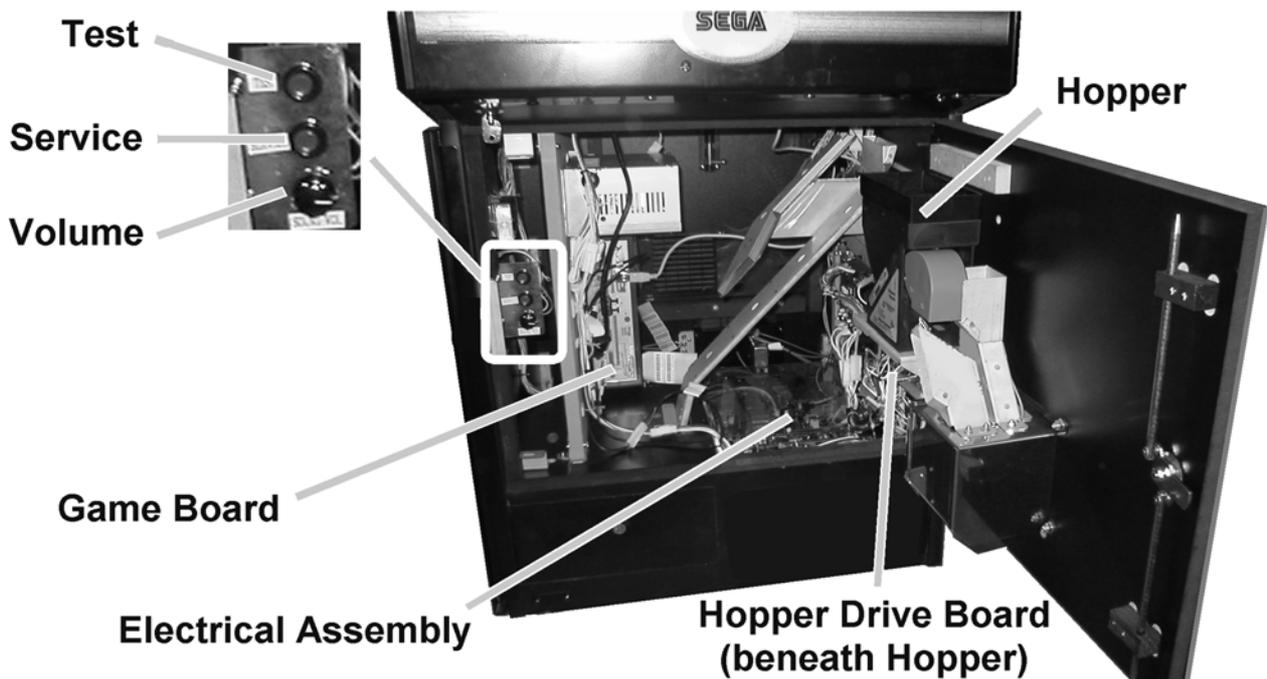

To enter the Test mode:

1. After turning power ON, press the TEST Button to display the following menu:

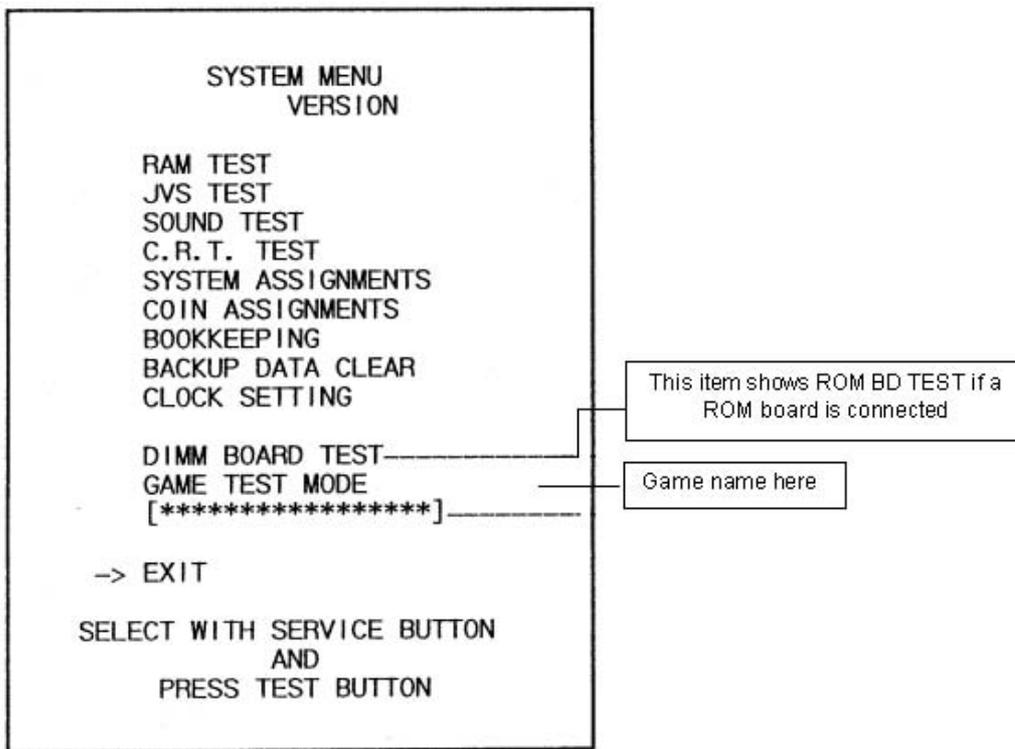

2. Press the SERVICE Button to move the arrow to the desired item, and press TEST to select.
3. Select GAME TEST MODE to display the test menu for that specific game. For further information about GAME TEST MODE, refer to the service manual for the game.
4. Upon finishing the test, select EXIT to return to the game.

### 8.1.1. RAM TEST

This screen carries out a test on the RAM on the NAOMI Main Board. The test begins immediately that the screen appears.

TESTING NOW is displayed while the system is testing.

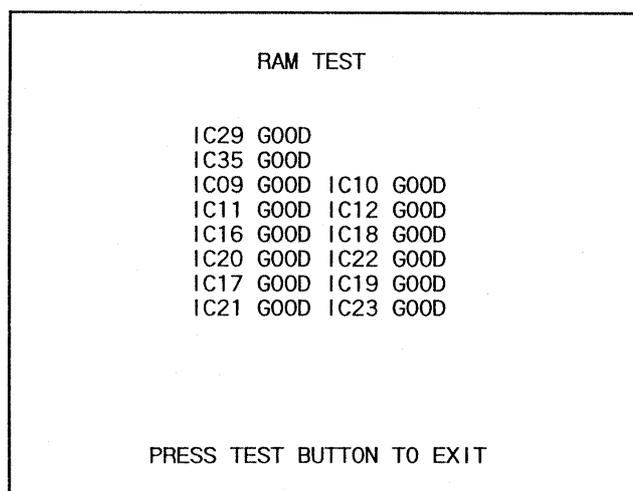

GOOD should appear next to each IC number if the RAM is satisfactory. BAD will appear next to abnormal IC's. The test takes about two and a half minutes to complete testing on all IC's.

After testing, press TEST to return to the system menu screen.





### 8.1.2. JVS TEST

Use this test to check specifications of the I/O Board connected to the NAOMI Main Board, while INPUT TEST can be performed on the input switches. First, I/O Board specifications are displayed.

```

                JVS TEST
                INPUT TEST
                NEXT NODE
                -> EXIT
NODE           1/1
NAME          SEGA ENTERPRISES, LTD.
              I/O 838-18683
              VER 1.04
              98/12
CMD VER       1.1
JVS VER       2.0
COM VER       1.0
SWITCH        2PLAYER(S) 11BITS
COIN          2SLOT
ANALOG        8CH
ROTARY        0CH
KEYCODE       0
SCREEN        X:0 Y:0 CH:0
CARD          0SLOT
HOPPER OUT    0CH
DRIVER OUT    8SLOT
ANALOG OUT    0CH
CHARACTER     CHARA:0 LINE:0
BACKUP        0

SELECT WITH SERVICE BUTTON
              AND
              PRESS TEST BUTTON
```

Select from the following:

INPUT TEST: Proceed to the INPUT TEST of the I/O BOARD displayed.

NEXT NODE: In the case of more than two I/O Boards being connected, this proceeds to the next I/O Board.

EXIT: Returns to the Menu Mode.

### 8.1.3. INPUT TEST SCREEN

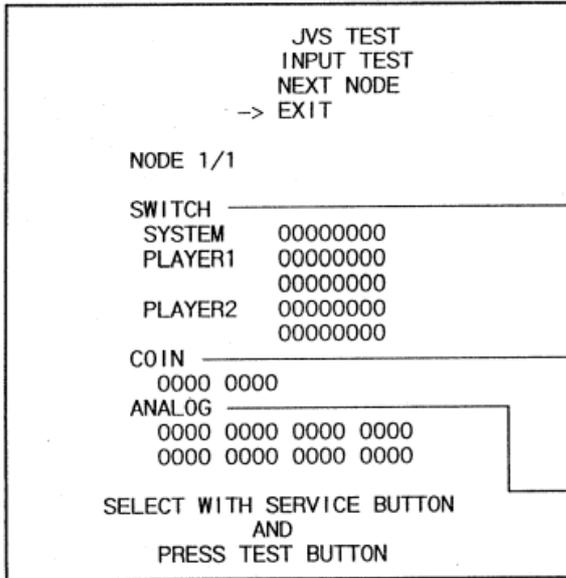

When the control panel switches, etc., are actuated the display changes from 0 to 1.

If the Coin SW is actuated, the counter starts. When TEST mode is exited the display returns to 0000.

Analogue values are displayed between 0000 and FF00.

### 8.1.4. SOUND TEST

Select the sound test to check the status of the amplifiers, sound boards and speakers.

Press the SERVICE button or view change button to move the arrow to the desired test item.

Press TEST button to output the sound.

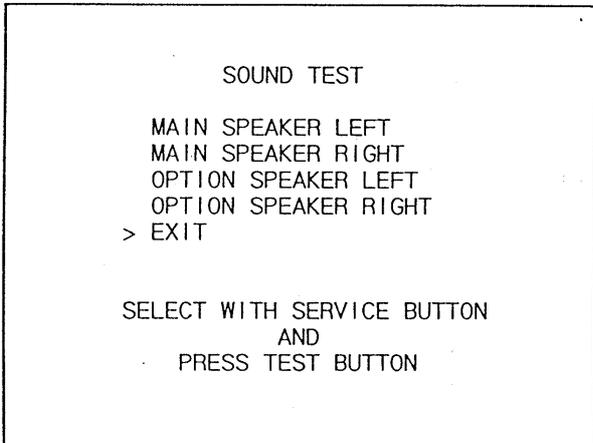

- Select the sound source with SERVICE.
- On pressing TEST, the test sound is emitted from the selected source.

Front speakers are located on the Control Panel.  
Rear speakers are located in the seat back.

Select EXIT to return to MENU screen.

### 8.1.5. CRT TEST

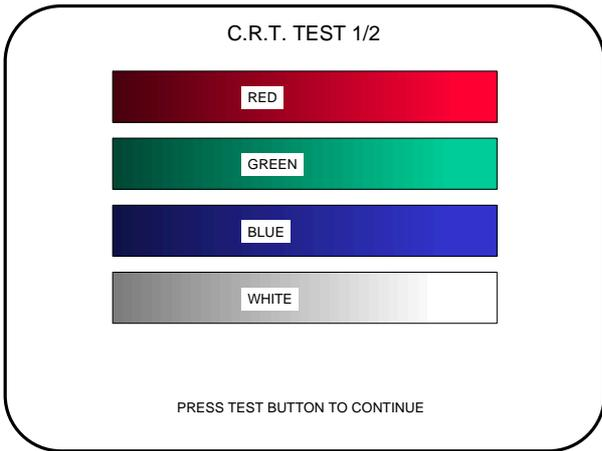

Selecting CRT test allows the projector adjustment to be checked for colour and distortion.

Press the test or start button to have the second CRT test screen appear.

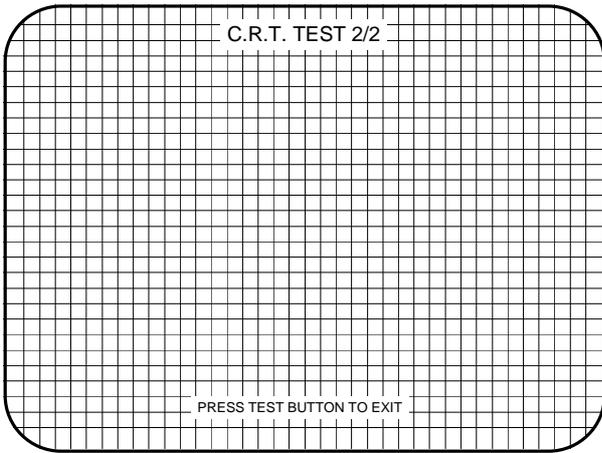

### 8.1.6. SYSTEM ASSIGNMENTS



- If the settings of CABINET and MONITOR TYPE are not suitable for the connected game, an ERROR message is displayed when the game is turned on and TEST mode has finished, and the game cannot be played. Refer to the game's service manual for the correct settings, or enter settings corresponding to the cabinet and control panel specifications.
- Only QUALIFIED SERVICE PERSONNEL should carry out these procedures.

This mode configures the cabinet and board settings. For settings relating to game difficulty, etc., refer to the dedicated service manual for the game software.

1. Select the setting to be changed using SERVICE and TEST.
2. Select EXIT after settings have been performed.

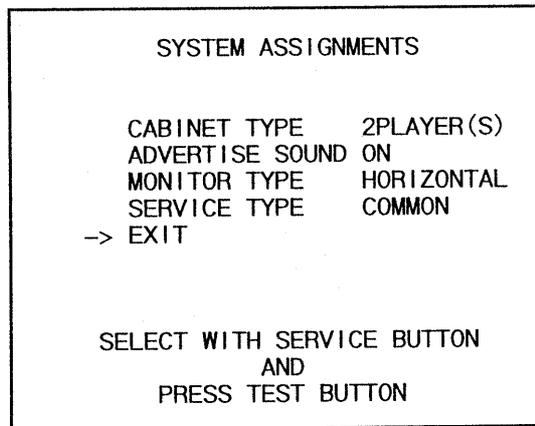

- CABINET TYPE [1PLAYER(S), 2PLAYER(S), 3PLAYER(S), 4PLAYER(S)]  
Sets the number of players between one and four.
- ADVERTISE SOUND (ON, OFF)  
Sets whether ADVERTISE sound is emitted or not.
- MONITOR TYPE (HORIZONTAL, VERTICAL)  
Sets the on-screen display according to the orientation of the monitor.
- SERVICE TYPE (COMMON, INDIVIDUAL)  
If several SERVICE buttons exist, this setting decides the function.  
COMMON: Service credit is obtained for all players when any SERVICE button is pressed.  
INDIVIDUAL: Service credit is obtained for the player corresponding to the SERVICE button used.

## 8.1.7. COIN ASSIGNMENTS

```
          COIN ASSIGNMENTS
COIN CHUTE TYPE      COMMON
COIN/CREDIT SETTING #1
COIN CHUTE #1
    1COIN 1CREDIT

COIN CHUTE #2
    1COIN 1CREDIT

MANUAL SETTING
SEQUENCE SETTING
> EXIT

SELECT WITH SERVICE BUTTON
    AND
PRESS TEST BUTTON
```

Ensure machine is set to 1 Coin 1 Credit.  
Go to Game Test menu for further coin test settings.



### 8.1.10.CLOCK SETTING

YEAR, MONTH, DAY, HOUR and MINUTE are changed in this mode. Select the desired item with SERVICE button and press TEST to increase the value. Select EXIT to return to MENU mode.

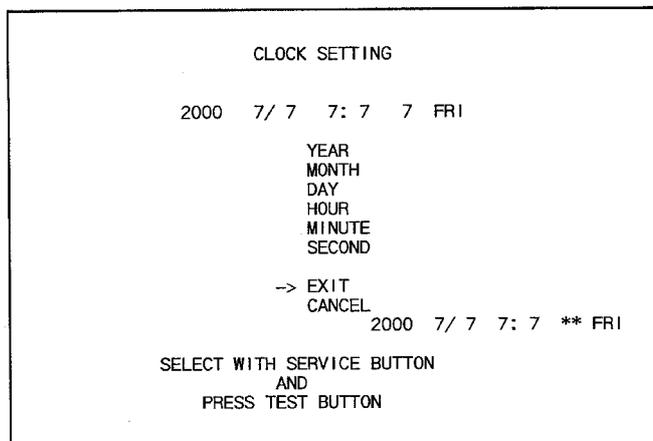

### 8.1.11.DIMM BOARD TEST

This mode appears only if a DIMM Board is connected to the NAOMI. If not, ROM BOARD TEST will appear.

In this test, the DIMM memory and IC's are checked. If GOOD is displayed, it is satisfactory. Press TEST to exit.

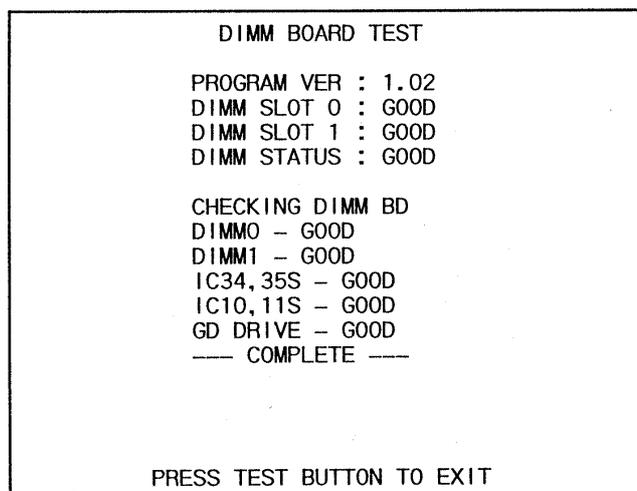



## 8.2. GAME TEST DESCRIPTION MODE

Test menu Flow is: System test → Game test → Hopper Board test

Select GAME TEST MODE from the System Menu screen to display the Game Test Menu screen as shown below.

Use the SERVICE Button to move the cursor to the desired test item. Press the TEST Button to enter the selected item.

### GAME TEST MENU Screen

```
-----  
CLUBKART TEST MENU  
  
INPUT TEST  
OUTPUT TEST  
GAME SETTING  
HOPPER BOARD TEST  
CREDIT SETTING  
VOLUME SETTING  
BOOKKEEPING  
BACKUP DATA CLEAR  
-> EXIT
```

```
SELECT WITH SERVICE BUTTON  
AND PRESS TEST BUTTON  
-----
```

After the test is complete, move the cursor to EXIT and press the TEST Button to return to the System Menu screen.

### 8.2.1. INPUT TEST SCREEN

Select INPUT TEST to display the following screen and check the status of input devices. This test should be used periodically to check that each input device is functioning correctly.

Confirm the status of each switch/button and controller sensitivity levels. Press the switch/button. If it is functioning correctly, the indicator will switch from OFF to ON.

### INPUT TEST Screen

```
-----  
INPUT TEST  
  
STEERING : ****  
ACCEL. : ****  
BRAKE : ****  
START SW : OFF  
(* )BET SW : OFF  
SERVICE : OFF  
TEST : OFF
```

```
PRESS TEST AND SERVICE BUTTON TO EXIT  
-----
```

(\*) This option will only be displayed when CURRENCY is set to TOKEN and BET BUTTON is set to USED.

Press the SERVICE and TEST Buttons simultaneously to return to the Game Test Menu screen.

## 8.2.2. OUTPUT TEST SCREEN

Select OUTPUT TEST to display the following screen and check the status of each lamp.

Use the SERVICE Button to move the cursor to the desired test item. Press the TEST Button to test the selected lamp. ON will light the lamp, and OFF will turn it off.

Doing so will confirm that the lamp and its wiring are functioning properly.

### OUTPUT TEST Screen

-----  
OUTPUT TEST

START LAMP : OFF  
(\*BET LAMP : OFF  
-> EXIT

SELECT WITH SERVICE BUTTON  
AND PRESS TEST BUTTON

-----  
(\* This option will not be displayed when CURRENCY is set to a monetary currency, such as POUND, or when the BET BUTTON of the TOKEN settings is set to NOT USED.

Move the cursor to EXIT and press the TEST Button to return to the Game Test Menu screen.

## 8.2.3. GAME SETTING

Select GAME SETTING to display the current game settings and make changes.

### GAME SETTING Screen

-----  
GAME SETTING

CAR NO. : 1  
CURRENCY : POUND  
(\*LANGUAGE : ENGLISH  
PAYOUT SETTING : 90%  
(\*RISK & RETURN : ON  
DOUBLE UP : ON  
CONTINUE : ON  
(\*ITEM FEATURE : ON  
(\*ITEM ODDS : x5  
(\*JACKPOT ODDS : x40  
-> EXIT

SELECT WITH SERVICE BUTTON  
AND PRESS TEST BUTTON

- **CAR NO.**  
Colour setting for cars appearing in the game. Choose from 1 to 8.
- **CURRENCY**  
Setting for currency used in the game. Choose from POUND, DOLLAR, EURO, ANY CASH, or TOKEN.
- **(\*) LANGUAGE**  
Language setting. RUSSIAN, as well as ENGLISH, is available, except when CURRENCY is set to POUND.
- **PAYOUT SETTING**  
Payout ratio setting, which can be adjusted in 5% increments within the range of 30 – 100%.
- **(\*) RISK & RETURN**  
Game's balance setting.

HIGH:                Within a given game, the payout size = large, and the payout frequency = few.  
MIDDLE:            Between HIGH and LOW.  
LOW:                 Within a given game, the payout size = small, and the payout frequency = frequent.

When CURRENCY is set to TOKEN, however, only HIGH and LOW are available.

- **CONTINUE**  
Determines whether or not the CONTINUE option is available during game play.
- **DOUBLE UP**  
Determines whether or not the DOUBLE UP CHALLENGE option is available during game play.
- **(\*) ITEM FEATURE**  
Determines whether or not the ITEM FEATURE option is available during game play when CURRENCY is set to TOKEN.
- **(\*) ITEM ODDS**  
Determines the probability of "hitting" an ITEM. A setting of "10" equates to the highest probability of hitting, "1" the lowest.  
This option will only be available when ITEM FEATURE is set to ON.
- **(\*) JACKPOT ODDS**  
JACKPOT odds settings, displaying odds multiplication values for a wide range of play units.

#### 8.2.4. HOPPER TEST MENU SCREEN

Select HOPPER BOARD TEST to display the following screen and adjust Hopper-related settings.

-----  
HOPPER BOARD TEST Screen  
-----

HOPPER BOARD TEST

INPUT TEST  
OUTPUT TEST  
COIN TEST  
TROUBLE LOG  
MEMORY SETTING

DATAPORT SETTING  
COIN ASSIGNMENTS

EXIT

SELECT WITH SERVICE BUTTON  
AND PRESS TEST BUTTON  
-----

- |                      |  |
|----------------------|--|
| a) INPUT TEST:       | Executes INPUT TEST.   |
| b) OUTPUT TEST:      | Executes OUTPUT TEST.  |
| c) COIN TEST:        | Executes Hopper COIN TEST.   |
| d) TROUBLE LOG:      | Displays error data encountered.   |
| e) MEMORY SETTING:   | Enters MEMORY SETTING menu.  |
| f) DATAPORT SETTING: | Enters DATAPORT SETTING menu. This will only be displayed under particular setting conditions. |
| g) COIN ASSIGNMENTS: | Allows adjustment of coin value. This will not be displayed when set to POUND.                 |

### 8.2.4.1.INPUT TEST SCREEN

Select INPUT TEST to display the following screen and check the status of input devices.

Press the switch/button. If it is functioning correctly, the START indicator will switch from OFF to ON.

<For POUND, DOLLAR, EURO, or ANY CASH Settings>

-----  
INPUT TEST

RESET KEY SW	[ OFF ] ( ON )
COIN ACCEPT #1	[ OFF ] ( ON )
COIN ACCEPT #2	[ OFF ] ( ON )
COIN ACCEPT #3	[ OFF ] ( ON )
COIN ACCEPT #4	[ OFF ] ( ON )
COIN ACCEPT #5	[ OFF ] ( ON )
COIN ACCEPT #6	[ ON ] ( OFF )
TOKEN IN SW	[ OFF ] ( ON )
HOPPER COUNT SW	[ ON ] ( OFF )
HOPPER TOP UP SW	[ OFF ] ( ON )
DUMP SW	[ OFF ] ( ON )
FRONT DOOR SW	[ CLOSE ] ( OPEN )
BACK DOOR SW	[ CLOSE ] ( OPEN )
CASH DOOR SW	[ CLOSE ] ( OPEN )

PRESS TEST AND SERVICE BUTTON TO EXIT  
-----

Note: The TOKEN IN SW is the switch signal for the mechanical coin selector. This option will not be displayed when set to POUND.

<For TOKEN Setting>

-----  
INPUT TEST

RESET KEY SW	[ OFF ] ( ON )
PAYOUT SW	[ OFF ] ( ON )
COIN ACCEPT #1	[ OFF ] ( ON )
COIN ACCEPT #2	[ OFF ] ( ON )
COIN ACCEPT #3	[ OFF ] ( ON )
COIN ACCEPT #4	[ OFF ] ( ON )
COIN ACCEPT #5	[ OFF ] ( ON )
COIN ACCEPT #6	[ ON ] ( OFF )
TOKEN IN SW	[ OFF ] ( ON )
HOPPER COUNT SW	[ ON ] ( OFF )
HOPPER TOP UP SW	[ OFF ] ( ON )
DUMP SW	[ OFF ] ( ON )
FRONT DOOR SW	[ CLOSE ] ( OPEN )
BACK DOOR SW	[ CLOSE ] ( OPEN )
CASH DOOR SW	[ CLOSE ] ( OPEN )

PRESS TEST AND SERVICE BUTTON TO EXIT  
-----

### 8.2.4.2.OUTPUT TEST SCREEN

Select OUTPUT TEST to display the following screen and check the status of each lamp.

Pressing the TEST Button causes ON to be displayed and the corresponding lamp to light up.  
Pressing the TEST Button again causes OFF to be displayed and the corresponding lamp to turn off.

-----  
OUTPUT TEST

COIN INHIBIT	[ INHIBIT ]	( INHIBIT,ACCEPT )
DIVIDER	[ HOPPER ]	( CASHBOX,HOPPER )
PAYOUT SW LAMP	[ OFF ]	( ON )
COIN IN LAMP	[ OFF ]	( ON )
REFILL METER LAMP	[ OFF ]	( ON )

EXIT

SELECT WITH SERVICE BUTTON  
AND PRESS TEST BUTTON

-----  
Note: The PAYOUT SW LAMP option will not be displayed when set to POUND, DOLLAR, EURO, or ANY CASH.

Selecting the lamp and pressing the TEST Button will turn it from OFF to ON.

### 8.2.4.3.COIN TEST SCREEN

Select COIN TEST to display the following screen and view the Hopper status.

<For POUND Setting>

-----  
COIN TEST

- HOPPER -

HOPPER OUT LAP = 0

HOPPER OUT TOTAL = 0

- HOPPER COUNT SWITCH -

MAX ACTIVE TIME = 0 [msec]

MIN ACTIVE TIME = 0 [msec]

ERROR COUNT = 0

- COIN IN COUNT -

COIN 0.05 = 0

COIN 0.10 = 0

COIN 0.20 = 0

COIN 0.50(N) = 0

COIN 0.50(O) = 0

COIN 1.00 = 0

COIN 2.00 = 0

TOKEN = 0

PAY 1 COIN [ STOP ]

DIVERT TO [ CASHBOX ] ( CASHBOX, HOPPER )

COIN IN [ ACCEPT ] ( INHIBIT, ACCEPT )

EXIT

SELECT WITH SERVICE BUTTON  
AND PRESS TEST BUTTON  
-----

<For DOLLAR, EURO, or ANY CASH Settings>

-----  
COIN TEST

- HOPPER -

HOPPER OUT LAP = 0  
HOPPER OUT TOTAL = 0

- HOPPER COUNT SWITCH -

MAX ACTIVE TIME = 0 [msec]  
MIN ACTIVE TIME = 0 [msec]  
ERROR COUNT = 0

- COIN IN COUNT -

COIN 0.05 = 0  
COIN 0.10 = 0  
COIN 0.20 = 0  
COIN 0.25 = 0  
COIN 0.50 = 0  
COIN 1.00 = 0  
COIN 2.00 = 0  
TOKEN = 0

PAY 1 COIN [ STOP ]  
DIVERT TO [ CASHBOX ] ( CASHBOX, HOPPER )  
COIN IN [ ACCEPT ] ( INHIBIT, ACCEPT )

EXIT

SELECT WITH SERVICE BUTTON  
AND PRESS TEST BUTTON  
-----

<For TOKEN Setting>

-----  
COIN TEST

- HOPPER -

HOPPER OUT LAP = 0  
HOPPER OUT TOTAL = 0

- HOPPER COUNT SWITCH -

MAX ACTIVE TIME = 0 [msec]  
MIN ACTIVE TIME = 0 [msec]  
ERROR COUNT = 0

- COIN IN COUNT -

TOKEN = 0

PAY 1 COIN [ STOP ]  
DIVERT TO [ CASHBOX ] ( CASHBOX, HOPPER )  
COIN IN [ ACCEPT ] ( INHIBIT, ACCEPT )

EXIT

SELECT WITH SERVICE BUTTON  
AND PRESS TEST BUTTON  
-----



**HOPPER OUT LAP:** Number of coins paid out for the current test.

**HOPPER OUT TOTAL:** Total number of coins paid out.

**MAX ACTIVE TIME:** Longest Hopper Switch activity period.

**MIN ACTIVE TIME:** Shortest Hopper Switch activity period.

**ERROR COUNT:** Number of errors encountered.

**COIN COUNT:** Number of coins inserted. When set to DOLLAR, EURO, or ANY CASH, the COIN ASSIGNMENTS setting display will change.

**PAY 1 COIN:** Pays out a single coin.

**DIVERT TO:** Tests sorting of inserted coins.

**COIN IN:** Confirms receipt of inserted coins.

#### 8.2.4.4.TROUBLE LOG SCREEN

Select TROUBLE LOG to display the following screen and show error data/status.

-----  
TROUBLE LOG (1/2)

NO ERROR

PRESS TEST BUTTON FOR NEXT PAGE  
-----

-----  
TROUBLE LOG (2/2)

#002= 0	#101= 0
#003= 0	#102= 0
#004= 0	#103= 0
#005= 0	#104= 0
	#105= 0
	#106= 0
#202= 0	#302= 0
#203= 0	#303= 0
	#304= 0

PRESS TEST BUTTON TO EXIT  
-----

<b>#002 [LOW BATTERY]:</b>	Backup battery voltage has declined significantly. The system will reset, but backup data may be lost. Replace the lithium battery on the I/O board.
<b>#003 [ROM HAS CHANGED]:</b>	The ROM detected is that of an unfamiliar version. If there is a version incompatibility, all backup data will be cleared.
<b>#004 [RAM DATA IS BAD]:</b>	Backup RAM data is abnormal. All backup data will be cleared.
<b>#005 [I/O ERROR]:</b>	There is a problem with the Key Switch. Please inspect the Key Switch.
<b>#101 [COIN IN JAM (HOPPER)]:</b>	Either coin passage time (in Hopper) has been exceeded, or there is a coin jam. Please inspect the coin sensor.
<b>#102 [COIN IN JAM (GAME)]:</b>	Either coin passage time (in game machine) has been exceeded, or there is a coin jam. Please inspect the coin sensor.
<b>#103 [HOPPER OVER PAID]:</b>	Hopper has paid out more than the appropriate number of coins. Please inspect the Hopper.
<b>#104 [HOPPER RUNAWAY]:</b>	Hopper has malfunctioned. Please inspect the Hopper.
<b>#105 [HOPPER EMPTY/JAM]:</b>	No coins have been released from the Hopper within the set time. If the Hopper is empty replenish the coin stock. Otherwise, it is possible that there is a Hopper malfunction.
<b>#106 [HOPPER SENSOR IS BAD]:</b>	The Hopper sensor is not functioning correctly. Please inspect the Hopper.
<b>#202 [COM TIME OUT (DATAPORT)]:</b>	There was no response from the DATAPORT within the set time. The possible problems are that either the DATAPORT is not connected, the DATAPORT is damaged, or that there is some problem within the network.
<b>#203 [COM ERROR (DATAPORT)]:</b>	There is a problem with the DATAPORT response. It is possible that there is a problem with the network.
<b>#302 [COUNTER OUT OF ORDER (IN)]:</b>	The electronic IN counter is broken, or not properly connected.
<b>#303 [COUNTER OUT OF ORDER (OUT)]:</b>	The electronic OUT counter is broken, or not properly connected.
<b>#304 [COUNTER OUT OF ORDER (REFILL)]:</b>	The electronic REFILL counter is broken, or not properly connected.

### 8.2.4.5.MEMORY SETTING

Select MEMORY SETTING to display the following screen and adjust the Hopper Board settings.

-----  
MEMORY SETTING

SHOW HOPPER FLOAT            [ OFF ] ( ON )  
SHOW LAST WIN                [ OFF ] ( ON )  
MAX HOPPER FLOAT            [ 200 ] ( 50, 60, 70 ,,, 200 )

DEFAULT SETTING  
EXIT

SELECT WITH SERVICE BUTTON  
AND PRESS TEST BUTTON  
-----

**SHOW HOPPER FLOAT:**            Determines whether or not to display the HOPPER FLOAT.  
**SHOW LAST WIN:**                Determines whether or not to display the LAST WIN.  
**MAX HOPPER FLOAT:**            Changes the number of coins filled into the Hopper when pressing the HOPPER TOP UP Switch. This option will not be displayed when set to POUND.

### 8.2.4.6.DATAPORT SETTING

Select DATAPORT SETTING to display the following screen and adjust the DATAPORT settings.

-----  
DATAPORT SETTING

OPTION            [ NON-PROT ] ( PROTOCOL, NON-PROT )  
CONDITION        [ TEMP ]        ( TEMP, FOREVER )

EXIT

SELECT WITH SERVICE BUTTON  
AND PRESS TEST BUTTON  
-----

**OPTION:**            Determines whether or not to connect to the DATAPORT.  
**CONDITION:**        DATAPORT Mode status setting.

### 8.2.4.7.COIN ASSIGNMENTS SETTING

Select COIN ASSIGNMENTS to display the following screen and adjust the coin value assignments.

<For DOLLAR, EURO, or ANY CASH Settings>

-----  
COIN ASSIGNMENTS

SETUP COIN VALUE ASSIGNMENTS  
FOR COIN MECH.

COIN #1(PAYOUT COIN) [ 1.00 ] ( 0.05,0.10,0.20,0.25,0.50,1.00,2.00,5.00,10.00 )  
COIN #2 [ 0.25 ] ( 0.05,0.10,0.20,0.25,0.50,1.00,2.00,5.00,10.00 )  
COIN #3 [ 0.20 ] ( 0.05,0.10,0.20,0.25,0.50,1.00,2.00,5.00,10.00 )  
COIN #4 [ 0.10 ] ( 0.05,0.10,0.20,0.25,0.50,1.00,2.00,5.00,10.00 )  
COIN #5(TOKEN) [ 1.00 ] ( 0.05,0.10,0.20,0.25,0.50,1.00,2.00,5.00,10.00 )  
COIN #6 [ 2.00 ] ( 0.05,0.10,0.20,0.25,0.50,1.00,2.00,5.00,10.00 )  
COIN #7 [ 0.05 ] ( 0.05,0.10,0.20,0.25,0.50,1.00,2.00,5.00,10.00 )  
COIN #8 [ 0.50 ] ( 0.05,0.10,0.20,0.25,0.50,1.00,2.00,5.00,10.00 )

DEFAULT SETTING  
EXIT

SELECT WITH SERVICE BUTTON  
AND PRESS TEST BUTTON

-----  
COIN #1 to #8: Coin value assignment number label for each type of coin.

<For TOKEN Setting>

-----  
COIN ASSIGNMENTS

SETUP COIN VALUE ASSIGNMENTS  
FOR COIN MECH.

CREDIT VALUE OF 1 COIN [ 1 ] ( 1, 2, 3, 4, 5, 10, 20, 25, 50, 100 )

DEFAULT SETTING  
EXIT

SELECT WITH SERVICE BUTTON  
AND PRESS TEST BUTTON

-----  
CREDIT VALUE OF 1 COIN: Value assignment for a single coin.

## 8.2.5. CREDIT SETTING

Select CREDIT SETTING to display the following screen and adjust payout (Hopper) related settings.

<For POUND, DOLLAR, EURO, or ANY CASH Settings>

-----  
CREDIT SETTING

FREE PLAY [ OFF ] ( ON, OFF )  
BET [ 1.0 ] (0.5, 1.0)  
MAX PAY [ 100 ] (5, 10, 15,,95, 100)

DEFAULT SETTING

EXIT

SELECT WITH SERVICE BUTTON  
AND PRESS TEST BUTTON

-----  
FREE PLAY: Turns Free Play ON or OFF. Setting to ON allows play without the use of coins.  
BET: Number of coins required for a single play.  
MAX PAY: Maximum payout value. This will not be displayed when set to POUND.

<For TOKEN and BET BUTTON [USED] Setting>

-----  
CREDIT SETTING

FREE PLAY [ OFF ] ( ON, OFF )  
BET BUTTON [ USED ] ( USED, NOT USED )  
MIN BET [ 1 ] ( 1, 2, 3, ..., 100 )  
MAX BET [ 100 ] ( 1, 2, 3, ..., 100 )  
ADD BET [ 1 ] ( 1, 2, 3, ..., 100 )  
AUTOMATIC PAYOUT [ OFF ] ( ON, OFF )  
MAX PAY [ 19999 ] ( 499, 999, 1499, 1999, ... 19999 )  
MAX CREDIT [ 19999 ] ( 499, 999, 1499, 1999, ...19999 )  
HOPPER SIZE [ 399 ] ( 19, 39, 59, 79, ... 399 )

DEFAULT SETTING

EXIT

SELECT WITH SERVICE BUTTON  
AND PRESS TEST BUTTON

<For TOKEN and BET BUTTON [NOT USED] Setting>

-----  
CREDIT SETTING

FREE PLAY	[ OFF ]	( ON, OFF )
BET BUTTON	[ NOT USED ]	( USED, NOT USED )
BET	[ 1 ]	( 1, 2, 3, ..., 100 )
AUTOMATIC PAYOUT	[ OFF ]	( ON,OFF )
MAX PAY	[ 19999 ]	( 499, 999, 1499, 1999, ...19999 )
MAX CREDIT	[ 19999 ]	( 499, 999, 1499, 1999, ...19999 )
HOPPER SIZE	[ 399 ]	( 19, 39, 59, 79, ...399 )

DEFAULT SETTING

EXIT

SELECT WITH SERVICE BUTTON  
AND PRESS TEST BUTTON

-----

<b>FREE PLAY:</b>	Turns Free Play ON or OFF. Setting to ON allows play without the use of coins.
<b>BET BUTTON:</b>	Turns use of BET Button ON or OFF. This will not be displayed when set to POUND, DOLLAR, EURO, or ANY CASH.
<b>MIN BET:</b>	Minimum bet allowed to start a game. (When BET BUTTON is set to USED)
<b>MAX BET:</b>	Maximum bet allowed to start a game. (When BET BUTTON is set to USED)
<b>ADD BET:</b>	Additional bet amount. (When BET BUTTON is set to USED)
<b>BET:</b>	Number of coins required to start a game. (When BET BUTTON is set to NOT USED)
<b>AUTOMATIC PAYOUT:</b>	Switches whether coins are paid out, or added to the player's credits.
<b>MAX PAY:</b>	Maximum number of coins that can be paid out.
<b>MAX CREDIT:</b>	Maximum number of credits.
<b>HOPPER SIZE:</b>	Payout exceeding this value requires payout from attendant.

## 8.2.6. VOLUME SETTING

Select VOLUME SETTING to display the following screen and adjust the control settings for the steering, accelerator, and brake.

VOLUME SETTING Screen

```
-----  
VOLUME SETTING  
  
      MIN      MID      MAX  
[2000]      2000  
STEER: *-----  
  
[2000]3000      C000  
ACCEL:---*-----*-----  
  
[8100]3000      C000  
BRAKE:---*-----*-----
```

-> EXIT

SELECT WITH SERVICE BUTTON  
AND PRESS TEST BUTTON

-----  
Use the SERVICE Button to move the cursor to the desired test item. Press the TEST Button to enter any of the items, and set as explained below.

### **STEER**

Press the START Button when the steering wheel is directly in the centre.

### **ACCEL**

Press the START Button with the accelerator pedal released, then after pressing the accelerator pedal all the way down, press the START Button again.

### **BRAKE**

Press the START Button with the brake pedal released, then after pressing the brake pedal all the way down, press the START Button again.

After making changes, be sure to select EXIT and press the TEST Button in order to enable the new settings. After changing the settings, select EXIT and press the TEST Button to return to the Game Test Menu screen.

## 8.2.7. BOOKKEEPING SCREEN

Select BOOKKEEPING to display the following screen and view up-to-date operational game data. There are four total BOOKKEEPING screens when CURRENCY is set to a monetary currency, such as POUND, and nine total screens when set to TOKEN.

## 8.2.7.1.BOOKKEEPING FOR POUND, DOLLAR, EURO, OR ANY CASH SETTINGS

BOOKKEEPING 1/4 Screen

-----  
BOOKKEEPING 1/4

NUMBER OF GAMES	0
PLAY TIME	0D 0H 0M 0S
AVERAGE PLAY TIME	0H 0M 0S
LONGEST PLAY TIME	0H 0M 0S
SHORTEST PLAY TIME	0H 0M 0S

PRESS TEST BUTTON TO CONTINUE  
-----

**NUMBER OF GAMES:** Total number of games played.  
**PLAY TIME:** Total in-game play time.  
**AVERAGE PLAY TIME:** Total play time divided by the number of individual games played.  
**LONGEST PLAY TIME:** Longest of all games played.  
**SHORTEST PLAY TIME:** Shortest of all games played.

Pressing the TEST Button will bring up the following screen.

BOOKKEEPING 2/4 Screen

-----  
BOOKKEEPING 2/4

TIME HISTOGRAM	
0M00S - 0M29S	0
0M30S - 0M59S	0
1M00S - 1M29S	0
1M30S - 1M59S	0
2M00S - 2M29S	0
2M30S - 2M59S	0
3M00S - 3M29S	0
3M30S - 3M59S	0
4M00S - 4M29S	0
4M30S - 4M59S	0
OVER 5M00S	0

PRESS TEST BUTTON TO CONTINUE  
-----

PLAY TIME HISTOGRAM shows the number of plays and the respective play times. This histogram should be referred to when setting the game difficulty.



Pressing the TEST Button will bring up the following screen.

<For POUND Setting>

BOOKKEEPING 3/4 Screen

-----  
BOOKKEEPING 3/4

COIN IN ( 0.05) = 0  
COIN IN ( 0.10) = 0  
COIN IN ( 0.20) = 0  
COIN IN ( 0.50) = 0  
COIN IN ( 1.00) = 0  
COIN IN ( 2.00) = 0

CASH IN = 0.00  
CASH OUT = 0.00  
ATTENDANT OUT = 0.00  
SERVICE CREDITS = 0.00

PRESS TEST BUTTON TO CONTINUE

-----

- COIN IN:** Number of individual coins inserted.
- CASH IN:** Total monetary value inserted.
- CASH OUT:** Total monetary value paid out from the Hopper.
- ATTENDANT OUT:** Number of coins paid out by the attendant.
- SERVICE CREDITS:** Number of credits added with the SERVICE Button.

Pressing the TEST Button will bring up the following screen.

<For DOLLAR, EURO, or ANY CASH Settings>

BOOKKEEPING 3/4 Screen

-----  
BOOKKEEPING 3/4

COIN IN ( 0.05) = 0  
COIN IN ( 0.10) = 0  
COIN IN ( 0.20) = 0  
COIN IN ( 0.25) = 0  
COIN IN ( 0.50) = 0  
COIN IN ( 1.00) = 0  
COIN IN ( 2.00) = 0  
TOKEN IN ( 1.00) = 0

TOTAL IN VALUE = 0.00  
TOTAL OUT VALUE = 0.00  
ATTENDANT OUT = 0.00  
SERVICE CREDITS = 0.00

PRESS TEST BUTTON TO CONTINUE

-----

**COIN IN:** Number of individual coins inserted. This number will differ in the COIN ASSIGNMENTS setting.

**TOKEN IN:** Number of tokens inserted. This number will not be displayed when CURRENCY is set to POUND.

**TOTAL IN VALUE:** Total value of inserted coins.

**TOTAL OUT VALUE:** Total value paid out from the Hopper.

**ATTENDANT OUT:** Number of coins paid out by the attendant.

**SERVICE CREDITS:** Number of credits added with the SERVICE Button.

Pressing the TEST Button will bring up the following screen.

BOOKKEEPING 4/4 Screen

-----  
 BOOKKEEPING 4/4

SETTINGS: DOSH DASH RACE:  
 PAYOUT: 90% WINS / GAMES (WIN%)  
 BEGINNER : 0 / 0 (0.0%)  
 TOTAL: INTERMEDIATE: 0 / 0 (0.0%)  
 BET: EXPER: 0 / 0 (0.0%)  
 WIN: WINMAX WINAVG TTLAVG  
 BEGINNER: 0 0.0 0.0  
 D\_D RACE: INTERMEDIATE: 0 0.0 0.0  
 BET: EXPERT: 0 0.0  
 WIN:  
 P/O DOUBLE UP CHALLENGE:  
 GAMES: 0  
 DOUBLE UP: DONE: 0.00%  
 BET: MAX: 0  
 WIN: WIN.R: 0.00%  
 P/O: [ 0] 0  
 [ 1] 0  
 CONTINUE: [ 2] 0  
 BET: [ 3] 0  
 WIN: [ 4] 0  
 P/O: [ 5] 0  
 [ 6] 0  
 [ 7] 0  
 [ 8] 0  
 [ 9] 0  
 [10] 0  
 [11] 0

CONTINUE:  
 TRY: 0 / 0 (0.00%)  
 WIN: 0 / 0 (0.00%)

PRESS TEST BUTTON TO EXIT  
 -----

**SETTINGS:**

PAYOUT: Payout ratio setting.

**TOTAL:**

BET: Total number of bets made.

WIN: Total number of wins.

P/O: Resulting actual, total payout ratio.

**D\_D RACE:**

BET: Number of DOSH DASH RACE bets made.

WIN: Number of DOSH DASH RACE wins.

P/O: Resulting, actual DOSH DASH RACE payout ratio.

**DOUBLE UP:**

BET: Number of DOUBLE UP CHALLENGE bets made.

WIN: Number of DOUBLE UP CHALLENGE wins.

P/O: Resulting, actual DOUBLE UP CHALLENGE payout ratio.

**CONTINUE**

BET: Number of CONTINUE bets made.

WIN: Number of CONTINUE wins.

P/O: Resulting, actual CONTINUE payout ratio.

**DOSH DASH RACE:**

	WINS	/	GAMES	(WIN %)
BEGINNER:	0	/	0	(0.0%)
INTERMEDIATE:	0	/	0	(0.0%)
EXPERT:	0	/	0	(0.0%)

The number of games played, number of wins, and the win ratio will be displayed for each difficulty setting.

	WINMAX	WINAVG	TTLAVG
BEGINNER:	0	0.0	0.0
INTERMEDIATE	0	0.0	0.0
:			
EXPERT:	0	0.0	

Here, the maximum number of wins and the average number of wins will be displayed for each difficulty setting. The TTLAVG is a total average of all DOSH DASH RACE coins paid out.

**DOUBLE UP CHALLENGE**

GAMES: Number of DOUBLE UP games played.

DONE: DOUBLE UP play ratio.

MAX: Maximum number of DOUBLE UP wins.

WIN.R: DOUBLE UP win ratio.

- [ 0] Failure on try number 1.
- [ 1] Success on try number 1, or failure on try number 2.
- [ 2] Success on try number 2, or failure on try number 3.
- [ 3] Success on try number 3, or failure on try number 4.
- [ 4] Success on try number 4, or failure on try number 5.
- [ 5] Success on try number 5, or failure on try number 6.
- [ 6] Success on try number 6, or failure on try number 7.
- [ 7] Success on try number 7, or failure on try number 8.
- [ 8] Success on try number 8, or failure on try number 9.
- [ 9] Success on try number 9, or failure on try number 10.
- [10] Success on try number 10, or failure on try number 11.
- [11] Success on try number 11.

**CONTINUE:**

TRY: The ratio of CONTINUE games tried to games tried. (CONTINUE number / games tried)

WIN: The ratio of successful tries (WINS) to games tried. (WINS / games tried)

Press the TEST Button to return to the Game Test Menu screen.

**8.2.7.2.BOOKKEEPING FOR TOKEN SETTING**

Page 1/9, 2/9, and 4/9 are identical to the " BOOKKEEPING for POUND, DOLLAR, EURO, or ANY CASH setting" above.

BOOKKEEPING 3/9 Screen

-----  
BOOKKEEPING 3/9

COIN IN = 0

COIN OUT = 0

ATTENDANT OUT = 0

PRESS TEST BUTTON TO CONTINUE  
-----

**COIN IN:** Total number of inserted coins.

**COIN OUT:** Total number of coins paid out.

**ATTENDANT OUT:** Total number of coins paid out by attendant.

Pressing the TEST Button will bring up the following screen.

BOOKKEEPING 5/9 Screen

-----  
BOOKKEEPING 5/9

BET	WIN/BET	PAYOUT	GOOD/GAMES	GOOD%
1:	0/0	0.0%	0/0	0.0%
2:	0/0	0.0%	0/0	0.0%
3:	0/0	0.0%	0/0	0.0%
4:	0/0	0.0%	0/0	0.0%
5:	0/0	0.0%	0/0	0.0%
6:	0/0	0.0%	0/0	0.0%
7:	0/0	0.0%	0/0	0.0%
8:	0/0	0.0%	0/0	0.0%
9:	0/0	0.0%	0/0	0.0%
10:	0/0	0.0%	0/0	0.0%
11:	0/0	0.0%	0/0	0.0%
12:	0/0	0.0%	0/0	0.0%
13:	0/0	0.0%	0/0	0.0%
14:	0/0	0.0%	0/0	0.0%
15:	0/0	0.0%	0/0	0.0%
16:	0/0	0.0%	0/0	0.0%
17:	0/0	0.0%	0/0	0.0%
18:	0/0	0.0%	0/0	0.0%
19:	0/0	0.0%	0/0	0.0%
20:	0/0	0.0%	0/0	0.0%
21:	0/0	0.0%	0/0	0.0%
22:	0/0	0.0%	0/0	0.0%
23:	0/0	0.0%	0/0	0.0%
24:	0/0	0.0%	0/0	0.0%
25:	0/0	0.0%	0/0	0.0%

PRESS TEST BUTTON TO CONTINUE

-----  
The size of bets made (1 – 25 coins), number of wins, actual payout ratio, number of successful games, number of games played, and rate of success will be displayed.

Pressing the TEST Button will bring up the following screen.

BOOKKEEPING 6/9 Screen

-----  
BOOKKEEPING 6/9

BET	WIN/BET	PAYOUT	GOOD/GAMES	GOOD%
26:	0/0	0.0%	0/0	0.0%
27:	0/0	0.0%	0/0	0.0%
28:	0/0	0.0%	0/0	0.0%
29:	0/0	0.0%	0/0	0.0%
30:	0/0	0.0%	0/0	0.0%
31:	0/0	0.0%	0/0	0.0%
32:	0/0	0.0%	0/0	0.0%
33:	0/0	0.0%	0/0	0.0%
34:	0/0	0.0%	0/0	0.0%
35:	0/0	0.0%	0/0	0.0%
36:	0/0	0.0%	0/0	0.0%
37:	0/0	0.0%	0/0	0.0%
38:	0/0	0.0%	0/0	0.0%
39:	0/0	0.0%	0/0	0.0%
40:	0/0	0.0%	0/0	0.0%
41:	0/0	0.0%	0/0	0.0%
42:	0/0	0.0%	0/0	0.0%
43:	0/0	0.0%	0/0	0.0%
44:	0/0	0.0%	0/0	0.0%
45:	0/0	0.0%	0/0	0.0%
46:	0/0	0.0%	0/0	0.0%
47:	0/0	0.0%	0/0	0.0%
48:	0/0	0.0%	0/0	0.0%
49:	0/0	0.0%	0/0	0.0%
50:	0/0	0.0%	0/0	0.0%

PRESS TEST BUTTON TO CONTINUE

-----  
The size of bets made (26 – 50 coins), number of wins, actual payout ratio, number of successful games, number of games played, and rate of success will be displayed.

Pressing the TEST Button will bring up the following screen.

BOOKKEEPING 7/9 Screen

-----  
BOOKKEEPING 7/9

BET	WIN/BET	PAYOUT	GOOD/GAMES	GOOD%
51:	0/0	0.0%	0/0	0.0%
52:	0/0	0.0%	0/0	0.0%
53:	0/0	0.0%	0/0	0.0%
54:	0/0	0.0%	0/0	0.0%
55:	0/0	0.0%	0/0	0.0%
56:	0/0	0.0%	0/0	0.0%
57:	0/0	0.0%	0/0	0.0%
58:	0/0	0.0%	0/0	0.0%
59:	0/0	0.0%	0/0	0.0%
60:	0/0	0.0%	0/0	0.0%
61:	0/0	0.0%	0/0	0.0%
62:	0/0	0.0%	0/0	0.0%
63:	0/0	0.0%	0/0	0.0%
64:	0/0	0.0%	0/0	0.0%
65:	0/0	0.0%	0/0	0.0%
66:	0/0	0.0%	0/0	0.0%
67:	0/0	0.0%	0/0	0.0%
68:	0/0	0.0%	0/0	0.0%
69:	0/0	0.0%	0/0	0.0%
70:	0/0	0.0%	0/0	0.0%
71:	0/0	0.0%	0/0	0.0%
72:	0/0	0.0%	0/0	0.0%
73:	0/0	0.0%	0/0	0.0%
74:	0/0	0.0%	0/0	0.0%
75:	0/0	0.0%	0/0	0.0%

PRESS TEST BUTTON TO CONTINUE

-----  
The size of bets made (51 – 75 coins), number of wins, actual payout ratio, number of successful games, number of games played, and rate of success will be displayed.

Pressing the TEST Button will bring up the following screen.

BOOKKEEPING 8/9 Screen

-----  
BOOKKEEPING 8/9

BET	WIN/BET	PAYOUT	GOOD/GAMES	GOOD%
76:	0/0	0.0%	0/0	0.0%
77:	0/0	0.0%	0/0	0.0%
78:	0/0	0.0%	0/0	0.0%
79:	0/0	0.0%	0/0	0.0%
80:	0/0	0.0%	0/0	0.0%
81:	0/0	0.0%	0/0	0.0%
82:	0/0	0.0%	0/0	0.0%
83:	0/0	0.0%	0/0	0.0%
84:	0/0	0.0%	0/0	0.0%
85:	0/0	0.0%	0/0	0.0%
86:	0/0	0.0%	0/0	0.0%
87:	0/0	0.0%	0/0	0.0%
88:	0/0	0.0%	0/0	0.0%
89:	0/0	0.0%	0/0	0.0%
90:	0/0	0.0%	0/0	0.0%
91:	0/0	0.0%	0/0	0.0%
92:	0/0	0.0%	0/0	0.0%
93:	0/0	0.0%	0/0	0.0%
94:	0/0	0.0%	0/0	0.0%
95:	0/0	0.0%	0/0	0.0%
96:	0/0	0.0%	0/0	0.0%
97:	0/0	0.0%	0/0	0.0%
98:	0/0	0.0%	0/0	0.0%
99:	0/0	0.0%	0/0	0.0%
100:	0/0	0.0%	0/0	0.0%

PRESS TEST BUTTON TO CONTINUE

-----  
The size of bets made (76 – 100 coins), number of wins, actual payout ratio, number of successful games, number of games played, and rate of success will be displayed.



Pressing the TEST Button will bring up the following screen.

BOOKKEEPING 9/9 Screen

-----  
BOOKKEEPING 9/9

ITEM	WIN/LOSE	WIN/LOSE
TREASURE +10	0/0	-/-
TREASURE +20	0/0	-/-
TREASURE +30	0/0	-/-
TREASURE +50	0/0	-/-
TREASURE +100	0/0	-/-
TREASURE x2	0/0	-/-
TREASURE x3	0/0	-/-
TREASURE x4	0/0	-/-
TREASURE x5	0/0	-/-
SHIELD x1	0/0	-/-
SHIELD x2	0/0	-/-
SHIELD x3	0/0	-/-
SHIELD x4	0/0	-/-
TIME SLOW	0/0	-/-
TIME_B x2	0/0	-/-
WEATHERCOCK	0/0	0/0
PREMIUM	0/0	-/-
FAIRY	0/0	-/-
B_ZONE x2	0/0	0/0
SPY GLASS	0/0	0/0

PRESS TEST BUTTON TO EXIT  
-----

When CURRENCY is set to TOKEN in the GAME SETTING and ITEM FEATURE is set to ON, the number of items won/lost in normal games, as well as the number of items won/lost when using CONTINUE, is shown.

Note: These figures will not be displayed when ITEM FEATURE is set to OFF.

Press the TEST Button to return to the Game Test Menu screen.

### 8.2.8. BACKUP DATA CLEAR SCREEN

Select BACKUP DATA CLEAR to clear the contents of BOOKKEEPING.

Note that this operation does not affect the settings for GAME SETTING.

BACKUP DATA CLEAR Screen

-----  
BACKUP DATA CLEAR

YES (CLEAR)  
-> NO (CANCEL)

SELECT WITH SERVICE BUTTON  
AND PRESS TEST BUTTON

-----  
To clear data, use the SERVICE Button to move the cursor to YES (CLEAR) and then press the TEST Button.

When the data has been cleared, the message "COMPLETED" will be displayed.

Press the TEST Button again to return to the Game Test Menu screen.

Move the cursor to NO (CANCEL) and press the TEST Button to return to the Game Test Menu screen without clearing the data.

## 9. DESIGN RELATED PARTS



ITEM	PART NO,	QTY	DESCRIPTION
1	PUB-5005	1	STICKER CNTRL PNL FRONT
2	PUB-1055UK	1	INSTR PLATE L
3	PUB-1056UK	1	INSTR PLATE R
4	PUB-5001	1	STICKER CABI SIDE L
5	PUB-5002	1	STICKER CABI SIDE R
6	PUB-5003	1	STICKER SIDE COVER L
7	PUB-5004	1	STICKER SIDE COVER R
8	PUB-1056-BUK	1	DECAL COIN ENTRY
9	PUB-2021UK	1	CTRL PNL SH CKT PRIZE
10	PUB-5022-01	1	INSTR SH UPPER CKT PRIZE
11	PUB-5023-01	1	INSTR SH LOWER CKT PRIZE
12	PUB-5008	1	LOGO SH CKT PRIZE
13	PUB-5006	1	POP CASHCUBE
14	PUB-1176	1	EMBLEM PUB

## 10. APPENDIX A - ELECTRICAL SCHEMATIC

### 10.1. WIRE COLOURS

THE WIRE COLOUR CODE IS AS FOLLOWS:

A	PINK
B	SKY BLUE
C	BROWN
D	PURPLE
E	LIGHT GREEN

Wires other than those of any of the colours listed above will be displayed by 2 alphanumeric characters:

1	RED
2	BLUE
3	YELLOW
4	GREEN
5	WHITE
7	ORANGE
8	BLACK
9	GREY

If the right hand side numeral of the code is 0, then the wire will be of a single colour shown by the left hand side numeral (see the list above).

Note 1: If the right hand side alphanumeric is not 0, that particular wire has a spiral colour code. The left hand side character shows the base colour and the right hand side one, the spiral colour.

[Example] 51----- WHITE/RED = WHITE wire with RED stripes

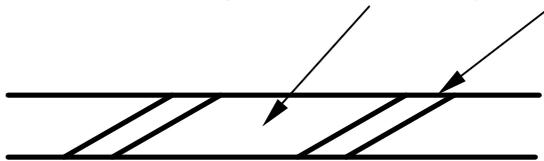

Note 2: The character following the wire colour code indicates the size of the wire.

K:	AWG18, UL1015
L:	AWG20, UL1007
None	AWG22, UL1007

### 10.2. ELECTRICAL SCHEMATIC

The following pages contain the electrical schematic for this machine.

**10.3. SCHEMATIC DRAWING 1**

SCHEMATIC DRAWING 1 HERE

**10.4. SCHEMATIC DRAWING 2**

SCHEMATIC DRAWING 2 HERE

**SEGA AMUSEMENTS EUROPE LTD./ SEGA SERVICE CENTRE**

Suite 3a  
Oaks House  
12 - 22 West Street  
Epsom  
Surrey  
United Kingdom  
KT18 7RG

Telephone: +44 (0) 1372 731820

Fax: +44 (0) 1372 731849

**SEGA<sup>®</sup>**



ã SEGA 2004





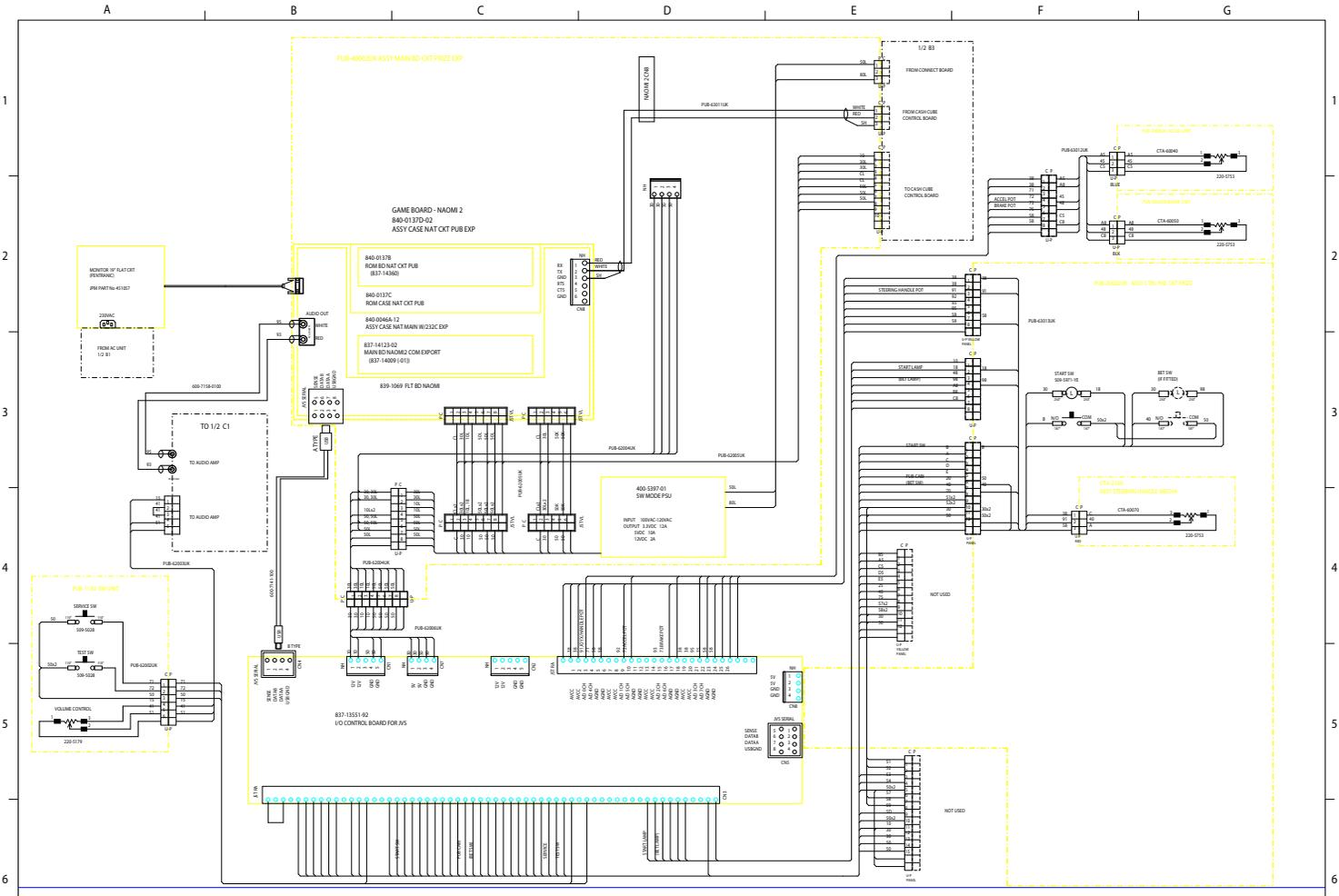

DRAWN		CHECKED		SEGA SEGA ENTERPRISES, LTD.		THIS DRAWING WILL IN NO WAY BE COPIED. TO BE RETURNED ON DEMAND.	
CW				CASH CUBE - KART		SCHEM 2/2	
PUB-00002UK		18/02/94					

ALTERATION	4 BLACK 1 WHITE 5 PURPLE 3 ORANGE 2 YELLOW 1 BLUE 1 RED	5 LIGHT GREEN 3 PURPLE 2 PINK 1 SKY BLUE 1 PINK 1 GREY	13 FANTY WIRE 1 MOBILE SILLIUS 1 MOBILE SILLIUS 1 MOBILE SILLIUS 1 MOBILE SILLIUS 1 MOBILE SILLIUS	DRAWN CHECKED CW 18/02/94	SEGA SEGA ENTERPRISES, LTD. CASH CUBE - KART THIS DRAWING WILL IN NO WAY BE COPIED. TO BE RETURNED ON DEMAND.	SCHEM 2/2
------------	---	---	---	------------------------------------	---	-----------