

SEGA

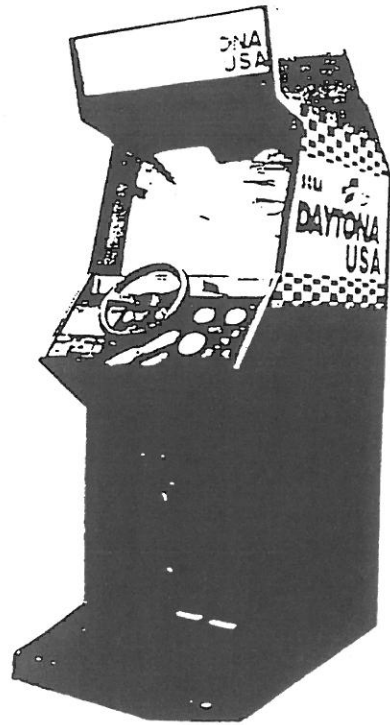

**DAYTONATM
USA**

**UPRIGHT
OWNER'S MANUAL**



SEGA ENTERPRISES, LTD.

PRELIMINARY MANUAL

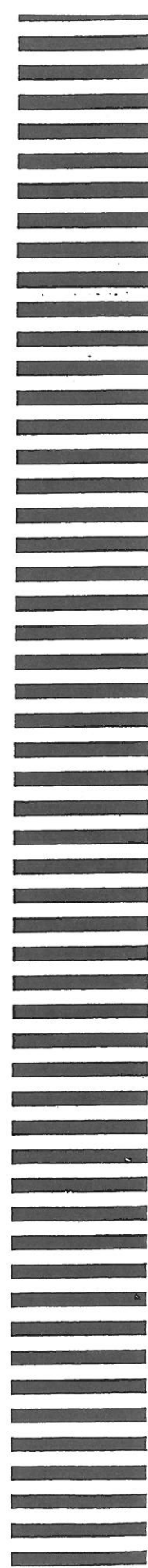

NOTICE

THIS MANUAL IS A PRELIMINARY MANUAL ONLY, AND THE INFORMATION CONTAINED IS TO ASSIST QUALIFIED SERVICE PERSONNEL IN INSTALLING AND SETTING UP THE EQUIPMENT QUICKLY. ANY QUESTIONS RELATING TO DETAILS ON INSTALLATION AND SERVICING NOT COVERED BY THIS MANUAL ARE TO BE DIRECTED TO THE APPROPRIATE SEGA'S DISTRIBUTOR OR TO THE SEGA CUSTOMER SERVICE DEPARTMENT.

Our customers should note that contents of this manual may not accurately described all of the features of the game received. As a result, descriptions in this manual are subject to change without prior notice.

Sega has received a tremendous demand for this game, and we are experiencing a delay in the development of the manual. We apologize for this delay and appreciate your patience and understanding. We will resolve this delay quickly, and we will send the final draft of the manual to you as soon as it becomes available.

1. HANDLING PRECAUTIONS

When installing or inspecting the machine, be very careful of the following points and pay attention to ensure that the player can enjoy the game safely.

- Be sure to turn the power off before working on the machine.
- To insert or pull out the plug quickly is dangerous.
- It is necessary to make sure that the power cord or the grounding wire is not exposed on the road, etc. in a manner so as to be dangerous. Make sure that grounding connections are made safely at the position where so specified.
- Do not use any fuse that does not meet specified rating.
- Make complete connections for the IC board and other connectors. Insufficient insertion is very dangerous.
- The operating (ambient) temperature range is from 5°C to 40°C.
- When cleaning the CRT surfaces, use a soft, dry cloth. Do not apply chemicals such as thinner, benzine, etc.

Also, for the IC board circuit inspections, only the logic tester is allowed. The use of a tester is not permitted, so be careful in this regard.

After confirming that there are no irregularities, turn the power ON.

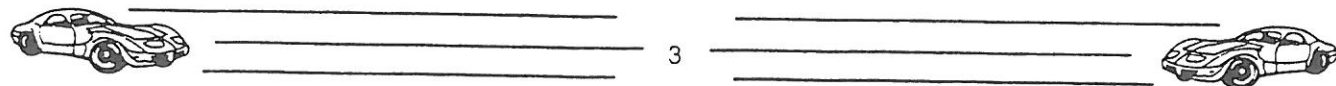
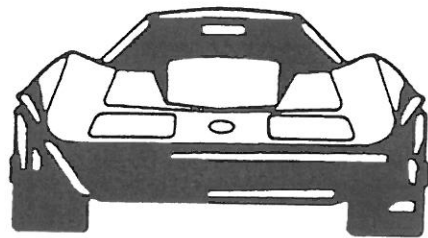

⑤ TURNING THE POWER ON

Turning the AC UNIT's MAIN SW on will cause the machine to start the POWER ON check and NETWORK check automatically.

In the POWER ON check, the steering wheel turns left and right, then returns to the centering position and stops. In this check, the values of V.R. inside the control panel are corrected. Until the check is finished (the steering wheel stops automatically), do not touch the steering wheel or play the game.

If you do, the steering wheel reaction during the game (reaction at the time of a course-out or crashing) can not be obtained correctly.

In a case of a strange reaction during the game, turn the power on again from the beginning and complete the power-on check.

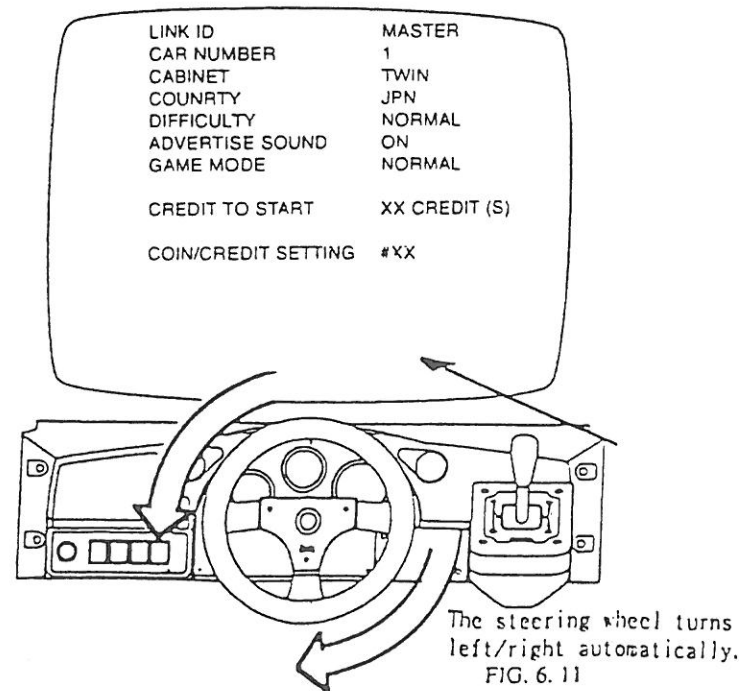

- 8) After the game is started, the allotted time decreases. Passing a check point allows the game to continue with the previous remaining time added to the time limit up to the next check point. If you fail to pass a checkpoint within the time limit, the game will be over.
- 9) In case of a course-out or crash, the steering wheel reacts.
- 10) When you finish 8 laps, 4 laps and 2 laps, which respectively corresponds to the BEGINNER, ADVANCED and EXPERT course, the game will be over. The lap setting can be changed for specific attraction event purposes.
- 11) The player whose results are excellent is allowed to register his name. Turn the steering wheel to choose the alphabetical letters and step on the accelerator to effectuate the selection. The name will be displayed on the DEMO screen.
- 12) In the case you do not play "vs." competition, when choosing AUTO or MANUAL, stepping on the Accelerator while pressing the start button will result in a TIME ATTACK mode in which no competitor car will appear and only the player's car will run.

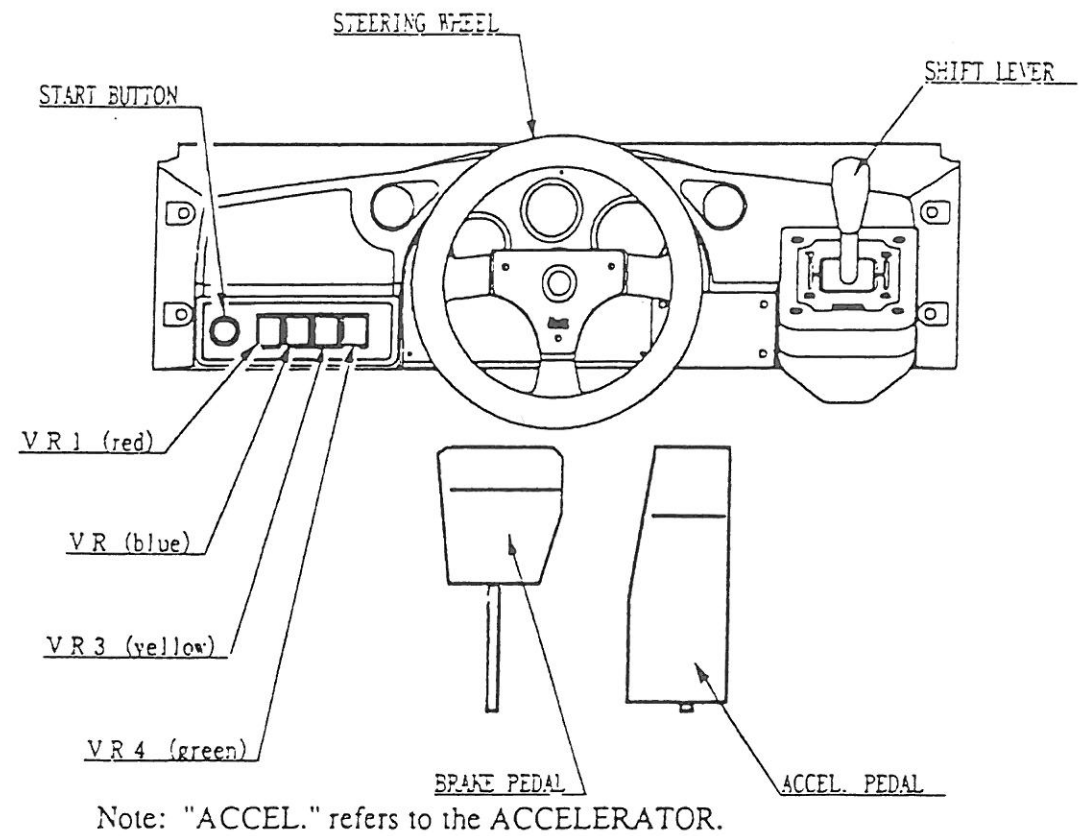

FIG. 7. 2

PLAYING TECHNIQUE

It is recommended that you choose AUTOMATIC if you are not so familiar with the game. Also, note that choosing V.R. SW No. 2 (blue) or No. 3 (yellow) allows for better perspectives. At the corners, be sure to drive slower. Refrain from abruptly turning the steering wheel to avoid an accident. In this game, skillful braking is important. Also, note that it is important to grasp the features of the courses as soon as you can. Find out the best way to pass the corners.

When MANUAL SHIFT is chosen, refer to the engine r.p.m. for shifting. SHIFTING UP immediately before the indicator indicates the red zone allows the acceleration to be made in the most efficient manner.

8-3 BOOKKEEPING

Selecting the BOOKKEEPING in the menu mode causes the bookkeeping data up to the present to be displayed on 2 pages.

- Press the TEST SW or START BUTTON to return to the MENU mode screen.
- Press VR1 (red) to proceed to the other page.

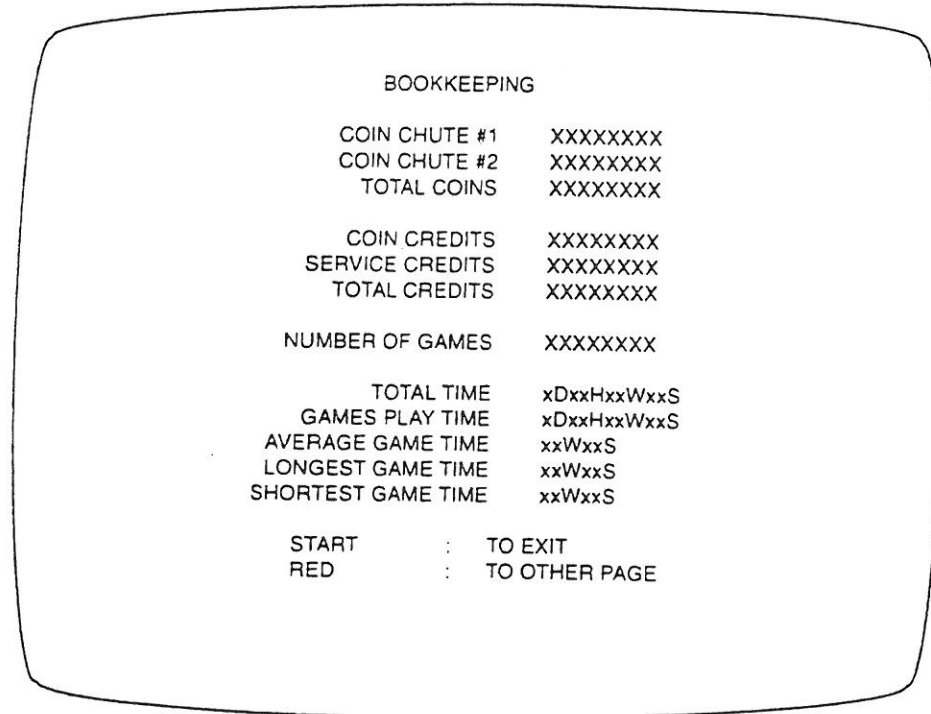

FIG. 8.3a BOOKKEEPING

- COIN CHUTE #*: Number of coins put in. As seen from the front of the cabinet, the right-hand side is #1 and the left-hand side is #2.
- TOTAL COINS: Total number of activations of coin chutes.
- COIN CREDITS: Number of credits registered by inserting coins.
- SERVICE CREDITS: Credits registered by the SERVICE switch.
- TOTAL CREDITS: Total number of credits (COIN CREDITS + SERVICE CREDITS)
- TOTAL TIME: The total energized time.

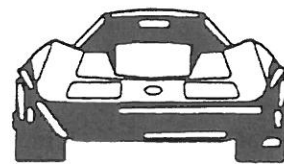

TABLE 8.2 COIN/CREDIT SETTING (COIN CHUTE COMMON TYPE)

NAME OF SETTING	FUNCTIONING OF COIN CHUTE #1		FUNCTIONING OF COIN CHUTE #2	
SETTING #1	1 COIN	1 CREDIT	1 COIN	1 CREDIT
SETTING #2	1 COIN	1 CREDIT	1 COIN	2 CREDITS
SETTING #3	1 COIN	1 CREDIT	1 COIN	3 CREDITS
SETTING #4	1 COIN	1 CREDIT	1 COIN	4 CREDITS
SETTING #5	1 COIN	1 CREDIT	1 COIN	5 CREDITS
SETTING #6	1 COIN	2 CREDITS	1 COIN	2 CREDITS
SETTING #7	1 COIN	2 CREDITS	1 COIN	5 CREDITS
SETTING #8	1 COIN	3 CREDITS	1 COIN	3 CREDITS
SETTING #9	1 COIN	4 CREDITS	1 COIN	4 CREDITS
SETTING #10	1 COIN	5 CREDITS	1 COIN	5 CREDITS
SETTING #11	1 COIN	6 CREDITS	1 COIN	6 CREDITS
SETTING #12	2 COINS	1 CREDIT	2 COINS	1 CREDIT
SETTING #13	2 COINS	1 CREDIT	1 COIN	1 CREDIT
SETTING #14	2 COINS	1 CREDIT	1 COIN	2 CREDITS
SETTING #15	1 COIN	1 CREDIT	1 COIN	1 CREDIT
	2 COINS	3 CREDITS		
SETTING #16	1 COIN	1 CREDIT	1 COIN	3 CREDITS
	2 COINS	3 CREDITS		
SETTING #17	3 COINS	1 CREDIT	3 COINS	1 CREDIT
SETTING #18	4 COINS	1 CREDIT	4 COINS	1 CREDIT
SETTING #19	1 COIN	1 CREDIT	1 COIN	1 CREDIT
	2 COINS	2 CREDITS	2 COINS	2 CREDITS
	3 COINS	3 CREDITS	3 COINS	3 CREDITS
	4 COINS	5 CREDITS	4 COINS	5 CREDITS
SETTING #20	1 COIN	1 CREDIT	1 COIN	5 CREDITS
	2 COINS	2 CREDITS		
	3 COINS	3 CREDITS		
	4 COINS	5 CREDITS		
SETTING #21	5 COINS	1 CREDIT	5 COINS	1 CREDIT
SETTING #22	3 COINS	1 CREDIT	5 COINS	1 CREDIT
	5 COINS	2 CREDITS		
SETTING #23	2 COINS	1 CREDIT	2 COINS	1 CREDIT
	4 COINS	2 CREDITS	4 COINS	2 CREDITS
	5 COINS	3 CREDITS	5 COINS	3 CREDITS
SETTING #24	2 COINS	1 CREDIT	1 COIN	3 CREDITS
	4 COINS	2 CREDITS		
	5 COINS	3 CREDITS		
SETTING #25	1 COIN	1 CREDIT	1 COIN	1 CREDIT
	2 COINS	2 CREDITS	2 COINS	2 CREDITS
	3 COINS	3 CREDITS	3 COINS	3 CREDITS
	4 COINS	4 CREDITS	4 COINS	4 CREDITS
	5 COINS	6 CREDITS	5 COINS	6 CREDITS
SETTING #26	1 COIN	1 CREDIT	1 COIN	6 CREDITS
	2 COINS	2 CREDITS		
	3 COINS	3 CREDITS		
	4 COINS	4 CREDITS		
	5 COINS	6 CREDITS		
SETTING # 27	FREE PLAY		FREE PLAY	



DRAWING NO. 50-8495-05		REV. ZONE		DESCRIPTION		E.C.N. #		BY		DATE	
		A -		INITIAL RELEASE		-		LEE		4/6/95	

1 2 3 4 5

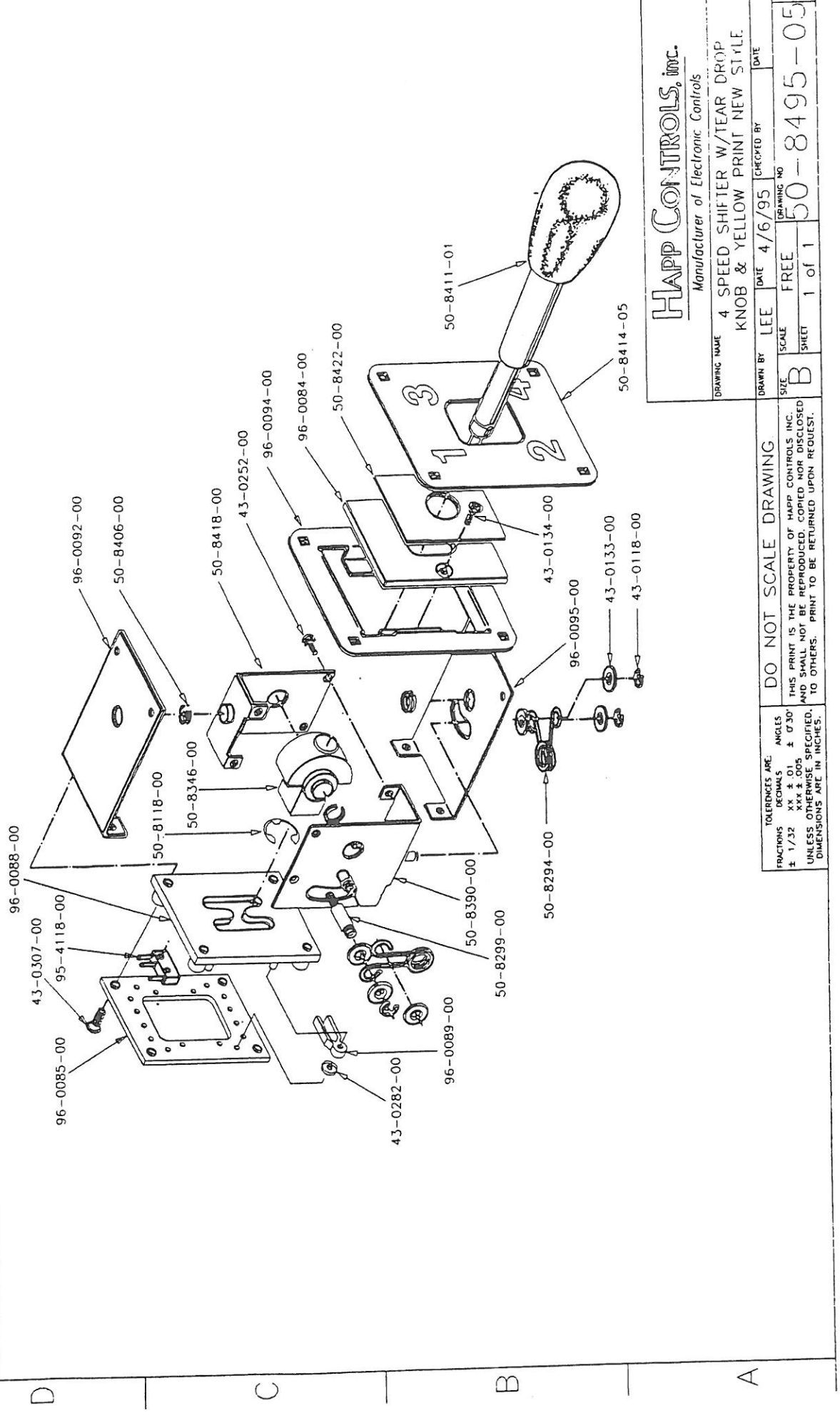

HAPP CONTROLS, inc.
Manufacturer of Electronic Controls

DRAWING NAME: 4 SPEED SHIFTER W/TEAR DROP
KNOB & YELLOW PRINT NEW STYLE.

DRAWN BY	LEE	DATE	4/6/95	CHECKED BY	
SIZE	B	SCALE	FREE	DRAWING NO.	50-8495-05
SHEET	1	OF	1		

DO NOT SCALE DRAWING.
THIS PRINT IS THE PROPERTY OF HAPP CONTROLS, INC. AND SHALL NOT BE REPRODUCED, COPIED, NOR DISCLOSED TO OTHERS. PRINT TO BE RETURNED UPON REQUEST.

TOLERANCES ARE:
FRACTIONS ± 1/32
DECIMALS ± 0.30
XXX ± .005
UNLESS OTHERWISE SPECIFIED,
DIMENSIONS ARE IN INCHES.

A

B

C

D

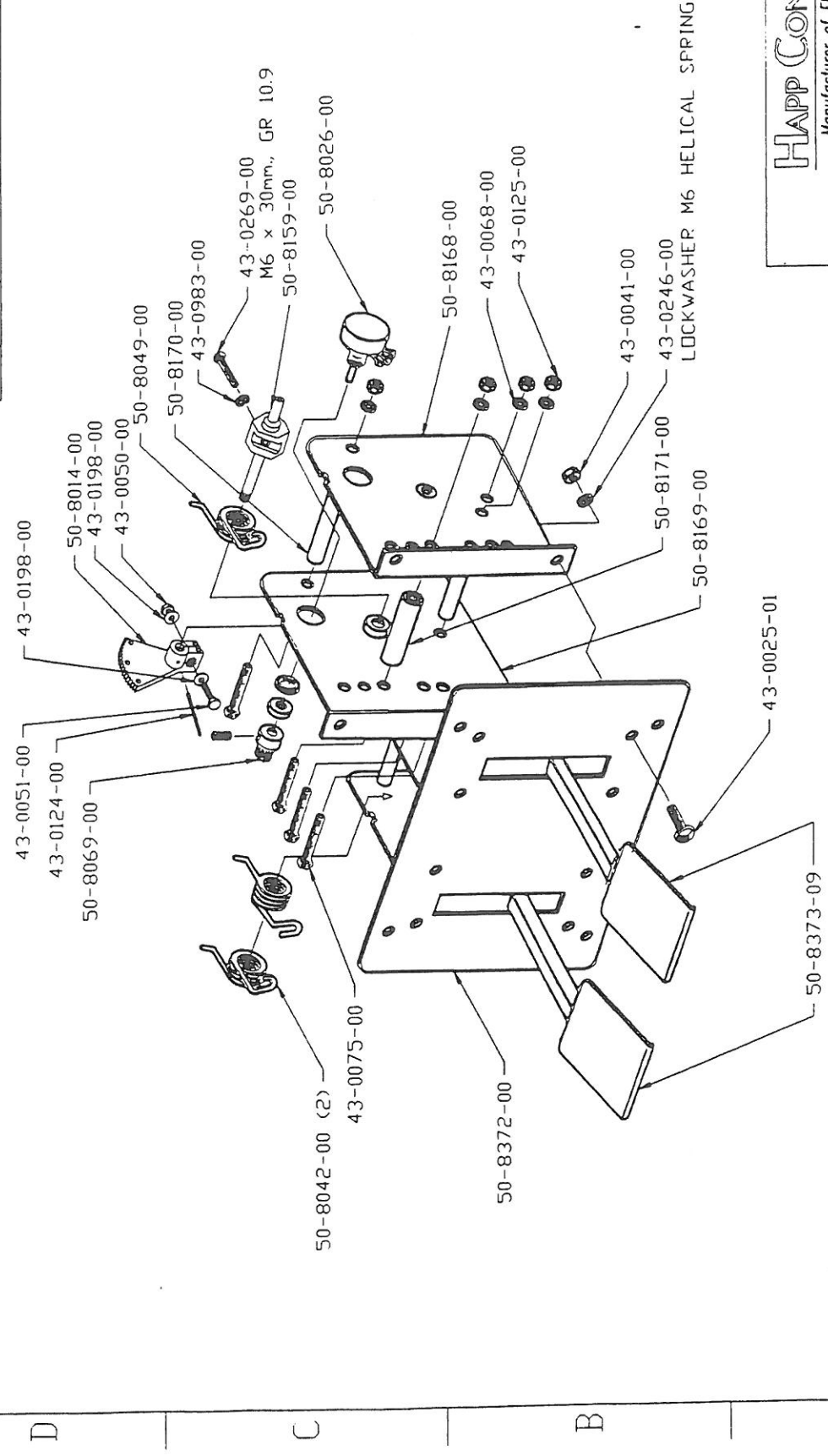

HAPP CONTROLS, inc.
 Manufacturer of Electronic Controls

DRAWING NAME: DUAL PEDAL ASSY., SEGA DAYTONA
 UPRIGHT W/2 BRAKE PEDALS

DRAWN BY: LEE DATE: 4/5/95 CHECKED BY: DATE: 4/5/95

SCALE: FREE SHEET: 1 of 1 DRAWING NO: 50-8060-03

DO NOT SCALE DRAWING.
 THIS PRINT IS THE PROPERTY OF HAPP CONTROLS, INC. AND SHALL NOT BE REPRODUCED, COPIED, NOR DISCLOSED TO OTHERS. PRINT TO BE RETURNED UPON REQUEST.

TOLERANCES ARE: FRACTIONS: ± 1/32 DECIMALS: .XX ± .01 ANGLES: ± 0.30° UNLESS OTHERWISE SPECIFIED DIMENSIONS ARE IN INCH

8-10 TGP TEST

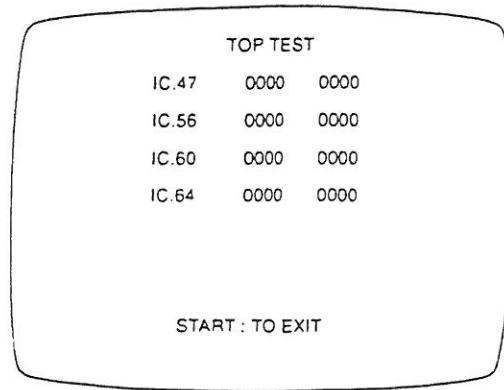

In this test, TGP (on-screen display related IC) is checked. As shown at the left, if "GOOD" is displayed for all, it is satisfactory. Press TEST SW or START BUTTON to return to the menu screen.

FIG. 8.10 TGP TEST

8-11 MEMORY TEST

The MEMORY TEST mode is for checking the on-BD memory IC functioning. "GOOD" is displayed for normal ICs and "BAD" is displayed for abnormal ICs.

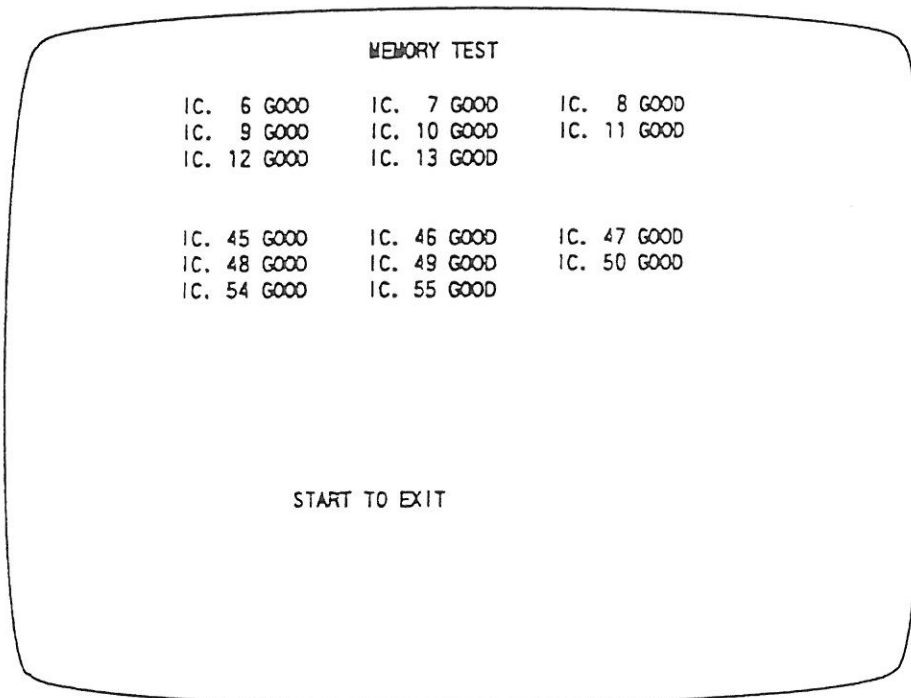

FIG. 8.11 MEMORY TEST

- When the test is completed, if the results are shown as above, it is satisfactory.
- It takes approximately thirty seconds to complete the test. If the period exceeds thirty seconds, this may have been caused by board malfunctioning.
- After finishing the test, pressing the TEST SW or START BUTTON allows the MENU mode to return on to the screen.



8-7 OUTPUT TEST

Choose OUTPUT TEST to cause the following topmost screen to appear. In this test, periodically adjust the monitor and check the status of each lamp.

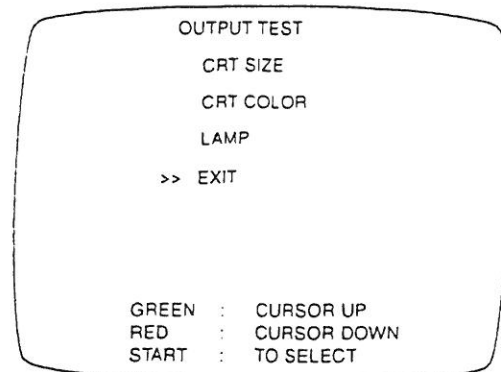

The FIG. at the left shows the menu mode of OUTPUT TEST. Press the SERVICE SW or VR4 (green) /VR1 (red) and bring the arrow (>>) to the desired test item.

Press the TEST SW or START BUTTON to cause the test mode screen below to appear. To return back to the menu mode, bring the arrow to EXIT and press the TEST SW or START BUTTON (FIG. 8.2)

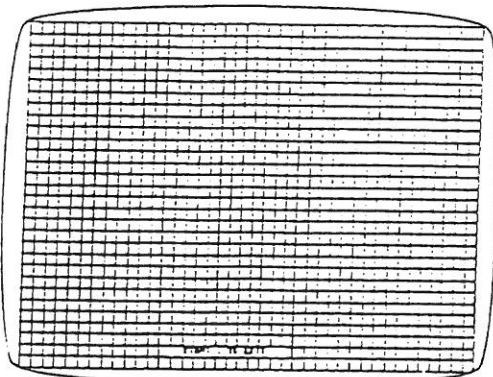

Choose CRT SIZE to cause the screen shown at the left to appear.

Adjust the monitor to make sure that the crosshatch lines do not go beyond the screen size and crosshatch distortion does not occur. Press the START BUTTON to return to the above OUTPUT TEST menu screen.

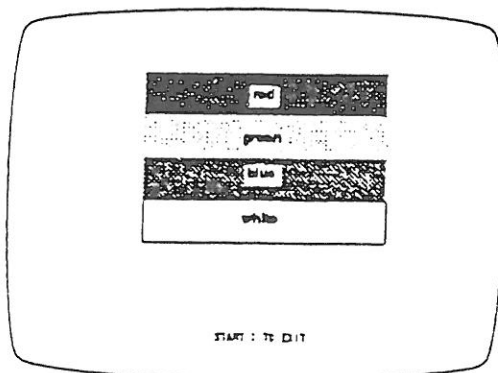

Choose CRT COLOR to cause the screen shown at the left to appear. This test allows the on-screen color adjustment to be performed. The color of a color bar (for each of the 4 colors, i.e., red, green, blue, and white) is darkest at the left most end and brightest at the rightmost end. Press the START BUTTON to return to the above OUTPUT TEST menu screen.

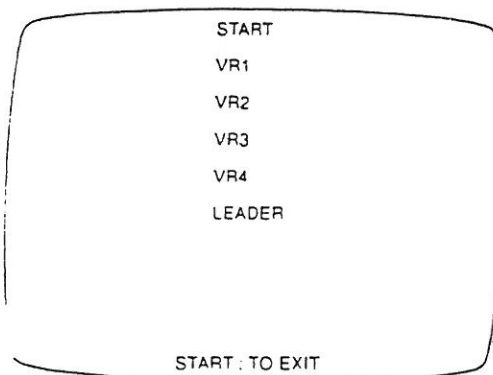

Choose LAMP to cause the screen shown at the left to appear. This enables the status of each lamp to be checked. Causes the START button lamp, the lamp of each V.R. switch, and LEADER lamp to light up in a sequential order. Press the START button to return to the above OUTPUT TEST menu screen.

FIG. 8.7 OUTPUT TEST



8-4 GAME SYSTEM

Selecting the GAME SYSTEM in the menu mode causes the present game setting to be displayed and also the game setting changes can be made. Each item displays the following content.

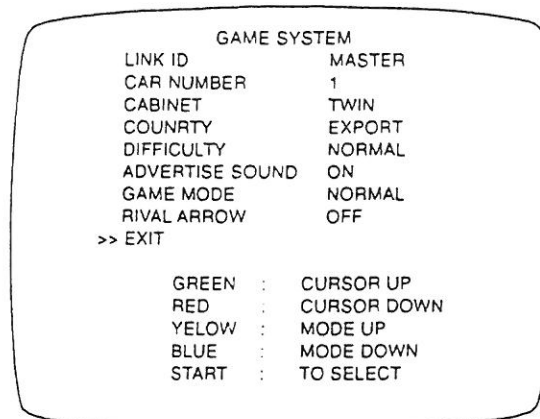

FIG. 8.4 GAME SYSTEM

- **LINK ID:** For communication (interactive) play, set one seat to "MASTER" and the rest of the seats to "SLAVE". The game setting and coin setting, etc. of the MASTER seat apply to the slave seats also. Note that setting changes made by the SLAVE seats are not effective for the game.
- **CAR NUMBER:** For interactive play between 2 or more machines (cabinets), the cabinets (starting from the left, facing the monitor screen) are numbered in the sequential order of No. 1, No. 2, No. 3, No. 4, If the same number is used for 2 or more cabinets or cabinets are numbered in an incorrect sequence, on-screen display may be confused.
- **CABINET:** Setting of cabinet. Set to "TWIN" for this machine.
- **COUNTRY:** Message language (select USA for the U.S.A. , and EXPORT for other countries).
- **DIFFICULTY:** The game difficulty is classified into 4 different categories from EASY to HARDEST. Standard setting is "NORMAL".
- **ADVERTISE SOUND:** Advertisement sound during standby. No sound is produced with "OFF". Standard setting is "OFF".
- **GAME MODE:** Selection of laps. Allows laps to be changed for specific attraction event purposes. NORMAL (8,4 and 2 laps respectively for Beginner, Advanced and Expert.) GRAND PRIX (20, 10 and 5 laps respectively for Beginner, Advanced and Expert). ENDURANCE (80, 40 and 20 laps respectively for Beginner, Advanced and Expert).
- **RIVAL ARROW:** Selection of ARROW(s) indicating rival car(s). ON to display. OFF not to display.

SETTING CHANGE PROCEDURE

- ① Press the SERVICE SW or VR1 (red), or VR 4 (green) to move the arrow (>>) to the desired item.
- ② Choose the desired setting change item by using any one of VR2 (blue), VR3 (yellow), TEST SW and START BUTTON.
- ③ To return back to the MENU mode, move the arrow to EXIT and press the TEST SW or START BUTTON.



8-1 SWITCH UNIT

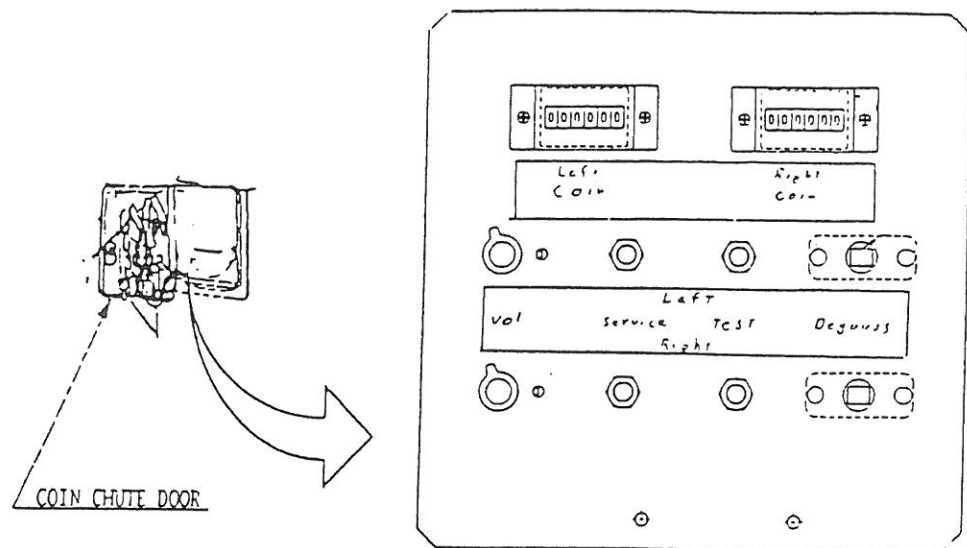
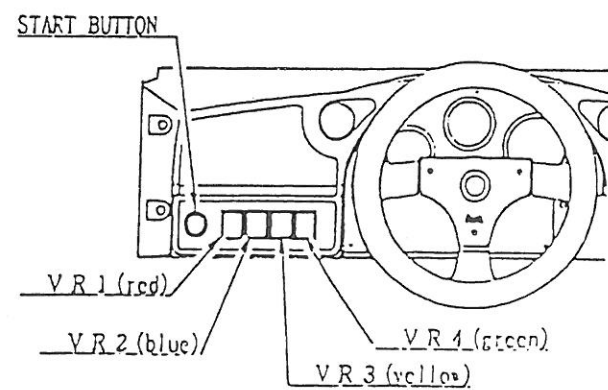

FIG. 8.1 SWITCH UNIT

Open the coin chute door, and the switch unit shown will appear. The functioning of each SW is as follows:

- TEST SWITCH: For the handling of the test button, refer to the following pages.
- SERVICE SWITCH: Gives credits without registering on the coin meter.
- SOUND VOLUME: Adjusts the volume of the monitor's right-hand side and left-hand side speakers, the control panel's right/left tweeters and the superwoofer under the seat.
- DEMAGNETIZER SWITCH: Eliminates color unevenness from the screen.

The control panel switches are also used in the test mode. For each functioning, refer to the following page and onward.



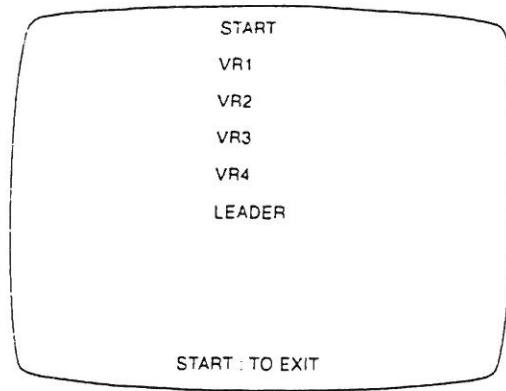

In the LAMP TEST mode, carry out the lamp test to ascertain that each lamp lights up satisfactorily.

(4) SOUND TEST

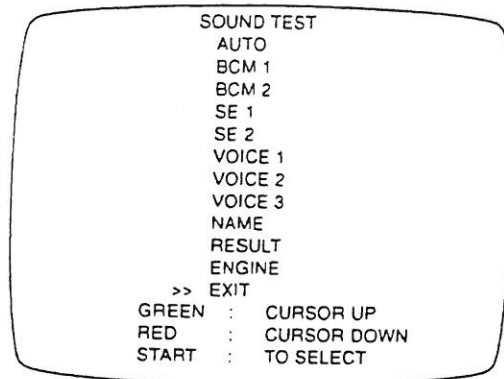

In the TEST mode, selecting SOUND TEST causes the screen (on which sound related BD and wiring connections are tested) to be displayed.

Be sure to check if the sound is satisfactorily emitted from each speaker and the sound volume is appropriate.

Perform the above inspections also at the time of monthly inspection.



3. PRECAUTIONS CONCERNING INSTALLATION LOCATION

The DAYTONA USA is an indoor game machine. Absolutely do not install it outside. Even indoors, avoid installing in places mentioned below so as to ensure proper usage:

- Places subject to rain or water leakage, or condensation due to humidity.
- In the proximity of an indoor swimming pool and/or shower.
- Places subject to direct sunlight.
- Places subject to heat sources from heating units, etc., or hot air.
- Vicinity of highly inflammable/volatile chemicals or hazardous matter.
- Sloped surfaces.
- Vicinity of anti-disaster facilities such as fire exits and fire extinguishers.
- Places subject to any type of violent impact.
- Dusty places.

INSTALLATION PRECAUTIONS

- 1) Do not insert more than one electrical plug into the power plug socket.
- 2) The per unit standard voltage/ampereage is 120V/15A.
- 3) Use of extension cables should be avoided. If you must use, ensure the extension cables are rated at 15A or higher for 120 volt areas
- 4) Note that for transporting the machine into the location's building, the minimum necessary dimensions of the opening (of doors, etc.) are 36 in (W) and 80 in (H).
- 5)

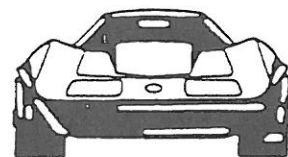

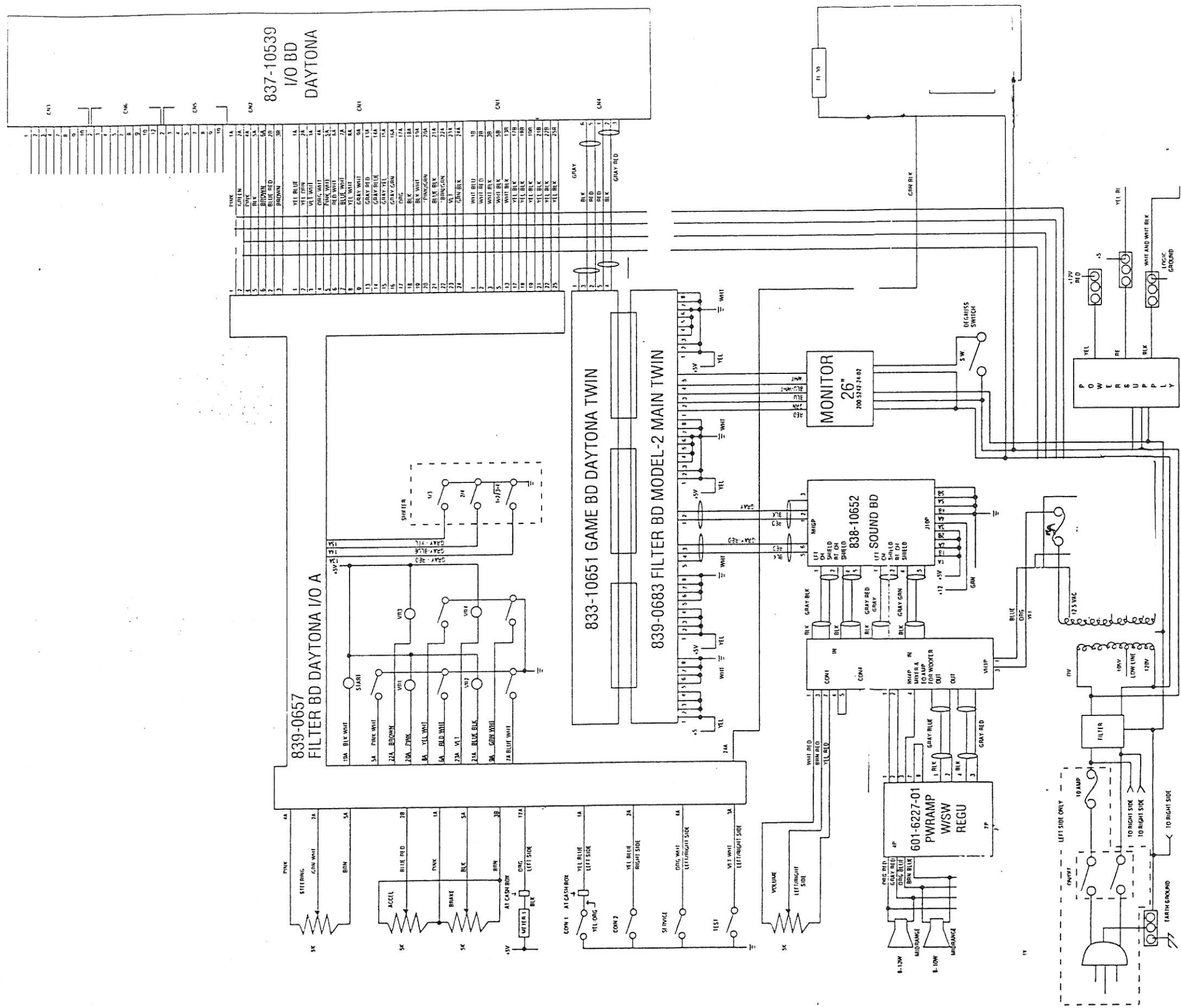

DAYTONA WIRING DIAGRAM
 NOTE: RIGHT SIDE SAME EXCEPT FOR LINE CORD, DIMOFF SWITCH, AND WIRE COLOR ON COIN METER AND COIN SW
 NOTE: EARLY PRODUCTION DID NOT HAVE STRIPE IN WIRE.

PRELIMINARY