

SAMMY GAME CARTRIDGE SYSTEM

FASTER THAN SPEED™

OPERATION MANUAL

**25" UPRIGHT & 27" SITDOWN
DEDICATED CABINET
VIDEO GAME**



Sammy USA Corporation

901 CAMBRIDGE DRIVE
ELK GROVE VILLAGE, IL 60007
TEL: (847) 364-9787 FAX: (847) 364-9831
TOLL FREE: 1-888-US-SAMMY
WWW.SAMMYUSA.COM

Part#: 78-30-300

CONTENTS

1.	SPECIFICATIONS OF CABINET.....	2 to 6
2.	GAME PLAY.....	7 to 8
3.	GAME SETTING.....	9
4.	I/O TEST (CALIBRATION OF STEERING & PEDALS).....	10
5.	SYSTEM BOARD	11 to 15
	EXPANSION CARTRIDGE SLOT 1	11
	JAMMA CONNECTOR TABLE	12
	SPEAKER VOLUME (SOUND)	13
	MODEM CONNECTOR (SRL) >>> OPTION	13
	DIP SWITCH (2 POSITIONS)	13
	STEREO SPEAKER OUTPUT CONNECTOR >>> OPTION	14
	VGA (31KHz) TV SIGNAL OUTPUT CONNECTOR (VDO) >>> OPTION ...	14
	GAME CARTRIDGE	15
6.	SYSTEM MENU	16 to 22
	TEST MODE	17, 18
	COIN SETTING	19, 20
	CONFIGURATION	21
	BOOKKEEPING	22
	BACKUP CLEAR	23
7.	LINK CABLE (OPTION) & SETTINGS	24, 25
	25" UPRIGHT, BENCH SEAT INSTALLATION	26
	25" UPRIGHT, STEERING CONTROL PANEL INSTALLATION ..	27
	WIRING DIAGRAM FOR ATOMISWAVE GAME CABINET	
	WIRING DIAGRAM FOR DRIVING GAME CONTROL	

1. SPECIFICATIONS OF CABINET

25" UPRIGHT CABINET WITH BENCH

INPUT POWER: USA&CANADA = 120VAC, 60Hz

SIZE: W = 30" (762 mm)

WEIGHT: 360 lbs (164 kg)

D = 62" (1575 mm)

H = 77" (1956 mm)



INSIDE VIEW OF CONTROL PANEL & INSTRUCTION PANEL

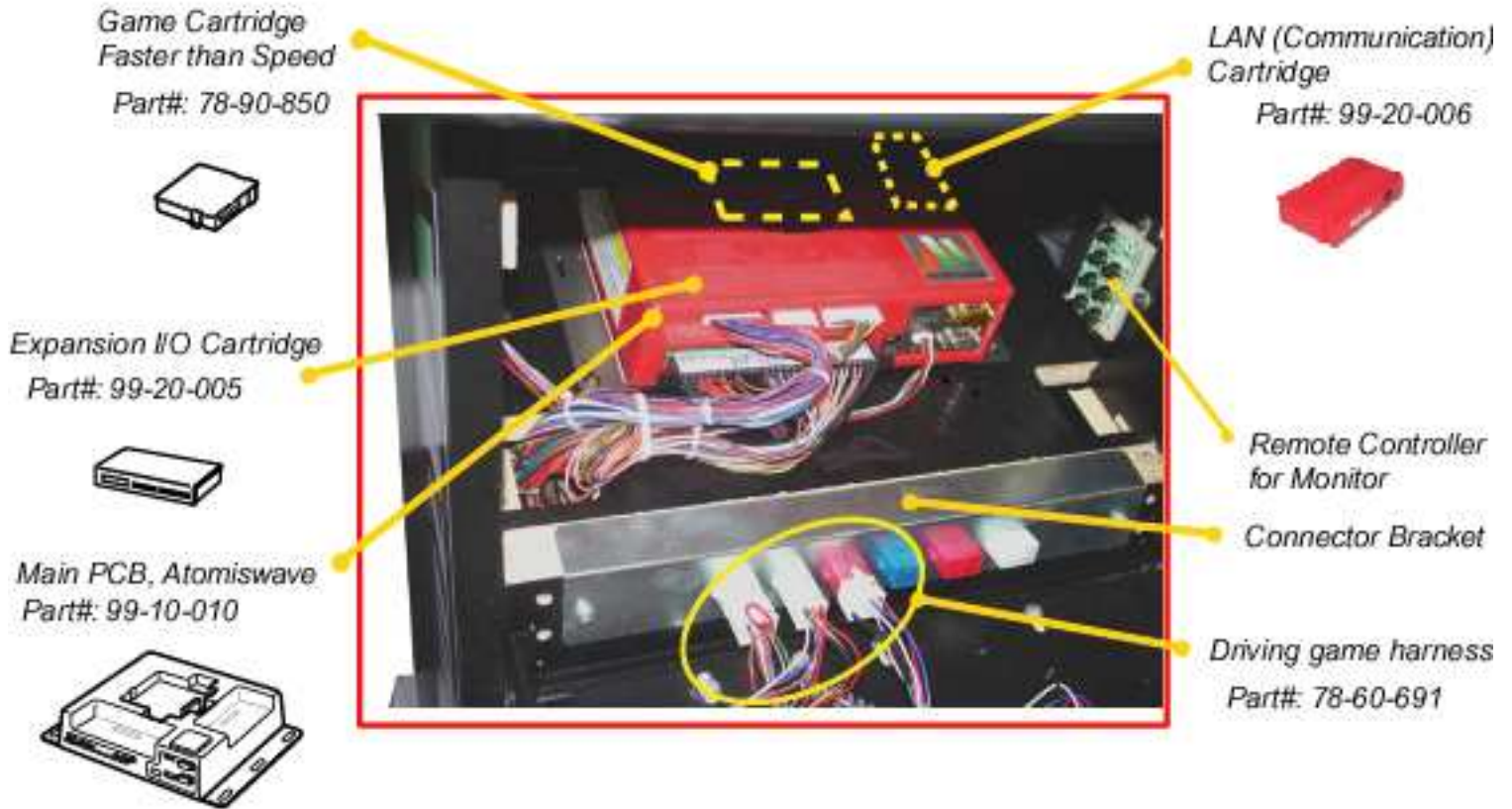

STEERING WHEEL ASSY

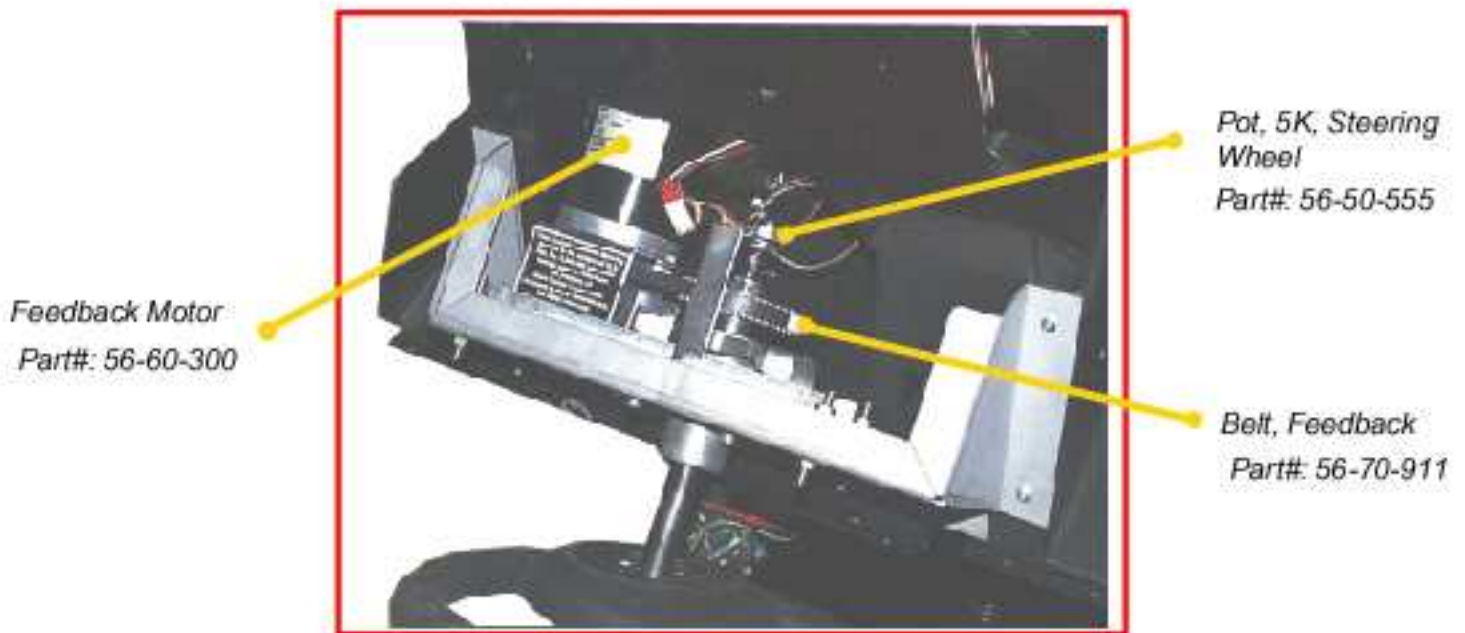

INSIDE VIEW OF BACK DOOR (UPRIGHT)

Motor Driver Board
24VDC IN

Part#: 99-20-176



Cash box
(Back view)

Power Supply
24VDC 6.5A
Part#: 99-60-101



INSIDE VIEW OF COIN DOOR (UPRIGHT)

Test & Service
Switch Bracket

Coin-in
counter meter

Mars DBA
AE2451 (OPTION)

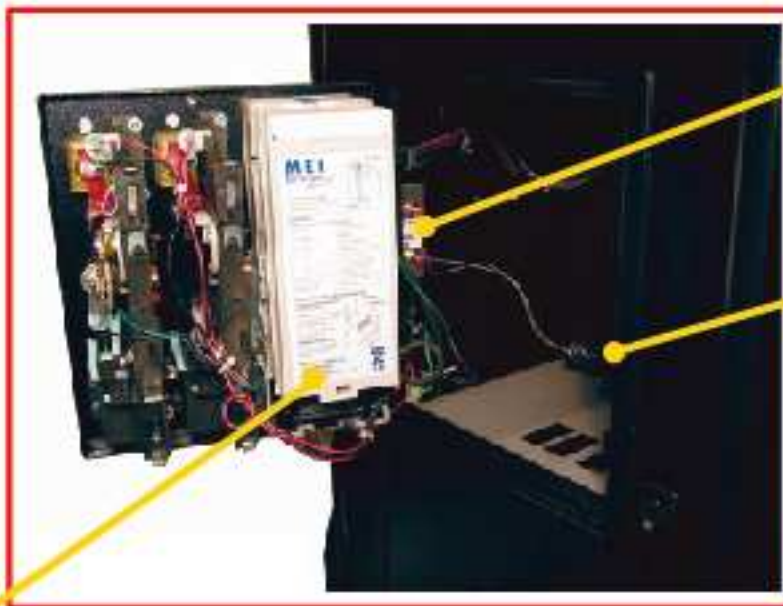

27" SITDOWN CABINET

INPUT POWER: USA&CANADA = 120VAC, 60Hz

**SIZE: W = 30" (762 mm)
D = 64" (1626 mm)
H = 78" (1980 mm)**

WEIGHT: 460 lbs (209 kg)



INSIDE VIEW OF BACK DOOR (SITDOWN)

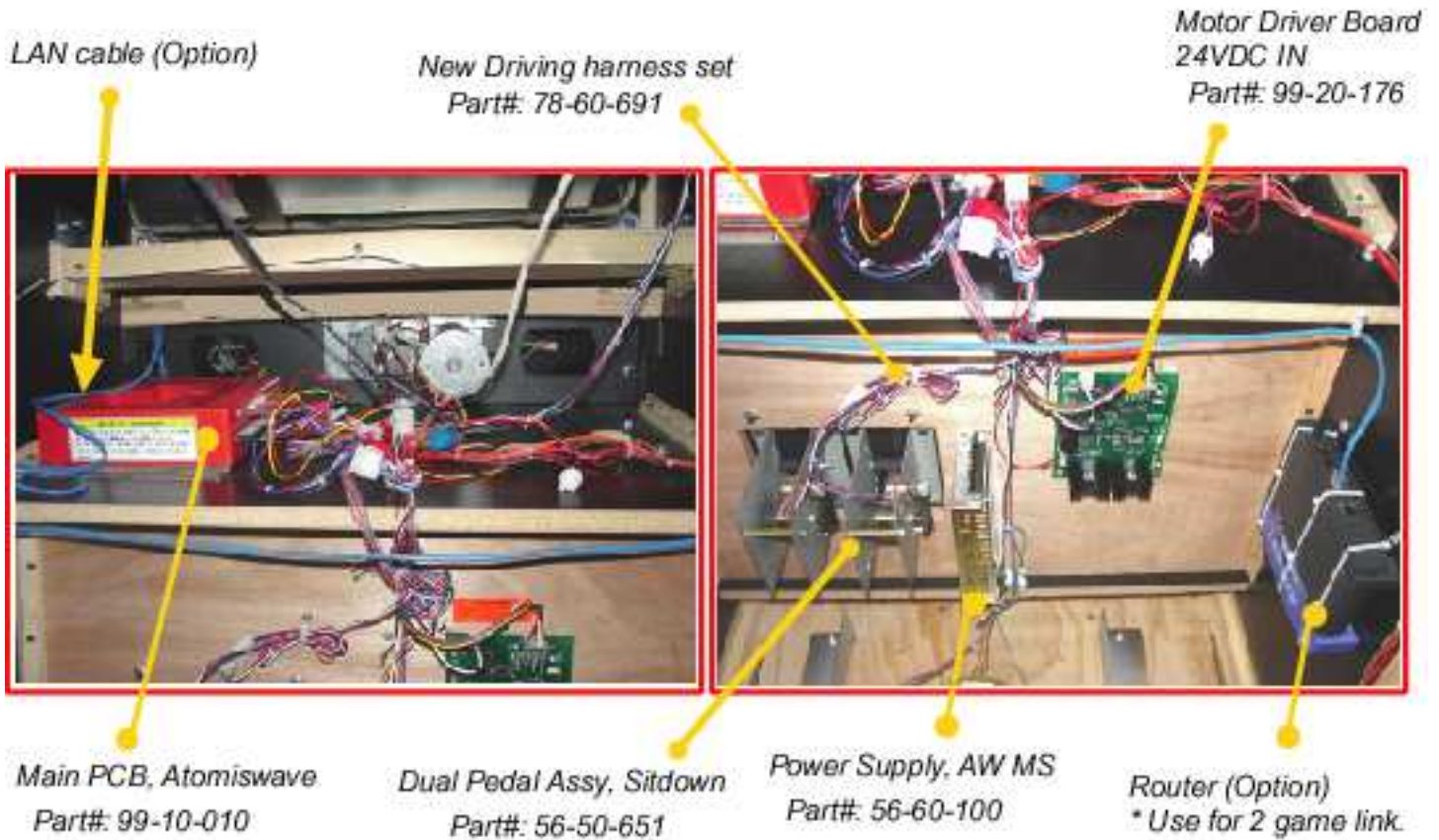

INSIDE VIEW OF COIN DOOR (SITDOWN)

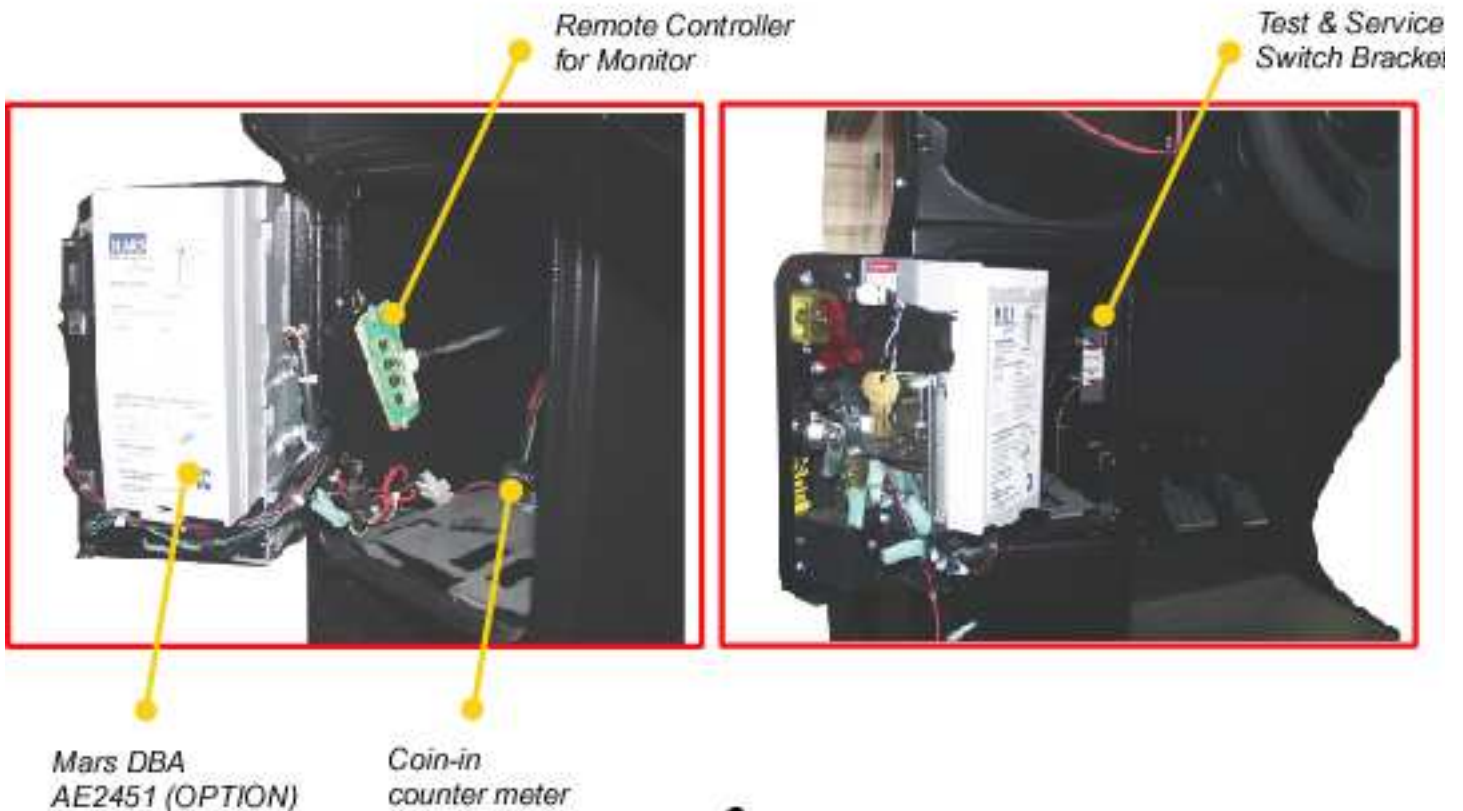

2. GAME PLAY

FASTER THAN SPEED game is a Head-to-Head Competition Driving game with Street Racing cars.

There are GREAT skill factors that you will need to win a race! Play more to find out many of these features.

(NITRO BOOST, ROCKET START, 180 TURN, DRIFT THRU TURN, QUICK SHIFT, HIDDEN CARS, SEMI-AUTO SHIFT...and more~)

FEATURES:

- Each area has 2 races. If you win the 1st race, you will receive a hidden car.
- Enter your initials when your Lap time is in the Top 8.

SINGLE PLAY (Refer to page 9 for Settings)

Single cabinet play. No link. Player races against CPU car.

1) Select COURSE. 6 areas as below.

BEGINNER (SUNNYWOOD): Difficulty Level = EASIEST

NOVICE (METRO CITY): Difficulty Level = EASY

ADVANCED (NEON HILLS): Difficulty Level = NORMAL

EXPERT (WALL PARK): Difficulty Level = NORMAL

PRO (SOUTH BEACH): Difficulty Level = HARD

ACE (PACIFIC BAY): Difficulty Level = HARDER

2) Use steering wheel to select from 8 kinds of cars. Shift up and down to select from 6 colors for car. Use gas pedal for final selection of both car and color.



ALTERNATE PLAY: RACE FOR TIME (Refer to page 9 for Settings)

Single cabinet play. No link. Player races with CPU car or 2 to 4 player Alternate play. (You need to set up GAME MODE to ALTERNATE PLAY in GAME SETTING mode. Refer page 9)

Insert coins and screen shows SINGLE PLAY or ALTERNATE PLAY that needs more credits. Move Shift up/down to select but you can not select if there is not enough credits in.

You will score points by RACE LAP TIME and TECHNIQUES during the race. (Boost with jump, Drift thru turn, Rocket start...etc.)
Score high to Rank in top 8 then enter your initials!

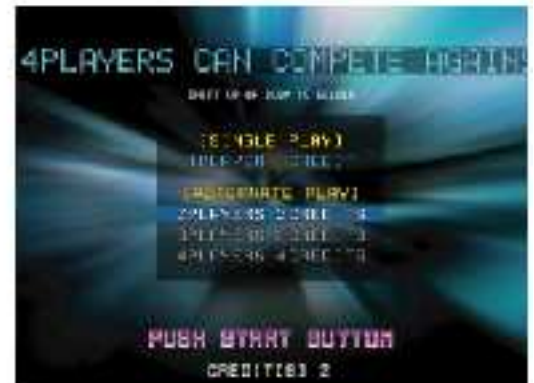

LINK PLAY (Refer to page 9 for Settings)

2 cabinets link play. 2 PLAYER COMPETITION!!!

1) Screen shows "STAND ALONE" OR "HEAD 2 HEAD."

NOTE: Opponents can not join from other cabinet, if you select STAND ALONE.

2) Select COURSE. (Only challenger is able to select COURSE.)



GAME SCREEN



- ① **BACK MIRROR**
Check opponents car by using back mirror!
- ② **ELAPSED TIME**
Display your current TIME.
- ③ **N2O GAUGE**
Display availability of N2O boost.
- ④ **TIME LIMIT**
Displays remaining time.
- ⑤ **NAVIGATION MAP**
Displays both cars' current position.
- ⑥ **SPEEDOMETER**

3. GAME SETTING

FASTER THAN SPEED has the following settings. Press **TEST** switch to display **SYSTEM MENU** screen. Select **CONFIGURATION** and next select **GAME SETTING**. You can adjust the following game settings:

■ GAME MODE

3 kinds. (**LINKED RACE**, **SINGLE RACE** or **ALTERNATE RACE**)
Default is **SINGLE RACE**.

■ GAME DIFFICULTY

5 kinds. (**EASIEST**, **EASY**, **NORMAL**, **HARD** or **HARDEST**) Default is **EASY**.

■ BOOST TYPE

Number of times that player can use Boost during game.
3 kinds. (**LEVEL 1 = 2 times**; **LEVEL 2 = 3 times**; or **UNLIMITED**)
Default is **LEVEL 2**.

■ STAGE TYPE

2 kinds. (**PRE-SET = 1 and 2 stages**,
SELECTABLE = You can select 2nd stage from other area.) Default is **PRE-SET**.

■ CAR SELECTED

6 kinds. (**TIME RELEASE**, **8**, **9**, **10**, **11** or **ALL**) Default is **TIME RELEASE**.

TIME RELEASE = 8 cars first, one additional car will be added each week up to 12.
8,9,10,11 = Number of cars that will appear from beginning. No time release.
ALL = All 12 cars appear from beginning. No time release.

■ RIVAL CAR

2 kinds. (**RANDOM** or **PRE-SET = Same opponents car by each area and stage**) Default is **PRE-SET**.

■ VS BOOSTER

2 kinds. (**ON** or **OFF**) When 2 games in **LINK** mode, 2nd Place **CAR** will catch up faster. Default is **ON**.

■ NAVIGATION MAP

2 kinds. (**ON** or **OFF**) Display **NAVIGATION MAP** on left bottom of screen. Default is **ON**.

■ SPEEDOMETER

2 kinds. (**MPH** or **KMH**) Default is **MPH**.



COIN SETTING:

FACTORY DEFAULTS for FASTER THAN SPEED (NORTH AMERICAN VERSION)

GAME MODE: NORMAL

COIN CHUTE TYPE: COMMON

PLAYER MODE: 2 PLAYERS

COIN CHUTE #A: 3 COINS 1 CREDIT, 2 COINS CONTINUE

COIN CHUTE #B: 3 COINS 1 CREDIT, 2 COINS CONTINUE

PRESET SITUATION: NORMAL

NOTE:

During LINK mode (2 games linked), please set up both games to same GAME SETTINGS except LINK ID.

4. I/O TEST (CALIBRATION OF STEERING & PEDALS)

For Steering Wheel & Pedal calibration and other switch function tests, go to TEST MENU and select I/O TEST.

I/O STATUS

You can test START, BOOST buttons and Shift Assy and, other switch devices during this mode. Using the Shift lever displays HIGH or LOW on-screen. Press START, BOOST buttons to display ON on screen. Test other switches (Coin A, B, Service, Test) in this screen by manually pressing to display ON.

WHEEL STRENGTH

You can set up strength of Steering Wheel Feedback during this setting. Choose from 4 kinds. (OFF, LIGHT, NORMAL and HEAVY)
Default = NORMAL

WHEEL FEEDBACK TEST

You can test Feedback strength during this mode. Please center the wheel before going into this mode.



CONTROL CALIBRATION

You can adjust the calibration of Steering wheel and pedals during this mode. Please center the wheel before going into this mode.

- ① Turn Steering wheel to Left stop and Right stop.
- ② Press Accelerator pedal down to stop.
- ③ Press Brake pedal down to stop.
- ④ Press START button to complete the calibration.



5. SYSTEM BOARD

DIMENSIONS: 10 2/3" (W) x 9" (D) x 2 1/2" (H)

WEIGHT: 3 lbs

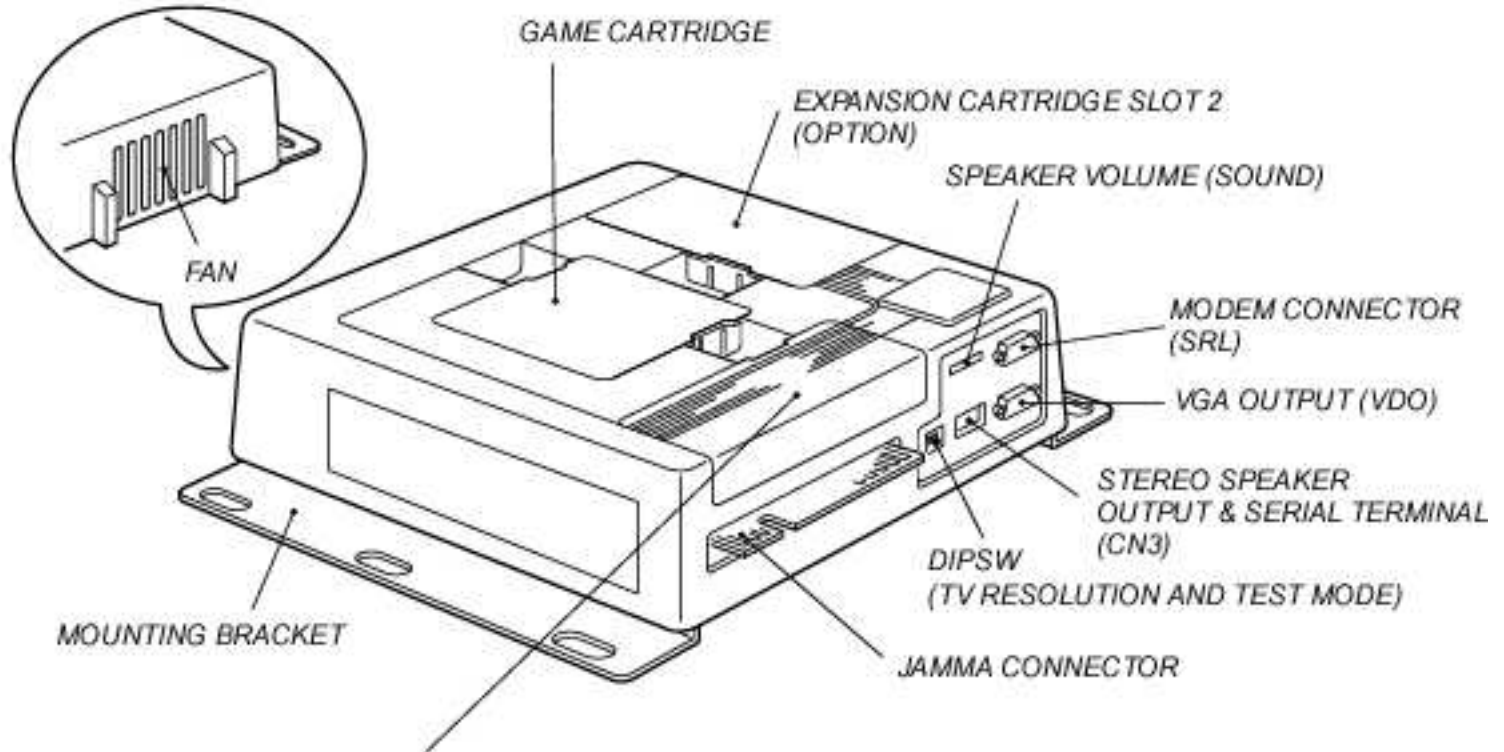

■ EXPANSION CARTRIDGE SLOT 1 (EX. I/O BOARD) CONNECTOR TABLE

CN302: 28 PIN CONNECTOR

PIN#	FUNCTION	PIN#	FUNCTION
1	+5VDC	2	+5VDC
3	GND	4	GND
5	3P GUN	6	4P GUN
7	3PUP/PULX1	8	4PUP/PULX1
9	3PDO/PULX2	10	4PDO/PULX2
11	3PLE/PULY1	12	4PLE/PULY1
13	3PRI/PULY2	14	4PRI/PULY2
15	3P COIN	16	4P COIN
17	3P START	18	4P START
19	3PPU1/TRIG	20	4PPU1/TRIG
21	3P PUSH2	22	4P PUSH2
23	3P PUSH3	24	4P PUSH3
25	3P PUSH4	26	4P PUSH4
27	3P PUSH5	28	4P PUSH5

CN304: 12 PIN CONNECTOR

PIN#	FUNCTION
1	+5VDC
2	+5VDC
3	GND
4	GND
5	POUT 0
6	POUT 1
7	POUT 2
8	POUT 3
9	POUT 4
10	POUT 5
11	POUT 6
12	POUT 7

CN303: 8 PIN CONNECTOR

PIN#	FUNCTION
1	+5VDC
2	+5VDC
3	GND
4	GND
5	ANALOG 0
6	ANALOG 1
7	ANALOG 2
8	ANALOG 3

■ JAMMA CONNECTOR TABLE

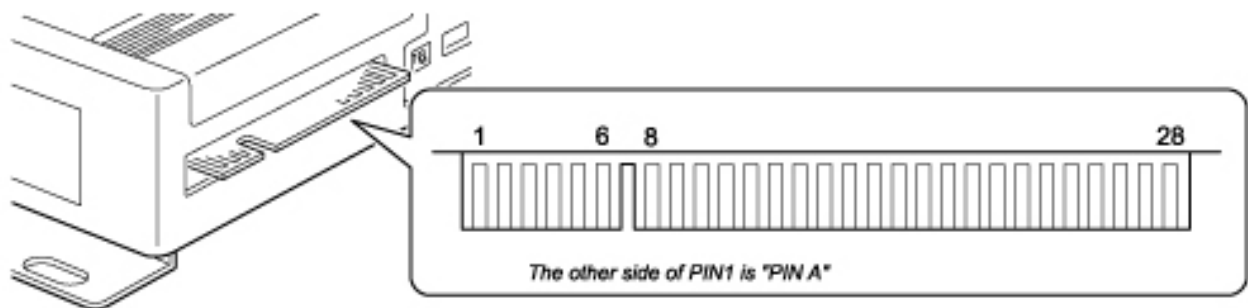

JAMMA EDGE CONNECTOR (56 PINS)

No.	FUNCTION	I/O	No.	FUNCTION	I/O
1	GND	-	A	GND	-
2	GND	-	B	GND	-
3	+5V	IN	C	+5V	IN
4	+5V	IN	D	+5V	IN
5	N.C.	-	E	N.C.	-
6	+12V	IN	F	+12V	IN
7	N.C.	-	H	N.C.	-
8	1P COIN COUNTER	OUT	J	2P COIN COUNTER	OUT
9	1P COIN LOCKOUT	OUT	K	2P COIN LOCKOUT	OUT
10	MONO SPEAKER (+)	OUT	L	MONO SPEAKER (-)	OUT
11	AUDIO OUT	OUT	M	AUDIO GND	-
12	VIDEO RED	OUT	N	VIDEO GREEN	OUT
13	VIDEO BLUE	OUT	P	VIDEO SYNC	OUT
14	VIDEO GND	-	R	SERVICE SW	IN
15	TEST SW	IN	S	TILT SW	IN
16	1P COIN	IN	T	2P COIN	IN
17	START	IN	U	-	IN
18	SHIFT UP	IN	V	-	IN
19	SHIFT DOWN	IN	W	-	IN
20	-	IN	X	-	IN
21	-	IN	Y	-	IN
22	BOOST SW	IN	Z	-	IN
23	-	IN	a	-	IN
24	-	IN	b	-	IN
25	-	IN	c	-	IN
26	-	IN	d	-	IN
27	GND	-	e	GND	-
28	GND	-	f	GND	-

■ **SPEAKER VOLUME (SOUND)**

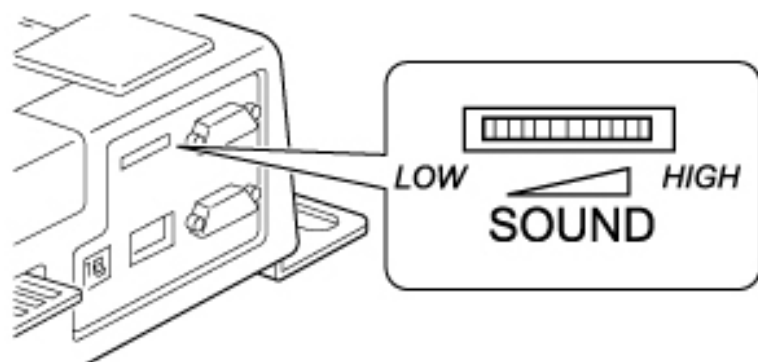

Use for adjusting game sound

■ **MODEM CONNECTOR (SRL) >>> OPTION**

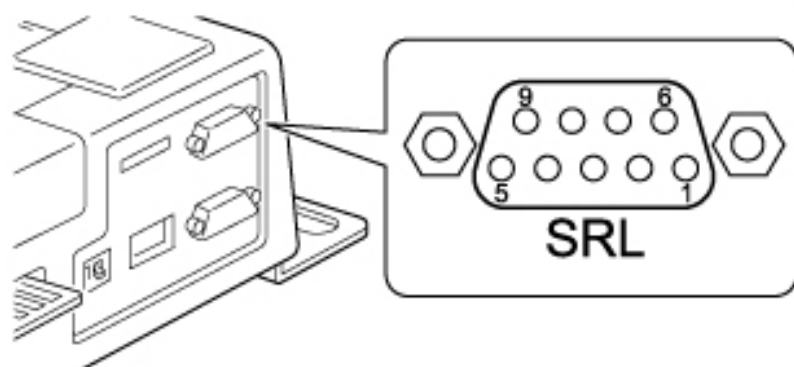

JST 9PIN SUB, CONNECTOR (MALE)

No.	FUNCTION	I/O
1	(N.C.)	-
2	RXD2	IN
3	TXD2	OUT
4	DTR	OUT
5	GND	-
6	(N.C.)	-
7	RTS	OUT
8	CTS	IN
9	(N.C.)	-

■ **DIP SWITCH (2 POSITIONS)**

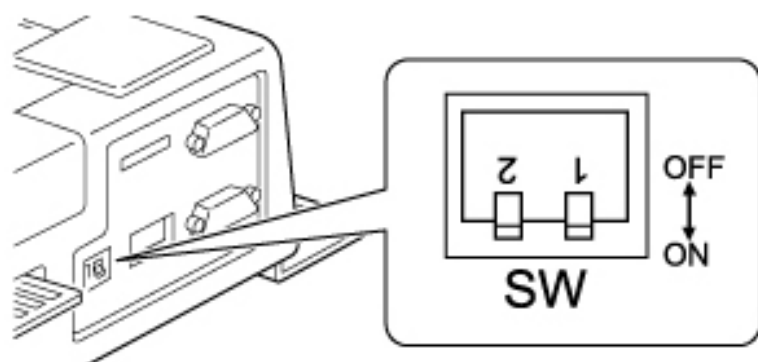

SW-1: Change Frequency of TV signal. Default is OFF = 15KHz*

*For Standard = Low resolution monitor

SW-2: Change ON position to go to SYSTEM MENU.

	ON	OFF
SW-1	31KHZ	15KHZ
SW-2	SYSTEM MENU MODE	GAME MODE

■ STEREO SPEAKER OUTPUT CONNECTOR >>> OPTION

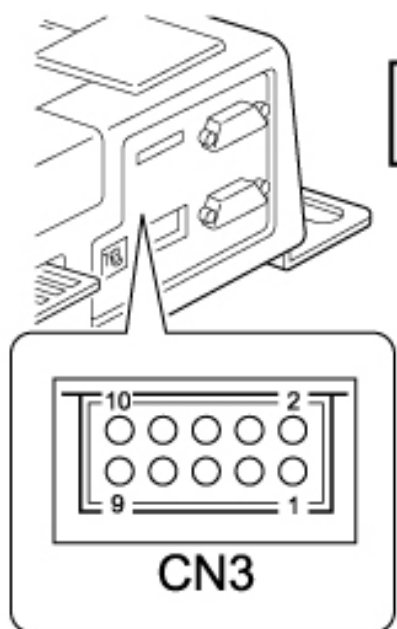

NOTE:
Cannot use JAMMA speaker output & STEREO speaker output at same time.

STEREO SPEAKER OUTPUT & EXTENSION SERIAL CONNECTOR, PIN LAYOUT
(JST, 10 PIN PHD CONNECTOR)

No.	FUNCTION	I/O	No.	FUNCTION	I/O
1	STEREO SPEAKER L (+)	OUT	2	TXD	OUT
3	STEREO SPEAKER L (-)	OUT	4	RXD	IN
5	STEREO SPEAKER R (+)	OUT	6	GND	-
7	STEREO SPEAKER R (-)	OUT	8	+5V	OUT
9	N.C.	-	10	N.C.	-

■ VGA (31KHz) TV SIGNAL OUTPUT CONNECTOR (VDO) >>> OPTION

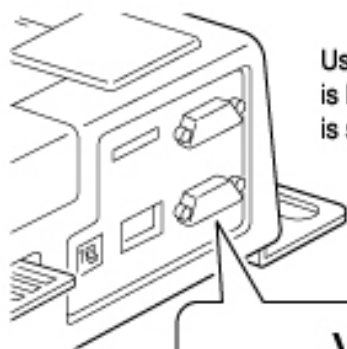

Use this connector when TV Monitor is High Resolution. Make sure DIPSW #1 is set to ON position.

VGA OUTPUT CONNECTOR, PIN LAYOUT
(JST, 15 PIN D-SUB CONNECTOR, 3 SEQUENCE, FEMALE)

No.	FUNCTION	I/O
1	R	OUT
2	G	OUT
3	B	OUT
4	N.C.	-
5	GND	-
6	R-GND	-
7	G-GND	-
8	B-GND	-
9	+5V	OUT
10	GND	-
11	N.C.	-
12	N.C.	-
13	COMP SYNC	OUT
14	N.C.	-
15	N.C.	-

■ GAME CARTRIDGE

HOW TO MOUNT GAME CARTRIDGE

Check position of connector for both game cartridge and slot in MAIN PCB.
Then insert Game Cartridge.
Make sure that Game Cartridge is locked by hooks.

HOW TO REMOVE GAME CARTRIDGE

Pinch both Hooks on game cartridge,
then pull game cartridge out.

When you exchange Game Cartridge with
another Game Cartridge, all backup data
(bookkeeping data) will be cleared.
Settings will go back to default settings.

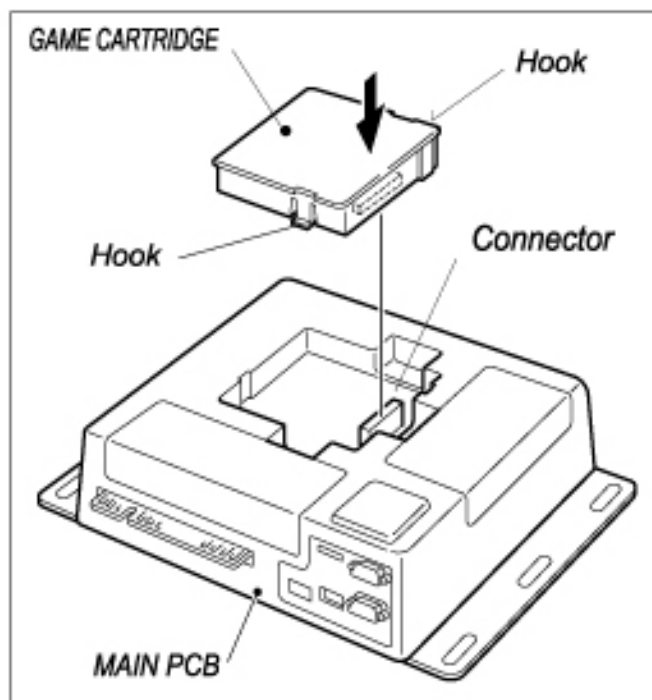

6. SYSTEM MENU

Press **TEST** switch to enter **SYSTEM MENU**.

(**TEST** switch can be activated anytime. Game play will cancel when you press a test switch during game play. Credit[s] will be lost.)

FLOW CHART

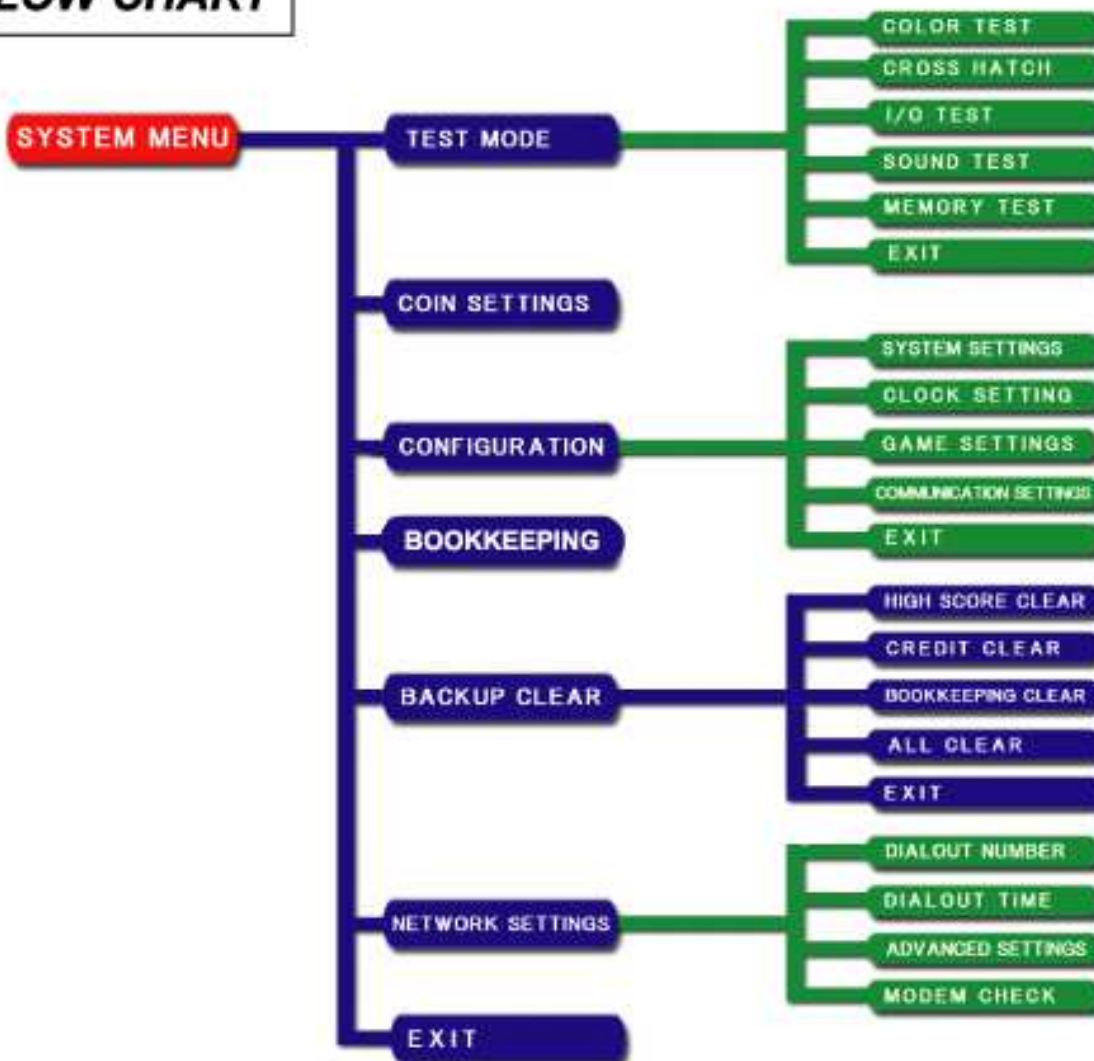

HOW TO CONTROL

Press **TEST** switch to move cursor. Press **SERVICE** switch to select.

(If there is no **TEST** switch in your cabinet, change **DIPSW #2 ON**, re-power on to go to **SYSTEM MENU**. Press **1P START** switch quickly to move cursor. Press & hold **1P START** button to select.)

TOP PAGE OF SYSTEM MENU

Move cursor to contents then select to go to next menu.

Move cursor with TEST switch to EXIT and select to go back to normal game mode. Credit(s) are memorized.



TEST MODE

Use for function test of game.

Select EXIT to go back to top page of SYSTEM MENU.



COLOR TEST

Use for Color adjustment and checking of monitor.

Press SERVICE switch to go back to TEST MODE screen



CROSS HATCH

Use for Size adjustment of monitor.

Press SERVICE switch to go back to TEST MODE screen

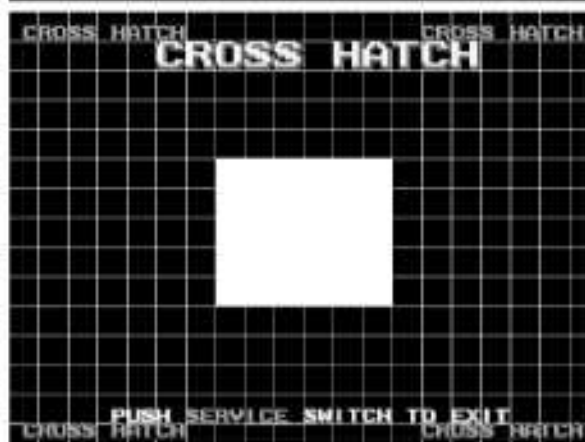

SOUND TEST

*Use for checking Speaker output.
When MONO SPEAKER setting,
select START to output sound.
Select STOP to stop sound.
Select EXIT to go back to
TEST MODE screen*

*When STEREO SPEAKER setting (OPTION),
select RIGHT to output sound from right
speaker.
Select LEFT to output sound from left speaker.
Select CENTER to output sound from both left
& right speakers.
Select STOP to stop sound.
Select EXIT to go back to
TEST MODE screen*

MEMORY TEST

*Use for testing RAM of MAIN PCB.
Press TEST switch to start read
& writing RAM test. Cannot cancel
this test until MEMORY test is complete.
Press SERVICE switch after
tests completed to go back to
TEST MODE screen*



COIN SETTING

WARNING: ALL CREDIT DATA WILL BE LOST WHEN MAKING THE FOLLOWING CHANGES!

GAME MODE

Select *FREE PLAY* or *NORMAL*. Move cursor to *GAME MODE* then press *SERVICE* switch to select *NORMAL (COIN OPERATION)* or *FREE PLAY*.
(Refer Fig.B and C)

COIN CHUTE TYPE

Select *COMMON* or *INDIVIDUAL*. Move cursor to *COIN CHUTE TYPE* then press *SERVICE* switch to select *COMMON* or *INDIVIDUAL* mode.
(Refer Fig.A and B)



Fig. A



Fig. B

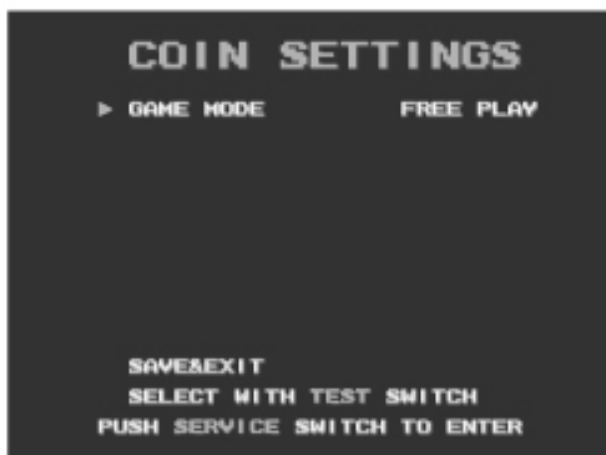

Fig. C

WHEN COIN CHUTE TYPE IS "COMMON"

Credit(s) will display all in one place on screen. Move cursor to coin chute A or B then press SERVICE switch to change setting number. You are able to set up coin chute A and B separately. Select SAVE & EXIT to go back to SYSTEM MENU.

WHEN COIN CHUTE TYPE IS "INDIVIDUAL"

Credit(s) will display on screen by players. Move cursor to coin chute A or B then press SERVICE switch to change setting number. You are unable to set up coin chute A and B separately. Coin chute A & B must be same setting. Select SAVE & EXIT to go back to SYSTEM MENU.

PRESET SITUATION

There is 53 kinds of coin settings.
 When PRESET SITUATION is NORMAL,
 you can select from 14 kinds. (#00 to #09 and
 #45 to #48.) This is basic coin settings line-up.
 When PRESET SITUATION is ADVANCE,
 you can choose from all 53 kinds as shown
 below.

NO	COIN SETTING
#00	1 COIN 1 CREDIT / 1 COIN CONTINUE
#01	2 COINS 1 CREDIT / 1 COIN CONTINUE
#02	2 COINS 1 CREDIT / 2 COINS CONTINUE
#03	3 COINS 1 CREDIT / 1 COIN CONTINUE
#04	3 COINS 1 CREDIT / 2 COINS CONTINUE
#05	3 COINS 1 CREDIT / 3 COINS CONTINUE
#06	4 COINS 1 CREDIT / 1 COIN CONTINUE
#07	4 COINS 1 CREDIT / 2 COINS CONTINUE
#08	4 COINS 1 CREDIT / 3 COINS CONTINUE
#09	4 COINS 1 CREDIT / 4 COINS CONTINUE
#10	5 COINS 1 CREDIT / 1 COIN CONTINUE
#11	5 COINS 1 CREDIT / 2 COINS CONTINUE
#12	5 COINS 1 CREDIT / 3 COINS CONTINUE
#13	5 COINS 1 CREDIT / 4 COINS CONTINUE
#14	5 COINS 1 CREDIT / 5 COINS CONTINUE
#15	6 COINS 1 CREDIT / 1 COIN CONTINUE
#16	6 COINS 1 CREDIT / 2 COINS CONTINUE
#17	6 COINS 1 CREDIT / 3 COINS CONTINUE
#18	6 COINS 1 CREDIT / 4 COINS CONTINUE
#19	6 COINS 1 CREDIT / 5 COINS CONTINUE
#20	6 COINS 1 CREDIT / 6 COINS CONTINUE
#21	7 COINS 1 CREDIT / 1 COIN CONTINUE
#22	7 COINS 1 CREDIT / 2 COINS CONTINUE
#23	7 COINS 1 CREDIT / 3 COINS CONTINUE
#24	7 COINS 1 CREDIT / 4 COINS CONTINUE
#25	7 COINS 1 CREDIT / 5 COINS CONTINUE
#26	7 COINS 1 CREDIT / 6 COINS CONTINUE
#27	7 COINS 1 CREDIT / 7 COINS CONTINUE

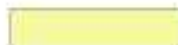

NO	COIN SETTING
#28	8 COINS 1 CREDIT / 1 COIN CONTINUE
#29	8 COINS 1 CREDIT / 2 COINS CONTINUE
#30	8 COINS 1 CREDIT / 3 COINS CONTINUE
#31	8 COINS 1 CREDIT / 4 COINS CONTINUE
#32	8 COINS 1 CREDIT / 5 COINS CONTINUE
#33	8 COINS 1 CREDIT / 6 COINS CONTINUE
#34	8 COINS 1 CREDIT / 7 COINS CONTINUE
#35	8 COINS 1 CREDIT / 8 COINS CONTINUE
#36	9 COINS 1 CREDIT / 1 COIN CONTINUE
#37	9 COINS 1 CREDIT / 2 COINS CONTINUE
#38	9 COINS 1 CREDIT / 3 COINS CONTINUE
#39	9 COINS 1 CREDIT / 4 COINS CONTINUE
#40	9 COINS 1 CREDIT / 5 COINS CONTINUE
#41	9 COINS 1 CREDIT / 6 COINS CONTINUE
#42	9 COINS 1 CREDIT / 7 COINS CONTINUE
#43	9 COINS 1 CREDIT / 8 COINS CONTINUE
#44	9 COINS 1 CREDIT / 9 COINS CONTINUE
#45	1 COIN 2 CREDITS
#46	1 COIN 3 CREDITS
#47	1 COIN 4 CREDITS
#48	1 COIN 5 CREDITS
#49	1 COIN 6 CREDITS
#50	1 COIN 7 CREDITS
#51	1 COIN 8 CREDITS
#52	1 COIN 9 CREDITS

 >>> This color = NORMAL 14 kinds.

CONFIGURATION

4 kinds of contents.
Contents of COMMUNICATION is unavailable when game has no COMMUNICATION feature.

SYSTEM SETTINGS

AREA: Select country of operation.
(JAPAN, NORTH AMERICA, EUROPE or OTHER)
This setting effects factory defaults.

LANGUAGE: Select from following:
(English or Japanese)

ADVERTISE SOUND:
Select to output sound in attract mode.

AUDIO MODE:
Select sound STEREO (OPTION) or MONO.

SOUND VOLUME:
Volume level of sound. Default is "15"

CLOCK SETTING

Adjust clock system on Main PCB.
Move cursor then press SERVICE switch to advance each digit. Press & hold SERVICE switch more than 1 sec. to speed it up.

Move cursor to SAVE & EXIT then press SERVICE switch to go back to SYSTEM MENU screen.

GAME SETTING

Adjust game setting at this mode. (Refer detail on Page 9)
Move cursor to SAVE & EXIT then press SERVICE switch to go back to CONFIGURATION.
Select RETURN TO FACTORY SETTINGS to change all settings to Factory default settings.



BOOKKEEPING

5 kinds. Refer below.

SUMMARY

SRAM on Main PCB records & saves following data.

TOTAL TIME: This is the time when game is powered on.

TOTAL PLAYTIME: Play Time.

COIN #A: Total coins of COIN CHUTE 1.

COIN #B: Total coins of COIN CHUTE 2.

COIN #C: Total coins of COIN CHUTE 3.

COIN #D: Total coins of COIN CHUTE 4.

TOTAL COIN: Total coins of COIN #A, B, C, and D.

COIN CREDIT: Number of credits by coins in.

SERVICE CREDIT: Number of SERVICE credits.

TOTAL CREDIT: Total of COINS + SERVICE CREDITS.

NORMAL START: Number of games started from beginning.

CONTINUE START: Number of games started from beginning.

NETWORK START 1: Number of NETWORK plays on Cabinet 1.

NETWORK START 2: Number of NETWORK plays on Cabinet 2.

NETWORK START 3: Number of NETWORK plays on Cabinet 3.

NETWORK START 4: Number of NETWORK plays on Cabinet 4.



DAILY PLAY DATA1

Display Average play time for each play by Day.

DAILY PLAY DATA1

DATE	PLAY	COUNT	AVERAGE PLAY TIME
20/10/83 FRI	0	0	0h 0m 0s

PUSH SERVICE SWITCH TO EXIT

MONTHLY PLAY DATA1

Display Average play time for each play by Month.

MONTHLY PLAY DATA1

DATE	PLAY	COUNT	AVERAGE PLAY TIME
Oct -83	0	0	0h 0m 0s
TOTAL	0	0	0h 0m 0s

PUSH SERVICE SWITCH TO EXIT

DAILY COIN DATA1

Display number of coins for each play by Day.

DAILY COIN DATA1

DATE	Co#A	Co#B	Co#C	Co#D	SERV
20/10/83 FRI	0	0	0	0	0

PUSH SERVICE SWITCH TO EXIT

MONTHLY COIN DATA1

Display number of coins for each play by Month.

MONTHLY COIN DATA1

MONTH	Co#A	Co#B	Co#C	Co#D	SERV
Oct -83	0	0	0	0	0
TOTAL	0	0	0	0	0

PUSH SERVICE SWITCH TO EXIT

BACKUP CLEAR

*Clear following data in MAIN PCB.
(HIGH SCORE, CREDIT CLEAR,
BOOKKEEPING CLEAR and ALL CLEAR)*

*Press SERVICE to select each contents then
go to each data clear screen.*

*In each data clear screen, Press TEST switch
to move cursor to "YES" then press
SERVICE switch. After finishing data clear,
screen will go back to BACKUP CLEAR screen.*

BACKUP CLEAR

- ▶ HIGH SCORE CLEAR
- CREDIT CLEAR
- BOOKKEEPING CLEAR
- ALL CLEAR
- EXIT

SELECT WITH TEST SWITCH
PUSH SERVICE SWITCH TO ENTER

7. LINK (OPTION) & SETTINGS

FASTER THAN SPEED needs a LAN CABLE & ROUTER to LINK 2 games. (OPTION)



SUGGESTED ROUTER
 Maker: LINKSYS
 Model: BEFSR41



Power Adaptor
 (Included w/ ROUTER)



LAN (Ethernet) Cable (2)
 * One LAN cable included
 in ROUTER kit.
 You will need to purchase
 only one LAN cable.



AC Tap
 Maker: Cooper

HOW TO CONNECT

- 1) (UR game) Open control panel and Instruction bracket to locate Main PCB. (Sit-down game) Open back door to locate Main PCB.
- 2) Connect 2 LAN cable connectors to LAN cartridge on both Main PCBs. (See Below)
- 3) Connect the other ends of LAN cable connectors to ROUTER. (Refer below picture for connection)
- 4) Remove 120VAC (For DBA) plug from outlet of Power Supply box and connect AC Tap. Then re-plug 120VAC (For DBA) plug back to AC Tap and plug Power Adaptor of ROUTER to AC Tap.
- 5) Use drill to make hole for cable in both back doors then mount ROUTER to one of the cabinets inside. (You may need wood screws and wire tights)
- 6) (UR game) Close Instruction bracket and Control panel. (Sit-down game) Close Back door.
- 7) Refer to next page to set up communication setting.

BACK VIEW OF ROUTER



**DO NOT CONNECT
 HERE. (NOT USED)**

Connect 2 LAN Cable
 connectors to 2 ports
 out of 4

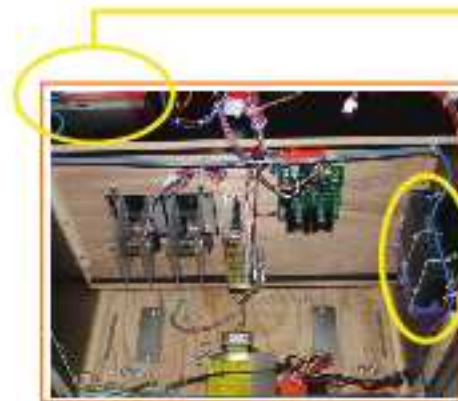

View, inside of cabinet (Sit-down)



Connect LAN cable to LAN
 (Communication) cartridge
 on Main PCB, AW



Mounting view, ROUTER (Sit-down)

COMMUNICATION ERROR

Left top on screen shows error code "ERROR LINKING PROBLEM" in red letters. Please check as below.

- 1) LAN Cable connections.
- 2) Power on ROUTER unit.
- 3) LAN Cartridge mounting on Main PCB.
- 4) Check communication setting of both cabinets. (Refer next page)

After checking above, reset both machines.



COMMUNICATION SETTING

Set up LINK play in this mode. Go to "CONFIGURATION" then select "COMMUNICATION SETTING." Do the following:

LINK MODE

2 kinds of settings. ("ON" or "OFF") "ON" for "LINK PLAY". Default is "OFF."



LINK ID

2 kinds of settings. ("MASTER" or "SLAVE") One side must be "MASTER" and other side must be "SLAVE."



How to test:

Screen shows result of test. If any errors, refer below. "EXIT" to return to CONFIGURATION screen.

DIAGNOSTIC RESULT

OK >>> No problem. Both cabinets are linked.

HARDWARE CONDITION NG

Check Link cable and other device (Router, LAN Cartridge and Main PCB) connections.

SETTING CONDITION NG

Both cabinets are set as "MASTER". Change "LINK ID" setting for one cabinet to "SLAVE."
Both cabinets are set as "SLAVE". Change "LINK ID" setting for one cabinet to "MASTER."

NOTE:

During LINK mode (2 games linked), please set up both games to same GAME SETTINGS except COMMUNICATION CLASS.

BENCH SEAT ASSY INSTALLATION

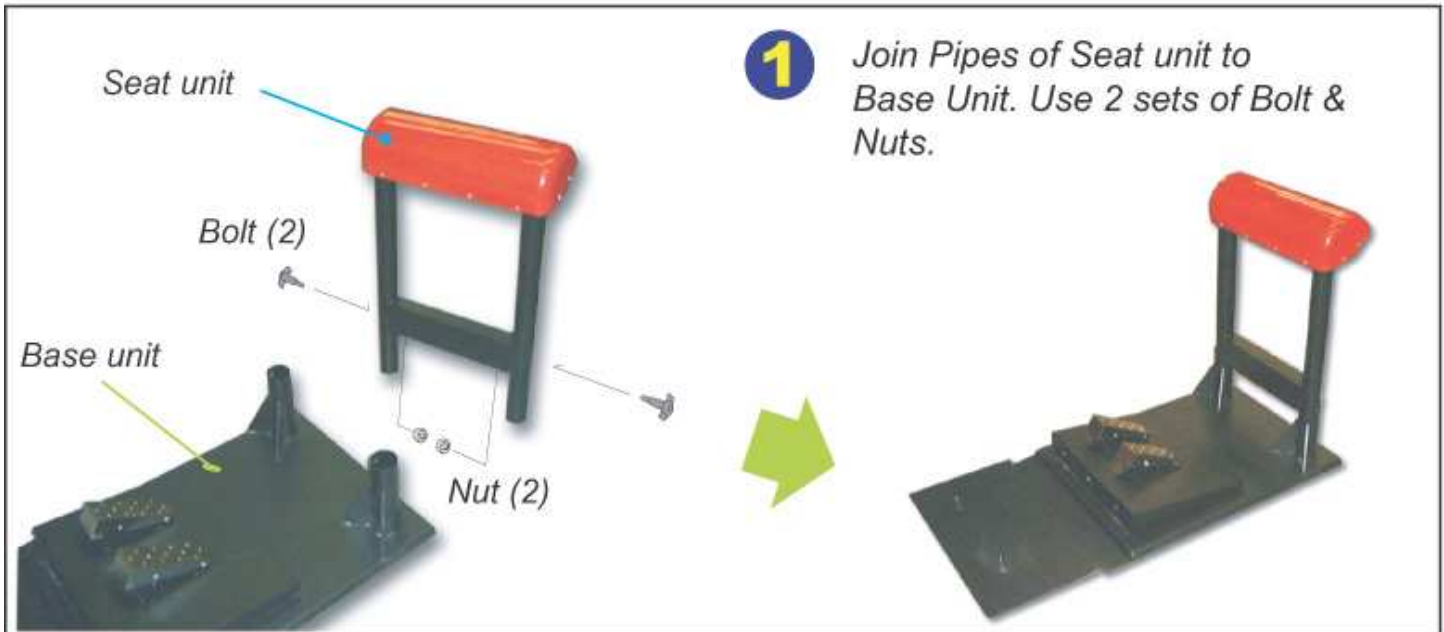

- 2** Place Main cabinet to SEAT ASSY as indicated. The 2 Stud bolts on base fit in bolt holes on bottom of cabinet base wood. Open back door of cabinet then use plain washers & Nuts to secure together.

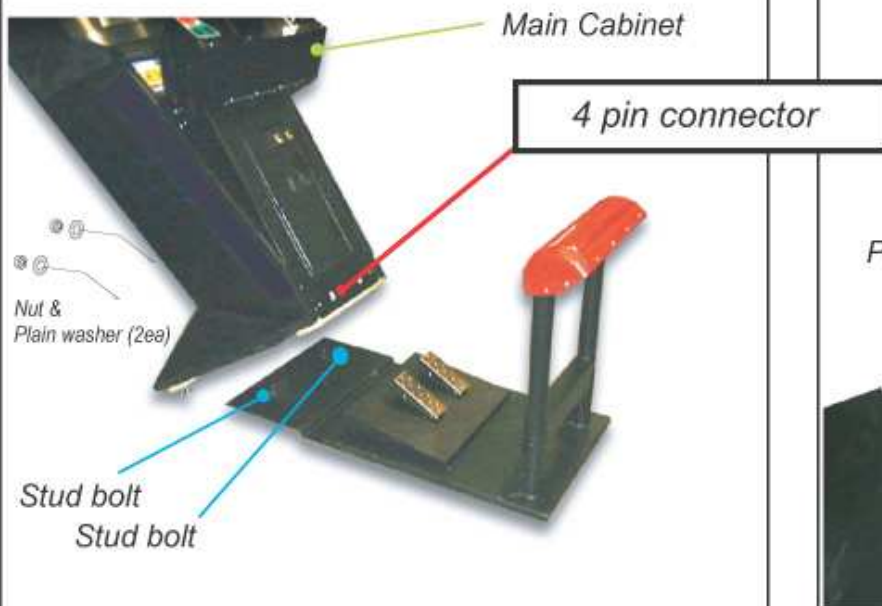

- 3** Remove 3 screws from Left & Right to open Pedal base. Connect Pedal Harness connector to 4 pin connector located at bottom of Main cabinet. Close Pedal base.



STEERING CONTROL PANEL INSTALLATION

- 1** Use Key to Open Steering Control panel Assy. Use 6 screws to mount it. Then Use 4 screws to mount Support Bracket under control panel.



Side view
when control panel is mounted.



- 2** Connect driving harness connectors as below. Close Control panel with locks after connecting all connectors.

Motor connector

5K pot connector

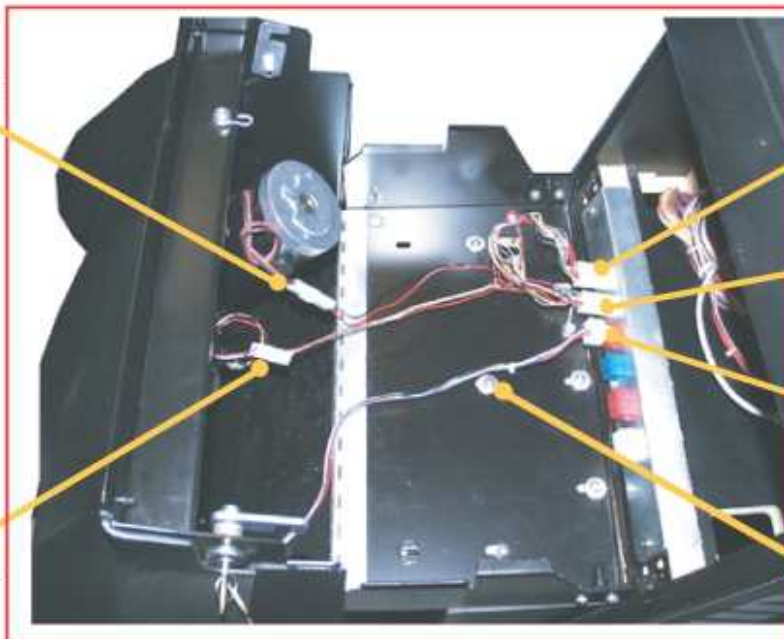

N connector
(12 pins)

M Connector
(9 pins)

1P connector
(12 pins)

Screws & Washers
for mounting (6 sets)

WARRANTY

Limited warranty, Repair and Return Policy

Sammy USA Corporation warrants all products to be free from defective materials and workmanship for a period of thirty (30) days from the Sammy USA Corporation invoice date unless otherwise specified in writing by Sammy USA Corporation. The extent of this warranty applies to all electronic assemblies only, and does not include lamps and fuses.

This limited warranty is invalid for any product that upon examination, is deemed to have been subject to misuse, improper repair or installation, neglect or violation of specification or other instructions published by Sammy USA Corporation.

There are no additional warranties described above.

The limited warranties described above shall be in lieu of any other warranty, express or implied, including but not limited to any implied warranty of merchantability or fitness for a particular purpose.

Return Merchandise Authorization

- 1. Contact your authorized Sammy USA distributor to receive a Return Merchandise Authorization for return.*
- 2. You must obtain RMA numbers from Sammy USA Corporation through an authorized Sammy USA distributor. Please have your serial number available when calling for RMA number.*
- 3. All items must have an RMA number marked clearly on the outside of the package.*
- 4. Products must be shipped prepaid. Products returned without an RMA number will not be accepted.*
- 5. Credits to accounts are subject to inspection of products for damage and suitability for resale.*

CONNECTOR BRACKET (INSIDE OF CONTROL PANEL)

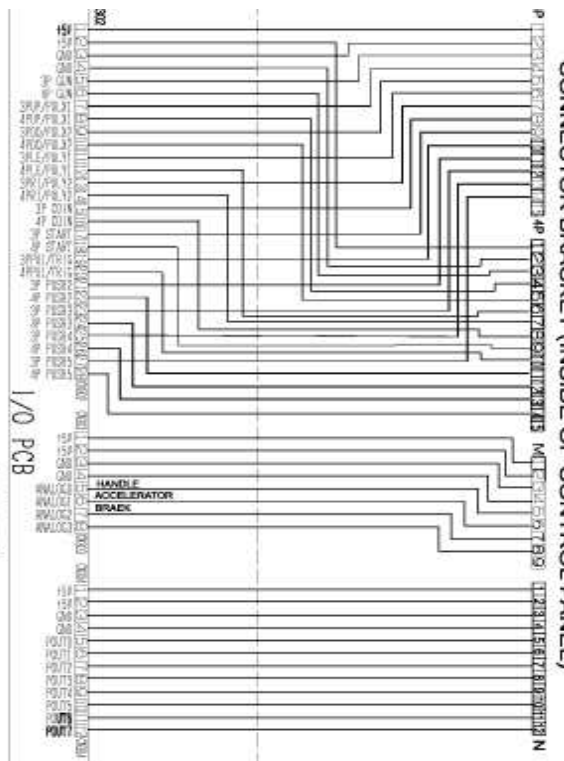

SPEAKER
8 OHL, 15W



SPEAKER
8 OHL, 15W



25V TV Assy
Wellsgardner
(15.75khz)



MARQUEE BOX



MAIN PCB

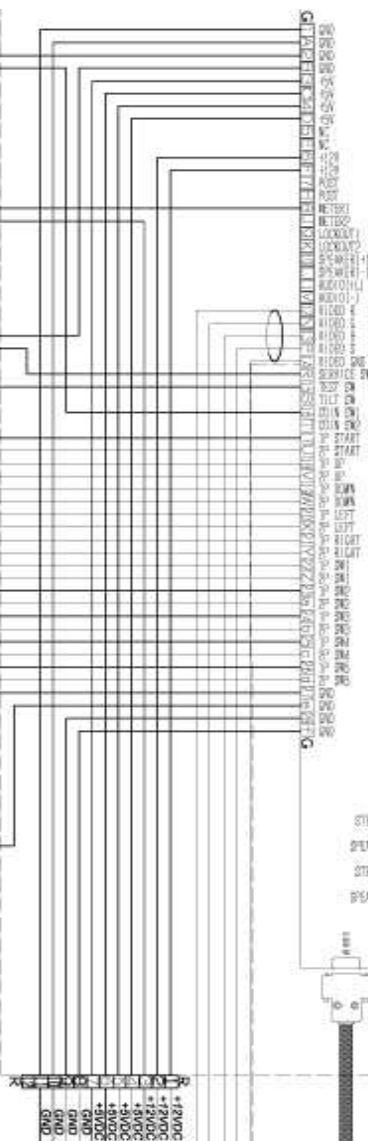

CONNECTOR BRACKET (INSIDE OF CONTROL PANEL)

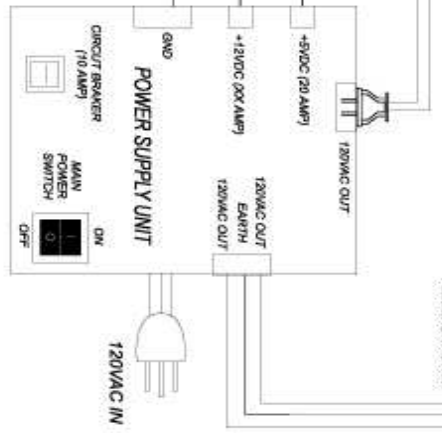

CONNECT TO TRANSFORMER FOR MOTOR FEEDBACK POWER

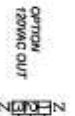

CABINET WIRING DIAGRAM
25" UR CABINET

Sammy USA Corporation USA, CANADA version (120VAC, 60Hz IN)

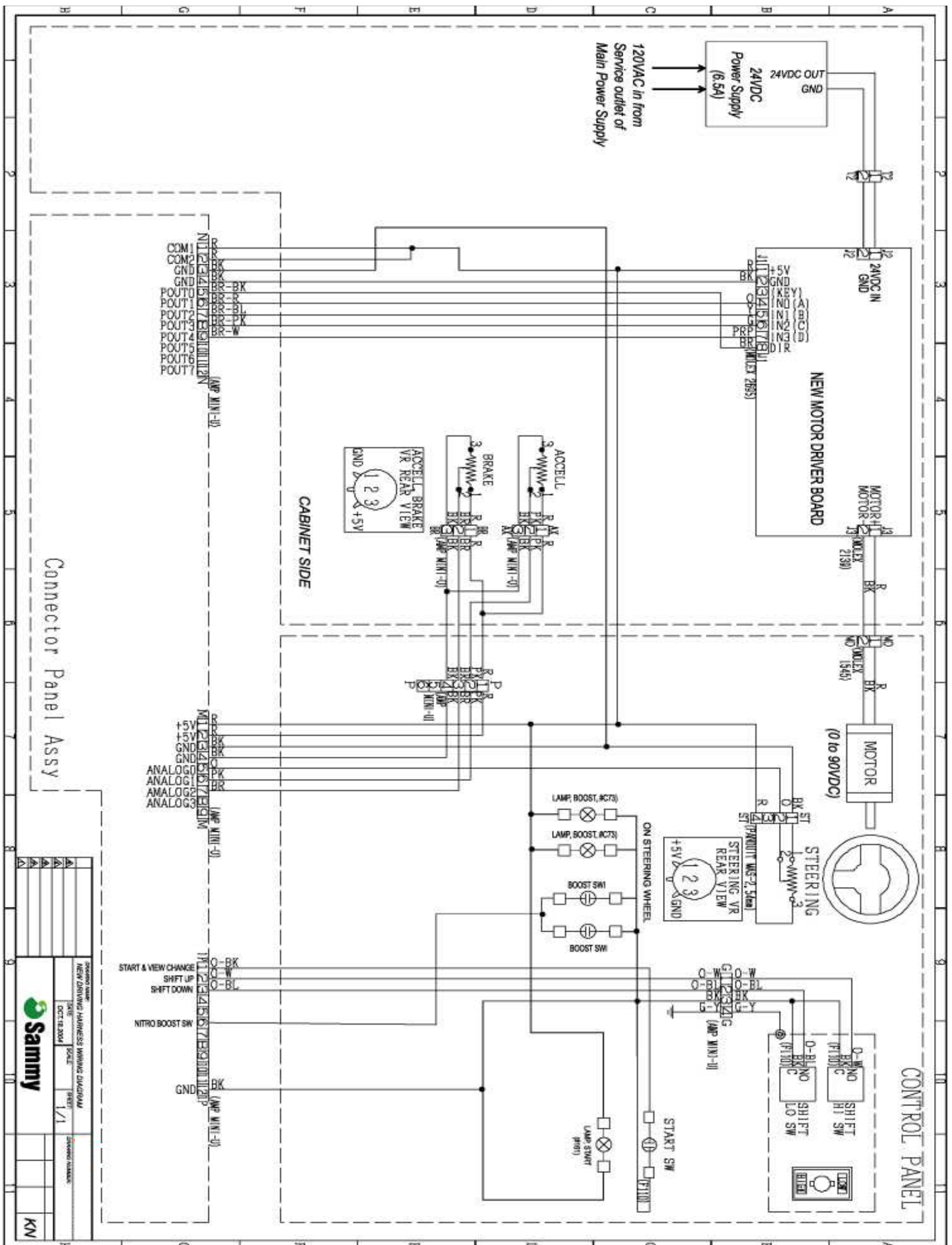

Connector Panel Assy

CONTROL PANEL

NEW MOTOR DRIVER BOARD

CABINET SIDE

DRAWING NAME NEW DRAWING HARNISS WIRING DIAGRAM		SHEET 1/1		DRAWING NUMBER KN	
DATE OCT 18 2004	SCALE 1/1	SAMMY			