

420-7032-01UK  
1<sup>ST</sup> PRINTING



SEGA AMUSEMENTS EUROPE LIMITED

Suite 3a, Oaks House, 12/22 West Street, Epsom, Surrey.  
KT18 7RG. United Kingdom.  
Tel: +441372 731820. Fax: +441372 731849  
© SEGA



SERVICE MANUAL

**LINDBERGH™**  
R E D 

#### IMPORTANT

- Before using this product, read this manual carefully to understand the contents herein stated.
- After reading this manual, be sure to keep it near the product or in a convenient place for easy reference when necessary.

# TABLE OF CONTENTS

BEFORE USING THE PRODUCT, BE SURE TO READ THE FOLLOWING:  
TABLE OF CONTENTS

INTRODUCTION .....	1
<b>1</b> HANDLING PRECAUTIONS .....	3
<b>2</b> LINDBERGH RED SPECIFICATIONS .....	4
2-1 CABINET .....	4
2-2 PARTS DETAILS .....	5
<b>3</b> LINDBERGH RED COMPONENTS .....	9
<b>4</b> SYSTEM TEST MODE .....	10
<b>5</b> ERROR CODES DISPLAY .....	24
<b>6</b> REPLACING THE BUTTON BATTERIES .....	28

## **(1) Use of GPL/LGPL software**

This product uses GPL/LGPL software.

This means that customers who purchase this product can freely obtain, alter and pass-on the source code for this software (hereafter referred to as “the source code”).

Downloaded this software is an indication of the customer’s agreement to the GPL/LGPL contract of use and thus the download and all subsequent use of the source code is the full responsibility of the customer.

Furthermore this source code and the download service are provided totally as-is, with no guarantees of effectiveness, completeness, usefulness or reliability, and our company offers no support concerning this source code.

### **GPL/LGPL Contract Site**

URL: <http://www.fsf.org/licenses/gpl.html>

URL: <http://www.fsf.org/licenses/lgpl.html>

Customers using this product who wish to obtain this source code should enter the following password on the website below to download it.

URL: <http://amproduct-softlicense.sega.jp/>

ID: amsoftwebdl

Password: segaamhd1

## **(2) Licensed Software Other Than GPL/LGPL**

At the web site given above, the Company gives notice of information on licensed software other than GPL/LGPL based on stipulations by the copyright holders. Please note, however, that the Company cannot answer inquiries pertaining to this software.

# INTRODUCTION

This manual is intended to provide detailed descriptions together with all the necessary information covering the general operation of electronic assemblies, electro-mechanicals, servicing control, spare parts, etc. for the product, "**LINDBERGH RED.**"

This manual is intended for the owners, personnel and managers in charge of operation of the product. Operate the product after carefully reading and sufficiently understanding the instructions.

In the unlikely event that the product does not function correctly, **DO NOT** allow anyone other than a technician to touch the internal system. Turn off power to the machine, making sure to unplug the electrical cord from the outlet, and contact the office listed in the manuals for each game or the point-of-purchase for this product.

Use of this product is unlikely to cause physical injuries or damages to property. However, points that require special attention are indicated by thick underlining, the word "IMPORTANT" and the symbol below.



**Indicates important information that, if ignored, will result in the mishandling of the product and cause faulty operation and damage to the product.**

## **SEGA AMUSEMENTS EUROPE, LTD.**

Suite 3a, Oaks House 12-22, West Street, Epsom, Surrey, KT18 7RG, United Kingdom

Telephone: +44 (0) 1372 731820    Facsimile: +44 (0) 1372 731849  
e-mail: [mailbox@sega.co.uk](mailto:mailbox@sega.co.uk)    <http://www.sega-amusements.co.uk>

## Definition of 'Site Maintenance Personnel or Other Qualified Individuals'

### **WARNING**

**Procedures not described in this manual or marked as 'to be carried out by site maintenance personnel or other qualified professionals' should not be carried out by personnel without the necessary skill or technology. Work carried out by unqualified persons may cause serious accidents, including electrocution.**

Parts replacement, maintenance inspections and troubleshooting should be carried out by site maintenance personnel or other qualified professionals. This manual includes directions that potentially dangerous procedures should only be carried out by professionals with the appropriate specialized knowledge.

The 'site maintenance personnel or other qualified professionals' mentioned in this manual are defined as follows:

#### **Site maintenance personnel:**

Persons with experience in maintaining amusement equipment, vending machines, etc., working under the supervision of the owner/operator of this product to maintain machines within amusement facilities or similar premises by carrying out everyday procedures such as assembly, maintenance inspections, and replacement of units/expendable parts.

#### **Activities to be carried out by site maintenance personnel:**

Amusement equipment/vending machine assembly, maintenance inspection and replacement of units/expendable parts.

#### **Other qualified professionals:**

Persons employed by amusement equipment manufacturers, involved in design, production, testing or maintenance of amusement equipment. Should have graduated from technical school or hold similar qualifications in electrician/electronics/mechanical engineering.

#### **Activities to be carried out by other qualified professionals:**

Amusement equipment/vending machine assembly, repair/adjustment of electrical/electronic/mechanical parts.

# 1 HANDLING PRECAUTIONS

## WARNING

- To prevent electric shock or IC Board malfunctioning, be sure to turn off the power for the cabinet when installing or removing the IC Board.
- Extraneous matter such as dust on the IC Board can cause the IC Board to generate heat and result in a fire due to short circuit, etc. Ensure the IC Board surfaces are always kept clean.
- Keep the IC board well cooled. The LINDBERGH RED board case is provided with ventilating fans. Do not block the air outlets of these fans. Also do not place anything closely to the LINDBERGH RED board case. Failure to observe these instructions may cause an overheating and fire.
- Use the LINDBERGH RED board with the SEGA specified cabinet and the power cable. Using it with the non-specified cabinet or the power cable may cause an overheating and fire.

## IMPORTANT

- Be sure to connect the IC Board and connectors completely. Insufficient insertion can damage IC Board, etc.
- For the IC Board circuit inspection, only the use of Logic Tester is permitted. The use of ordinary testers is not permitted as these can damage the IC Board.
- Do not subject the IC Board to static electricity when installing the IC Board in the cabinet or when connecting wire harness connectors to the IC Board.
- When soldering buttons, etc. to the wire harnesses, be sure to remove the wire harnesses from the IC Board so as not to subject the IC Board to heat.
- Using LINDBERGH RED without the Shield Case can cause electric wave trouble. Be sure to use LINDBERGH RED together with the accessory Shield Case.
- Some parts are the ones designed and manufactured not specifically for this game machine. The manufacturers may discontinue, or change the specifications of, such general-purpose parts. If this is the case, Sega cannot repair or replace a failed game machine whether or not a warranty period has expired.

## 2 LINDBERGH RED SPECIFICATIONS

### 2-1 CABINET

- Use the LINDBERGH RED board with the SEGA specified cabinet.
- When using the NAOMI CABINET, NET CITY, NEW NET CITY or BLAST CITY cabinets, you must acquire the correct kits, including the special power supply, and modify the cabinet correctly for LINDBERGH RED use.

Cabinet	Required Kit
NAOMI CABINET	NAOMI NET CITY series power supply modification kit (XKT-1516-EX1)
	FAN motor kit (XKT-0856)
NET CITY	NAOMI NET CITY series power supply modification kit (XKT-1516-EX1)
NEW NET CITY	NAOMI NET CITY series power supply modification kit (XKT-1516-EX1)
BLAST CITY	BLAST CITY series power supply modification kit (XKT-1516-01-EX1) <Others>
	BLAST CITY series power supply modification kit (XKT-1516-01-EX2) <Taiwan>

*NOTE: The contents herein described are subject to change without notice.*

## 2-2 PARTS DETAILS

### BOARD CASE

- (1) Shield case
- (2) Intake vent (Do not block or cover.)
- (3) Exhaust vent (Do not block or cover.)
- (4) Board number
- (5) Board serial number

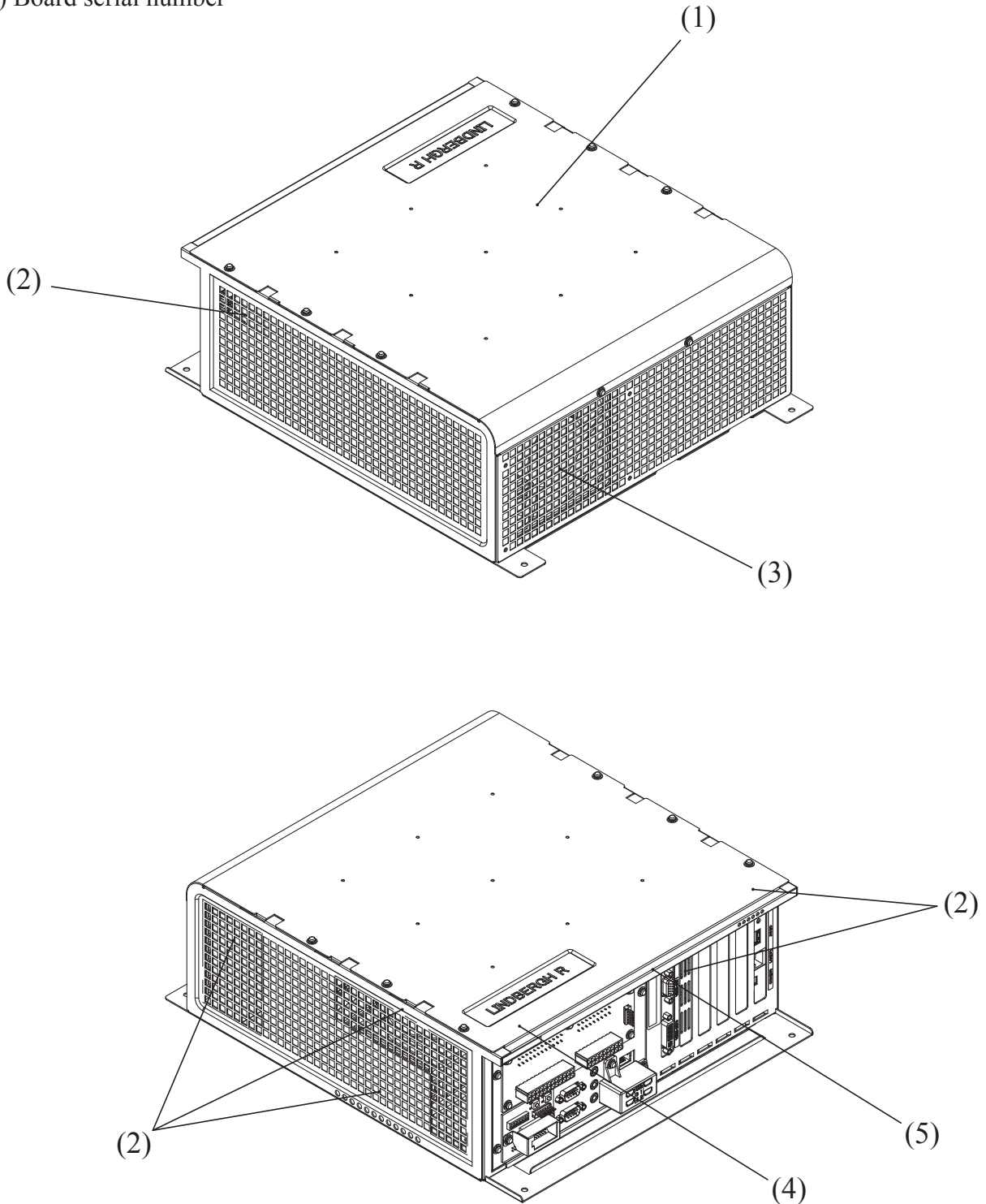



## CONNECTORS AND SWITCHES

### **WARNING**

Do not connect components to (6) JVS I/O or (8) Serial port 3 that are not designated by SEGA. Connecting unspecified components could cause an accident such as an electric shock or fire.

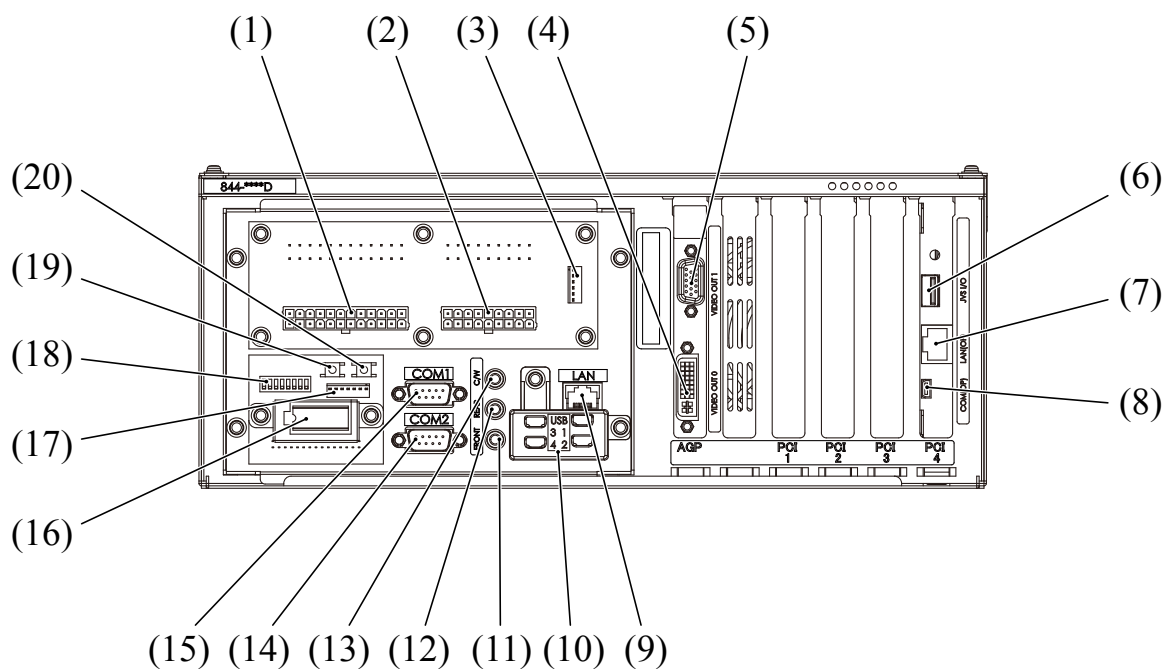

- (1) Power connector 1
- (2) Power connector 2
- (3) DVD Drive power connector
- (4) Video output 0
- (5) Video output 1
- (6) JVS I/O
- (7) LAN port 2
- (8) Serial port 3
- (9) LAN port 1
- (10) USB Port 1 - 4 (USB Mini A)
- (11) Front lineout
- (12) Rear lineout
- (13) Centre/Woofers lineout
- (14) Serial port 2 (RS232C)
- (15) Serial port 1 (RS232C)
- (16) Key chip socket
- (17) Serial port 2 (MIDI) ...used instead of (14) Serial port 2 (RS232C)
- (18) DIP SW (Dip switches)
- (19) Service button
- (20) Test button

**(1) Power Connector 1**

Terminal No.	Signal Name	Terminal No.	Signal Name
1	+3.3V	13	+3.3V
2	+3.3V	14	N.C
3	GND	15	GND
4	+5V	16	PS_ON#
5	GND	17	GND
6	+5V	18	GND
7	GND	19	GND
8	PWR_ON	20	NC
9	+5SB	21	+5V
10	+12V	22	+5V
11	+12V	23	+5V
12	+3.3V	24	GND

**(2) Power Connector 2**

Terminal No.	Signal Name	Terminal No.	Signal Name
1	+12V	10	GND
2	+12V	11	GND
3	+5V	12	GND
4	+12V	13	GND
5	+5V	14	GND
6	+12V	15	GND
7	+5V	16	GND
8	+12V	17	GND
9	3.3VRS(SENCE)	18	+3.3V

**(3) DVD DRIVE Power Connector**

Terminal No.	Signal Name
1	+12V
2	+12V
3	+5V
4	+5V
5	GND
6	GND

**(14) Serial port 2 (RS232C)**

**(15) Serial port 1 (RS232C)**

Terminal No.	Signal Name
1	DCD
2	RXD
3	TXD
4	DTR
5	GND
6	DSR
7	RTS
8	CTS
9	RI

**(18) DIP SW**

No. 1, No. 2: Use differs depending on game software. Set according to the service manual provided with the game software itself.

No. 3: Changes the facing of the monitor. Use differs depending on game software. Set according to the service manual provided with the game software itself. If no specific directions are given set to horizontal display (OFF).

- OFF: Horizontal display
- ON: Vertical display

No. 4, No. 5 and No. 6: Set the resolution of the video output.

Resolution	No. 4	No. 5	No. 6
640 x 480	OFF	OFF	OFF
800 x 600	OFF	OFF	ON
1024 x 768	OFF	ON	OFF
1280 x 1024	OFF	ON	ON
800 x 480	ON	OFF	OFF
1024 x 600	ON	OFF	ON
1280 x 768	ON	ON	OFF
1360 x 768	ON	ON	ON

No. 7, No. 8: Use differs depending on game software. Set according to the service manual provided with the game software itself.

The factory settings when a game board (LINDBERGH RED) is purchased as a stand-alone unit.

No. 1	No. 2	No. 3	No. 4	No. 5	No. 6	No. 7	No. 8
OFF	OFF	OFF	OFF	OFF	OFF	OFF	ON

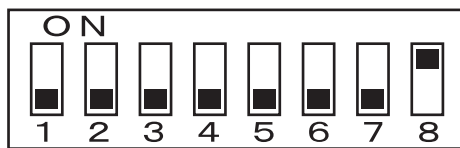

### 3 LINDBERGH RED COMPONENTS

Confirm that the accessories listed in the table below are present when setting up the product.

3 TABLE 01 ACCESSORIES

DESCRIPTION	SERVICE MANUAL
Part No. (Qty)	420-7032-01 (1)
Notes	This manual
Figures	
Parts not labeled with part numbers are as yet unregistered or cannot be registered. Be sure to handle all parts with care, as some parts are not available for purchase separately.	

TAPPING SCREW

011-P00412 (4)

Used for securing the LINDBERGH

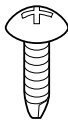

LINDBERGH RED BOARD

845-0001D-01 (1): USA

845-0001D-02 (1): OTHERS

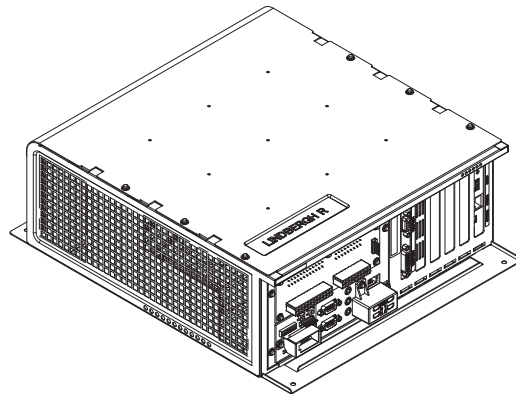

## 4 SYSTEM TEST MODE

### STOP IMPORTANT

The details of changes to Test Mode settings are saved when you exit from Test Mode by selecting EXIT from the SYSTEM TEST MENU. Be careful because if the power is turned off before that point, changes to the settings will be lost.

#### SYSTEM TEST MENU

System Test Mode can be used to check the information or the operation of the LINDBERGH RED board, adjust Monitor color, and perform coin/credit settings.

- 1 Press the TEST Button after powering on the unit to display the following SYSTEM TEST MENU.

SYSTEM TEST MENU	
SYSTEM INFORMATION .....	a
STORAGE INFORMATION .....	b
JVS TEST .....	c
MONITOR TEST .....	d
SPEAKER TEST .....	e
COIN ASSIGNMENTS .....	f
CLOCK SETTING .....	g
NETWORK SETTING .....	h
GAME TEST MODE .....	i
-> EXIT	
SELECT WITH SERVICE AND PRESS TEST	

- 2 Use the SERVICE Button to move the cursor to the desired test item. Press the TEST Button to enter the selected item. After selecting an item, read the explanations below regarding operation.
- 3 Press the TEST Button when GAME TEST MODE is selected to change to the Test Menu specific to the game.
- 4 After the test is complete, move the cursor to EXIT and press the TEST Button to return to the Game Advertisement screen.

## a. SYSTEM INFORMATION

The SYSTEM INFORMATION screen displays system information.

```

                                SYSTEM INFORMATION

MOTHER BOARD
SERIAL NO.           AAH*_*****
KERNEL VERSION      *.*_*_*_*_*_*_*_*
BOOT VERSION        *.*(BUILD ****)
REGION              **
MODEL TYPE          *
MEMORY SIZE         *****
CPU MODEL           *.*_*_*
STORAGE DEVICE
STORAGE SIZE        ***** MB
BASE BOARD
SERIAL NO.          A80*_*****
FIRM VERSION        *.*_*_*
GRAPHIC BOARD
DEVICE ID           *****
BIOS VERSION        *.*_*_*_*_*_*_*_*

                                PRESS TEST TO EXIT

```

The following information is displayed on this screen.

- MOTHER BOARD
  - SERIAL NO.: The serial number of the game board.
  - KERNEL VERSION: The system's OS version.
  - BOOT VERSION: The boot program version.
  - REGION: The region setting.
  - MODEL TYPE: The model type.
  - MEMORY SIZE: The onboard memory size.
  - CPU MODEL: The CPU model.
- STORAGE DEVICE
  - STORAGE SIZE: The total capacity of the program installer device.
- BASE BOARD
  - SERIAL NO.: The serial number.
  - FIRM VERSION: The firmware version.
- GRAPHIC BOARD
  - DEVICE ID: The graphic board's ID.
  - BIOS VERSION: The VBIOS version.

Press the TEST Button to return to the System Test Menu screen.

## b. STORAGE INFORMATION

The STORAGE INFORMATION screen displays information on the game contained within the program installer device. This screen is also used when uninstalling the game contained within the program installer device.

Until preparations to launch the game are complete, a “now checking” screen will be displayed and uninstall cannot be performed. If the program installer device does not contain any game data, the game information will be displayed in grey and uninstall cannot be performed.

NOTE: If an uninstall is performed, an install will then have to be performed before the game board can be used again. Do not needlessly perform an uninstall.

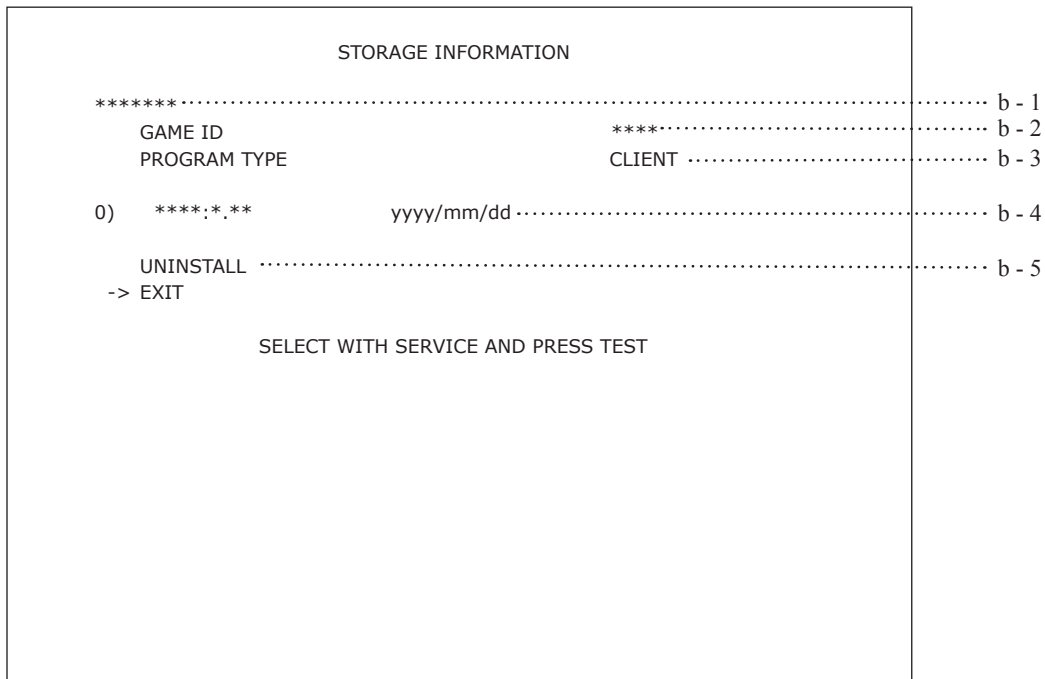

The following information is displayed on this screen.

b - 1. GAME TITLE

b - 2. GAME ID

b - 3. PROGRAM TYPE

b - 4. INSTALLED IMAGE LIST

- IMAGE NUMBER
- GAME ID
- VERSION
- DATE OF RELEASE

b - 5. UNINSTALL

When preparations to launch the game are complete, it is possible to uninstall the game stored in the program install device. Select UNINSTALL and then select “YES” to uninstall all game programs stored in the program install device. Performing this operation will also mean that GAME TEST will disappear from the main menu.

Move the cursor to EXIT and press the TEST Button to return to the System Test Menu screen.

### c. JVS TEST

The JVS TEST screen displays information on the connected JVS I/O boards.  
(The display screen varies in the connected I/O board.)

Select INPUT TEST to display input data for the currently displayed JVS I/O board. (See “c-1 JVS INPUT TEST”)

Select NEXT NODE to display information on the next NODE.

If no JVS I/O boards are connected, the message “NO JVS NODE” will be displayed

```

                                JVS TEST
INPUT TEST
NEXT NODE
-> EXIT
NODE                            1/*
NAME                            SEGA ENTERPRISES,LTD.
                                I/O BD JVS
                                837-13551
                                Ver1.00
CMD VER                          1.1
JVS VER                          2.0
COM VER                          1.0
SWITCH                          2 PLAYER(S) 13 BITS
COIN                             2 SLOT(S)
ANALOG                          8 CH
ROTARY                          0 CH
KEYCODE                          0
SCREEN                          X:0 Y:0 CH:0
CARD                             0 SLOT(S)
HOPPER OUT                       0 CH
DRIVER OUT                       6 CH
ANALOG OUT                       0 CH
CHARACTER                       CHARA:0 LINE:0
BACKUP                           0

SELECT WITH SERVICE AND PRESS TEST

```

The following information is displayed on this screen.

NODE: The currently displayed NODE number and the total number of connected NODEs  
NAME: Name of the connected I/O board, etc.  
CMD VER: Command format version  
JVS VER: JVS standard version  
COM VER: Communication version  
SWITCH: Number of players and number of IP switches  
COIN: Number of coin slots  
ANALOG: Number of analog channels  
ROTARY: Number of encoders  
KEYCODE: Keycode input active/inactive  
SCREEN: Screen position input (X axis, Y axis, number of channels)  
CARD: Number of card slots  
HOPPER OUT: Number of hoppers  
DRIVER OUT: Number of standard output drivers  
ANALOG OUT: Number of analog output channels  
CHARACTER: Number of characters/lines displayed  
BACKUP: Backup present/absent

Move the cursor to EXIT and press the TEST Button to return to the System Test Menu screen.



### c - 1. JVS INPUT TEST

Use the JVS INPUT TEST to test the JVS input.

The hexadecimal input information from the JVS I/O board will be displayed in real time.

JVS TEST INPUT TEST	
NODE	1/*
SYSTEM	00
PLAYER 1	0000
PLAYER 2	0000
COIN 1	0000
COIN 2	0000
ANALOG 0	0000
ANALOG 1	0000
ANALOG 2	0000
ANALOG 3	0000
ANALOG 4	0000
ANALOG 5	0000
ANALOG 6	0000
ANALOG 7	0000

PRESS TEST AND SERVICE TO EXIT

The following information is displayed on this screen.

SYSTEM: System switch input data  
PLAYER: Player number and player switch input data  
COIN: Slot number and coin input data  
ANALOG: Channel number and analog input data

Press the SERVICE and TEST Buttons simultaneously to return to the JVS Test screen.

### d. MONITOR TEST

Use MONITOR TEST to check the output of the monitor.

Enter MONITOR TEST and the following color bars will be displayed.

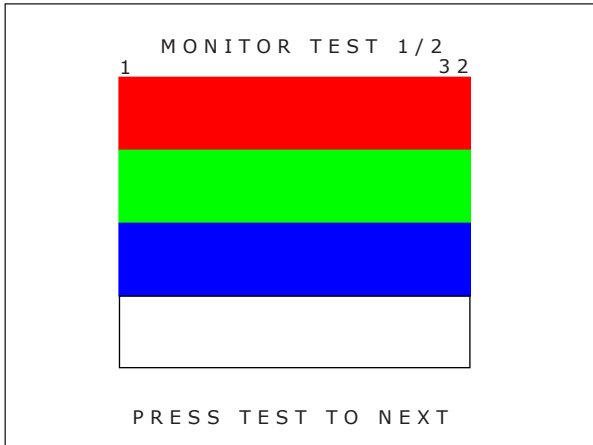

Press the TEST Button and the screen will change to the following cross-hatch screen.

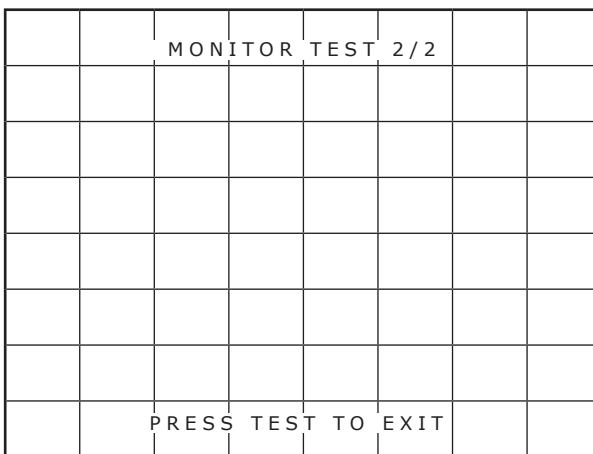

Press the TEST Button to return to the System Test Menu screen.

#### e. SPEAKER TEST

Use SPEAKER TEST to check the output of each speaker by having them each emit a test sound.

Select each speaker with the cursor and press the TEST Button to turn that speaker ON or OFF.

When set to ON a test sound will be emitted from that speaker.

It is possible to set multiple speakers to emit the test sound at the same time.

Some of these options may not be displayed depending on the cabinet being used.

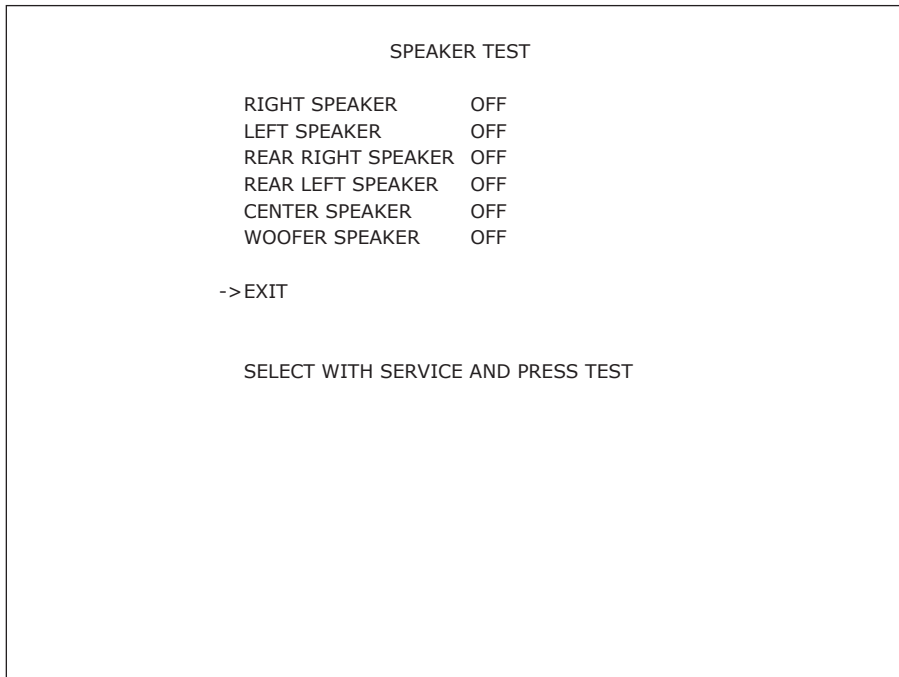

The speakers available to test are as follows.

RIGHT SPEAKER

LEFT SPEAKER

REAR RIGHT SPEAKER

REAR LEFT SPEAKER

CENTER SPEAKER

WOOFER SPEAKER

Move the cursor to EXIT and press the TEST Button to return to the System Test Menu screen.

**f. COIN ASSIGNMENTS**

Use COIN ASSIGNMENTS to alter the credit settings.

The game will award players the number of credits determined here. Settings will only be saved if they have been changed.

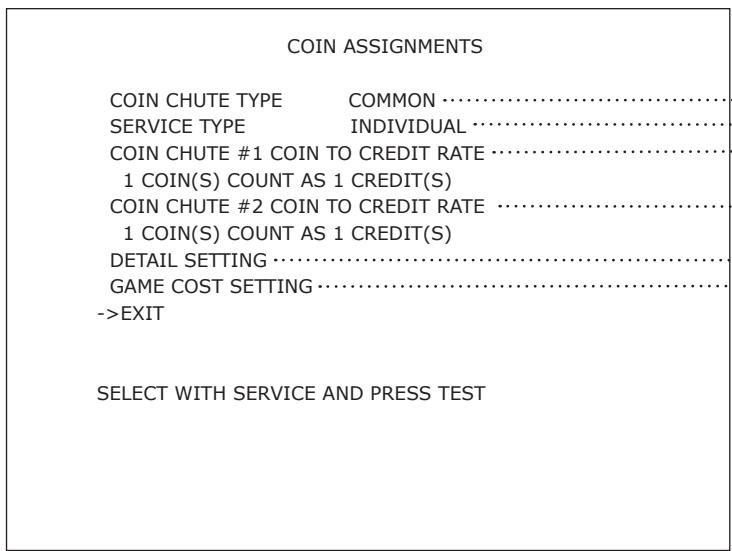

The following information is displayed on this screen.

**f - 1. COIN CHUTE TYPE**

COMMON	Allow all credits to be used by all players.
INDIVIDUAL	Treat each player's credits individually.

**f - 2. SERVICE TYPE (Service Button Type)**

COMMON	When the COIN CHUTE TYPE is set to COMMON, the number of credits available to all players will increase by 1.
	When the COIN CHUTE TYPE is set to INDIVIDUAL, each player's credits will increase by 1.
INDIVIDUAL	When the COIN CHUTE TYPE is set to COMMON, the number of credits available to all players will increase by 1.
	When the COIN CHUTE TYPE is set to INDIVIDUAL, the player corresponding to the SERVICE Button's credits will increase by 1.

**f - 3. COIN CHUTE #1 COIN TO CREDIT RATE (Coin and credit conversion rate 1)**

1 COIN(S) COUNT AS 1 CREDIT(S)	1 coin counts as 1 credit
2 COIN(S) COUNT AS 1 CREDIT(S)	2 coins count as 1 credit
3 COIN(S) COUNT AS 1 CREDIT(S)	3 coins count as 1 credit
4 COIN(S) COUNT AS 1 CREDIT(S)	4 coins count as 1 credit
5 COIN(S) COUNT AS 1 CREDIT(S)	5 coins count as 1 credit
1 COIN(S) COUNT AS 2 CREDIT(S)	1 coin counts as 2 credits
1 COIN(S) COUNT AS 3 CREDIT(S)	1 coin counts as 3 credits
1 COIN(S) COUNT AS 4 CREDIT(S)	1 coin counts as 4 credits
1 COIN(S) COUNT AS 5 CREDIT(S)	1 coin counts as 5 credits
FREE PLAY	Free play (no coins required)
DETAIL SETTING	More detailed settings

**f - 4. COIN CHUTE #2 COIN TO CREDIT RATE (Coin and credit conversion rate 2)**

(Can only be set when the COIN CHUTE TYPE is set to COMMON and the COIN setting for the COIN CHUTE #1 COIN TO CREDIT RATE is set to “1”)

**f - 5. DETAIL SETTING**

The COIN ASSIGNMENTS DETAIL SETTING screen allows more detailed settings that cannot be performed on the Coin Setting screen to be performed.

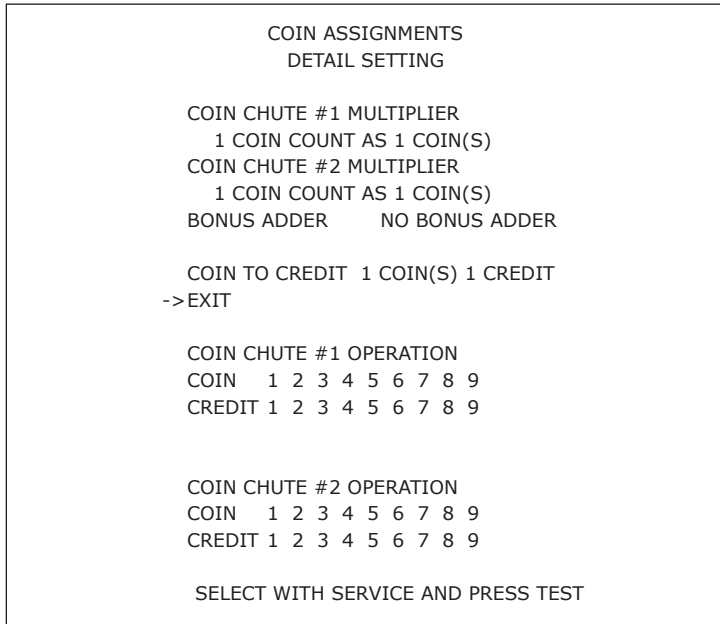

The following information is displayed on this screen.

COIN CHUTE #1 MULTIPLIER: Coin conversion rate for #1 (How many coins 1 inserted coin counts for)

COIN CHUTE #2 MULTIPLIER: Coin conversion rate for #2 (How many coins 1 inserted coin counts for)

BONUS ADDER: Use of a bonus coin

NO BONUS ADDER	No bonus coin given
2 COINS GIVE 1 EXTRA COIN	2 coins inserted successively award 1 bonus coin
3 COINS GIVE 1 EXTRA COIN	3 coins inserted successively award 1 bonus coin
4 COINS GIVE 1 EXTRA COIN	4 coins inserted successively award 1 bonus coin
5 COINS GIVE 1 EXTRA COIN	5 coins inserted successively award 1 bonus coin
6 COINS GIVE 1 EXTRA COIN	6 coins inserted successively award 1 bonus coin
7 COINS GIVE 1 EXTRA COIN	7 coins inserted successively award 1 bonus coin
8 COINS GIVE 1 EXTRA COIN	8 coins inserted successively award 1 bonus coin
9 COINS GIVE 1 EXTRA COIN	9 coins inserted successively award 1 bonus coin

COIN TO CREDIT: The number of coins to number of credits conversion rate

Move the cursor to EXIT and press the TEST Button to return to the Coin Assignments screen.

#### f - 6. GAME COST SETTING

Use the COIN ASSIGNMENTS GAME COST SETTING screen to set the cost (number of required credits) that the game program will use to determine if there are enough credits to play the game.

A total of 8 game costs can be defined. The game cost is defined by the BOOT ID, and when the second boot recognizes the game, the game cost defined by the BOOT ID will be displayed.

If the game is not recognized, the default game cost will be displayed.

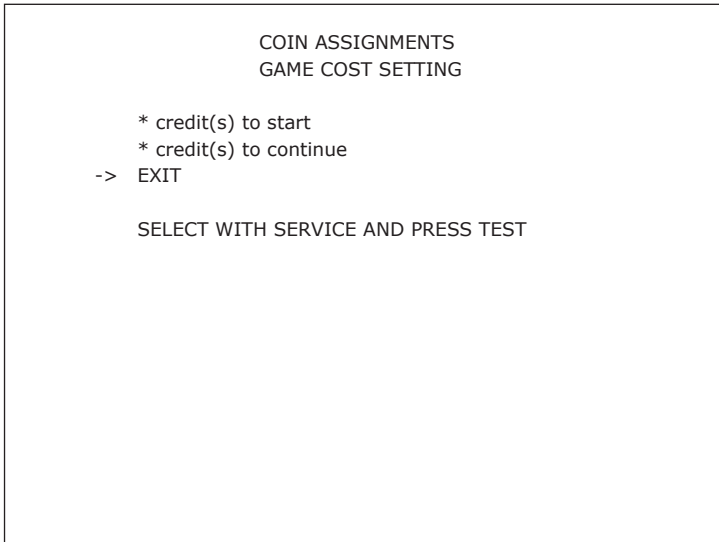

Move the cursor to EXIT and press the TEST Button to return to the Coin Assignments screen.

## g. CLOCK SETTING

Use CLOCK SETTING to set the date and time.

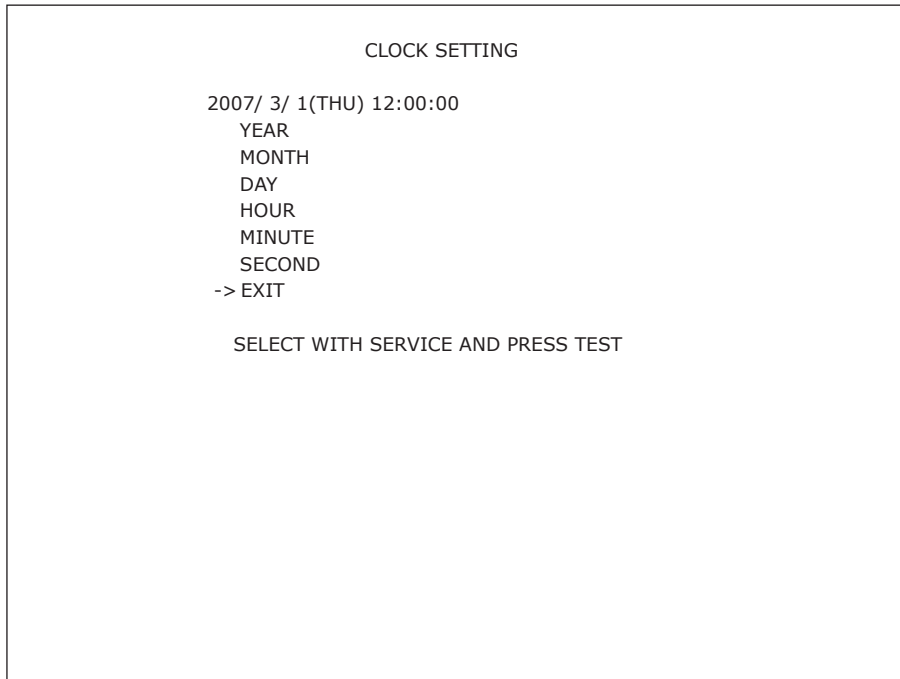

Use the SERVICE Button to move the cursor to the category that you wish to change and press the TEST Button to increase that value. Holding the TEST Button down will make the value continuously increase.

Move the cursor to EXIT and press the TEST Button to return to the System Test Menu screen.

### h. NETWORK SETTING

Use NETWORK SETTING to determine network settings or to test the network.  
There is no need to alter these settings for a game that does not use a network.

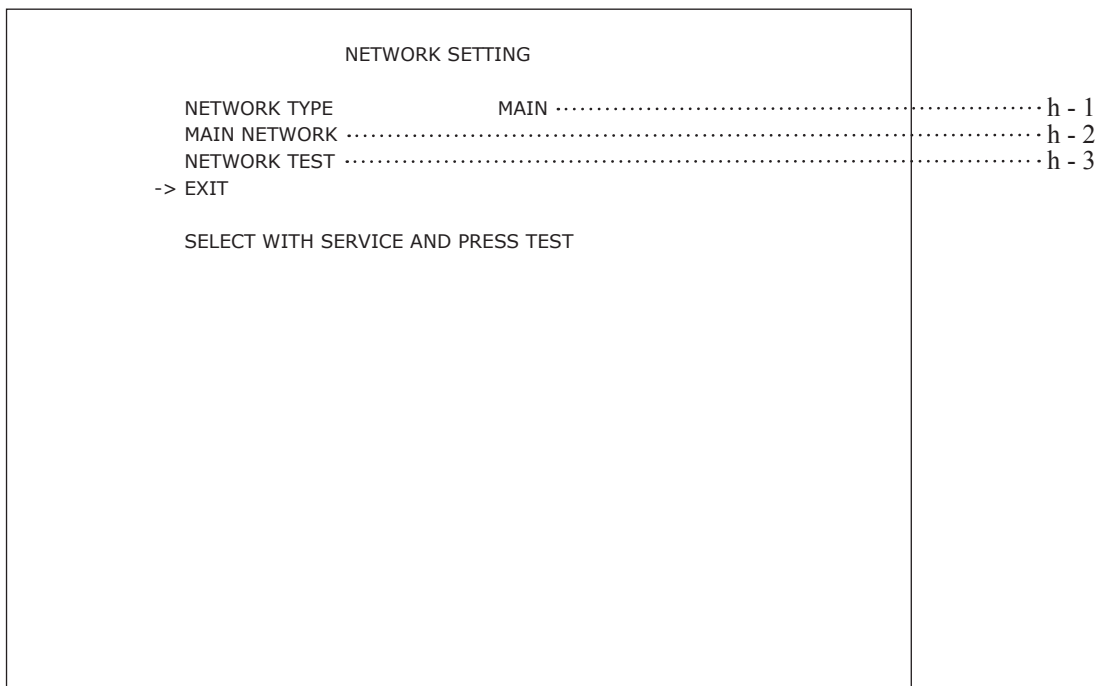

The following information is displayed on this screen.

- h - 1. NETWORK TYPE: MAIN (Sets the type of network to use.)
- h - 2. MAIN NETWORK: Sets the LAN port 1.
- h - 3. NETWORK TEST: Performs a network test.

Move the cursor to EXIT and press the TEST Button to return to the System Test Menu screen.



## h-2. MAIN NETWORK

Select MAIN NETWORK on the NETWORK SETTING (Setting Menu) and the following screen will be displayed.

NETWORK SETTING

MAC ADDRESS    \*\*.\*.\*.\*.\*.\*.\*.\*

DHCP            \*\*\*\*\*

IP ADDRESS     \*.\*.\*.\*.\*.\*.\*

SUBNET MASK   \*.\*.\*.\*.\*.\*.\*

GATEWAY       \*.\*.\*.\*.\*.\*.\*

PRIMARY DNS    \*.\*.\*.\*.\*.\*.\*

SECONDARY DNS \*.\*.\*.\*.\*.\*.\*

-> EXIT

SELECT WITH SERVICE AND PRESS TEST

- **MAC ADDRESS**  
The individual ID number assigned to each device using the Ethernet.
- **DHCP**  
Set automatic acquisition of network settings.  
ENABLE: Acquire network settings automatically.  
DISABLE: Input network settings manually.
- **IP ADDRESS**  
A setting required for the network.  
After setting the numbers, select SET and press the TEST Button to save the setting.  
You cannot select DHCP when ENABLE is selected.
- **SUBNET MASK**  
A setting required for the network.  
After setting the numbers, select SET and press the TEST Button to save the setting.  
You cannot select DHCP when ENABLE is selected.
- **GATEWAY**  
A setting required for the network. See the manual supplied with each game software for the correct setting.  
After setting the numbers, select SET and press the TEST Button to save the setting.  
You cannot select DHCP when ENABLE is selected.
- **PRIMARY DNS**  
A setting required for the network. See the manual supplied with each game software for the correct setting.  
After setting the numbers, select SET and press the TEST Button to save the setting.  
You cannot select DHCP when ENABLE is selected.
- **SECONDARY DNS**  
A setting required for the network. See the manual supplied with each game software for the correct setting.  
After setting the numbers, select SET and press the TEST Button to save the setting.  
You cannot select DHCP when ENABLE is selected.

### h-3. NETWORK TEST

Check the network connection.

The test will begin as soon as this screen is displayed.

If the test ends successfully “GOOD” will be displayed. If the test is unsuccessful “BAD” will be displayed.

If connection is not permitted “N/A” will be displayed.

The results of the test may not be correct immediately after changing the network settings. After exiting the test mode, restart the cabinet and try again.

```
NETWORK TEST

STATUS      ****
CHECKING    ***%

DHCP ----- ****
LOOPBACK -- ****
GATEWAY --- ****
SERVER ---- ****

PRESS TEST TO EXIT
```

### i. GAME TEST MODE

Opens the Game Test Mode, allowing game specific settings and tests to be performed.

This option will be displayed in grey until preparations are complete. Select the Game Test Mode option then perform the exit to begin the game test.

## 5 ERROR CODES DISPLAY

### WARNING

- If an error code is displayed get on-site maintenance personnel or other qualified professional to look at it. An unqualified person attempting to resolve an error code problem may lead to electric shock, short circuit and risk of fire.  
If no on-site maintenance personnel or qualified professional is available immediately turn off the power and contact the customer services in this manual or your supplier.
- If a problem not described in this manual occurs, or the resolution to a problem described in this manual is not effective, do not make further attempts to resolve the problem yourself. Immediately turn off the power and contact the customer services in this manual or your supplier. Any unguided attempts to solve such problems may lead to a serious accident.

### IMPORTANT

If an error number or message not listed below appears, cease using the product immediately and send the LINDBERGH RED board in for repairs.

The LINDBERGH RED board is equipped to display various errors on-screen to help solve any problems. If an error is displayed the game cannot be used. Use the following table of causes and resolutions to solve the problem.

#### Error 1

DISPLAY	Game Program Not Found.
CAUSE	The key chip is not connected.
COUNTERMEASURES	Check that the key chip is connected correctly.

#### Error 2

DISPLAY	Game Program Not Available.
CAUSE	The key chip is not supported.
COUNTERMEASURES	Check that the key chip from a different system is not inserted. If that doesn't fix the problem, send the LINDBERGH RED board in for repair with the key chip still in place.

#### Error 3

DISPLAY	Graphic Card Not Working.
CAUSE	The LINDBERGH RED board's graphic card cannot be found.
COUNTERMEASURES	Send the LINDBERGH RED board in for repair with the key chip still in place.

#### Error 5

DISPLAY	Wrong Region.
CAUSE	The game is for a foreign region.
COUNTERMEASURES	Use a domestic game.

#### Error 6

DISPLAY	I/O Device Not Found.
CAUSE	The I/O board inside the LINDBERGH RED cannot be found.
COUNTERMEASURES	Send the LINDBERGH RED board in for repair with the key chip still in place.

**Error 7**

DISPLAY	Graphic Card Not Found.
CAUSE	The game disk does not support the LINDBERGH RED, or the LINDBERGH RED board's graphics card cannot be found.
COUNTERMEASURES	Verify that the game disk is compatible with the LINDBERGH RED. If it is, send the LINDBERGH RED board in for repair with the key chip still in place.

**Error 9**

DISPLAY	System Memory Not Enough.
CAUSE	The LINDBERGH RED board does not have enough memory.
COUNTERMEASURES	Send the LINDBERGH RED board in for repair with the key chip still in place.

**Error 10**

DISPLAY	Unexpected Game Program Failure.
CAUSE	The game program crashed due to an unexpected error.
COUNTERMEASURES	Turn the power off and then restart.

**Error 11**

DISPLAY	JVS I/O board is not connected to main board.
CAUSE	(1) The I/O board is not connected. (2) Unreliable connection between the main board and the I/O board.
COUNTERMEASURES	(1) Connect the I/O board to the main board. Verify that the power cable is connected to I/O board. (2) Reconnect or replace the JVS cable that connects the I/O board to the main board.

**Error 12**

DISPLAY	JVS I/O board does not fulfill the game spec.
CAUSE	The correct I/O board is not connected.
COUNTERMEASURES	Use an I/O board that provides the proper input/output for the game.

**Error 15**

DISPLAY	Game Program Not Found.
CAUSE	The key chip is not connected.
COUNTERMEASURES	Check that the key chip is connected correctly. Check that the key chip from a different system is not inserted.

**Error 21**

DISPLAY	Game Program Not Found on Game Disk.
CAUSE	There is no program image on the game disk.
COUNTERMEASURES	Check that a game disk corresponding to the key chip is inserted into the drive.

**Error 22**

DISPLAY	Game Program Not Found on Device.
CAUSE	There is no game image on the game installer device.
COUNTERMEASURES	Perform a reinstall from the game disk.

**Error 24**

DISPLAY	DVD Drive Not Found.
CAUSE	The DVD drive cannot be found.
COUNTERMEASURES	Connect the DVD drive.

**Error 25**

DISPLAY	Game Disk Not Found.
CAUSE	The game disk cannot be found.
COUNTERMEASURES	Insert the game disk.

**Error 26**

DISPLAY	Storage Device Not Found.
CAUSE	The program installer device cannot be found.
COUNTERMEASURES	Send the LINDBERGH RED board in for repair with the key chip still in place.

**Error 27**

DISPLAY	Storage Device is Not Acceptable.
CAUSE	The program installer device does not have enough space.
COUNTERMEASURES	Send the LINDBERGH RED board in for repair with the key chip still in place.

**Error 28**

DISPLAY	This Game Disk is Not Acceptable.
CAUSE	The game disk cannot be read correctly.
COUNTERMEASURES	Exchange the game disk for a proper game disk. Check that the game disk is not scratched, damaged or dirty.

**Error 29**

DISPLAY	Cannot Control DVD Drive.
CAUSE	The DVD drive cannot be controlled.
COUNTERMEASURES	The DVD drive may be damaged.

**Error 31**

DISPLAY	Storage Device Not Enough.
CAUSE	The program installer device does not have enough space.
COUNTERMEASURES	Send the LINDBERGH RED board in for repair with the key chip still in place.

**Error 32**

DISPLAY	Installing Game Program Failed.
CAUSE	Transfer of the program failed.
COUNTERMEASURES	Check that the DVD drive is connected correctly. Check that the game disk is not scratched, damaged or dirty.

**Error 33**

DISPLAY	Storage Device is Not Acceptable.
CAUSE	The program installer device cannot be found.
COUNTERMEASURES	Send the LINDBERGH RED board in for repair with the key chip still in place.

**Error 34**

DISPLAY	Storage Device Not Found.
CAUSE	The program installer device cannot be found.
COUNTERMEASURES	Send the LINDBERGH RED board in for repair with the key chip still in place.

**Error 35**

DISPLAY	Storage Device is Not Acceptable.
CAUSE	The program installer device does not have enough space.
COUNTERMEASURES	Send the LINDBERGH RED board in for repair with the key chip still in place.

**Error 36**

DISPLAY	Storage Device May be Broken.
CAUSE	The program installer device is broken.
COUNTERMEASURES	Send the LINDBERGH RED board in for repair with the key chip still in place.

**Error 37**

DISPLAY	Verifying Game Program Failed.
CAUSE	The program image is unverified due to the program image not existing on the game disk or server.
COUNTERMEASURES	Check that the correct game disk is inserted.

**Error 41**

DISPLAY	Server Not Respond.
CAUSE	The server is not responding.
COUNTERMEASURES	Check the network settings. Set IP Address and other settings. Check that the network cable has not been pulled out.

**Error 42**

DISPLAY	Server Mount Failed.
CAUSE	The server directory is could not be reached.
COUNTERMEASURES	Check the network settings. Set IP Address and other settings. Check that the network cable has not been pulled out.

**Error 43**

DISPLAY	IP Address Not Assigned.
CAUSE	An IP Address could not be obtained from the DHCP server.
COUNTERMEASURES	Check the network settings. Check that the network cable has not been pulled out. Check that the DHCP server is running.

**Error 44**

DISPLAY	Game Program Not Found on Server.
CAUSE	No program image on the network server.
COUNTERMEASURES	Check that the game title, place on the network server, and the key chip correspond to each other.

**Error 45**

DISPLAY	Server Not Respond.
CAUSE	A communications error occurred while the program image was being sent through the network server.
COUNTERMEASURES	Check the network connection, then restart.

**Caution 51**

DISPLAY	Wrong Resolution Setting.
CAUSE	The game does not support the current resolution settings.
COUNTERMEASURES	Change the DIP SW to the correct settings and restart.

**Caution 52**

DISPLAY	Wrong Horizontal/Vertical Setting.
CAUSE	The monitor horizontal/vertical settings are incorrect.
COUNTERMEASURES	Change the DIP SW to the correct settings and restart.

## 6 REPLACING THE BUTTON BATTERIES

### WARNING

- Make sure you do not damage the printed board and wires. Such damage can lead to electric shock, short circuit and fire hazard.
- To prevent overheating, explosion, or fire:
  - Do not recharge, disassemble, heat, incinerate, or short the battery.
  - Do not allow the battery to come into direct contact with metallic objects or other batteries.
  - To preserve the battery, wrap it in tape or other insulating material.
- Follow local regulations when disposing of the battery. Improper disposal can damage the environment.
- Even the site maintenance personnel or other qualified professionals must not perform replacement operations for parts not described in this manual. In the event that such work is required either contact the office listed in this manual or first confirm the procedure with the place or office of purchase. Failure to do so may lead to electric shock or short circuit.

### CAUTION

To avoid risk of malfunction and damage:

- Make sure the positive and negative ends are aligned correctly.
- Use only batteries approved for use with this unit.

### IMPORTANT

- The batteries in the LINDBERGH RED board can be used for approximately 5 years of standard usage. If the battery appears to require replacement sooner than 5 years it is more likely that an error has occurred with some other part of the board. Rather than exchanging the battery requesting repair of the board itself may be more appropriate.
- Do not touch any internal parts of the board case that are not designated by SEGA. Also, never perform modifications (removal, exchanging, or extension of parts, etc.) that are not designated by SEGA.

The button batteries that require replacement can be found on the main board and on the base board, inside the LINDBERGH RED board case.

**1** Remove the unit on which the LINDBERGH RED board is placed from the game cabinet. The LINDBERGH RED board must be removed still attached to the base (wooden shelf, etc.).

**2** Remove eight screws for the LINDBERGH RED board lid.

**3** Press on the front and back of the lid from above and slide toward the side with the fan, releasing the catches on the left and right sides. Remove the lid.

**4** The main board is the board on the bottom of the LINDBERGH RED board case. The button battery is location close to the fan.

**5** The base board is one of the board inserted vertically inside the LINDBERGH RED board case. Remove the screw holding it in place and lift the board directly upward to remove it. The button battery is on the upper part of the board.

- (1) SCREW (8), black / M3 x 8, w/flat & spring washers
- (2) Left (and right) side lid catches
- (3) Press here and slide toward fan
- (4) BUTTON BATTERY (BATTERY CR2032 1F MATSUSHITA) / 401-0054
- (5) SCREW (1), black/M3 x 8, w/flat & spring washers
- (6) BASE BOARD
- (7) BUTTON BATTERY (BATTERY CR2032 1F MATSUSHITA) / 401-0054

