

# BEFORE USING THE PRODUCT, BE SURE TO READ THE FOLLOWING:

## To maintain safety:

To ensure the safe operation of this product, be sure to read the following before usage. The following instructions are intended for the users, operators and the personnel in charge of the operation of the product. After carefully reading and sufficiently understanding the warning displays and cautions, handle the product appropriately. Be sure to keep this manual close to the product or in a convenient place for future reference.

Herein, explanations which require special attention are enclosed with dual lines. Depending on the potentially hazardous degrees, the terms of DANGER, WARNING, CAUTION, etc. are used. Be sure to understand the contents of the displays before reading the text.



Indicates that mishandling the product by disregarding this pictograph will cause severe injury or death.



Indicates that mishandling the product by disregarding this caution will cause a slight hazardous situation which can result in personal injury and/or material damage.



Indicates that mishandling the product by disregarding this warning will cause a potentially hazardous situation which can result in death or serious injury.

## For the safe usage of the product, the following pictographs are used:



Indicates "HANDLE WITH CARE." In order to protect the human body and equipment, this display is attached to places where the Owner's Manual, Serviceman Manual and/or Service Manual should be referred to.



Indicates a "Protective Earth Terminal." Before operating the equipment, be sure to connect it to the Ground.  
(The step may be omitted for products in which a power cord with earth is used.)

- **Perform work in accordance with the instructions herein stated.**  
Instructions for work are explained by paying attention to the aspect of accident prevention. Failing to perform work as per the instructions can cause accidents. In the case where only those who have technical expertise should perform the work to avoid hazardous situation, the instructions herein state that the site maintenance personnel should perform such work.
- **Be sure to turn off the power before working on the machine.**  
To prevent an electric shock, be sure to turn off the power before carrying out any work that requires direct contact with the interior of the product. If the work is to be performed in the power-on status, the Instruction Manual herein always states to that effect.
- **Be sure to ground the Earth Terminal.**  
**(This is not required in the case where a power cord with earth is used.)**  
This product is equipped with the Earth Terminal. When installing the product, connect the Earth Terminal to the "accurately grounded indoor earth terminal" by using an earth wire. Unless the product is grounded appropriately, the user can be subject to an electric shock. After performing repair, etc. for the control equipment, ensure that the Earth Wire is firmly connected to the control equipment.
- **Ensure that the Power Supply used is equipped with an Earth Leakage Breaker.**  
This product does not incorporate the Earth Leakage Breaker. Using a power supply which is not equipped with the Earth Leakage Breaker can cause a fire when earth leakage occurs.
- **Be sure to use fuses which meet the specified rating.**  
**(Only for the machines which use fuses.)**  
Using fuses exceeding the specified rating can cause a fire and an electric shock.

- **Specification changes (removal of equipment, conversion and addition) not designated by SEGA are not allowed.**

The parts of the product include warning labels for safety, covers for personal protection, etc. It is very hazardous to operate the product by removing parts and/or modifying the circuits. Should doors, lids and protective parts be damaged or lost, refrain from operating the product, and contact where the product was purchased from or the office herein stated.

SEGA shall not be held responsible for any accidents, compensation for damage to a third party, resulting from the specifications not designated by SEGA.

- **Ensure that the product meets the requirements of appropriate Electrical Specifications.**

Before installing the product, check for Electrical Specifications. SEGA products have a nameplate on which Electrical Specifications are described. Ensure that the product is compatible with the power supply voltage and frequency requirements of the location. Using any Electrical Specifications different from the designated Specifications can cause a fire and an electric shock.

- **Install and operate the product in places where appropriate lighting is available, allowing warning labels to be clearly read.**

To ensure safety for the customers, labels and printed instructions describing potentially hazardous situations are applied to places where accidents can be caused. Ensure that where the product is operated has sufficient lighting allowing the warnings to be read. If any label is peeled off, apply it again immediately. Please place an order with where the product was purchased from or the office herein stated.

- **When handling the monitor, be very careful. (Applies only to the product with a monitor.)**

Some of the monitor (TV) parts are subject to high tension voltage. Even after turning off the power, some portions are still subject to high tension voltage sometimes. Monitor repair and replacement should be performed only by those technical personnel who have knowledge of electricity and technical expertise.

- **Be sure to adjust the monitor/projector properly. (Applies only to the product with a monitor/projector.)**

Do not operate the product leaving on-screen flickering or blurring as it is. Using the product with the monitor/projector not properly adjusted may cause dizziness or a headache to an operator, a player, or the customers.

- **When transporting or reselling this product, be sure to attach this manual to the product.**

In the case where commercially available monitors and printers are used in this product, only the contents relating to this product are explained herein. Some commercially available equipment has functions and reactions not stated in this manual. Read this manual together with the specific Instruction Manual of such equipment.

*\*Descriptions herein contained may be subject to improvement changes without notice.*

*\*The contents described herein are fully prepared with due care. However, should any question arise or errors be found, please contact SEGA.*

## **INSPECTIONS IMMEDIATELY AFTER TRANSPORTING THE PRODUCT TO THE LOCATION**

Normally, at the time of shipment, SEGA products are in a status allowing for usage immediately after transporting to the location. Nevertheless, an irregular situation may occur during transportation. Before turning on the power, check the following points to ensure that the product has been transported in a satisfactory status.

- Are there any dented portions or defects (cuts, etc.) on the external surfaces of the cabinet?
- Are Casters and Adjusters damaged?
- Do the power supply voltage and frequency requirements meet with those of the location?
- Are all wiring connectors correctly and securely connected? Unless connected in the correct way, connector connections can not be made accurately. Do not insert connectors forcibly.
- Do power cords have cuts and dents?
- Do the fuses used meet specified ratings? Is the Circuit Protector in an energized status?
- Are all accessories available?
- Can all Doors and Lids be opened with the Accessory Keys? Can Doors and Lids be firmly closed?

# TABLE OF CONTENTS

BEFORE USING THE PRODUCT, BE SURE TO READ THE FOLLOWING:

TABLE OF CONTENTS

INTRODUCTION

<b>1</b>	<b>HANDLING PRECAUTIONS</b> .....	<b>1</b>
<b>2</b>	<b>SPECIFICATIONS</b> .....	<b>3</b>
<b>3</b>	<b>GAME DESCRIPTION</b> .....	<b>4</b>
	3-1 GAME OUTLINE .....	4
	3-2 GAME MODES .....	5
	3-3 THE GAME SCREEN (TOURNAMENT, VERSUS SINGLES) .....	6
	3-4 THE GAME SCREEN (DOUBLES TEAM) .....	7
	3-5 THE GAME SCREEN (CHALLENGE MODE) .....	8
	3-6 CONTROLS .....	9
	3-7 IC CARD (VIRTUA TENNIS 3 PLAYER'S CARD) OUTLINE .....	10
	3-8 USING AN IC CARD .....	10
<b>4</b>	<b>TEST MODE</b> .....	<b>14</b>
	4-1 SYSTEM TEST MODE .....	14
	4-2 GAME TEST MODE .....	15
	a. INPUT TEST .....	16
	b. OUTPUT TEST .....	17
	c. GAME ASSIGNMENT .....	18
	d. CARD TEST .....	20
	e. CLOSE SETTING .....	24
	f. BOOKKEEPING .....	26
	g. BACKUP DATA CLEAR .....	32
<b>5</b>	<b>GAME BOARD</b> .....	<b>33</b>
<b>6</b>	<b>SOFTWARE KIT</b> .....	<b>34</b>

Use of this product is unlikely to cause physical injuries or damage to property. However, points that require special attention are indicated by thick underlining, the word "IMPORTANT" and the symbol below.

**STOP** **IMPORTANT**

Indicates important information that, if ignored, may result in the mishandling of the product and cause faulty operation or damage to the product.

**STOP** **IMPORTANT**

- When using 1 player specific cabinets such as the NAOMI CABINET, the NET CITY series, or the BLAST CITY cabinet, set the **COIN CHUTE TYPE** under **COIN ASSIGNMENTS** to **COMMON**. When using a **VERSUS CITY** or other vs. play cabinets set the **COIN CHUTE TYPE** under **COIN ASSIGNMENTS** to **INDIVIDUAL**. Refer the DVD Soft Kit and separately attached manual for details on **COIN ASSIGNMENTS**.
- When the power is turned on for the first time, make sure to enter **TEST Mode** and check whether the input mechanisms are functioning correctly using the **INPUT TEST**.
- This game is available only with the **LINDBERGH** system. It is not available with other hardware.

# 1 HANDLING PRECAUTIONS

## WARNING

- Be sure to disconnect the cabinet power when assembling or removing the IC board as there is a risk of an electrical shock and of damaging the IC board.
- If any foreign matter gets onto the IC board or any dust builds up on the IC board, there is a risk that this will short the circuit causing the IC board to heat up and catch fire. Keep the top of the IC board clean at all times.
- You must use a cabinet which supports the LINDBERGH\*. Failure to do so may cause overheating and risk of fire.

\*: Cabinets that support the LINDBERGH are the LINDBERGH UNIVERSAL CABINET and any of the following cabinets if modified to support the LINDBERGH power supply – NAOMI CABINETS, NET CITY series cabinets and BLAST CITY cabinets.

## IMPORTANT

- Ensure that the connection between board and connectors is complete. The IC board may be damaged if it is not fully inserted.
- Use a logic tester to inspect the IC board circuit. Do not use a standard tester as there is a risk of damaging the IC board.
- When installing the IC board inside the cabinet or connecting the wire harness connector to board, take care not to shock the IC board with static electricity.
- When soldering buttons, etc. to the wire harness, remove the wire harness from the IC board to avoid heating the IC board.
- If the LINDBERGH is used without the shield case, electrical interference may be produced. Use the LINDBERGH with the shield case provided.
- The monitor for the LINDBERGH is compatible with the resolution of the video output; 640 x 480 (31kHz) and 1360 x 768. Cabinets using monitors not compatible with these resolutions cannot be used.
- The IC board's electronic components can be damaged by static charges transferred by human contact. Before performing operations involving the IC board, be sure to take adequate measures to discharge any static buildup in your body, such as touching a properly-grounded metal surface.

*Note: The contents herein described are subject to change without notice.*

## During Operation (Paying Attention To Customers)

“Virtua Tennis 3” can be played using the “VIRTUA TENNIS 3 PLAYER’S CARD” (hereafter called the Card). For this reason, bear in mind the following points when operating this game with Card use enabled.

### Card Use

To play using the Card, insert the Card as indicated below into the Card Reader/Writer insertion slot. Saving to the Card will not be possible and other problems may result if the procedure is incorrect. Make sure that individuals involved in operation are familiar with how to use the Card, so that they are able to guide players so as not to make mistakes, and are able to cope with any problems that may occur.

- Put in the coins and press the Start Button before inserting the Card into the Card insertion slot.
- The Card has “IN” and a triangular mark on one end. Insert the Card with that end forward into the insertion slot.
- Insert the Card firmly.
- Do not insert more than three Cards simultaneously.
- Do not use Cards with seals or other items affixed.
- Do not use Cards other than the “VIRTUA TENNIS 3 PLAYER’S CARD”.

### Cautions During Card Lock

During use, the Card is locked by the Card Reader/Writer.

Even while the Card is locked, it is possible to remove the Card by force. However, if it is removed during saving, the data may be damaged, and the Card may become unusable. For this reason, never remove the Card when it is locked. Instruct the players likewise.

## STOP IMPORTANT

### <Troubleshooting during Card updates>

- **There is a restore Card command in the CARD TEST in GAME TEST Mode. However, there is no guarantee that it will be possible to restore the Card. If the player wishes to restore the Card, make sure they understand that there is no guarantee before attempting to start a new game.**
- **The restore operation is based on update information recorded in the cabinet’s backup RAM. Restore will not work if information was not recorded in the backup RAM correctly during Card update, or if there are other problems.**

## 2 SPECIFICATIONS

### (1) ON-SCREEN DISPLAY

Monitor Position:

[HORIZONTAL]

Resolution of the video output:

- 640 x 480 (31kHz)
- 1360 x 768

*NOTE: The LINDBERGH DIP SW must be set correctly according to the monitor specifications in the cabinet that you are using. (Refer to the "LINDBERGH Service Manual")*

### (2) CONTROL PANEL

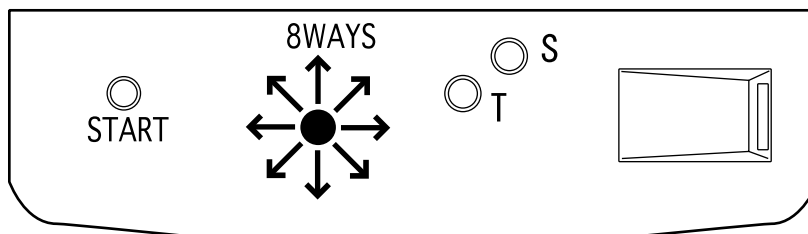

### (3) REQUIRED OPERATING ENVIRONMENT

It is recommended that this game be used with the Sega LINDBERGH support cabinet, the LINDBERGH UNIVERSAL CABINET, or any of the following cabinets if they have been modified to support the LINDBERGH power supply – NAOMI CABINETS, NET CITY series cabinets and BLAST CITY cabinets. The Card Reader/Writer Unit Kit (XKT-1538-01) is required for LINDBERGH UNIVERSAL CABINET. The Card Reader/Writer Attached Control Panel Kit (XKT-1526-01) is also required for NAOMI CABINETS, NET CITY series cabinets and BLAST CITY cabinets.

## 3 GAME DESCRIPTION

### 3-1 GAME OUTLINE

This is a tennis versus game featuring 12 real-life pro tennis players.

#### **The LINDBERGH board provides the highest quality graphics!**

The LINDBERGH board reproduces not only the appearance of the players but also faithfully recreates each of their individual mannerisms and movements making it almost like watching an actual live match on television, allowing you to feel like you are actually playing a real game.

#### **Famous Top Ranking Tennis Players!**

The greatest male players of the current tennis scene, are all here in “Virtua Tennis 3” including Roger Federer, Rafael Nadal, Andy Roddick and Lleyton Hewitt.

#### **Simple control using 1 joystick and 2 buttons!**

The simple one joystick and two buttons control system from “Virtua Tennis 2” remains. With simple game rules too, anyone can soon be enjoying an international level of play.

#### **Addition of the new “Challenge Mode”!**

Take on a series of challenges and aim for the million dollar prize! A series of challenges, ranging from the simple to the insanely difficult, have been prepared to really test a player’s skills.

#### **Customize your character using a game specific IC Card!**

As well as registering a name and keeping a record of results, outfit changes and alterations to playing style are also possible. Continuing play allows for the creation of a totally unique character.

There are numerous other features designed to increase the player’s desire to play more, including the SPT World Ranking, which players can climb by winning matches, and medals that can be earned by fulfilling certain criteria.



## 3-2 GAME MODES

### Single Player Games

Pressing the 1P or 2P START button when no one is playing the game will start a single player game. After selecting a character the following options appear on the Select Game Mode screen.

#### Tournament Mode

Stage clearing game type.

Enter tennis tournaments taking place across the world and aim to become the champion for that year.

The first to two games wins the match (initial settings).

Win a match to proceed to the next match. Losing a match results in game over.

#### Challenge Mode

Select and take on a challenge game type.

A player can take on 5 challenges in one game.

Success leads to harder challenges being offered, with more prize money.

When the fifth challenge ends, it is game over.

### Two Player Games

Pressing the START button on the unoccupied side when someone is already playing the game will start a two player game.

The Versus or Team Selection screen will then be displayed, and one of the following two player games can be selected. The player who joined the game can make the selection.

#### Versus Singles

The two players go head-to-head. The first to two games wins the match (initial settings).

The winner may then continue to play the game, but for the loser it is game over.

#### Doubles Team

The two players form a pair and play against a CPU doubles pair. Matches proceed as in Tournament Mode. The first to two games wins the match (initial settings).

Win a match to proceed to the next match. Losing a match results in game over.

### 3-3 THE GAME SCREEN (TOURNAMENT, VERSUS SINGLES)

<For "Vs Singles">

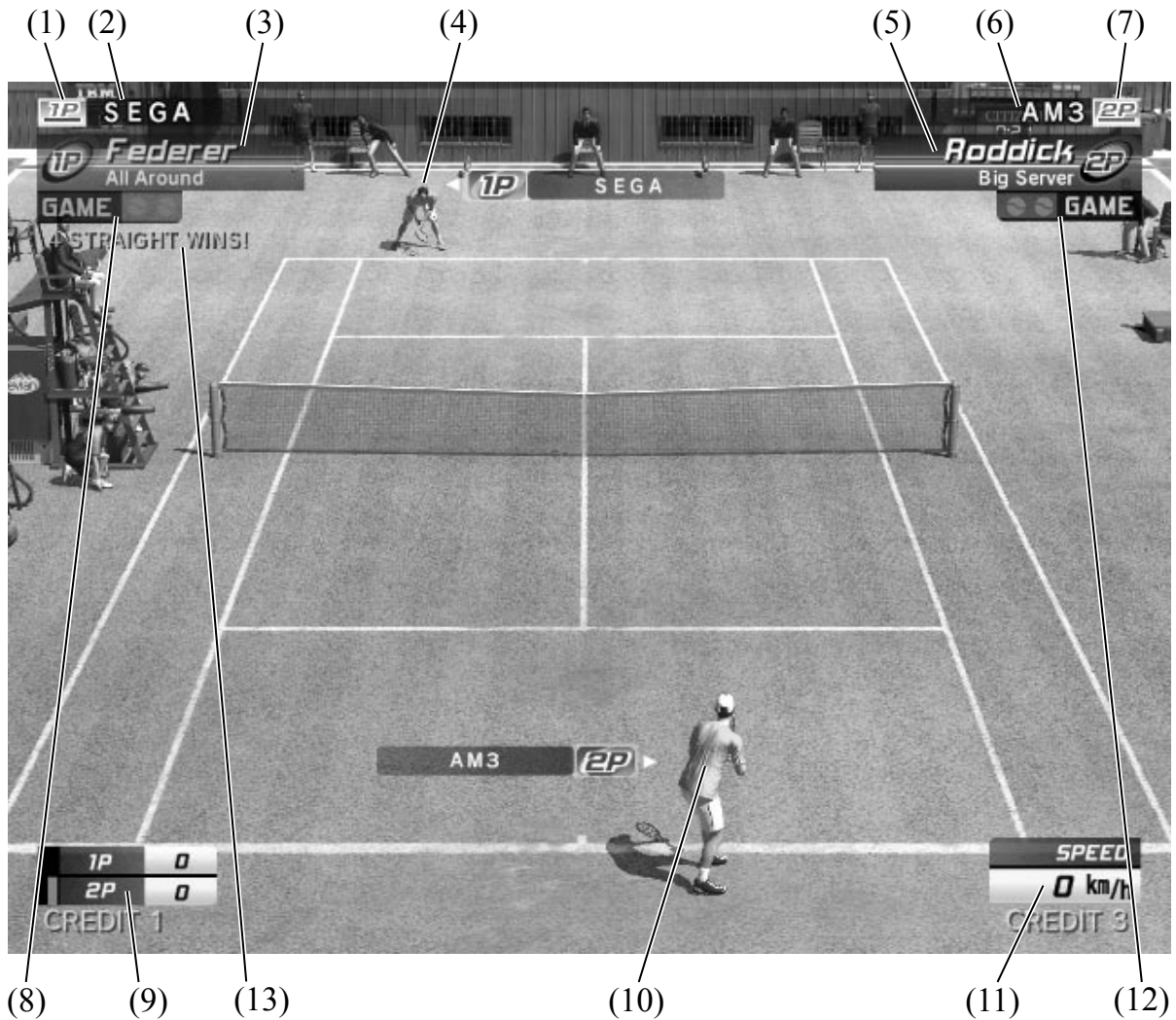

- (1) 1P IC Card Icon
- (2) 1P IC Card Registered Name
- (3) 1P Player Name and Play Style
- (4) 1P (Player)
- (5) 2P Player Name and Play Style
- (6) 2P IC Card Registered Name
- (7) 2P IC Card Icon
- (8) 1P Games Won
- (9) Points and Service
- (10) 2P (Player)
- (11) Serve Speed
- (12) 2P Games Won
- (13) Consecutive Wins

White display shows no. of consecutive wins on this play.

Yellow display shows no. of consecutive wins carried over by IC Card.

### 3-4 THE GAME SCREEN (DOUBLES TEAM)

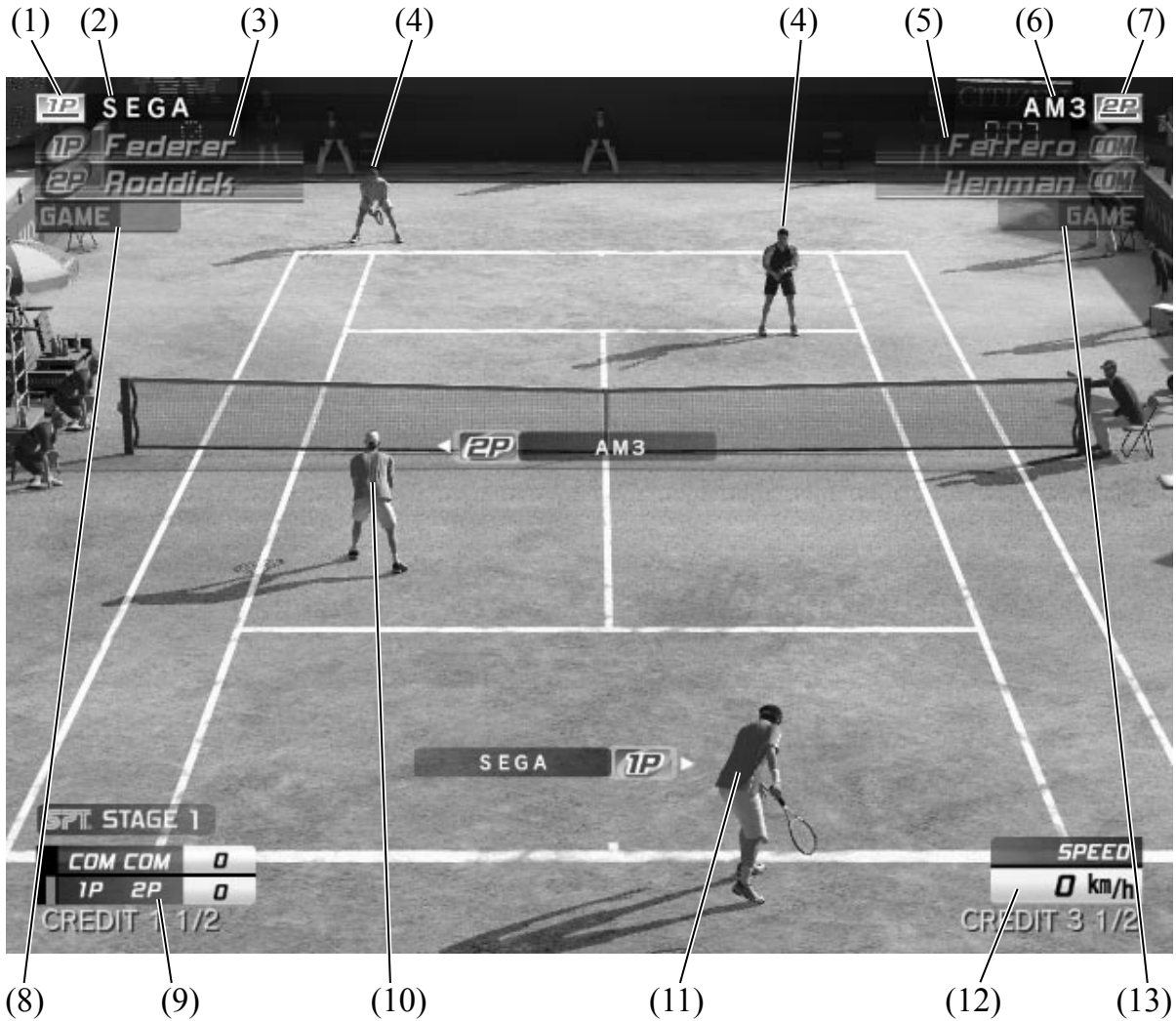

- (1) 1P IC Card Icon
- (2) 1P IC Card Registered Name
- (3) 1P / 2P Player Names
- (4) COM Pair
- (5) COM Pair Player Names
- (6) 2P IC Card Registered Name
- (7) 2P IC Card Icon
- (8) 1P / 2P Pair Games Won
- (9) Points and Service
- (10) 2P (Player)
- (11) 1P (Player)
- (12) Serve Speed
- (13) COM Pair Games Won

### 3-5 THE GAME SCREEN (CHALLENGE MODE)

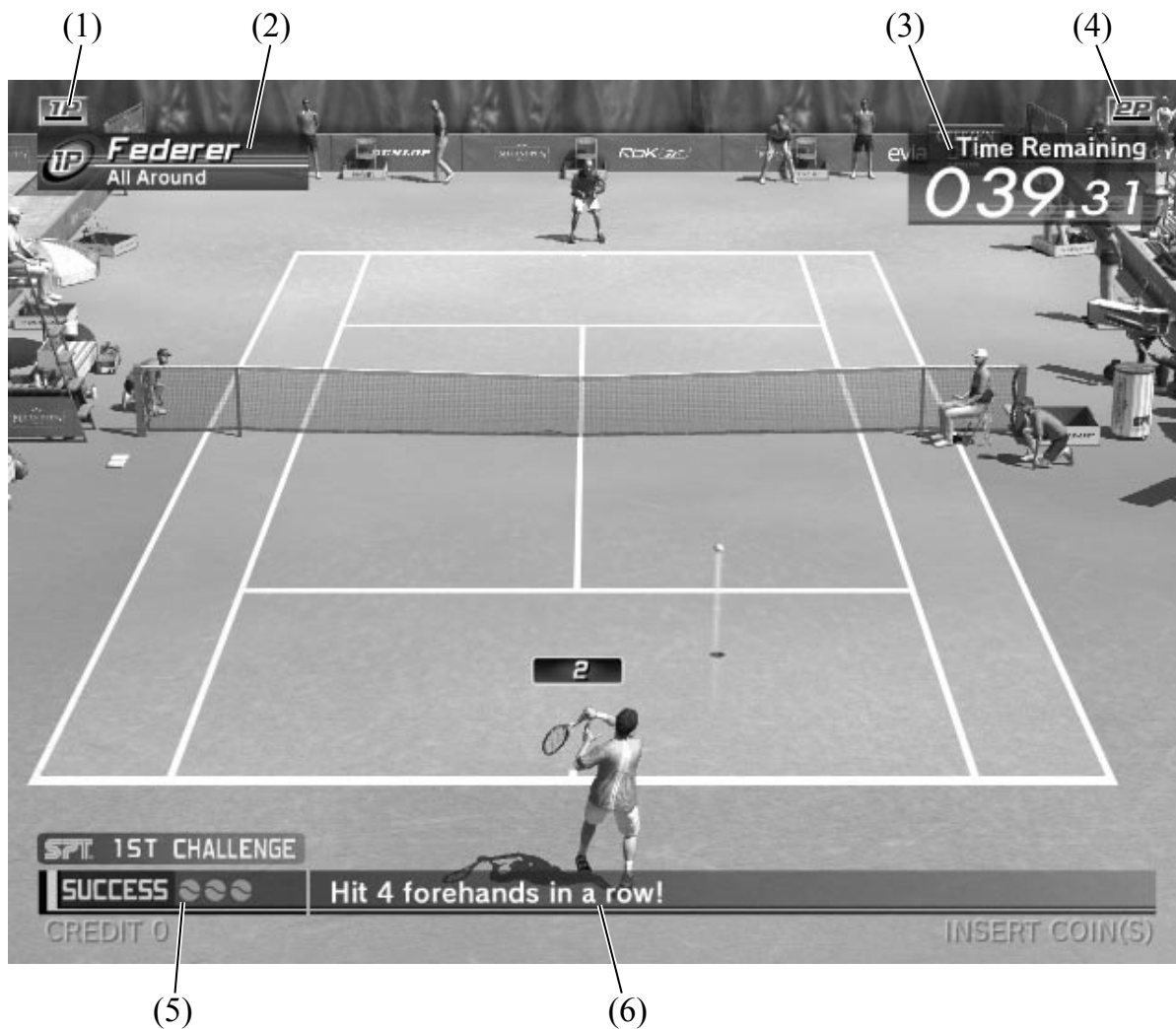

- (1) 1P IC Card Icon
- (2) Challenging Player Name and Play Style
- (3) Time Remaining
- (4) 2P IC Card Icon
- (5) Success
- (6) Challenge

## 3-6 CONTROLS

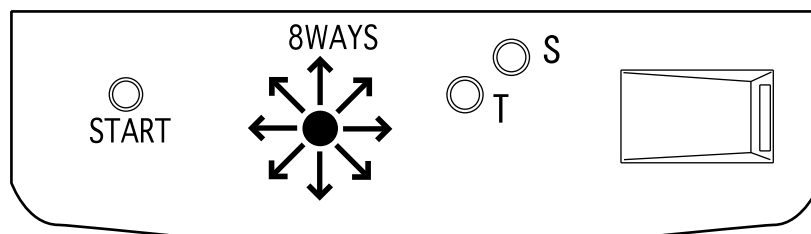

8-way joystick: Move the character and aim a shot

Top spin button: Hit the ball with top spin (groundstroke / volley etc. automatically selected.)

Slice button: Hit the ball with slice spin (groundstroke / volley etc. automatically selected.)

### Serve

Use left and right on the joystick to decide where to serve to, and then press the top spin or slice button. The player will then toss the ball up.

The serve gauge will now appear beside the character. Press the button again when the serve gauge is as close to MAX as possible.

The closer to MAX the gauge is, the harder the serve will be.

### Shots (Stroke/Volley/Smash)

When the opponent returns the ball, anticipate where it is traveling to and move there, then press the top spin or slice button to hit it back.

The direction of the shot can be changed by moving the joystick after pressing the button, but before the ball is hit.

The longer the time between pressing the button and actually hitting the ball, the more powerful the shot will be.

### Types of Shot

There are three types of shot available, depending on the button pressed.

Top Spin (T): Press the top spin button to hit a shot back with top spin.

The ball will fly fast, with a high arch and high bounce.

Slice (S): Press the slice button to hit a shot back with slice.

The ball will fly slowly with a low arch and low bounce.

Lob (T+S): Press both buttons together to hit a lob.

The ball will fly on a high arch over your opponent's head.

## 3-7 IC CARD (VIRTUA TENNIS 3 PLAYER'S CARD) OUTLINE

This game uses IC Cards.

Using a card allows a player to record their results, and take part in a World Ranking feature that they can climb by winning matches.

Players can also customize their character by changing play style, clothing and rackets.

## 3-8 USING AN IC CARD

### First Play Using an IC Card

#### 1. Character Select Screen

After buying a new card, insert it when the Character Select screen is displayed and select a player. The IC Card will then become a card for that player. It is not possible to change this selection again.

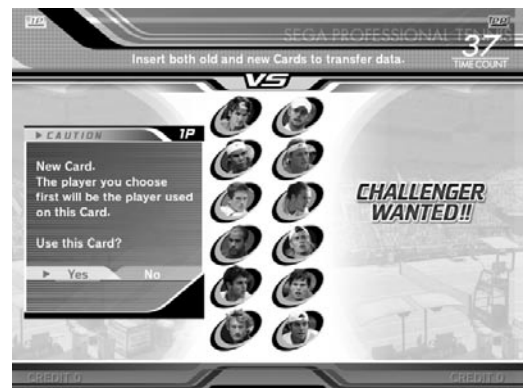

#### 2. Name Entry Screen

Register a name for the IC Card, up to a maximum of 10 letters.

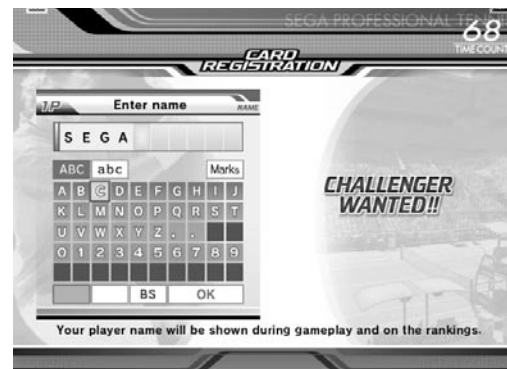

### 3. Outfit Select Screen

Select from one of four colors for your kit.

The initial registration is now complete.



### 4. Game Screen

Proceed to enjoy Tournament Mode, Challenge mode in either Versus or Team play.



### 5. Game Over Screen

If criteria have been fulfilled during the game, various messages may be displayed on the Game Over screen, such as “Moved up in rankings,” “Won medal” and “New play style available.”

By how much has my World Ranking gone up?  
 What medal did I win?  
 Which play style is now available?  
 This kind of thing can be checked at the start of the next game.



## Subsequent Plays Using an IC CARD

### 1. Character Select Screen

If you wish to use an IC Card, insert it when the Character Select screen is displayed.

The player information registered on the Card will be displayed. If it is correct, select “Yes.”



### 2. Medal Awards Screen

If medals or outfits were awarded during the previous game they will be displayed on this screen.



### 3. Outfit Awards Screen



### 4. Play Style Change Screen

Every now and then, it may also be proposed to change Play Style.



The game then proceeds as normal.



## IC Card Data Transfer

An IC Card can be used 200 times, each single player and versus game counting as one time. When the remaining uses reach 0 the Card can no longer be used and a new Card must be purchased. The following procedure is used to transfer the data from the old Card to the new one.

### 1. Character Select Screen

The data transfer process begins by inserting the old Card and new Card together when the Character Select screen is displayed.



### 2. During Data Transfer

Do not remove the Cards during the data transfer process.



### 3. Data Transfer Complete

This message indicates that the renewal process has been successfully completed.



The game then proceeds as normal.

## 4 TEST MODE

### 4-1 SYSTEM TEST MODE

#### STOP IMPORTANT

- The details of changes to Test Mode settings are saved when you exit from Test Mode by selecting EXIT from the SYSTEM MENU. Be careful because if the power is turned off before that point, changes to the settings will be lost.
- You may not enter Game Test Mode while the unit is reading from or checking the GD-ROM. If error messages are displayed when exiting Test Mode, you should power the unit off and on again.
- When you enter the Test Mode, fractional coin and bonus adder data is erased.

Change the following setting items as specified to use this product.

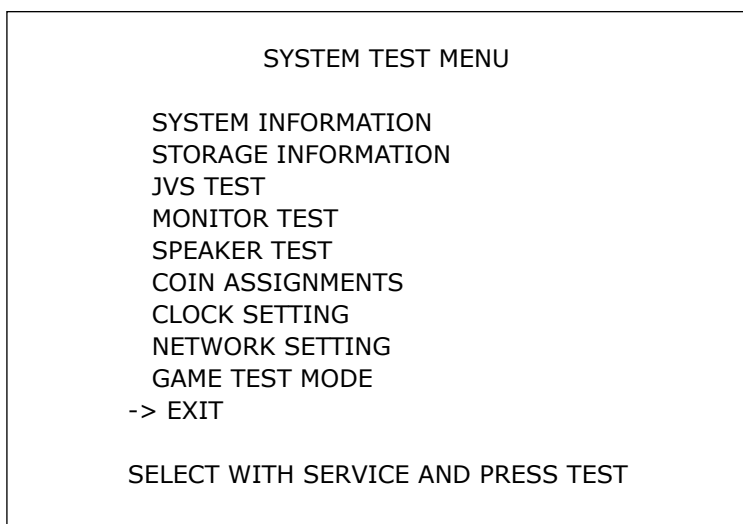

SYSTEM TEST MENU Screen

#### COIN ASSIGNMENTS

##### COIN CHUTE TYPE

Set this to match the cabinet as appropriate.

##### COIN TO CREDIT RATE

Set this as you see fit.

##### GAME COST SETTING

You can configure the number of credits needed to start/continue the game.

Set this as you see fit.

- 1 Use the SERVICE Button to move the cursor to the desired test item. Press the TEST Button to enter the selected item.
- 2 Press the TEST Button when GAME TEST MODE is selected to change to the Test Menu specific to this game. Refer to the next and subsequent pages.
- 3 After the test is complete, move the cursor to EXIT and press the TEST Button to return to the Game Advertisement Screen.

Refer to the Service Manual supplied with the LINDBERGH Kit for details on System Test Mode.

## 4-2 GAME TEST MODE

Select GAME TEST MODE from the System Test Menu screen to display the Game Test Menu screen as follows.

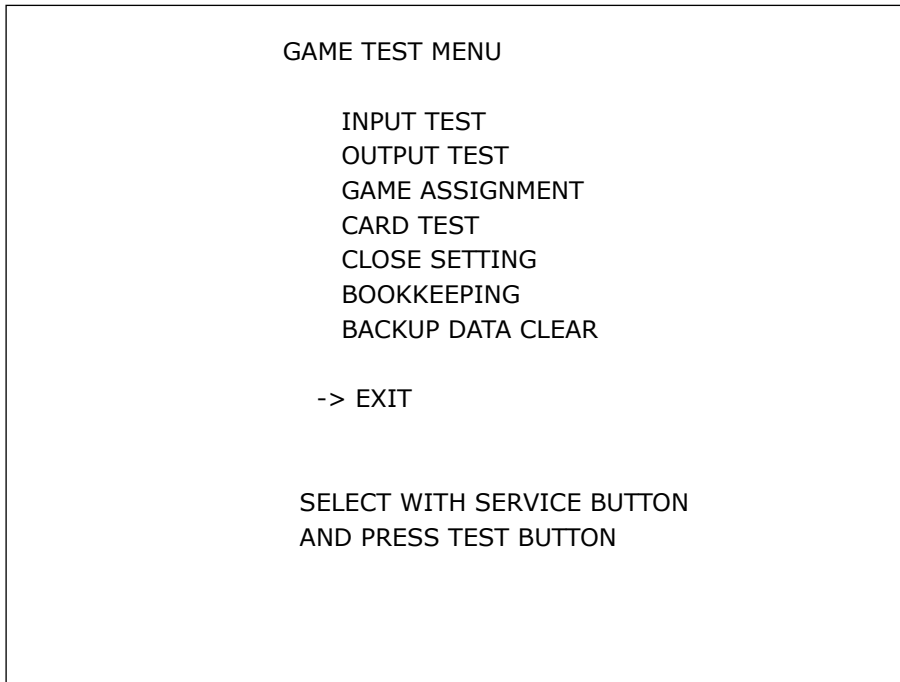

GAME TEST MENU Screen

- 1** Use the SERVICE Button to move the cursor to the desired test item. Press the TEST Button to enter the selected item.
- 2** After selecting an item, read the explanations below regarding operation.
- 3** After making changes, be sure to select EXIT and press the TEST Button in order to enable the new settings.
- 4** Select EXIT and press the TEST Button to end the Game Test Mode and return to the System Test Menu screen.

**a. INPUT TEST**

Select INPUT TEST to display the following screen and check the status of input devices. This test should be run periodically to ensure that each input device is functioning correctly.

INPUT TEST		
PLAYER	1P	2P
UP	OFF	OFF
DOWN	OFF	OFF
RIGHT	OFF	OFF
LEFT	OFF	OFF
SHOT1	OFF	OFF
SHOT2	OFF	OFF
START	OFF	OFF
CARD INSERTED SW	OFF	OFF
TEST	OFF	
SERVICE	OFF	

PRESS TEST AND SERVICE BUTTON  
TO EXIT

INPUT TEST Screen

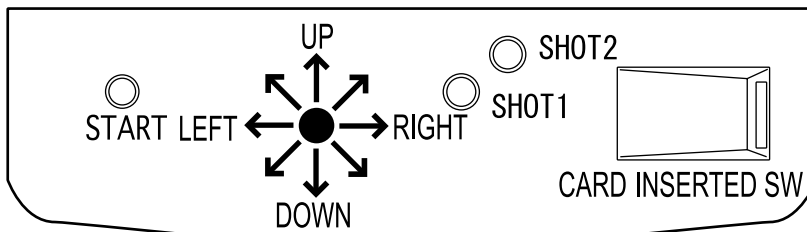

**1** The input buttons are functioning correctly if each respective display changes from “OFF” to “ON” when pressing the input buttons.

**2** Press the SERVICE and TEST Buttons simultaneously to return to the Game Test Mode screen.

**b. OUTPUT TEST**

Select OUTPUT TEST to display the following screen and perform a test of the Card Reader/Writer lock mechanism.

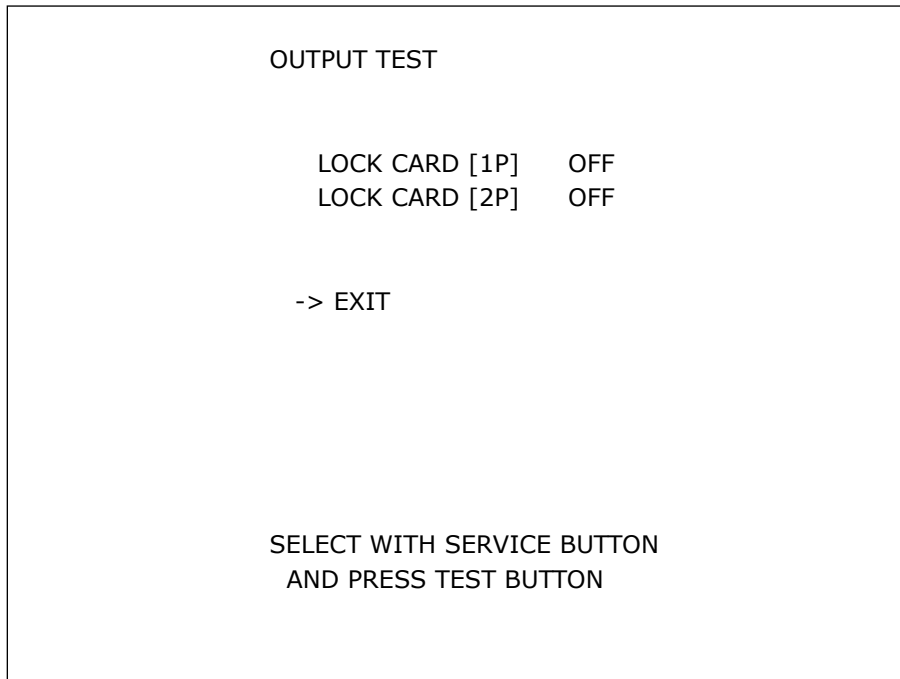

OUTPUT TEST Screen

- 
- 1** Press the SERVICE Button to move the cursor to the item to be checked.

---

  - 2** Move the cursor to LOCK CARD [1P] or [2P] and press the TEST Button. The selected Card Reader/Writer lock mechanism will turn ON, and press the TEST Button again to turn it OFF.

---

  - 3** Move the cursor to EXIT and press the TEST Button to return to the Game Test Menu screen.

## c. GAME ASSIGNMENT

Select GAME ASSIGNMENT to display the current game settings and make changes.

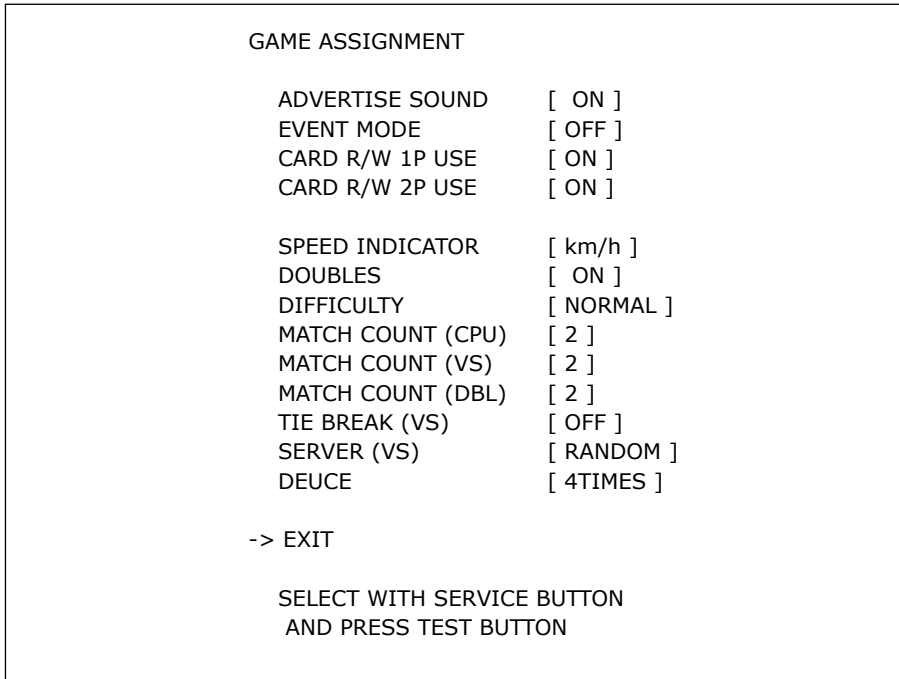

GAME ASSIGNMENT Screen

- 1 Press the SERVICE Button and move the cursor to the setting you wish to change.
- 2 Press the TEST Button to cycle the parameters on the left of the item through its various settings.
- 3 Changes to settings are not enabled until Test Mode is exited. After changing settings, be sure to exit Test Mode.
- 4 After changing the settings, select EXIT and press the TEST Button to return to the Game Test Menu screen.

### ADVERTISE SOUND

Turn sound during the Advertise (Attract) Mode ON or OFF. (The default setting is ON.)

### EVENT MODE

Turn ON when holding a tournament or other event. (The default setting is OFF.)

When set to ON the game will switch to "ONE MATCH MODE," and after each single match it will be GAME OVER.

During this Mode IC Cards will only be read, and never written to.

The number of remaining uses for IC Cards will also not decrease, so never use this Mode during regular running.

Also note that new Card Registration and Card Data Transfer operations also cannot be performed.

**CARD R/W 1P (2P) USE**

Set the operation Mode (allow use or not) of the 1P (2P) Card Reader/Writer. (The default setting is ON.)

ON: The Card Reader/Writer can be used.

OUT OF SERVICE: The Card Reader/Writer cannot be used. (Set for when broken etc.)  
A “/” mark where the Card icon should be at the top of the screen will inform users that Cards cannot be used.

OFF: The Card Reader/Writer will not be used at all.

The Card icon will totally disappear.

If both 1P and 2P are set to OFF then the Card explanation on the Attract Loop will also not be displayed.

**SPEED INDICATOR**

Select the units in which serve speed is displayed at the bottom right of the screen. (The default setting is km/h.)

km/h: Display in km/h.

Mph: Display in mph.

**DOUBLES**

Allow Doubles Team Mode to be played. When turned ON a player joining the game can choose from Versus Singles or Doubles Team. On Versus specific cabinets such as the NEW VERSUS CITY, it is recommended that this setting be turned OFF. (The default setting is ON.)

**DIFFICULTY**

Set the tournament Mode difficulty to one of four levels, EASY, NORMAL, HARD and VERY HARD.

(The default setting is NORMAL.)

**MATCH COUNT (CPU)**

Set the number of games needed to beat a CPU player from 1 ~ 6. (The default setting is 2.)

**MATCH COUNT (VS)**

Set the number of games needed to beat a human Versus player from 1 ~ 6. (The default setting is 2.)

(If TIE BREAK is set to ONLY, the number set here is not available.)

**MATCH COUNT (DBL)**

Set the number of games needed to win a doubles match from 1 ~ 6. (The default setting is 2.)

(If DOUBLES is set to OFF, the number set here is not available.)

**TIE BREAK (VS)**

If the number of games set under the Versus play setting are won, but a player isn't 2 or more games clear of their opponent, an additional game will be played. If scores are equal after this game, then a tie break will be played. In the tie break, points are counted (5, 6 etc.) and the first player to get to over 7 points, 2 or more points clear of their opponent is the winner. Each player has 2 serves before the serve is switched to the opponent. These rules are slightly different from those of actual tennis, but as fairer rules to decide the outcome of a game, they are recommended to be turned on for tournaments and other events. (The default setting is OFF.)

ON: The tie break system will be used.

OFF: The tie break system will not be used.

ONLY: Only the tie break system will be used.

The number of matches under MATCH COUNT (VS) will be ignored in this case.

**SERVER (VS)**

Set which player will serve first in Versus play. (The default setting is RANDOM.)

RANDOM: The first server will be decided randomly.

CHALLENGER: The challenging player will serve first.

**DEUCE**

If sets to ON, DEUCE will continue until the player gets 2 points continuously as like a normal game.

Set the number of times DEUCE may occur, from 4 TIMES, 9 TIMES, 14 TIMES, 19 TIMES, 24 TIMES and 29 TIMES.

Once that number is reached, “40-40” will be displayed and the player who wins the next point will win the game.

If turned OFF, then a score of “40-40” will not incur DEUCE and the player who wins the next point will win the game.

(The default setting is 4 TIMES.)

#### d. CARD TEST

Select CARD TEST to display the following screen and check the status of the Card Reader, and to restore data to Cards to which writing has failed.

This test should be run periodically to check the condition of the Card Reader.

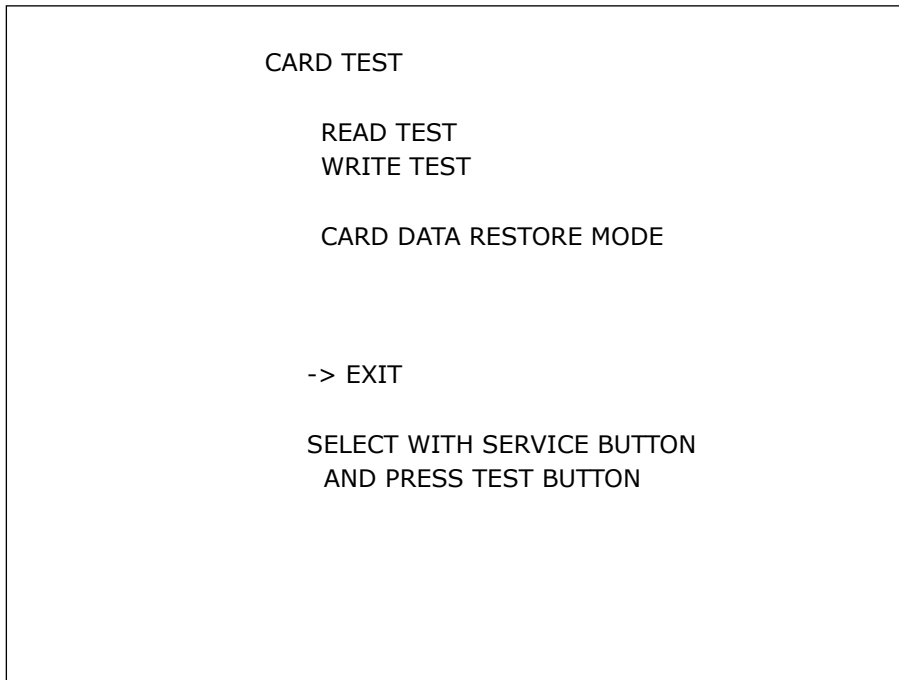

CARD TEST Screen

---

**1** Press the SERVICE Button to move the cursor to the item to be checked.

READ TEST:	Test Card reading.
WRITE TEST:	Test Card writing.
CARD DATA RESTORE MODE:	Attempt to restore Card data.

---

**2** Move the cursor to EXIT and press the TEST Button to return to the Game Test Menu screen.



**READ TEST**

```
READ TEST

[1P]
INSERT CARD SPECIFICALLY FOR THIS GAME.
DATA ON CARD MAY BE LOST.
DO NOT INSERT CARD CONTAINING IMPORTANT DATA.

CHECKING TIME :      2[SEC]
DETECTED CARD(S) : [1] DETECTED 1 CARD.
READ CARD(S) :      [1] READ DATA FROM 1 CARD.

[2P]
INSERT CARD SPECIFICALLY FOR THIS GAME.
DATA ON CARD MAY BE LOST.
DO NOT INSERT CARD CONTAINING IMPORTANT DATA.

-> EXIT

PRESS TEST TO EXIT
```

READ TEST Screen

- 
- 1** When the READ TEST screen is displayed, insert a Card into either the 1P or 2P Card slot and the Card Read Test will begin.

---

  - 2** Insert a Card and the Read Test will begin. The time it took to perform the check, the number of Cards detected and the number of Cards from which data was successfully read will be displayed.

---

  - 3** Press the TEST Button to return to the Card Test screen.

## WRITE TEST

WRITE TEST

[1P]  
INSERT CARD SPECIFICALLY FOR THIS GAME.  
DATA ON CARD MAY BE LOST.  
DO NOT INSERT CARD CONTAINING IMPORTANT DATA.

CHECKING TIME : 2[SEC]  
DETECTED CARD(S) : [1] DETECTED 1 CARD.  
WRITTEN CARD(S) : [1] WROTE DATA TO 1 CARD.

[2P]  
INSERT CARD SPECIFICALLY FOR THIS GAME.  
DATA ON CARD MAY BE LOST.  
DO NOT INSERT CARD CONTAINING IMPORTANT DATA.

-> EXIT

PRESS TEST TO EXIT

WRITE TEST Screen

- 
- 1** On the WRITE TEST screen insert a Card into either the 1P or 2P Card slot and the Card Write Test will begin.

---

  - 2** Insert a Card and the Write Test will begin. The time it took to perform the check, the number of Cards detected and the number of Cards from which data was successfully wrote will be displayed.

---

  - 3** Press the TEST Button to return to the Card Test screen.

## CARD DATA RESTORE MODE

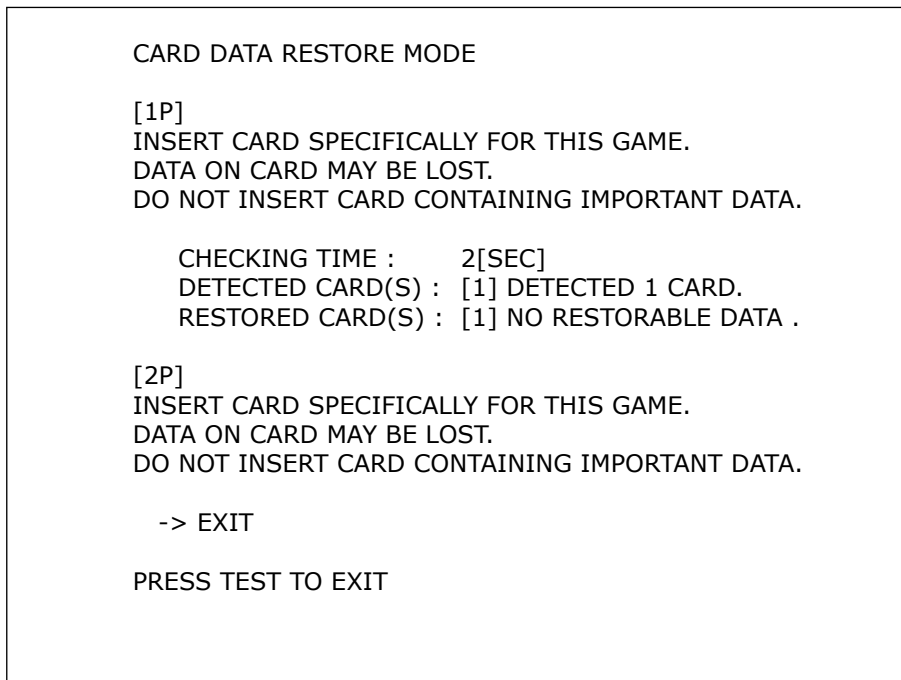

CARD DATA RESTORE MODE Screen

- 1 On the CARD DATA RESTORE screen, insert a Card into the 1P or 2P Card slot and an attempt to recover Card data will be made.

### Card Data Recovery...

- \*If a problem occurs during play and data is not written correctly to the Card the message “Unable to save game data to IC Card. Please notify staff upon finishing game play, as there is a possibility for unsaved data to be recovered” will be displayed on screen.
- \*If writing fails in this fashion, some of the data may still be stored in the main unit’s SRAM. Using the CARD DATA RESTORE MODE you may attempt to write again this data that has failed to be written.
- \*Data can only be written to the Card with the same serial number as the Card to which the data failed to write. You must therefore insert the Card to which the write originally failed.

- 2 After inserting the Card it will be checked, and if it contains data matching the serial number of the data saved in the SRAM, another attempt will be made to write to the Card. The time it took to perform the check, the number of Cards detected and the number of Cards to which data was successfully restored will be displayed.

- 3 Press the TEST Button to return to the Card Test screen.

**e. CLOSE SETTING****STOP IMPORTANT**

**15 minutes prior to the store's set closing time, even if during a winning streak, the Card will automatically be ejected after a match ends.**

Select CLOSE SETTING to display the following screen. Change the setting for the time when the store closes. If you set a closing time you can control the acceptance of Cards just before this time. Set a closing time and Cards will not be accepted from 15 minutes before the set time. It will then no longer be possible to insert Cards when the Character Select screen is displayed. 30 minutes before the set closing time the message "The center is closing. Card input will end soon" will be displayed on the Attract screen.

---

**1** Press the SERVICE Button to move the cursor.

---

**2** Move the cursor to SCHEDULE TYPE and press the TEST Button to select EVERY DAY, WEEK or OFF.

---

**3** Move the cursor to EXIT and press the TEST Button to return to the Game Test Menu screen.

**SCHEDULE TYPE ... EVERY DAY**

The closing time operation will be performed every day at the same time. Use the SERVICE Button to select a time, and press the TEST Button to change it. The time can be set in 15 minute units, between 19:00 and 29:00.

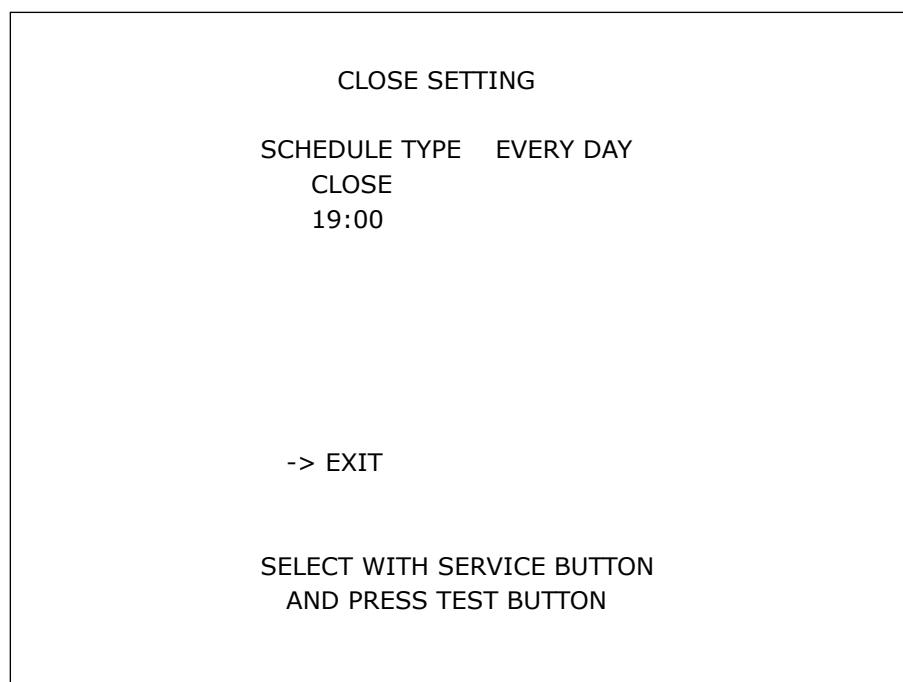

CLOSE SETTING Screen (EVERY DAY)

**SCHEDULE TYPE ... WEEK**

Set the closing time for each day of the week.

Use the SERVICE Button to select a day, and press the TEST Button to change the time.

The time can be set in 15 minute units, between 19:00 and 29:00.

CLOSE SETTING	
SCHEDULE TYPE WEEK	
CLOSE	
SUN	19:00
MON	19:00
TUE	19:00
WED	19:00
THU	19:00
FRI	19:00
SAT	19:00
-> EXIT	
SELECT WITH SERVICE BUTTON AND PRESS TEST BUTTON	

CLOSE SETTING Screen (WEEK)

**SCHEDULE TYPE ... OFF**

Do not use the closing time setting.

## f. BOOKKEEPING

Select BOOKKEEPING to display the following five operating data screens.

BOOKKEEPING (1/5)		
COIN 1		0
COIN 2		0
COIN 3		0
COIN 4		0
TOTAL COINS		0
COIN CREDIT		0
SERVICE CREDIT		0
TOTAL CREDIT		0

PRESS TEST BUTTON TO CONTINUE

BOOKKEEPING Screen (1/5)

### COIN 1/COIN 2/COIN 3/COIN 4

The number of coins counted through each coin slot.

### TOTAL COINS

The total number of coins inserted (COIN 1 ~ COIN 4).

### COIN CREDIT

The number of credits awarded by coins inserted.

### SERVICE CREDIT

The number of credits awarded by use of the SERVICE Button.

### TOTAL CREDIT

The total number of credits (COIN CREDIT + SERVICE CREDIT).

Pressing the TEST Button will bring up the following screen.

BOOKKEEPING (2/5)	
NUMBER OF GAMES	0
1P ALL CARD PLAY	0
2P ALL CARD PLAY	0
NEW CARD PLAY	0
PULLING CARD OUT	0
CARD PLAYER	0.0%
TOTAL TIME	0d 0h 0m 0s
TOTAL PLAY TIME	0d 0h 0m 0s
1P PLAY TIME	0d 0h 0m 0s
VS PLAY TIME	0d 0h 0m 0s
DBL PLAY TIME	0d 0h 0m 0s
PLAY TIME RATE	0.0%
1P TIME RATE	0.0%
VS TIME RATE	0.0%
DBL TIME RATE	0.0%
AVERAGE PLAY TIME	0d 0h 0m 0s
LONGEST PLAY TIME	0d 0h 0m 0s
SHORTEST PLAY TIME	0d 0h 0m 0s
PRESS TEST BUTTON TO CONTINUE	

BOOKKEEPING Screen (2/5)

**NUMBER OF GAMES**

The total number of games played.

**1P ALL CARD PLAY**

The total number of plays using a Card in the 1P side.

**2P ALL CARD PLAY**

The total number of plays using a Card in the 2P side.

**NEW CARD PLAY**

The number of new Cards created.

**PULLING CARD OUT**

The number of times a Card was pulled out during play and then not reinserted before GAME OVER.

**CARD PLAYER**

The proportion of the number of plays using Cards compared with the total number of plays (Card play ratio).

**TOTAL TIME**

The total time that the power supply has been ON.

**TOTAL PLAY TIME**

The total play time. (Not included in the Test Mode.)

**1P PLAY TIME**

The total Versus CPU play time for (single player).

**VS PLAY TIME**

The total Versus Singles play time (two players).

**DBL PLAY TIME**

The total Doubles Team play time (two players).

**PLAY TIME RATE**

The proportion of play time compared to the ON time.

**1P TIME RATE**

The proportion of Versus CPU play (single player).

**VS TIME RATE**

The proportion of Versus Singles play (two players).

**DBL TIME RATE**

The proportion of Doubles Team (two players) play.

**AVERAGE PLAY TIME**

The average play time.

**LONGEST PLAY TIME**

The longest play time.

**SHORTEST PLAY TIME**

The shortest play time.

Pressing the TEST Button will bring up the following screen.



BOOKKEEPING (3/5)		
[TIME HISTOGRAM]		
	- 3'59	0
4'00	- 4'59	0
5'00	- 5'59	0
6'00	- 6'59	0
7'00	- 7'59	0
8'00	- 8'59	0
9'00	- 9'59	0
10'00	- 10'59	0
11'00	- 11'59	0
12'00	- 12'59	0
13'00	- 13'59	0
14'00	- 14'59	0
15'00	- 15'59	0
16'00	- 16'59	0
17'00	- 17'59	0
18'00	- 18'59	0
19'00	- 19'59	0
20'00	-	0

PRESS TEST BUTTON TO CONTINUE

BOOKKEEPING Screen (3/5)

**TIME HISTOGRAM**

Displays play time for each hour of the day.

Pressing the TEST Button will bring up the following screen.

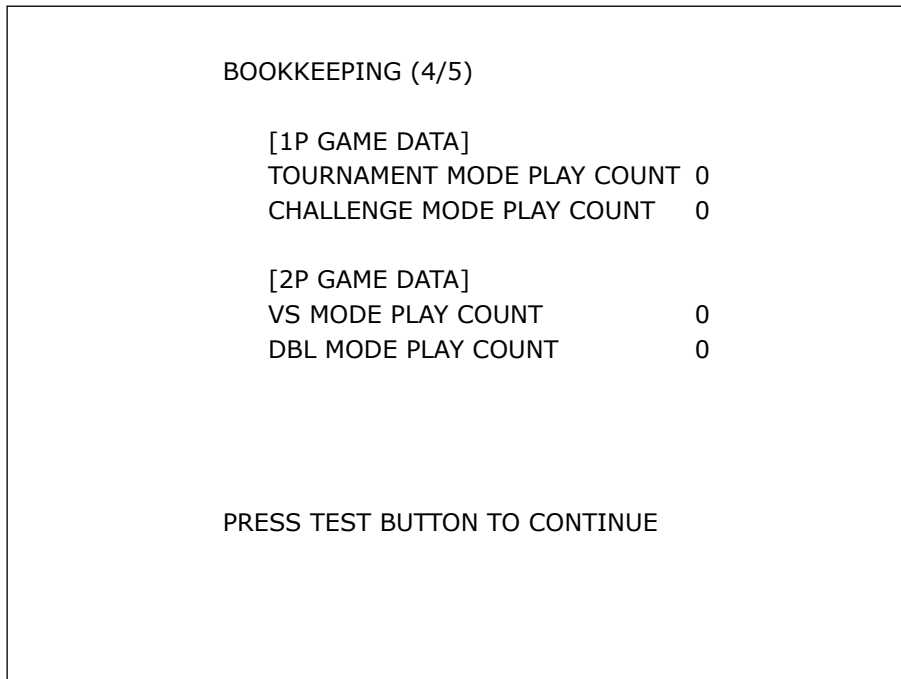

BOOKKEEPING Screen (4/5)

**TOURNAMENT MODE PLAY COUNT**

The number of Tournament Mode plays.

**CHALLENGE MODE PLAY COUNT**

The number of Challenge Mode plays.

**VS PLAY COUNT**

The number of Versus plays.

**DBL PLAY COUNT**

The number of Double Team plays.

Pressing the TEST Button will bring up the following screen.

BOOKKEEPING (5/5)				
[CHARACTER DATA]				
		SELECT	VS WIN	VS LOSE
FEDERER	(SUI)	0	0	0
RODDICK	(USA)	0	0	0
NADAL	(ESP)	0	0	0
NALBANDIAN	(ARG)	0	0	0
HENMAN	(GBR)	0	0	0
HAAS	(GER)	0	0	0
BLAKE	(USA)	0	0	0
HEWITT	(AUS)	0	0	0
ANCIC	(CRO)	0	0	0
DENT	(USA)	0	0	0
FERRERO	(ESP)	0	0	0
GROSJEAN	(FRA)	0	0	0

PRESS TEST BUTTON TO EXIT

BOOKKEEPING Screen (5/5)

The number of times each character has been selected, and their win and loss records in Versus games.

Press the TEST Button to return to the Game Test Menu screen.

## g. BACKUP DATA CLEAR

Select BACKUP DATA CLEAR to clear the contents of BOOKKEEPING and Ranking Data.

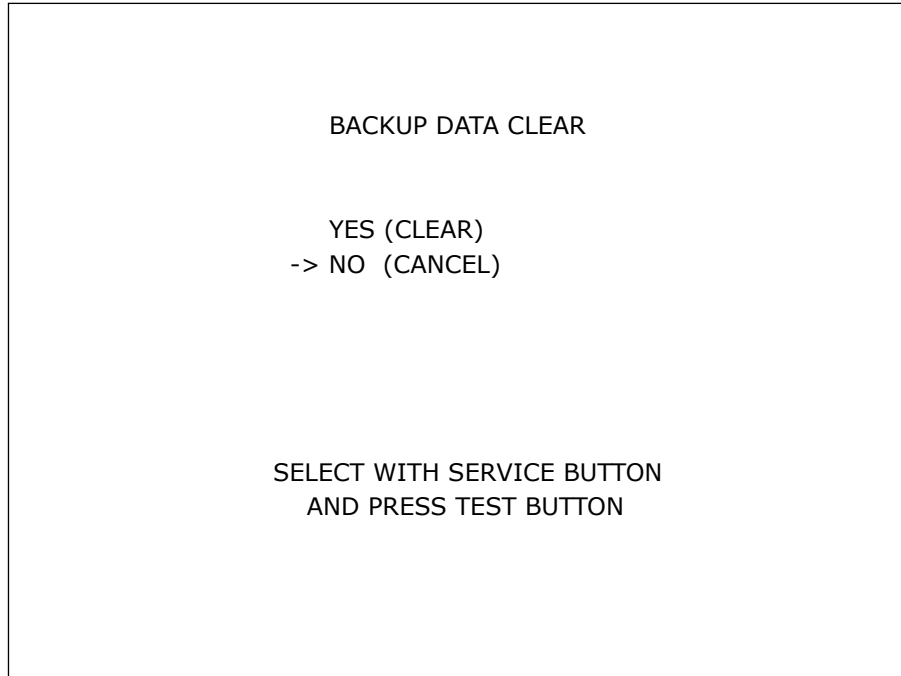

BACKUP DATA CLEAR Screen

- 1** To clear data, use the SERVICE Button to move the cursor to YES (CLEAR) and then press the TEST Button.
- 2** When the data has been cleared, the message “COMPLETED” will be displayed. Press the TEST Button again to return to the Game Test Menu screen.
- 3** Move the cursor to NO (CANCEL) and press the TEST Button to return to the Game Test Menu screen without clearing the data.

## 5 GAME BOARD

### CAUTION

- Avoid needless exposure of the game board as it can lead to accidents or malfunctions.
- Discharges of static electricity may damage the electric parts on the IC board. Prior to opening the shield case lid and beginning the operation always touch an earthed metal surface and discharge any static electricity you may have stored in your body.

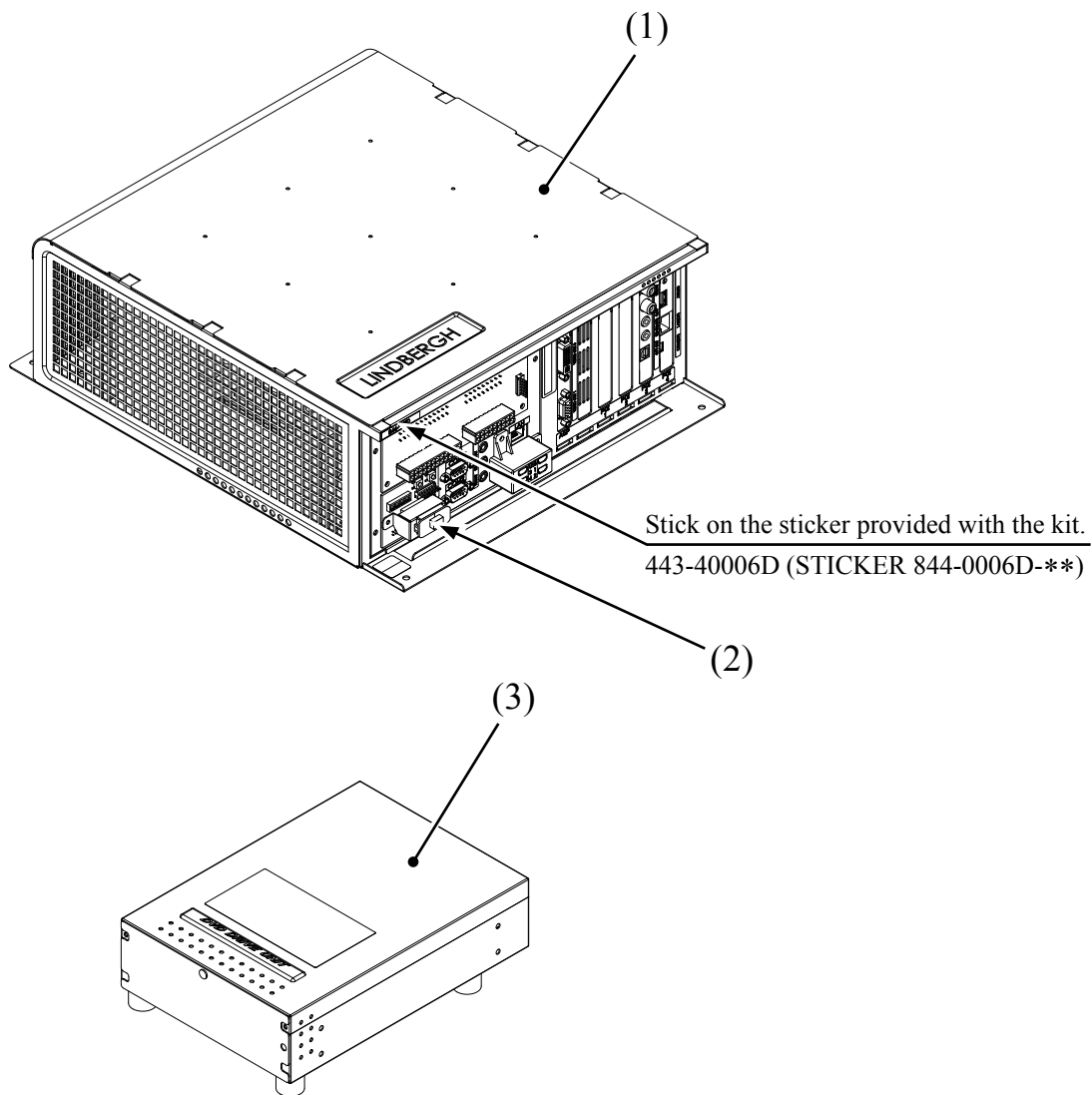

	PART NO.	DESCRIPTION
(1) + (2)	844 - 0006D - 01	ASSY CASE LBG L 1GB PS3 USA
	844 - 0006D - 02	ASSY CASE LBG L 1GB PS3 EXP
(1)	844 - 0001D - 01	ASSY CASE LBG L 1GB USA
	844 - 0001D - 11	ASSY CASE LBG L 1GB 7800 USA
(2)	844 - 0001D - 02	ASSY CASE LBG L 1GB EXP
	844 - 0001D - 12	ASSY CASE LBG L 1GB 7800 EXP
(2)	—	KEY CHIP
(3)	610 - 0719 - 01	DVD-DRIVE UNIT USB

## 6 SOFTWARE KIT

### STOP IMPORTANT

#### Handling the DVD-ROM Disc

- Do not use a DVD-ROM with a damaged front. This may cause a malfunction.
- Insert the DVD-ROM into the DVD drive with the label facing upwards.
- Do not get fingerprints or dust particles on the disc. Contaminated discs may lower audio and video quality, and may result in read malfunctions.
- When cleaning the disc, do not use volatile chemicals (benzene, thinner, etc.), cleaning sprays, or antistatic agents.
- Do not use a cracked, warped, or damaged disc. Do not attach papers or seals onto the disc to avoid scratching it. Do not use a disc with signs of peeled seals, tape, etc. If such a disc is placed in the DVD-ROM drive, malfunctions, such as the inability to remove the disc from the drive, may result.
- When cleaning a heavily contaminated disc, use a clean cloth that has been soaked in water and squeezed. After wiping, remove any remaining moisture with a clean, dry cloth.

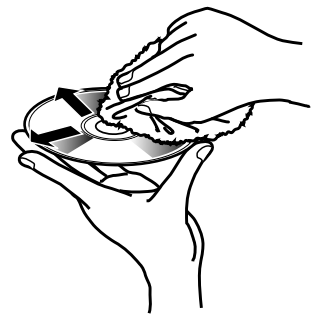

Use a clean cloth to wipe the disc gently with strokes away from the center.

#### How to Hold a Disc

When handling a disc, be careful not to contaminate it with your fingerprints.

##### With both hands:

Put your thumbs and forefingers on 4 opposite sides of the disc.

##### With one hand:

Insert your forefinger into the center hole, while placing your thumb and middle finger on opposite sides of the disc.

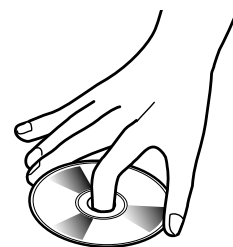

#### Handling the Key Chip

- The key chip is a precision device. Handle it carefully and avoid exposure to heat, shock and static electricity, as these may cause damage to the device.
- The key chip is contained in the DVD-ROM disc case. Always use them as a set.

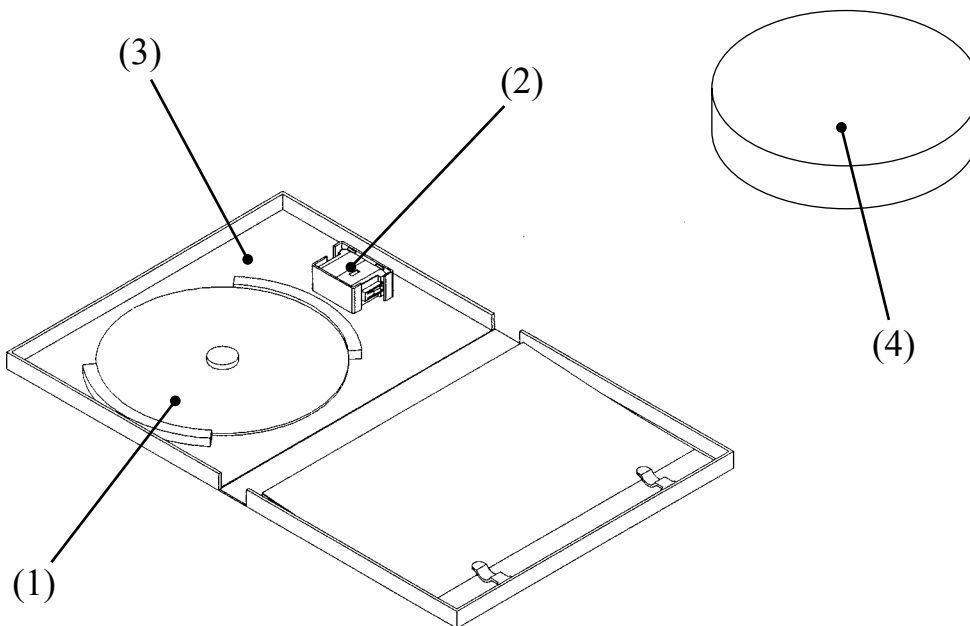

When you order the DVD-ROM disc only, specify the part number “610-0726-0005” (DVD SOFT PS3).

	PART NO.	DESCRIPTION
(1) + (2) + (3) + (4)	610-0727-0005	DVD SOFT KIT PS3
(1)	—	LBG DVDROM PS3
(2)	—	KEY CHIP
(3)	253-5507-01	DISK CASE WITH IC HOLDER LBG
(1) + (3) + (4)	610-0726-0005	DVD SOFT PS3
(4)	601-11137	CUSHION SPONGE D 120 x T13.5