

Safety Precautions

- Do not subject the device to severe impact or drop it from heights.
- Do not use the device in extreme hot or cold, dusty or damp conditions. Do not expose it to direct sunlight.
- Avoid using the device near strong magnetic fields.
- Normal functioning of the product may be disturbed by ESD. If so, simply reset and restart the device following the instruction manual. During file transmission, please handle with care and operate in a static-free environment.
- Keep the device away from water and other liquids. In the event that water or other liquids enter the device, power off the product immediately and clean the device.
- Do not use chemicals to clean the device in order to avoid corrosion. Clean it with a dry cloth.
- Do not install this equipment in a confined space such as a book case or similar unit. The ventilation should not be impeded by covering the ventilation openings with items such as newspaper, table-cloths, curtains etc.
- No naked flame sources, such as lighted candles, should be placed on the apparatus.
- Attention should be drawn to environmental aspects of battery disposal.
- Use the apparatus in moderate climates.
- We are not responsible for damage or lost data caused by malfunction, misuse, modification of the device or battery replacement.
- Do not attempt to disassemble, repair or modify the product. This will invalidate the warranty.
- If the device will not be used for an extended period of time, please charge the battery at least once per month to maintain battery life.
- Charge the battery if:
 - a) The battery level icon displays (An empty battery)
 - b) The device powers off automatically when restarted.
 - c) There is no response when pressing keys with keys unlocked and battery full.
- Do not interrupt the connection when the device is being formatted or transferring files. Otherwise, data may be corrupted or lost.
- When the device is used as a portable HD, please use only per the instructions. Otherwise, permanent data loss could occur.
- Please use and install data using the attachments/accessories provided and only according to the manufacturer's instruction.
- Please refer to the information on the bottom of the device for electrical and safety information before installing data or operating the device.
- To reduce the risk of fire or electric shock, do not expose this device to rain or moisture. The device should not be exposed to dripping or splashing. Never place objects filled with liquids, such as vases, on the device.
- There is danger of explosion if the battery is replaced incorrectly. Replace only

with the same or equivalent type.

- The battery (battery or batteries or battery pack) should not be exposed to excessive heat such as sunlight, fire or the like.
- Please follow responsible procedures for battery disposal.
- If the power adaptor disconnected from the device, the device will remain operable as long as the battery has sufficient charge.
- The power adaptor is a CLASS II apparatus with double insulation, and no external ground is provided.
- Safety symbol explanation:



- The lightning flash with arrowhead symbol within an equilateral triangle is intended to alert the user to the presence of non-insulated “dangerous voltage” within the product’s enclosure that may be of sufficient magnitude to constitute a risk of electric shock.
- To reduce the risk of electric shock, do not remove the cover (or back) as there are no user-serviceable parts inside. Refer servicing to qualified personnel.
- The exclamation point within an equilateral triangle is intended to alert the user to the presence of important operating and maintenance instructions in the literature accompanying the device.
- Correct Disposal of this product. This marking indicates that this product should not be disposed of with other household waste in the EU. To prevent possible harm to the environment or human health from uncontrolled waste disposal, recycle it responsibly to promote the sustainable reuse of material resources. To dispose of your used device, please use the return and collection systems available in your area or contact the retailer where the product was purchased. They can take this product for safe environmental recycling.
- This equipment should be installed and operated with minimum distance 20cm between the radiator & your body.
- CE in which countries where the product may be used freely: Germany, UK, Italy , Spain, Belgium, Netherlands, Portugal, Greece, Ireland, Denmark, Luxembourg g, Austria, Finland, Sweden, Norway and Iceland. In France, except the channel 10 through 13, law prohibits the use of other channels.

Listening Cautions

- This product respects the current regulations for limiting the output volume of consumer audio devices to a safe level. By listening to your device with headphones or earbuds at high volumes, you run the risk of permanent damage to your ears. Even if you get used to listening at high volumes and it seems normal to you, you still risk the possibility of damaging your hearing. Reduce the volume of your device to a reasonable level to avoid permanent hearing damage. If you hear ringing in your ears, reduce the volume or shut off your device. This device has been tested with the supplied earphones. In order to preserve your hearing, it is advised that you use only the following headphone models: the earphones supplied with your device, or any other headphones that respect the current regulations. Other types of headphones may produce higher volume levels. (At full power ,the prolonged listening of the walkman can damage the ear of the use)
- Maximum output voltage \leq 150mv
- Do not use while operating a motorized vehicle. It may create a traffic hazard and is illegal in many areas.
- You should use extreme caution or temporarily discontinue use in potentially hazardous situations created by obstructed hearing.
- Even if your headphones or earphones are the open-air type designed to let you hear outside sounds, don't turn up the volume so high that you can't hear what's around you.
- Sound can be deceiving. Over time your hearing "comfort level" adapts to higher volumes of sound. What sounds "normal" can actually be loud and harmful to your hearing. Guard against this by setting the volume of your device at a safe level BEFORE your hearing adapts.
To establish a safe volume level:
 - a. Start your volume control at a low setting.
 - b. Slowly increase the sound until you can hear it comfortably and clearly, and without distortion. Once you have established a comfortable sound level, leave it there.

This manual may not reflect your actual device's operation. All information is subject to change without prior notification. Please follow your actual device's operational procedures.

Table of Content

Safety Precautions	1
Listening Cautions	3
Feature Summary	5
Accessories	5
Buttons & Ports	5
Charging Battery	6
Installing Memory Card	6
Transferring Files	7
Turning On/Off	7
Home Screen	8
Unlocking the Screen	10
Touch Screen & Buttons Usage	10
Accessing Internet	10
Reading E-Books	13
Playing Music	14
Playing Video	16
Viewing Photos	18
Exploring Files	20
Sending/Receiving E-mails	23
Managing 3 rd Party Applications	26
Managing Tasks	26
System Settings	27
Troubleshooting	27
Specifications	27
FCC Statement	29

Feature Summary

Wi-Fi and 3G network

With the built-in Wi-Fi technology and external 3G dongle (optional), this device may provide you easy access to internet.

8.0 " Touch Screen

Touch or slide your finger on the screen, the screen responds instantly.

Third-party Application Support

With the built-in Android™ OS, you can install a large number of third-party .apk applications in this device.

Built-in Camera Lens

Equipped with the built-in camera lens, this unit can function as a webcam or video recorder.

Built-in G-sensor

The screen changes to landscape or portrait automatically when the device rotates.

Entertainment

You can enjoy music, movies, pictures and e-books with the device.

Accessories

- Main Unit
- USB Cable
- USB Host Cable
- AC Adaptor
- User Manual
- Warranty Card

Buttons & Ports

Top View

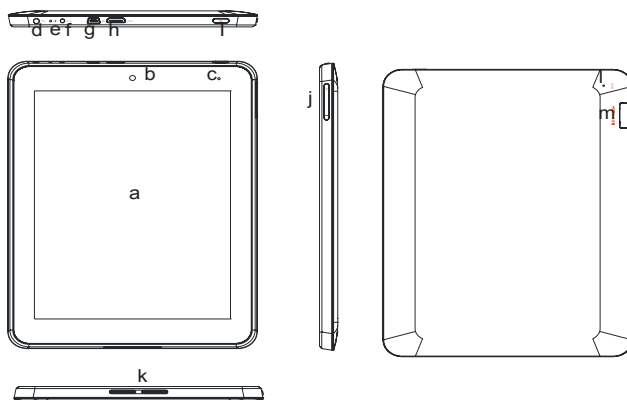

- a. **Touch Screen**
- b. **Built-in Camera Lens**
- c. **Charging indicator**– Lights red during charging, and lights green as charging completes.
- d. **Earphone socket** – connects to stereo earphones.
- e. **Microphone**
- f. **DC-IN port** – connects to any standard electric source through the provided AC adaptor.
- g. **USB Port** – Connects to PC via USB cable; connects to USB memory device, keyboard, or mouse; connects to 3G dongle via USB host cable.
- h. **HDMI jack** – Connects to HD TV that supports HDMI connection.
- i. **Power** –Press and hold to turn on or off the unit; briefly press to lock or unlock the screen.
- j. **VOL+/-** – Increase/ decrease the volume.
- k. **Built-in Speakers**
- l. **Reset pin hole** – reset your device if the device freezes.
- m. **MicroSD card Slot**

Note: DO NOT insert or remove the memory card when the device is working with it. That may cause errors or other failures.

Charging Battery

The device has a built-in rechargeable battery. No extra battery installation is required. Just charge the device when it indicates low battery.

To charge the battery, connect the device to any standard wall outlet via the DC-IN port using the power adaptor. It takes about 5 hours to fully charge the battery. When the battery is fully charged, the charge indicator at the left bottom should light up in green. During charging, the indicator lights up in red.

Note:

- a. **You are strongly recommended to charge the battery immediately when the device indicates the battery is lower than 15%!**
- b. *You can operate the device even when it is being charged. But for extended battery life, it is suggested NOT to use the device when it is charging.*
- c. *It is recommended to charge the battery before you use the device for the first time.*
- d. *For maximum performance, lithium-ion batteries need to be used often. If you don't use the device often, be sure to recharge the battery at least once per month.*
- e. **Be sure to use only the dedicated power adaptor provided with the unit for charging.**

Installing Memory Card

This device can read files directly from memory card.

To use a memory card, find the card slot at the bottom of the device and then insert the memory card into the slot in the correct orientation.

To access the files stored in the memory card, enter the **Explorer** mode by tapping the Explorer icon and select the “SD Card” directory.

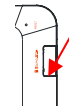

Transferring Files

Before reading or playing files, you may need to transfer media files from a computer to the device.

- (1) Connect the device to a computer with the supplied USB cable.
- (2) Once the connection is done, the device will notify "USB connected" and tell you to tap to turn on the USB storage.
- (3) When the USB storage is turned on, the device then notifies "USB storage in use". Instantly, two more removable disk drives will show on your computer standing for the internal memory of the device, and the memory card inside it. Now you can copy files from or to the memory card just as you do on your hard drive.
- (4) When the device is connected to computer, you can drag from the top bar downwards any time to display the USB notification message as shown.



Drag downwards

- (5) To disconnect the device to computer, select and tap on the button "Turn off USB storage".
- (6) Disconnect the device from the PC safely.

Note: The pre-installed applications and Android OS occupy a considerable part of capacity – nearly 1.2 GB, that is why you see the total space is about that much less than the nominated value in the Spec.

Turning On/Off

To turn on the device, press and hold the **Power** button on the unit until you see the boot-up screen. It may take a short while to start up the system, please wait before you proceed.

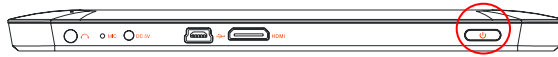

To turn off the device, press and hold the **Power** button until you see the option "Power Off", tap on "Power Off" and then tap on "OK".

Tip: For the sake of power saving, this device may sleep with the screen display locked when there is no touch actions for a while (depending on the actual setting of Screen Timeout). You can briefly press the **Power** button to wake it up.

Home Screen



- a. Search bar
- b. Current Time and world-wide city weather forecast
- c. Icons of main applications
- d. Ebook Reader / Applications /Setting shortcuts

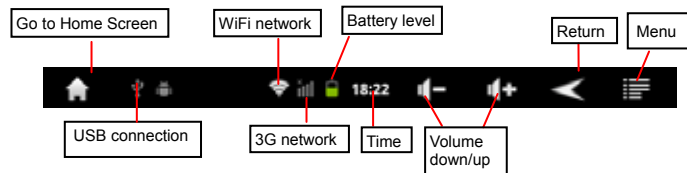

The extended Home Screen



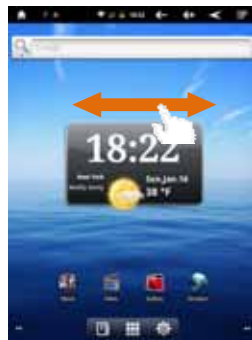

Slide your finger horizontally on the screen to go to the left or right panel of the extended Home Screen.



Customize the Home Screen

You can customize the Home Screen by adding/removing shortcuts and widgets.

changing the wallpaper.

- To add a Home Screen item (shortcuts, widgets, folders etc.), tap on the Menu icon  and then select "Add" . You can also hold your finger on the screen and then choose an item from the list.
- You can add a folder onto the Home Screen by holding your finger on the screen and then choose Folders → New Folder. You can drag shortcuts or widgets to the folder.
To rename the folder, a) tap to open the folder, b) hold your finger on the title bar of the opened folder until the Rename window pops up, c) input folder name.
- To move a Home Screen item, hold your finger onto it until it is highlighted, then drag it to the desired location, and release it.
- To remove a Home Screen item, hold your finger onto it until it is highlighted, drag it to the recycle bin which turns from the **Application Tab**, and then release your finger.
- To change the wallpaper, from the Home Screen, tap on the Menu icon , a list of options appears. Tap on "Wallpaper" and then choose a picture as the desktop wallpaper.
- To change the System Settings, from the Home Screen, tap on the Menu icon , and then tap on "Settings" . Choose a category: "Wireless & Networks", "Sound & Display", "Date & Time", etc. For more information on the different settings, see the System Settings section.

Weather Forecast Setting

- You can choose a worldwide city you are interested in by tapping the weather forecast indicator. Locate the city by selecting the state where the city is and then selecting the city, or inputting the city name directly in the "Search City" field.
- You can change the default temperature unit by checking or unchecking the "Use Celsius" option.



Display all Applications

The device has many useful applications pre-installed. You can tap the Application Tab  to display them.



Unlocking the Screen

The screen will lock itself when no action performed on it for short while. You will have to unlock the screen by pressing POWER button once and dragging the lock icon







to the arrow direction before you continue to use the device.

Note: Dragging the icon to the arrow direction will mute the sound.

Touch Screen & Buttons Usage

Main Touch Screen Actions

- **ESC** : You can always return to upper level menus interface by tapping this icon once or repeatedly. (on the top right of the screen)
- **HOME** : You can always return directly to the Home screen by tapping on this icon (on the top left of the screen).
- **MENU** : In different application interface, tap this icon to display the context menu options.
- While playing a video or song, you can pause/resume it by tapping on the Pause  / Play  icon.

Other Touch Screen Actions

- When watching a video or listening to music, you can tap on the progress bar to playback any designated section of the file. You can drag the cursor of the progress bar to any other elapsed time point of the file.
- In different browsers (File, Music, Video, Photo, etc.), you can hold your finger on the screen and then drag up and down to scroll the file list up and down.
- In some browsers (File, Music, Video, Photo, Web etc.), you may hold your finger on an item to display options.



Accessing Internet

This device features built-in WiFi (Wireless network) and external 3G Dongle(3G network) connection which enable you to access internet very easily.

If you want to use WiFi network to access internet, you need to configure a Wi-Fi network first, and you shall have to stay in a service zone of WiFi too. Once a WiFi network has been successfully configured, the device will attempt to connect to it automatically each time.

Make WI-FI Connection

Before launching an Internet application such as the web browser, you first need to activate the Wi-Fi and configure a Wi-Fi network.

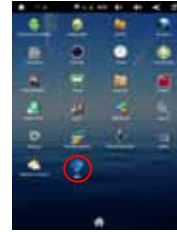

- (1) In apps screen, tap the WiFi icon  to open the WiFi network configuration menu;
- (2) Tap the “**Wi-Fi**” setting to turn on Wi-Fi connection if it is off.
- (3) Select “**Wi-Fi settings**”, this device will scan automatically for available Wi-Fi networks and display the result. The list of available networks shows all the wireless networks of which your device is within the service range.

Note:

- a) *The available network list is constantly refreshed automatically.*
- b) *When the Wi-Fi is enabled, the device will connect automatically to your configured networks when they are in range.*
- c) *If the device detects a network that has never been configured, it will display a notification icon.*

- (4) Tap the network you want to connect to, enter the network information (password) if required and then tap “Connect”. This device will now attempt to establish a connection to that Wi-Fi hot spot with the network parameters you entered. If the connection is successful, the message Connected to XXX will appear under the WI-FI setting.



Advanced Connection

To manually scan for available Wi-Fi networks,

- (1) In the “Wi-Fi settings” screen, tap the **Menu** icon , and then tap “Scan.”
- (2) If the Wi-Fi network you want to connect to does not appear in the list, scroll down the screen, then tap “Add a Wi-Fi network.” Enter the required information, and then tap “Save.”

To set up IP address manually, tap the Menu icon , tap “Advanced” and then input all required network parameters (“Regulatory domain,” “IP address,” etc). You can obtain these parameters from the network administrator.

Launching the Web browser

To launch the Web browser, you tap the Browser icon  in the Applications screen. If you are already connected to a network, the Web browser will simply open and you can start browsing the Web. To access a new website, tap the Menu icon  to display the menu, and then select “Go” to input the new website address.

Note: *Not all wireless networks offer access to the Internet. Some Wi-Fi networks only link several computers together, without any Internet connection.*

Using the Virtual Keyboard

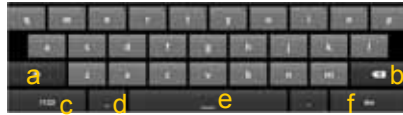

Tapping on any text input field can open the virtual board. With the virtual keyboard, you can enter a website address or any text required.

Indications



- a. Caps Lock
- b. Backspace.
- c. Number and Characters /Letter Keyboard Switch.
- d. Input method setting
- e. Space
- f. Enter

Using the Web Browser

- You can scroll the screen up and down by tapping on the page and dragging it up or down (be careful not to tap a link until you are ready!).
- To open a link, simply tap it.
- You can open several web pages at a time, view them all at once on the screen, and then tap one of them to view it in full screen.
- To go back to the previous page that you browsed, tap the Back icon .
- To display the available menu items, tap the Menu icon .
- To go back directly to the Home screen, tap the Home icon .
- Depending on where you are in the web browser, holding down on an item will give you access to more options.
- To fill in a text field, tap in the field, then use the virtual keyboard to type in the required text.

Using 3G Dongle

Besides Wi-Fi connection, you can access internet by 3G dongle. Connect a 3G dongle (not provided with the product) with the device through the USB host cable(also not provided with the product), and then the 3G network is enabled with 3G icon appearing at the bottom right of the screen. You can surf on the Internet freely now. Please make sure the setting "Data enabled" under "Wireless & network settings" → "Mobile networks" is checked before surfing.



Note :

1. The 3G Dongle device and the USB Host cable needed for this function are not included in the accessories of the product, thus user have to purchase them from the market.
 2. The USB host cable can be used to connect the 3G Dongle or a U disk. When using 3G Dongle, you need to disconnect WiFi network.
 3. This product support a 3G Dongle of most brands or types on the market , but considering the compatibility of different types, you are still suggested to buy one only when you have tested it OK.
-

Reading E-Books

Transfer E-books from Computer

Before reading, you need to transfer or download e-books to the device. You can copy e-books from your computer's local drive to the device by USB connection (see the "Transferring files" section mentioned before).

Note: Make sure your e-books are in format of PDF, EPUB, TXT, FB2, RTF or PDB supported by the device.

Start Reading

- (1) In the Home Screen, tap the E-book Reader shortcut to enter the e-book reader mode.
- (2) Tap an e-book to start reading immediately.



History and My Library

You can tap "History" to view your reading history or tap "My Library" to enter the e-book library. "History" shows all of the e-books that you have read by date. "My Library" shows all of e-books stored in the device.

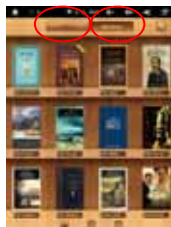

Note: E-book cover will show as defaulted cover by the device if the e-book has no cover data. That's why you see some e-book covers are the same.

Page Up/Down

When you are reading the e-book, you can slide your finger on the screen left and right to page up or down.

You can turn the Ebook page up and down automatically by: a) tapping the **Menu** icon

☰ to display e-book settings; b) Tap “Auto Flip”; c) Selecting a flip interval time.

Increase Font Size

- (1) When you are reading, tap the **Menu** icon ☰ to display e-book settings.
- (2) Tap “Font Size” to adjust the font size.
- (3) Tap a size that you want, and then tap “OK” to confirm.

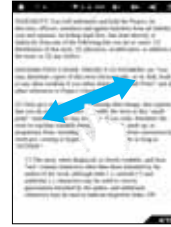

Jump to a Page

You can directly go to a page that you have specified.

- (1) When you are reading, tap the **Menu** icon ☰ to display e-book settings.
- (2) Tap “Go to”.
- (3) Tap the page number input field to display the virtual keyboard.
- (4) Tap the numbers to input the page number.
- (5) Once you finish inputting the page number, tap “OK” to jump to the specified page.



Use Bookmarks

You can add, delete or load bookmarks on the page.

- (1) When you are reading, tap the **Menu** icon ☰ to display e-book settings.
- (2) Tap “Bookmarks” to display a bookmark menu. Use the menu to add, delete or display bookmarks.

Show Outline of the e-book

You can view the outline of the e-book and then choose your desired chapter or section to read.

- (1) When you are reading, tap on the Menu icon ☰ to display e-book settings.
- (2) Tap on “TOC” to display the outline of the e-book, and then tap the chapter that you want to read.

View Book Information



During reading Ebook, you can view the book information anytime by tapping on the Menu icon ☰ and selecting **BookInfo** item in sequence.





Playing Music

In the **Home Screen**, tap the Music icon to enter the music player mode.

In music menu, all the music files can be sorted in different ways (Songs, Artist, Album, Playlist etc.)

- You can drag your finger up and down on the file list to scroll through it.
- Tap a song to play.

- To return to the Home Screen, tap  / .







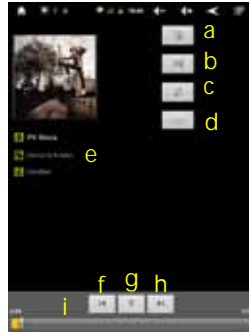

 Songs	List all music files.
 Artist	List music files by artist.
 Album	List music files by album.
 Playlist	List your favorite songs.
 Now Playing	Go to the Now Playing screen.



Playback Screen

f d i h



- Now Playing List
- Shuffle songs /Not shuffle
- Repeat /Not repeat
- Display lyrics/ not display
- ID 3 information (Artist Name/Album Name /Song Name)
- Previous song/Rewind
- Play/Pause
- Next song/Fast Forward
- Progress bar

- To pause or resume the playback, tap on the Pause  / Play  icon.
- To play the previous/next song, tap on  / .
- You can tap on the progression bar to go directly to a different location in the song. You can also drag the cursor of the progress bar to another location in the song.
- Tap  to adjust the volume.
- To preview songs on the list, tap , and then tap a song for preview.
- To change the repeat mode, tap .
- To display menu options, tap .
- Tapping continuously on the track title can search for the information about the track from the Internet.

To go back directly to the Home screen, tap on the Home icon  or Return icon .

Playlist

The playlist is a list of songs that you have added manually.

To play the playlist,



- (1) In the Music menu, tap the Playlist icon  to display all the playlist. All songs that you have added are listed.
- (2) Tap a song to start playing.

Playing Video

In the **Home Screen**, tap the Video Player icon to enter the video player mode. Optionally, you can tap the Applications shortcut to display all applications and then tap the Video Player icon to enter the video mode.

Navigate through Video Files









You should see the video list when you enter the video player.



- You can drag your finger up and down on the video list to scroll the video list up and down.
- Tap a video to start playing.
- You can go back directly to the **Home Screen** by tapping on the Return icon  or Home icon .

Playback Screen



- a. VOL-
- b. Progress bar
- c. VOL+
- d. Bookmark
- e. Brightness
- f. Previous video/Fast Rewind
- g. Play/Pause
- h. Next video/Fast forward
- i. View Mode
- j. Exit
- k. Video settings

- Tap on the  icon to pause/resume the video playback.
- Tap on  to display the menu items.
- Tap on the progress bar to go directly to a different location in the video. You can also use your finger to drag the cursor in the progress bar to another location in the video.
- Tap on  /  to adjust the volume.
- Tap on  to set a bookmark at the current spot in the video. Please note only one bookmark can be set for one video, and the new bookmark should cover the old one. To resume playing a video from the bookmark, go to the Home Screen, enter the Video Player, and tap on the bookmarked video. You should be prompted to "Play from beginning" and "Play from bookmark". Select "Play from bookmark". In default, the video plays from beginning. To remove the bookmark, tap on  to display the menu, and then choose "Delete Bookmark".
- Tap on  to adjust the brightness of screen.
- Tap on  /  to play the previous or next video.

- Tap on  to change the aspect ratio of screen.
- Tap on  to stop playing and return the video list.

Note: Some video files may not be played correctly with the device. Refer to the Technical Specifications at the end of the manual, and make sure the video resolution, encoding format or file type is supported.

Video Playback Settings

Tap on the  icon to display the video settings.

Delete BookMark and Play from beginning	Delete bookmark and play from beginning.
Delete Bookmark	Delete the video bookmark.
Play Mode	Single – plays the current video and then stops after playing. Repeat One – Repeat the current video. Repeat All – Repeat all videos.
Help	Get instructions on playing video.
Return	Exit from the menu.

Output video image to TV screen

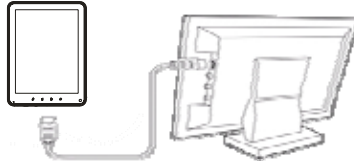

The device features a HDMI interface with which you can connect it to digital audio devices, computer monitors or digital televisions. HDMI connection can deliver high-definition videos.



To use the HDMI function on digital televisions,

- (1) Make sure that the digital television to be connected with has a corresponding HDMI interface.
- (2) Connect this device to the digital television with proper HDMI cable.
- (3) Turn on the television, and set it to HDMI mode.
- (4) Turn on the device and play a video. The video will be output to digital television automatically, and the display screen of the device will turn black completely as HDMI connection is working.
- (5) Enjoy the sharpest image quality on the wide screen of television.
- (6) To enable the image display on the screen of the device, disconnect the HDMI cable between the device and the television.

Viewing Photos

In the **Home Screen**, tap the **Gallery** icon to enter the photo viewer mode. Optionally, you can tap the Applications shortcut to display all applications and then tap the **Gallery** icon to enter the photo Gallery.

Viewing Photos

- (1) Folders containing photos should be listed once you enter the Gallery. Tap a folder to open it.
- (2) Photos in the opened folder are listed in thumbnail. You can slide your finger on the screen or tap   to browse photo thumbnails.



- (3) You can tap the Thumbnail/Group toggle button  to display photo thumbnails or group photos by date.

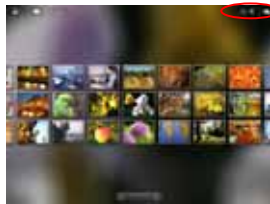

- (4) Tap a photo thumbnail to view the photo in full screen.



- (5) To display the previous/next picture, slide your finger on the screen horizontally.



(6) To zoom in or out the picture, pinch your finger on the picture.

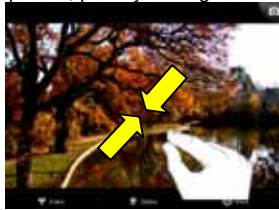

Display Toolbar

When you are viewing the picture, you can tap on the screen or the Menu icon  to show a floating menu.



Start slideshow Display menu options

Zoom in/Out

Tapping "Menu" can display other menu options.

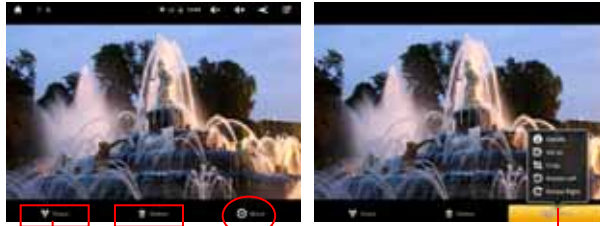

Send picture to friend by e-mail (email account login required)
Delete picture

Information about the picture
Set the picture as desktop background
Crop a part from the picture
Rotate the picture left
Rotate the picture right

Using the Camera

The device features built-in VCR which allows you make video clips or take photos. Tap on the **Application Tab** to display applications, and then select **“Camera”** to enter the VCR/Photography mode.

- To start making video clips, tap on the Start/Stop button  to start video recording.

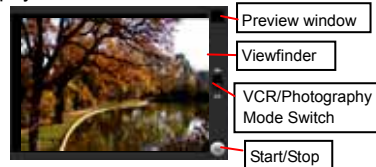

- Tap on the Start/Stop button  again to stop video recording or photographing.
- The video clip / photo can be previewed in the Preview Window.
- To play the video clip that you have made, enter the Video Player, and then tap the video.
- To view the photo that you have taken, enter the Photo Viewer mode, and then tap the photo.



Exploring Files

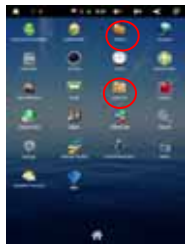



You can explore files and folders with either the Explorer or ASTRO application. In the Home Screen, tap the Applications shortcut to display all applications and then tap the Explorer or ASTRO icon to enter the file explorer mode.



Using the Explorer

Navigate through Files and Folders

- You can drag your finger up and down to scroll the file list up and down.
- To open a file or folder, tap the file/folder.
- Tap the menu icon , you can manage the applications (see details in the “Managing 3rd party Applications” section).
- You can go back or forward one level in the interface by tapping on the **Back** icon  or **Next** icon .

- You can go back one level in the directory by tapping on the LevelUp button 
- Wherever you are in the interface, you can go back directly to the Home screen by tapping on the Return icon  or Home icon .
- Tap the Home icon  to go to the root directory.

Using the Toolbar

You can use the toolbar to navigate through your device's internal memory/ memory card and delete or copy files.

Tapping on the grey area can hide/display the toolbar.



Sliding your finger on the toolbar can scroll through all tools.

Home	Go to the Home Screen.
LevelUp	Go back one level in the directory.
Multi	Select more than one file.
Editor	Copy, delete, move, paste or rename the file or folder.
Back	Go back one level in the interface.
Next	Go forward one level in the interface.

Copy/Move Files and Folders

- (1) In the file list, scroll up and down by sliding your finger to select the file/folder that you want to copy or move.
- (2) Hold the selected file/folder until a pop-up menu appears.
- (3) Select "Copy" or "Move" from the pop-up menu.
- (4) Navigate to the location where you wish to copy or move the file/folder to.
- (5) Select the Editor icon  from the toolbar and then choose "Paste."



Delete Files and Folders

- (1) In the file list, scroll up and down the list by sliding finger to select the file/folder that you want to delete.
- (2) Hold the selected file/folder until a pop-up menu appears.
- (3) Select "Delete" from the pop-up menu, then select "Delete" to confirm or "Cancel" to quit.

Rename Files and Folders

- (1) In the file list, scroll up and down the list by sliding finger to select the file/folder that you want to rename.
- (2) Hold the selected file/folder until a pop-up menu appears.
- (3) Select "Rename" from the pop-up menu.

- (4) Tap the input field to display the virtual keyboard, and then choose letters from the virtual keyboard to rename the file/folders.
- (5) Tap "OK" to confirm the new name.

Select Multiple Items

You can select more than one file or folder together.

- (1) In the top toolbar, tap the Multi icon "☰".
- (2) Tap the files/folders you want to choose. The file/folder name turns red when selected. (To deselect the file/folder, tap it again.)
- (3) Once you finished selection, you can delete, copy or move the selected files by tapping on the Editor icon "✂".

Using the ASTRO

Navigate through Files and Folders

- You can drag your finger up and down to scroll the file list up and down.
- To open a file or folder, tap the file/folder.
- Tap the menu icon "☰", you can manage the applications (see details in the "Managing 3rd party Applications" section).
- You can go back or forward one level in the interface by tapping on the **Back** icon "◀" or **Next** icon "▶".
- You can go back one level in the directory by tapping on the LevelUp button "⬆".
- Wherever you are in the interface, you can go back directly to the Home screen by tapping on the Return icon "⏪" or Home icon "🏠".
- Tap the Home icon "🏠" to go to the root directory.

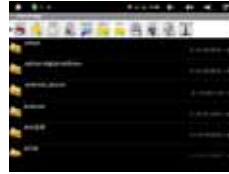

Using the Toolbar

You can use the toolbar to navigate through your device's internal memory/ memory card and delete or copy files.

Tapping on the grey area can hide/display the toolbar.





Sliding your finger on the toolbar can scroll through all tools.



Home	Go to the Home Screen.
Up	Go back one level in the directory.
Multi	Select more than one file.
Edit	Copy, delete, move, paste or rename the file or folder.
Search	Search for a specific file or folder

Back	Go back one level in the interface.
Next	Go forward one level in the interface.
View	Display files and folders in list or icons.
Sort	Sort files and folders by name, date, size or file type.
Prefs	Preferences for the ASTRO
Network	Enable the Wi-Fi network or Bluetooth.



Copy/Move Files and Folders

- (1) Navigate through the file/folder and locate the file/folder you want.
- (2) Tap the Multi icon  and then tap the file(s) /folder(s) that you want. You can select multiple items by tapping. To deselect the item(s), tap the Cancel icon .
- (3) Select "Copy" or "Move" from the pop-up menu.
- (4) Navigate to the location where you wish to copy or move the file/folder to.
- (5) Select the Edit icon  from the toolbar and then choose "Paste."

Delete Files and Folders

- (1) Navigate through the file/folder and locate the file/folder you want.
- (2) Tap the Multi icon  and then tap the file(s) /folder(s) that you want. You can select multiple items by tapping. To deselect the item(s), tap the Cancel icon .
- (3) Select "Delete" from the pop-up menu and then select "Delete" to confirm.

Compress Files/Folder with Zip

- (1) Navigate through the file/folder and locate the file/folder you want.
- (2) Tap the Multi icon  and then tap the file(s) /folder(s) that you want. You can select multiple items by tapping. To deselect the item(s), tap the Cancel icon .
- (3) Select "Zip" from the pop-up menu.
- (4) Enter a name for the zip file and then tap "Create".



File Options

You can hold your finger on a file or folder to display the options (as shown on the right).

Sending/Receiving E-mails

This device has an E-mail application pre-installed. You can send or receive e-mails from the Internet at any time with this device. Make sure you have an Internet connection before using the email service.

In the Home Screen, tap the Applications shortcut to display all applications and then tap the Email icon to launch the e-mail application.

Setup Email Account

First you need to setup an E-mail account for receiving or sending emails.

- (1) Start up the email application by tapping the **Email** application icon and you are

- prompted to setup an account.
- (2) Input your email address and login password. You can set the account as default by selecting the option "Send email from this account by default".
 - (3) Tap "Manual Setup" to set the email server information.
 - (4) Choose the server type from POP3, IMAP or Exchange for incoming emails. To know what type of your email server is, you can consult the service provider, network administrator or search for information in the Internet.
 - (5) Input required information (server, port etc.). You can obtain the information from the service provider, network administrator or the Internet.
 - (6) Choose the server type for outgoing emails, and input required server information.
 - (7) Click "Next" to continue. Your tablet will check the server settings. When it prompts you that "Your account is set up, and email is on its way", your account is set up successfully.
 - (8) Input your name and then tap on "Done" to finish.





Note: If you have more than one account, every time when you start up the email application, you enter the default email account.

Manage Accounts

You can setup more than one account and manage these accounts by checking information about the account, adding another account or deleting an account.

Add another Account

Following these steps to add another account if you want.

- (1) Launch the email application and then tap on the Menu icon  to display the menu item. Choose "Accounts" to display accounts.
- (2) Tap on the Menu icon  to display the menu item, and then choose "Add account".
- (3) Follow the steps of setting up a Email Account to add an account.

Delete an Email Account

- (1) When you are in the email box, tap on the Menu icon  to display the menu items.
- (2) Tap on "Accounts" to display all email accounts.
- (3) Hold your tap on the account that you want to delete until a menu pop up.
- (4) Tap on "Remove Account" , and then tap on "OK" to confirm.

Check the Account Setting

- (1) When you are in the email box, tap on the Menu icon  to display the menu items.
- (2) Tap on "Accounts" to display all email accounts.
- (3) Hold your tap on the account that you want to check until a menu pop up.
- (4) Tap "Account settings" , and then you should see all setting information about the

account. You can edit these settings as you want.

View Emails

You should enter your mailbox when you start up the email application.

- In the mailbox, you can slide your finger up and down to scroll through the email list.
- Tap on an email to open it.
- Holding your tap on the email can display a menu. With the menu, you can open, reply, forward or delete the email.

Email Menu Items

In the email list, tap on the Menu icon  to display the menu.

Refresh	Refresh the emails.
Compose	Compose a new email.
Folders	Go back to email box.
Accounts	View all email accounts.
Account Settings	Check your account settings.

Reading Office Documents

The device provides support to Microsoft Office document with its built-in OfficeSuite application. You can read documents in Word, Excel or PPT etc.

- (1) Copy Office documents to the device by USB connection.
- (2) Launch the OfficeSuite application.

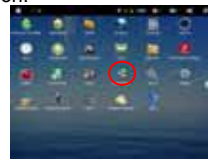

- (3) Locate an Office document with the file explorer.

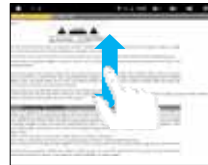

- (4) Tap the document to open it. On the opening page, you can slide your finger up and down to turn over the page.

- (5) You can tap the Menu icon to display menu options. With these options, you can search for specific texts or count words in the document.



Managing 3rd Party Applications

Your device provides support to many useful third-party applications. You can purchase the applications to add more functions to your device. They are available online at the Internet or directly on your product.

Pre-installed Applications

The device has pre-installed applications when it was manufactured. You can see them by tapping the Applications icon . They are video player, audio player, browser, alarm clock, calculator etc.

Install Applications

You can install applications manually following these steps:

- (1) Download the installation file directly from the built-in application library (e.g. SLIDEME). Make sure the file is in format of .apk which is supported by this device.
- (2) Connect your device to computer with the USB cable.
- (3) Copy the installation file to your Device.
- (4) Disconnect your device from the computer.
- (5) Turn on your device and enter the file explorer mode with the Explorer.
- (6) Locate the installation file and open it.
- (7) Follow the on-screen instructions to install the application.
- (8) Once the application is installed successfully, you can find it in the application tab.

Uninstall Applications

- (1) Tap the Settings shortcut in the Home Screen to display all system settings.
- (2) Select "Applications".
- (3) Select "Manage Applications".
- (4) Tap on the application that you want to uninstall.
- (5) Tap on "Uninstall" to uninstall the application.

Note:

- You cannot uninstall the pre-installed applications.
 - Some of the applications developed for Android mobile might not run properly in the Device. Please consult the respective software developer for further information.
-

Managing Tasks

Your device can handle multiple tasks at the same time. For example, you can view photos while listening to music. Multitasking is helpful but inefficient if too many tasks are running. In order to save system memory and enhance system performance, you can end some tasks that you don't use at the moment.

(1) Tap "Advanced Task Killer" application.

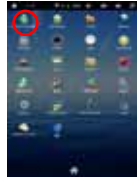

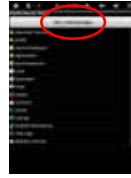

(2) Tap the task that you want to end.



(3) Tap "KILL selected apps" to end the task.

System Settings

In the Home screen, tap "**Settings**" and choose a category: "**Wireless & Networks,**" "**Sound & Display,**" "**Date & Time,**" etc.

- When a down arrow appears on the right of a parameter, this means that this setting includes sub-parameters. Tap it to display the list of sub-parameters.
- When a check box appears on the right of a parameter, tap it to enable or disable this option.
- When it is possible, you can use your finger to scroll the screen up and down to reveal settings that you don't initially see.
- When you have finished adjusting your settings, tap the Back icon  to go back to the list of settings, or tap the Home icon  to go directly to the Home screen. Your settings are saved instantly.

Troubleshooting

Reset this device

- In the event that the device freezes, you can force the device to shut down by holding the **Power** button for 15 seconds.
- If the **Power** button does not reset your device, use the "pinhole reset" button, located on the back the device.

Specifications

Item	Description
CPU	Based on Cortex-A8 Main CPU frequency : 1GHz
DDR	512MB/1GB (optional)
Built-in operating system	Android OS 2.3 or above
Hardware	IBM PC or compatible PC, Note-book or Macintosh with USB port
Internal Memory	4GB(1.2MB for internal system) or above
Memory Card type	SD card: 2GB, 4GB (SDHC), 8GB, 16GB, 32GB(SDHC)
Operation System	Windows2000/XP/Vista/windows 7/Linux2.4/ MAC OS 10.6.7 above
Interface	USB2.0 High speed

		SD (compatible SDHC)		
		3.5mm Earphone		
Connection Agreement		WiFi (802.11 b/g/n)		
G-sensor		Support 360 degrees rotation		
E-Book	File Format	PDF/EPUB/TXT/FB2/PDB/RTF		
	Coding Format	PDF / EPUB Format: .Open; .Adobe DRM (For License)		
		TXT / FB2/PDB/RTF Format: .Open		
Photo Format		JPEG(Baseline) : 2Mpels (Max) BMP GIF (Static) 1000x 1000 (Max.) PNG		
Audio	File Format	MP3/WAV/OGG/FLAC/APE/AAC/WMA		
	Coding Format	MP3 (MPEG1/2/2.5 Audio Layer 1/2/3) : 8 ~ 48KHZ/8 ~ 320Kbps,CBR and VBR		
		WMA (Version4, 4.1,7,8,9): 8 ~ 48KHZ		
		WAV (MS-ADPCM, IMA-ADPCM, PCM): 8 ~ 48KHZ		
		OGG (Q1- Q10): 8 ~ 48KHZ		
		FLAC(Compress Level 0 ~ 8): 8 ~ 48KHZ		
		APE (Version 3.95,3.97,3.98,3.99,normal and fast) : 8 ~ 48KHZ		
AAC(ADIF, ATDS Header AAC-LC and AAC-HE): 8 ~ 48KHZ				
Video	File Format	AVI, 3GP, MP4, RM, RMVB, FLV, MOV,		
	Coding Format	AVI(MPEG4,XVID,DIV X3/4/5/6, MS MPEG4 V3)	1920*1088pixels/30FPS (Max) Audio Codec : MP2/MP3/AC3/AAC/PCM	
		3GP/MP4(H.264,H.263 ,MPEG4,XVID,DIVX3/4 /5/6, MS MPEG4 V3)	MPEG4,XVID,DIVX3/4/5/6: 1920*1088pixels/30FPS (Max.) H.264: 1920*1088pixels/30FPS (Max) Audio Codec: MP2/MP3/AC3/AAC/PCM	
		RM/RMVB(Real video 8/9) :	1920*1088pixels/30FPS (Max) Audio Codec: Cook/AAC	
		FLV(Sorenson Spark)	1920*1088pixels/30FPS (Max) Audio Codec: MP3	
		MOV(H.264, H.263,MPEG4,XVID,DI VX3/4/5/6, MS MPEG4 V3)	MPEG4,XVID,DIVX3/4/5/6, MS MPEG4 V3: 1920*1088 pixels /30FPS/38.4Mbps(Max.) H.264: 1920*1088pixels/30FPS/20Mbps(Max) Audio Codec: MP2/MP3/AC3/AAC/AMR	
		MPG/DAT/VOB(MPEG1 /2)	1920*1088pixels/30FPS/80Mbps(Max.) Audio Codec: MP2/MP3	
		Read speed		8-9MB/S (MLC flash)
		Write speed		2.5-3.4MB/S (MLC flash)
		Battery Charge Time		About 5 Hours
Battery Life		About 7 hours of music playback; About 5 hours of video playback;		

	About 5-6 hours of web browsing.
Display	8.0-inch TFT LCD, Touchpad (capacitive touch pad), 800X480 pixels.
SNR	>=80dB
Frequency Response Range	20Hz--20KHz
Power Supply	Rechargeable lithium-ion polymer battery; AC Adapter: AC Input 100-240V ~ 50/60Hz, DC Output 5V/2A
Storage Temp.	-20 ~ +65
Ambient Temp.	0 ~ +50
Operation Relative Humidity	20% ~ 90% (40)
Storage Relative Humidity	20% ~ 93% (40)

FCC Statement

This equipment has been tested and found to comply with the limits for a Class B digital device, pursuant to Part 15 of the FCC Rules. These limits are designed to provide reasonable protection against harmful interference in a residential installation. This equipment generates, uses and can radiate radio frequency energy and, if not installed and used in accordance with the instructions, may cause harmful interference to radio communication. However, there is no guarantee that interference will not occur in a particular installation. If this equipment does cause harmful interference to radio or television reception, which can be determined by turning the equipment off and on, the user is encouraged to try to correct the interference by one or more of the following measures:

- Reorient or relocate the receiving antenna.
- Increase the separation between the equipment and receiver.
- Connect the equipment into an outlet on a circuit different from that to which the receiver is connected.
- Consult the dealer or an experienced radio/TV technician for help.

Caution: Any changes or modifications to this device not explicitly approved by manufacturer could void your authority to operate this equipment.

This device complies with Part 15 of the FCC Rules. Operation is subject to the following two conditions:

- (1) this device may not cause harmful interference, and
- (2) this device must accept any interference received, including interference that may cause undesired operation.

Changes or modifications not expressly approved by the party responsible for compliance could void the user's authority to operate the equipment.

FCC RF warning statement:

The device has been evaluated to meet general RF exposure requirement. The device can be used in portable exposure condition without restriction.

National Restrictions

This device is intended for home and office use in all EU countries (and other countries following the EU directive 1999/5/EC) without any limitation except for the countries mentioned below:

Country	Restriction	Reason/remark
France	Outdoor use limited to 10 mW e.i.r.p. within the band 2454-2483.5 MHz.	Military Radiolocation use. Refarming of the 2.4 GHz has been ongoing in recent years to allow current relaxed regulation. Full implementation planned 2012
Italy	None	For private use, a general authorisation is required if WAS/RLAN's are used outside own premises. For public use, a general authorisation is required
Norway	Implemented	This subsection does not apply for the geographical area within a radius of 20 km from the centre of Ny-Ålesund
Russian Federation	None	Indoor applications

RTTE Statement:

Hereby, [SHENZHEN YIFANG DIGITAL TECHNOLOGY CO., LTD. Building NO.22,23, Fifth Region, Baiwangxin Industrial Park, Songbai Rd., Nanshan, Shenzhen 518108, China] declares that this nextbook, Android MID M805HC is in compliance with the essential requirements and other relevant provisions of Directive 1999/5/EC.