 Thank you for
your purchase! 

(We hope you love your new air fryer as much as we do)

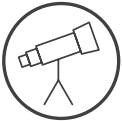

join

the Cosori Cooks Community on Facebook
facebook.com/groups/cosoricooks



explore

our recipe gallery
www.cosori.com/recipes



enjoy

weekly, featured recipes
made exclusively by our in-house chefs



CONTACT OUR CHEFS

Our helpful, in-house chefs are ready to assist you with any questions you might have!

Email: recipes@cosori.com

Toll-Free: (888) 402-1684

Mon–Fri, 9:00 am–5:00 pm PST/PDT

On behalf of all of us at Cosori,

Happy cooking!

Table of Contents

Package Contents	3
Specifications	3
Important Safeguards	4
VeSync App Setup	7
VeSync App Features	7
Getting To Know Your Air Fryer	8
Before First Use	10
Using Your Air Fryer	11
Care & Maintenance	15
Accessories	15
Troubleshooting	16
Warranty Information	18
Customer Support	19

Package Contents

- 1 x Dual Blaze™ 6.8-Quart Air Fryer
- 1 x User Manual

Specifications

Power Supply	AC 120V, 60Hz
Rated Power	1750W
Capacity	6.8 qt / 6.4 L (serves 4–6 people)
Temperature Range	175°F–400°F / 80°C–205°C
Time Range	1–60 min
Dimensions	11.7 x 12.9 x 13.8 in / 29.7 x 32.7 x 35.2 cm
Weight	13.7 lb / 6.22 kg

Download the free VeSync app to access smart functions, original recipes from the Cosori chefs, and more!



READ AND SAVE THESE INSTRUCTIONS

IMPORTANT SAFEGUARDS

Follow basic safety precautions when using your air fryer. Read all instructions.

Key Safety Points

- **Do not** touch hot surfaces. Use handle.
- Use caution when turning the basket over after cooking, as the hot crisper plate may fall out and create a safety hazard.
- **Do not** block any ventilation openings. Hot steam is released through openings. Keep your hands and face clear of openings.

General Safety

- **Do not** immerse the air fryer housing, cord, or plug in water or other liquid.
- Closely supervise children near your air fryer.
- Unplug when not in use, and before cleaning. Allow to cool before putting on or taking off parts.
- **Do not** use your air fryer if it is damaged, not working, or if the cord or plug is damaged. Contact **Customer Support** (see page 19).
- **Do not** use third-party replacement parts or accessories, as this may cause injuries.
- **Do not** use outdoors.
- **Do not** place the air fryer or any of its parts on a stove, near gas or electric burners, or in a heated oven.
- Be extremely cautious when moving your air fryer (or removing the basket) if it contains hot oil or other hot liquids.

- **Always** place the crisper plate on a heat-resistant surface after removing it from the basket.
- **Do not** clean with metal scouring pads. Metal fragments can break off the pad and touch electrical parts, creating a risk of electric shock.
- **Do not** place anything on top of your air fryer. **Do not** store anything inside your air fryer.
- This air fryer is not intended for use by persons (including children) with reduced physical, sensory, or mental capabilities, or lack of experience and knowledge, unless they have been given supervision or instruction concerning use of the air fryer by a person responsible for their safety.
- Cleaning and user maintenance should not be done by children without supervision.
- **Only** use your air fryer as directed in this manual.
- Not for commercial use. Household use **only**.

While Air Frying

- An air fryer works with hot air only. **Never** fill the basket with oil or fat.
- **Never** use your air fryer without the basket in place.
- **Do not** place oversized foods or metal utensils into your air fryer.
- **Do not** overfill the air fryer basket. Heaping amounts of food may touch the heating coils and cause a fire hazard.

- **Do not** touch accessories (including the crisper plate) during or immediately after air frying.
- **Do not** place paper, cardboard, non-heat-resistant plastic, or similar materials, into your air fryer.
- **Never** put baking or parchment paper into the air fryer without food on top. Air circulation can cause paper to lift and touch heating coils.
- **Always** use heat-safe containers. Be extremely cautious if using containers that aren't metal or glass.
- Keep your air fryer away from flammable materials (curtains, tablecloths, etc.). Use on a flat, stable, heat-resistant surface away from heat sources or liquids.
- Immediately turn off and unplug your air fryer if you see dark smoke coming out. White smoke is normal, caused by heating fat or food splashing, but dark smoke means that food is burning or there is a circuit problem. Wait for the smoke to clear before pulling the basket out. If the cause was not burnt food, contact **Customer Support** (page 19).
- **Do not** leave your air fryer unattended while in use.
- To turn the air fryer off, press the On/Off button (⏻) once. The air fryer will beep, and all buttons will shut off except the On/Off button, which will turn orange.

Power & Cord

- Your air fryer has a polarized plug (one prong is wider than the other), which fits into a polarized outlet only one way. If the plug does not fit, reverse the plug. If it still does not fit, **do not** use the plug in that outlet. **Do not** alter the plug in any way.
- Always attach the plug to the air fryer before plugging the cord into the outlet. Turn off the air fryer before removing the plug from the outlet.
- **Do not** let the power cord (or any extension cord) hang over the edge of a table or counter, or touch hot surfaces.
- Remove and discard the protective cover fitted over the power plug of the air fryer to prevent a choking hazard.
- Keep the air fryer and its cord out of reach of children
- **Never** use an outlet below the counter when plugging in your air fryer.
- Your air fryer should only be used with **120V, 60Hz** electrical systems and a grounded outlet. **Do not** plug into another type of outlet.
- A short power-supply cord is provided to reduce the risk resulting from becoming entangled in or tripping over a longer cord.

- Longer extension cords are available and may be used if care is exercised in their use. If a longer extension cord is used:
 - The marked electrical rating of the extension cord should be at least as great as the electrical rating of the air fryer.
 - The cord should be arranged so that it will not drape over the countertop or tabletop where it can be pulled on by children or tripped over unintentionally.
- If the power supply cord is damaged, it must be replaced by Arovast or similarly qualified persons in order to avoid an electric or fire hazard. Please contact **Customer Support** (page 19).

Electromagnetic Fields (EMF)

The Cosori Air Fryer complies with all standards regarding electromagnetic fields (EMF). If handled properly and according to the instructions in this user manual, the appliance is safe to use based on scientific evidence available today.

SAVE THESE INSTRUCTIONS

VeSync App Setup

Note: *The VeSync app is continually being improved and may change over time. If there are any differences, follow the in-app instructions.*

1. To download the VeSync app, scan the QR code or search “VeSync” in the Apple App Store® or Google Play Store.

Note: *For Android™ users, choose “Allow” to use VeSync.*



2. Open the VeSync app. If you already have an account, tap **Log In**. To create a new account, tap **Sign Up**.

Note: *You must create your own VeSync account to use third-party services and products. These will not work with a guest account. With a VeSync account, you can also allow your family and friends to control your smart air fryer.*

3. Tap **+** and select your smart air fryer.
4. Follow the in-app instructions to set up your smart air fryer.

Note:

- You can change the name and icon at any time by going to the smart air fryer screen and tapping .
- You can use the VeSync app to connect your smart air fryer to **Amazon Alexa** or **Google Assistant™**.

Disconnecting From WiFi:

- To disconnect Wi-Fi®, press and hold the  for 15 seconds until the Wi-Fi indicator turns off. This will restore the smart air fryer’s default settings and disconnect it from the VeSync app.
- To reconnect, please follow the instructions in the VeSync app for adding a device.

VeSync App Features

The VeSync app allows you to access additional smart air fryer functions, including those listed below.

Remote Control

- All smart air fryer functions can be controlled remotely, except for starting cooking (to comply with UL safety regulations).
- Cooking progress can be monitored from a distance.

In-App Recipes

- Pre-programmed recipes made by Cosori’s in-house chefs are available on the app. These recipes automatically set the recommended time and temperature.
- Create and save custom recipes.

Third-Party Voice Control

- Compatible with Amazon Alexa and Google Assistant™ for voice commands.

Note: *The VeSync app is continually updated and app features will expand.*

GETTING TO KNOW YOUR AIR FRYER

Your Cosori Air Fryer uses rapid 360 Thermo IQ™ Technology to cook with little to no oil for quick, crispy, delicious food with up to 85% fewer calories than deep fryers. With user-friendly one-touch controls, a nonstick basket, and an intuitive, safe design, the Cosori Air Fryer is the star of your kitchen.

Note:

- **Do not** try to open the top of the air fryer. This is not a lid.
- The basket and crisper plate are made of aluminum metal with nonstick coating.

Air Fryer Diagram

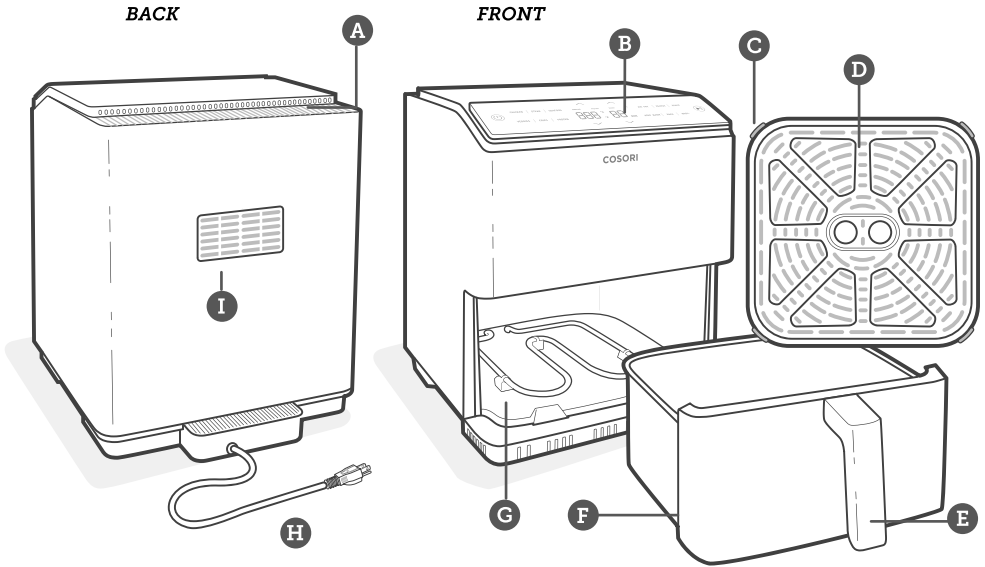

A. Air Inlet

B. Control Screen

C. Rubber Stoppers

D. Crisper Plate

E. Basket Handle

F. Basket

G. Heating Elements

H. Power Cord

I. Air Outlet

Display Diagram

Note: When you press a button to use a function or program, it will turn white to show that it's active.

Control Panel

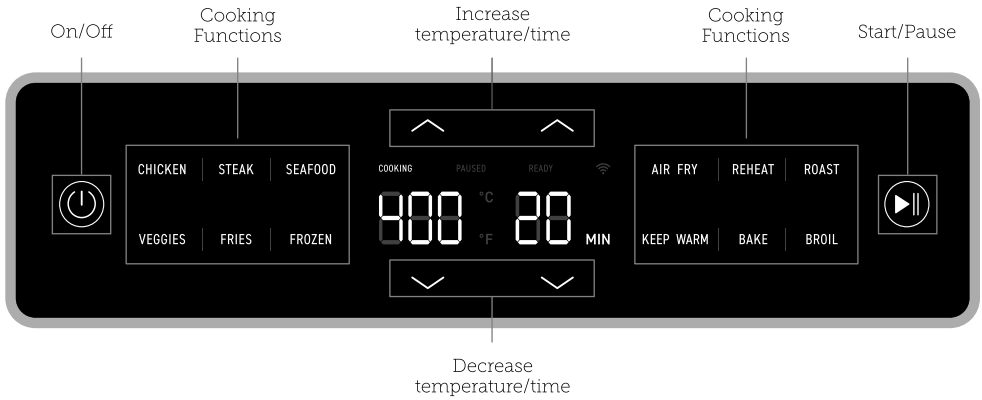

Note:

- To save or reset presets, see **Cooking Functions** (see page 12).
- Press and hold  for 5 seconds to configure your air fryer. See the VeSync in-app instructions for more information.



Note: The Wi-Fi® indicator tells you your VeSync configuration status. See the VeSync in-app instructions for more information.

Display Messages



Ready



Cooking



Paused

BEFORE FIRST USE

Setting Up

1. Remove and discard all packaging from the air fryer, including any temporary stickers and the protective cover fitted over the power plug.
2. Place the air fryer on a stable, level, heat-resistant surface. Keep away from areas that can be damaged by steam (such as walls or cupboards).

Note: Leave 5 inches / 13 cm of space behind and above the air fryer. [Figure 1.1] Leave enough room to remove the basket.

3. Wash both the basket and crisper plate thoroughly, using either a dishwasher or a non-abrasive sponge.
4. Wipe the inside and outside of the air fryer with a slightly moist cloth. Dry with a towel.
5. Insert the crisper plate back into the basket, and place the basket inside the air fryer.

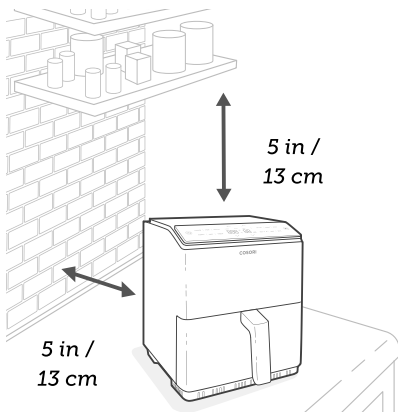

Figure 1.1

Test Run

A test run will help you become familiar with your air fryer, make sure it's working correctly, and clean it of possible residues in the process.

1. Make sure the air fryer basket is empty and plug in the air fryer.
2. Press **AIR FRY**. The display will show "400°F" and "20 MIN".
3. Press and hold the \checkmark button under the time to change the time to 10 minutes.
4. Press **▶||** to begin. When finished, the air fryer will beep.
5. Remove the basket. Let the basket cool completely for 10–30 minutes.

Note:

- Use caution when turning the basket over after cooking, as the hot crisper plate may fall out and create a safety hazard.
- **Do not** unscrew the basket handle from the basket.

Rubber Stoppers

- The crisper plate contains 4 rubber stoppers made of food-safe material. These stoppers keep the plate fitted to the bottom of the basket.
- If the rubber stoppers are removed, the crisper plate may damage the nonstick coating on the basket.
- **Only** remove the rubber stoppers for cleaning purposes. For easy removal, start from the bottom of the crisper plate and pull out one side of the stopper at a time. **[Figure 1.2]**
- To place the rubber stoppers back onto the crisper plate, first soak them in water. Then, push each stopper back in through the bottom of the crisper plate. Push in one side of the stopper at a time.
- Make sure children do not play with the rubber stoppers or swallow them.

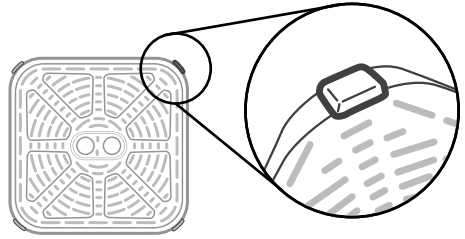

Figure 1.2

USING YOUR AIR FRYER

You can use the VeSync app to monitor cooking, follow in-app recipes, and access additional features. For a list of smart features, see **VeSync App Features** (see page 7)

Note:

- **Do not** place anything on top of your air fryer. This will disrupt airflow and cause poor air frying results. **[Figure 2.1]**
- An air fryer is not a deep fryer. **Do not** fill the baskets with oil, frying fat, or any liquid.
- When taking the basket out of the air fryer, be careful of hot steam.

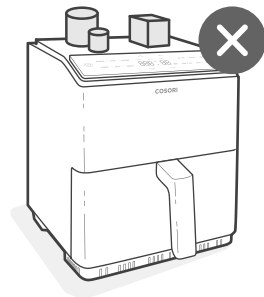



Figure 2.1

Cooking Functions

Using a cooking function is the easiest way to air fry. Cooking functions are programmed with an ideal time and temperature for cooking certain foods.

1. Press the function's button to select the function. The air fryer will automatically change to the function's default settings.
2. You can customize a cooking function's time (1–60 minutes) and temperature (175°–450°F). To go back to a function's default settings right after changing them, press the function's icon again.

- To save a cooking function:
 - a. Choose a preset and adjust the time and temperature.
Note: Press and hold the  or  buttons to rapidly increase or decrease the time or temperature.
 - b. Press and hold the cooking function icon for 3 seconds.
- To reset all cooking functions:

Note: Results may vary. Check out our Recipe Book for a guide to using cooking functions for perfect results.

Function	Default Temperature	Default Time (Minutes)
Chicken	390°F / 200°C	20
Steak	400°F / 205°C	8
Seafood	375°F / 190°C	8
Veggies	385°F / 195°C	6
Fries*	385°F / 195°C	20
Frozen	395°F / 200°C	12
Air Fry	360°F / 180°C	10
Reheat	350°F / 175°C	5
Roast	400°F / 205°C	10
Keep Warm	175°F / 80°C	30
Bake	320°F / 160°C	20
Broil	400°F / 205°C	10

* See **Cooking Tips** (page 13) for more tips on air frying French fries.

Air Frying

1. Plug in. When your air fryer displays **READY**, add food to the basket.
 - For the best results, add the crisper plate into the basket to allow excess oil to drip down to the bottom of the basket.
2. Select a cooking function (see page 12).

Note: *Cooking functions are programmed with an ideal time and temperature for cooking certain foods. The air fryer will default to the Air Fry function if no other cooking function is selected.*
3. Optionally, change the temperature and time. You can do this anytime during cooking.
 - Press the \sphericalangle or \sphericalangle buttons to change the temperature (175°–400°F / 80°–205°C) or time (1–60 minutes).
4. Press **▶||** to begin air frying.
5. The air fryer will beep 3 times when finished. The display will show



- Optionally, press **Keep Warm**. Press the \sphericalangle or \sphericalangle buttons to change the time (1–60 minutes).
6. Remove the contents from the basket using silicone-tipped tongs or other utensils.
 7. Allow to cool before cleaning.

Cooking Tips

Overfilling

- If the basket is overfilled, food will cook unevenly.

Using Oil

- Adding a small amount of oil to your food will make it crispier. Use no more than 2 US tbsp / 30 mL of oil.
- Oil sprays are excellent for applying small amounts of oil evenly to all food items.

Food Tips

- You can air fry any frozen foods or goods that can be baked in an oven.
- To make cakes, hand pies, or any food with filling or batter, place food in a heat-safe container before placing in the basket.
- Air frying high-fat foods will cause fat to collect underneath the crisper plate. To avoid excess smoke while cooking, pour out fat drippings after cooking.
- Liquid-marinated foods create splatter and excess smoke. Pat these foods dry before air frying.



French Fries

- Add ½–1 US tbsp / 8–15 mL oil for crispiness.
- When making fries from raw potatoes, soak uncooked fries in water for 15 minutes to remove starch prior to frying. Pat dry with a towel before adding oil.
- Cut uncooked fries smaller for crispier results. Try cutting fries into ¼- by 3-inch / 0.6- by 7.6-cm strips.



Note: *For more tips and recipes, check out the VeSync app and Cosori website.*

More Functions

Switching Temperature Units

- Press and hold **Temp**  and  for 3 second.
- The temperature unit will change from Fahrenheit to Celsius.
- Repeat to switch back to Fahrenheit.

Pausing

- Press  to pause cooking. The air fryer will stop heating, and  will blink until you press  again to resume cooking.
- After 30 minutes of inactivity, the air fryer will turn off.
- This function allows you to pause the cooking program without removing the baskets from the air fryer.

Automatically Resume Cooking

- If you pull out the basket, the air fryer will pause cooking automatically. The display will turn off temporarily as a safety feature.
- When you return the basket, the air fryer will automatically resume cooking based on your previous settings.

Automatic Shutoff

- If the air fryer has no active cooking programs, the air fryer will clear all settings and turn off after 3 minutes of inactivity.

Overheat Protection

- If the air fryer overheats, it will automatically shut down as a safety feature.
- Let the air fryer cool down completely before using it again.

CARE & MAINTENANCE

Note:

- **Always** clean the air fryer basket and crisper plate after every use.
 - Lining the basket with foil (except the crisper plate) may make cleanup easier.
1. Turn off and unplug the air fryer. Allow it to cool completely before cleaning. Pull out the basket for faster cooling.
 2. Wipe the outside of the air fryer with a moist cloth, if necessary.
 3. The basket and crisper plate are dishwasher safe. You can also wash the basket and crisper plate with hot, soapy water and a non-abrasive sponge. Soak if necessary.

Note: The basket and crisper plate have a nonstick coating. Avoid using metal utensils and abrasive cleaning materials.

4. For stubborn grease:
 - a. In a small bowl, mix 2 US tbsp / 30 mL of baking soda and 1 US tbsp / 15 mL of water to form a spreadable paste.

- b. Use a sponge to spread the paste on the basket and crisper plate and scrub. Let the basket and crisper plate sit for 15 minutes before rinsing.
 - c. Wash basket with soap and water before using.
5. Clean the inside of the air fryer with a slightly moist, non-abrasive sponge or cloth. **Do not** immerse in water. If needed, clean the heating coil to remove food debris. [Figure 3.1]
6. Dry before using.

Note: Make sure the heating coil is completely dry before turning on the air fryer.

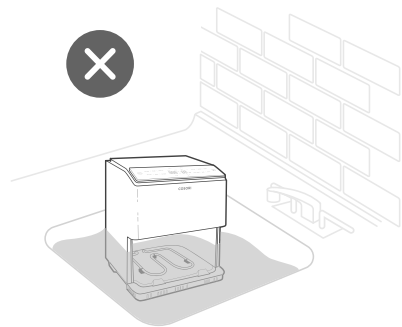

Figure 3.1

ACCESSORIES

Additional and replacement accessories are available for your air fryer. For more information, contact **Customer Support** (see page 19).

TROUBLESHOOTING

Problem	Possible Solution
The air fryer will not turn on.	Make sure the air fryer is plugged in.
	Push the basket securely into the air fryer.
Foods are not completely cooked.	Place smaller batches of food items into the basket. If the basket is overstuffed, then foods will be undercooked.
	Increase cooking temperature or time.
Foods are not crispy after air frying.	Spraying or brushing a small amount of oil on foods can increase crispiness (see Cooking Tips , page 13)
French fries are not cooked correctly.	See French Fries , page 13.
Basket will not slide into the air fryer securely.	Make sure the basket is not overfilled with food.
White smoke or steam is coming out of the air fryer.	The air fryer may produce some white smoke or steam when you use it for the first time or during cooking. This is normal.
	Make sure the basket and the inside of the air fryer are cleaned properly and not greasy.
	Cooking greasy foods will cause oil to collect beneath the crisper plate. This oil will produce white smoke, and the basket may be hotter than usual. This is normal and should not affect cooking. Handle the basket with care.
Dark smoke is coming out of the air fryer.	Immediately unplug your air fryer. Dark smoke means that food is burning or there is a circuit problem. Wait for smoke to clear before pulling the basket out. If the cause was not burnt food, contact Customer Support (see page 19).
The air fryer has a plastic smell.	Any air fryer may have a plastic smell from the manufacturing process. This is normal. Follow the instructions for a Test Run (page 10) to get rid of the plastic smell. If a plastic smell is still present, please contact Customer Support (see page 19).
Display shows Error Code "E1".	There is an open circuit in the temperature monitor. Contact Customer Support (see page 19).
Display shows Error Code "E2".	There is a short circuit in the temperature monitor. Contact Customer Support (see page 19).
Display shows Error Code "E3".	The air fryer's overheat protection has activated. Turn off and unplug the air fryer and allow it to cool completely. If the display continues to show "E3", contact Customer Support (see page 19).
Display shows Error Code "E4".	The air fryer has been plugged into a 220–240V outlet. Turn off and unplug the air fryer. Only use the air fryer with 120V, 60Hz outlets.

If your problem is not listed, please contact **Customer Support** (see page 19).

FEDERAL COMMUNICATION COMMISSION INTERFERENCE STATEMENT - PART 15

This device complies with Part 15 of the FCC Rules. Operation is subject to the following two conditions:

1. This device may not cause harmful interference, and
2. This device must accept any interference received, including interference that may cause undesired operation.

NOTE: This equipment has been tested and found to comply with the limits for a Class B digital device, pursuant to Part 15 of the FCC Rules. These limits are designed to provide reasonable protection against harmful interference in a residential installation. This equipment generates, uses and can radiate radio frequency energy and, if not installed and used in accordance with the instructions, may cause harmful interference to radio communications. However, there is no guarantee that interference will not occur in a particular installation. If this equipment does cause harmful interference to radio or television reception, which can be determined by turning the equipment off and on, the user is encouraged to try to correct the interference by one or more of the following measures:

- Reorient or relocate the receiving antenna.
- Increase the separation between the equipment and receiver.
- Connect the equipment into an outlet on a circuit different from that to which the receiver is connected.
- Consult the dealer or an experienced radio/TV technician for help.

FCC Caution: Any changes or modifications not expressly approved by the party responsible for compliance could void the user's authority to operate this equipment.

FCC RADIATION EXPOSURE STATEMENT

This equipment complies with FCC radiation exposure limits set forth for an uncontrolled environment. End users must follow the specific operating instructions for satisfying RF exposure compliance. To maintain compliance with FCC RF exposure compliance requirements, please follow operation instructions as documented in this manual. This transmitter must not be co-located or operating in conjunction with any other antenna or transmitter. This equipment should be installed and operated with a minimum distance of 20 cm between the radiator and your body. The availability of some specific channels and/or operational frequency bands are country dependent and are firmware programmed at the factory to match the intended destination. The firmware setting is not accessible by the end user.

WARRANTY INFORMATION

Product Name	Dual Blaze™ 6.8-Quart Air Fryer
Model	CAF-P583S-KUS
<i>For your own reference, we strongly recommend that you record your order ID and date of purchase.</i>	
Date of Purchase	
Order ID	

TERMS & POLICY

Arovast Corporation (“Arovast”) warrants this product to the original purchaser to be free from defects in material and workmanship, under normal use and conditions, for a period of 2 years from the date of original purchase.

Arovast agrees, at our option during the warranty period, to repair any defect in material or workmanship or furnish an equal product in exchange without charge, subject to verification of the defect or malfunction and proof of the date of purchase.

There is no other express warranty. This warranty does not apply:

- If the product has been modified from its original condition;
- If the product has not been used in accordance with directions and instructions in the user manual;
- To damages or defects caused by accident, abuse, misuse or improper or inadequate maintenance;
- To damages or defects caused by service or repair of the product performed by an unauthorized service provider or by anyone other than Arovast;
- To damages or defects occurring during commercial use, rental use, or any use for which the product is not intended;
- To damages or defects exceeding the cost of the product.

Arovast will not be liable for indirect, incidental, or consequential damages in connection with the use of the product covered by this warranty.

This warranty extends only to the original consumer purchaser of the product and is not transferable to any subsequent owner of the product regardless of whether the product is transferred during the specified term of the warranty.

This warranty does not extend to products purchased from unauthorized sellers. Arovast’s warranty extends only to products purchased from authorized sellers that are subject to Arovast’s quality controls and have agreed to follow its quality controls.

All implied warranties are limited to the period of this limited warranty.

This warranty gives you specific legal rights and you may also have other rights which vary from state to state. Some states do not allow the exclusion or limitation of incidental or consequential damages, so the above limitation or exclusion may not apply to you.

If you discover that your product is defective within the specified warranty period, please contact Customer Support via **support@cosori.com**. **DO NOT** dispose of your product before contacting us. Once our Customer Support Team has approved your request, please return the product with a copy of the invoice and order ID.

Every Cosori product automatically includes a 2-year warranty. To make the customer support process quick and easy, register your product online at www.cosori.com/warranty.

This warranty is made by:

Arovast Corporation
1202 N. Miller St., Suite A
Anaheim, CA 92806

CUSTOMER SUPPORT

If you have any questions or concerns about your new product, please contact our helpful Customer Support Team.

Arovast Corporation

1202 N. Miller St., Suite A
Anaheim, CA 92806

Email: support@cosori.com

Toll-Free: (888) 402-1684

Support Hours

Mon–Fri, 9:00 am–5:00 pm PST/PDT

**Please have your invoice and order ID ready before contacting Customer Support.*

Attributions

Amazon, Alexa, and all related logos are trademarks of Amazon.com, Inc. or its affiliates.

Google, Android, and Google Play are trademarks of Google LLC.

Apple App Store is a trademark of Apple Inc.

Wi-Fi® is a registered trademark of Wi-Fi Alliance®.

iOS is a registered trademark of Cisco Systems, Inc. and/or its affiliates in the United States and certain other countries.

The Bluetooth® word mark and logos are registered trademarks owned by Bluetooth SIG, Inc. and any use of such marks by Arovast Corporation is under license.

Other trademarks and trade names are those of their respective owners.

SHOW US WHAT YOU'RE MAKING

We hope this has been helpful to you. We can't wait to see your beautiful results, and we think you'll want to share glam shots! Our community awaits your uploads—just pick your platform of choice below. Snap, tag, and hashtag away, Cosori chef!

#LiveLifeTastefully #iCookCosori

@CosoriCooks



@Cosori



MORE COSORI RECIPES

Considering what to cook? Many recipe ideas are available, both from us, the Cosori community, and through the VeSync app.



Scan the QR code
to get the app.

COSORI®

Questions or Concerns?

Mon-Fri, 9:00 am-5:00 pm PST/PDT
support@cosori.com | (888) 402-1684