



User Guide

DCX3200-M P3

High-Definition Digital STB



MOTOROLA and the Stylized M logo are trademarks or registered trademarks of Motorola Trademark Holdings, LLC. CableCARD™, M-Card™, and DOCSIS® are trademarks or registered trademarks of Cable Television Laboratories, Inc. HDMI, the HDMI Logo and High Definition Multimedia Interface are trademarks or registered trademarks of HDMI Licensing LLC. Dolby and the double-D symbol are registered trademarks of Dolby Laboratories. Macrovision® is a registered trademark of Rovi Corporation. . All other product or service names are the property of their respective owners. ©2011 Motorola Mobility, Inc. All rights reserved.

© Copyright 2011 Multimedia over Coax Alliance. All Rights Reserved. MoCA and the MoCA logo is a trademark of Multimedia over Coax Alliance. The Multimedia over Coax Alliance (MoCA), www.mocalliance.org, is an open, standard body promoting networking of digital video and entertainment through existing coaxial cable in the home.

No part of this publication may be reproduced in any form or by any means or used to make any derivative work (such as translation, transformation, or adaptation) without written permission from Motorola, Inc. Motorola reserves the right to revise this publication and to make changes in content from time to time without obligation on the part of Motorola to provide notification of such revision or change. Motorola provides this guide without warranty of any kind, implied or expressed, including, but not limited to, the implied warranties of merchantability and fitness for a particular purpose. Motorola may make improvements or changes in the product(s) described in this manual at any time.



Important Safety Instructions

IMPORTANT SAFETY INSTRUCTIONS

- Read these instructions.
- Keep these instructions.
- Heed all warnings.
- Follow all instructions.
- Do not use this apparatus near water.
- Clean only with dry cloth.
- Do not block any ventilation openings. Install in accordance with the manufacturer's instructions.
- Do not install near any heat sources such as radiators, heat registers, stoves, or other apparatus (including amplifiers) that produce heat.
- Do not defeat the safety purpose of the polarized or grounding-type plug. A polarized plug has two blades with one wider than the other. A grounding type plug has two blades and a third grounding prong. The wide blade or the third prong is provided for your safety. If the provided plug does not fit into your outlet, consult an electrician for replacement of the obsolete outlet.
- Protect the power cord from being walked on or pinched particularly at plugs, convenience receptacles, and the point where they exit from the apparatus.
- Only use attachments/accessories specified by the manufacturer.
- Unplug this apparatus during lightning storms or when unused for long periods of time.
- Refer all servicing to qualified service personnel. Servicing is required when the apparatus has been damaged in any way, such as the power-supply cord or plug is damaged, liquid has been spilled or objects have fallen into the apparatus, the apparatus has been exposed to rain or moisture, does not operate normally, or has been dropped.



Important Safety Considerations

- The main plug is the main disconnect device. It shall remain readily accessible and operable.
- The apparatus shall not be exposed to dripping or splashing and no objects filled with liquids, such as vases, shall be placed on the apparatus.

During Transportation to the Subscriber Home

- Transport the cable terminal in its shipping box or an equally padded container.
- Do not expose the terminal to rain or moisture.



During Installation

- Do not place the terminal in an enclosed area where the cooling vents are blocked or impede the flow of air through the ventilation openings.
- Install the terminal so that its position does not interfere with its proper ventilation. For example, do not place the terminal on a bed, sofa, rug, or similar surface that could block the ventilation openings.
- Install the terminal away from heat sources such as radiators, heat registers and stoves. Installation of the terminal near consumer electronics devices, such as stereo receiver/amplifiers and televisions, is permitted as long as the air surrounding the terminal does not exceed 40° C (104° F).
- Place the terminal on a flat surface not prone to vibration or impact.
- Do not install the terminal in an area where condensation occurs.
- To prevent the temporary loss of guide data and cause a temporarily non-responding terminal, do not plug the AC power cord into a switched power outlet.



FCC Compliance

Note: This equipment has been tested and found to comply with the limits for a Class B digital device, pursuant to part 15 of the FCC Rules. These limits are designed to provide reasonable protection against harmful interference in a residential installation. This equipment generates, uses, and can radiate radio frequency energy and, if not installed and used in accordance with the instructions, may cause harmful interference to radio communications. However, there is no guarantee that interference will not occur in a particular installation. If this equipment does cause harmful interference to radio or television reception, which can be determined by turning the equipment off and on, the user is encouraged to try to correct the interference by one or more of the following measures:

- Reorient or relocate the receiving antenna.
- Increase the separation between the equipment and receiver.
- Connect the equipment into an outlet on a circuit different from that to which the receiver is connected.
- Consult the dealer or an experienced radio/TV technician for help.

Caution: Changes or modifications not expressly approved by Motorola for compliance could void the user's authority to operate the equipment.

This device complies with part 15 of the FCC Rules. Operation is subject to the following two conditions: one This device may not cause harmful interference, and (2) this device must accept any interference received, including interference that may cause undesired operation.

FCC Declaration of Conformity

Motorola Mobility, Inc. 101 Tournament Drive, Horsham, PA 19044, 1-215-323-1000, declares that the DCX3200-M set-top complies with 47 CFR Parts 2 and 15 of the FCC rules as a Class B digital device.

Industry Canada (IC)

This Class B digital device complies with Canadian ICES-003.

Cet appareil numérique de la classe B est conforme à la norme NMB-003 du Canada.

Caring for the Environment by Recycling

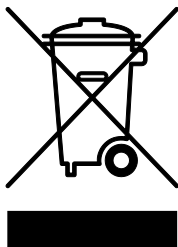

When you see this symbol on a Motorola product, do not dispose of the product with residential or commercial waste.

Recycling your Motorola Equipment

Please do not dispose of this product with your residential or commercial waste. Some countries or regions, such as the European Union, have set up systems to collect and recycle electrical and electronic waste items. Contact your local authorities for information about practices established for your region. If collection systems are not available, call Motorola Customer Service for assistance.



Software License

IMPORTANT: PLEASE READ THIS SOFTWARE LICENSE (“LICENSE”) CAREFULLY BEFORE YOU USE ANY SOFTWARE, FIRMWARE AND RELATED DOCUMENTATION (“SOFTWARE”) PROVIDED WITH MOTOROLA’S DIGITAL CABLE RECEIVER OR HOME THEATER SYSTEM (EACH SHALL BE REFERRED TO IN THIS LICENSE AS A “RECEIVER”). BY USING THE RECEIVER AND/OR USING ANY OF THE SOFTWARE, YOU INDICATE YOUR ACCEPTANCE OF EACH OF THE TERMS OF THIS LICENSE. UPON ACCEPTANCE, THIS LICENSE WILL BE A LEGALLY BINDING AGREEMENT BETWEEN YOU AND MOTOROLA. THE TERMS OF THIS LICENSE APPLY TO YOU AND TO ANY SUBSEQUENT USER OF THIS SOFTWARE.

IF YOU DO NOT AGREE TO ALL OF THE TERMS OF THIS LICENSE (I) DO NOT USE THE SOFTWARE AND (II) RETURN THE RECEIVER AND THE SOFTWARE (COLLECTIVELY, “PRODUCT”), INCLUDING ALL COMPONENTS, DOCUMENTATION AND ANY OTHER MATERIALS PROVIDED WITH THE PRODUCT, TO YOUR POINT OF PURCHASE OR SERVICE PROVIDER, AS THE CASE MAY BE, FOR A FULL REFUND.

The Software includes associated media, any printed materials, and any “on-line” or electronic documentation. Software provided by third parties may be subject to separate end-user license agreements from the manufacturers of such Software. The Software is never sold. Motorola licenses the Software to the original customer and to any subsequent licensee for personal use only on the terms of this License. Motorola and its third party licensors retain the ownership of the Software.

You may:

USE the Software only in connection with the operation of the Product.

TRANSFER the Software (including all component parts and printed materials) permanently to another person, but only if the person agrees to accept all of the terms of this License. If you transfer the Software, you must at the same time transfer the Product and all copies of the Software (if applicable) to the same person or destroy any copies not transferred.

TERMINATE this License by destroying the original and all copies of the Software (if applicable) in whatever form.

You may not:

one Loan, distribute, rent, lease, give, sublicense or otherwise transfer the Software, in whole or in part, to any other person, except as permitted under the TRANSFER paragraph above. (2) Copy or translate the User Guide included with the Software, other than for personal use. (3) Copy, alter, translate, decompile, disassemble or reverse engineer the Software, including but not limited to, modifying the Software to make it operate on non-compatible hardware. (4) Remove, alter or cause not to be displayed, any copyright notices or startup message contained in the Software programs or documentation. (5) Export the Software or the Product components in violation of any United States export laws.

The Product is not designed or intended for use in on-line control of aircraft, air traffic, aircraft navigation or aircraft communications; or in design, construction, operation or maintenance of any nuclear facility. MOTOROLA AND ITS THIRD PARTY LICENSORS DISCLAIM ANY EXPRESS OR IMPLIED WARRANTY OF FITNESS FOR SUCH USES. YOU REPRESENT AND WARRANT THAT YOU SHALL NOT USE THE PRODUCT FOR SUCH PURPOSES.

Title to this Software, including the ownership of all copyrights, mask work rights, patents, trademarks and all other intellectual property rights subsisting in the foregoing, and all adaptations to and modifications of the foregoing shall at all times remain with Motorola and its third party licensors. Motorola retains all rights not expressly licensed under this License. The Software, including any images, graphics, photographs, animation, video, audio, music and text incorporated therein is owned by Motorola or its third party licensors and is protected by United States copyright laws and international treaty provisions. Except as otherwise expressly provided in this License, the copying, reproduction, distribution or preparation of derivative works of the Software, any portion of the Product or the documentation is



strictly prohibited by such laws and treaty provisions. Nothing in this License constitutes a waiver of Motorola's rights under United States copyright law.

This License and your rights regarding any matter it addresses are governed by the laws of the Commonwealth of Pennsylvania, without reference to conflict of laws principles. THIS LICENSE SHALL TERMINATE AUTOMATICALLY if you fail to comply with the terms of this License.

Motorola is not responsible for any third party software that is provided as a bundled application, or otherwise, with the Software or that is downloaded to, or otherwise installed on, the Product.

U.S. GOVERNMENT RESTRICTED RIGHTS

The Product and documentation is provided with RESTRICTED RIGHTS. The use, duplication or disclosure by the Government is subject to restrictions as set forth in subdivision (c)(1)(ii) of The Rights in Technical Data and Computer Software clause at 52.227-7013. The contractor/manufacturer is Motorola Mobility, Inc. 101 Tournament Drive, Horsham, PA 19044.



Contents

Important Safety Instructions	i
Software License	iv
Tables	2
Figures	2
Introduction	3
Front Panel.....	4
Rear Panel.....	5
Operation	6
Turning Power On and Off.....	6
Changing Channels.....	6
Adjusting the Volume.....	6
Interactive Program Guide.....	6
M-Card™.....	6
Connecting Your DCX Set-top	7
Cable-In Connection.....	7
Video Connection Options.....	8
HDMI or IEEE-1394 — HDTV and SDTV.....	8
Component Video (YPbPr) — HDTV and SDTV.....	8
Composite Video (also referred to as Video) — SDTV.....	8
Connecting an HDTV — Single Connection for Video/Audio.....	9
HDMI.....	9
IEEE-1394.....	9
Connecting an HDTV — Separate Video/Audio Connections.....	11
DVI.....	11
Component Video (YPbPr).....	11
Audio.....	11
Connecting an A/V Receiver — Audio.....	14
Connecting an SDTV.....	16
Connecting an SDTV and VCR/DVD Recorder.....	18
Connecting an A/V Receiver, SDTV, and VCR/DVD Recorder.....	20
Recording Your Connections	23
Data Devices.....	24
Data Features.....	24
On-Screen Graphics	25
Configuring the User Settings	26
Getting Started.....	26
Configuring the DCX3200-M Settings on the User Settings Menu Screen.....	26



Native Mode Settings Screen.....	31
Additional HDMI Settings Screen.....	35
Additional Closed Caption Settings Screen	38
Subtitle and DVS Settings Screen	40
Advanced Audio/Video Settings Screen	42
Troubleshooting	44

Tables

Table 1: Front Panel Features.....	4
Table 2: Rear Panel Features.....	5
Table 3: User Settings Menu Field Descriptions	29
Table 4: Native Mode Settings Field Definitions	33
Table 5: Additional HDMI Settings Field Definitions	36
Table 6: Additional Closed Caption Settings Field Definitions.....	39
Table 7: Subtitle and DVS Settings Field Definitions.....	41
Table 8: Advanced Audio/Video Settings Field Definitions.....	43

Figures

Figure 1: Front Panel	4
Figure 2: Rear Panel	5
Figure 3: Connecting an HDTV — Single Connection for Video/Audio.....	10
Figure 4: Connecting an HDTV — Separate Video/Audio Connections.....	12
Figure 5: Connecting to an HDTV — Alternate Audio Connections	13
Figure 6: Connecting an A/V Receiver — Audio	15
Figure 7: Connecting an SDTV.....	17
Figure 8: Connecting an SDTV and VCR/DVD Recorder.....	19
Figure 9: Connecting an A/V Receiver, SDTV, and VCR/DVD Recorder.....	21
Figure 10: Data Device connections.....	24
Figure 11: User Settings Menu—No HDMI Connection	27
Figure 12: Default User Settings Menu When an HDMI Connection is in Place	27
Figure 13: User Settings Menu—Available Options Illustrated.....	28
Figure 14: Native Mode Settings menu screen.....	32
Figure 15: Additional HDMI Settings screen	35
Figure 16: Additional Closed Caption Settings menu screen	38
Figure 17: Subtitle and DVS Settings Menu Screen.....	40
Figure 18: Advanced Audio/Video Settings Menu Screen.....	42



Introduction

Congratulations on receiving a Motorola DCX3200-M High-Definition All-Digital Cable Set-top box, one of the most advanced interactive digital cable set-tops available today. Motorola has merged the extraordinary features of digital cable — the seemingly endless programming options, interactive program guides, Video on Demand (VOD), and the incredible picture quality and sound of High-Definition TV (HDTV).

This set-top includes an “Entertainment Package” that enables a direct digital connection to consumer audio and video devices through IEEE-1394 and HDMI™ interfaces. Dolby® Digital Plus is supported by the HDMI interface and provides 7.1 channels and beyond of enhanced-quality audio.

This User Guide introduces you to the basic features, outlines important safeguards, and provides several options for integrating this component into your current entertainment system. Please take a few moments to read through this User Guide; the configuration diagrams, on-screen menu description and troubleshooting section will help you make the most of your home entertainment experience.

To determine which features of digital cable are provided in your service area, please check with your local cable operator. They will be happy to provide instructions for these optional services.

Features

- Integrated MoCA™ networking
- HDMI, Component, IEEE-1394, Composite, Digital Audio (S/PDIF), Audio L/R, Ethernet, USB
- 1080p 24/30 video decode and 1080p60 output support



Front Panel

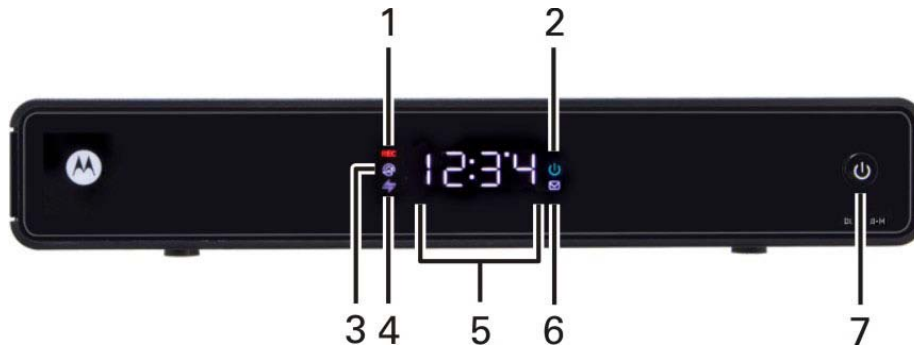

Figure 1: Front Panel

Table 1: Front Panel Features

1	Rec — Unit is in record mode on a home network device
2	Power LED— Illuminates when the DCX3200-M is powered on
3	Home LAN — Illuminates to indicate one or more set-top boxes and/or DVR devices are detected on the home network
4	Data — Dual function LED <ul style="list-style-type: none"> • Flashes to indicate unit is booting/provisioning • Extinguished when unit is provisioned
5	Front Panel Clock/Display — 4-character, 7 segment display
6	Message — Illuminates when the Interactive Program Guide has delivered a message to your set-top
7	Power Button — Turns the set-top on and off (standby)



Rear Panel

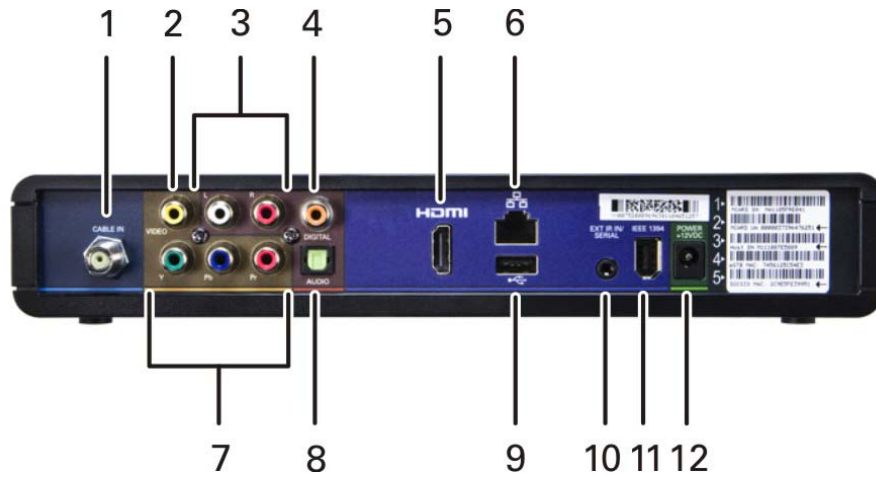

Figure 2: Rear Panel

Table 2: Rear Panel Features

1	Cable In — Connects to cable signal from the service provider
2	Video Out — Composite Video (SDTV)
3	Baseband Audio Out — L/R audio
4	Digital Audio (coaxial) — Provides Dolby® Digital 5.1 audio or PCM output
5	HDMI™ — High-Definition TV (HDTV) connector (Provides Dolby® Digital Plus (7.1) audio, Dolby® Digital 5.1 audio or PCM output)
6	Ethernet* — Network connection
7	Video outputs / YPbPr — Component Video output (HDTV)
8	Digital Audio (optical) — Provides Dolby® Digital 5.1 audio or PCM output
9	USB* 2.0 — High-speed peripheral device connection
10	Ext IR Input – Connects to a remote control receiver accessory cable
11	IEEE-1394 — Audio and video device connection
12	Power connector

* Availability of certain features is dependent upon application support.



2

Operation

Turning Power On and Off

Press power on the front panel or the remote control to turn the DCX set-top on or off (standby). Be sure the remote control is in cable mode by pressing cable before pressing power.

Changing Channels

You can change channels in three ways:

- Press channel + or – on the remote control to step through the channel selection.
- Enter the number of the channel you wish to view using the number keys on the remote control.
- Select the channel in the Interactive Program Guide.

Adjusting the Volume

Volume adjustment is available when using the Baseband Audio Outputs. Press volume + or – on the remote control to adjust the volume. When you adjust the volume, the volume scale is displayed on the screen. Press mute on the remote control to toggle the sound on and off.

For best audio quality when using the analog L/R audio outputs, use the remote control to set the DCX set-top to approximately three quarters of the maximum volume level and then adjust the audio levels on external devices such as your TV or A/V receiver.

Interactive Program Guide

The Interactive Program Guide displays information about TV programs and enables you to access features such as Parental Control or Pay-Per-View. Interactive program guides can vary with each cable service provider. Refer to the Interactive Program Guide's instruction manual for detailed instructions.

M-Card™

The M-Card is required to view cable television programs and interactive on-demand programs. The M-Card should not be removed.



3

Connecting Your DCX Set-top

Instructions and diagrams are included for the following connections:

- High-Definition TV (HDTV)
- A/V receiver — Audio
- Standard-Definition TV (SDTV)
- Standard-Definition TV (SDTV) and VCR/DVD Recorder
- A/V receiver, Standard-Definition TV (SDTV), and VCR/DVD Recorder

Before you move or change components on your entertainment system, review the following:

- For basic cable connections, use 75-ohm coaxial cables equipped with F-type connectors
- Disconnect power from your equipment before connecting or changing cable connections

CAUTION!

Do not place anything on top of your DCX set-top, especially other home entertainment components. Be sure to provide adequate ventilation to prevent overheating.

Cable-In Connection

The first step for all connection options is to connect an RF coaxial cable to the cable wall outlet and the cable in connector on the DCX set-top.



Video Connection Options

The DCX set-top offers several different video connection options. Component Video, HDMI, and IEEE-1394 allow you to view both High-Definition and Standard-Definition TV programming. Composite video connections allow you to view only Standard-Definition TV programming.

To determine whether your TV features component video, HDMI, IEEE-1394, or composite video, check the manual supplied with your TV.

Use the guidelines below to determine the best video connection for your home entertainment system.

Note: Only one video connection to the TV is required. HD video can only be viewed with HDMI, IEEE-1394, or component video connections.

HDMI or IEEE-1394 — HDTV and SDTV

- HDMI and IEEE-1394 offer higher quality HD video than component video.
- If your TV has an HDMI input, this is for both audio and video. Connect a standard HDMI cable to the TV and to the HDMI connector on your DCX set-top.
- HDMI and IEEE-1394 outputs provide video and audio, so no separate audio connections are required if you plan to use your TV's speakers as the primary audio source.
- On-screen graphics are not displayed when you use the IEEE-1394 connection on the rear panel of the DCX set-top. Refer to [On Screen Graphics](#) for more information.
- If your TV has a DVI input, connect a DVI-to-HDMI adapter or cable to the HDMI out connector on the DCX set-top and the DVI-HDTV connector on your TV.

Note: DVI does not provide audio. A separate audio connection must be made.

Note: Motorola recommends certified standard (category 1) HDMI cables for 1080i or 720p resolutions. A certified high speed (category 2) HDMI cable is recommended for resolutions of 1080p.

Component Video (YPbPr) — HDTV and SDTV

- The YPbPr connectors on your DCX set-top provide HDTV and SDTV component video.

Note: Component Video does not provide audio. A separate audio connection must be made.

Composite Video (also referred to as Video) — SDTV

- The Video out connector on your DCX set-top provides a composite video connection.

Note: Composite video does not provide audio. A separate audio connection must be made.



Connecting an HDTV — Single Connection for Video/Audio

HDMI

If your TV has an HDMI input, this is for both audio and video if you are using the TV speakers. Connect a standard HDMI cable to the TV and to the HDMI connector on your DCX set-top.

IEEE-1394

If your HDTV has an IEEE-1394 connector, you can use the IEEE-1394 for both your video and audio connection. Connect an IEEE-1394 cable to the IEEE-1394 connector on your HDTV and DCX set-top.

Note: On-screen graphics are not displayed when you use the IEEE-1394 connection on the rear panel of the DCX set-top. Refer to [On Screen Graphics](#) for more information.

If you have an audio/video receiver and are not using your TV's speakers, go to [Connecting an A/V Receiver — Audio](#).

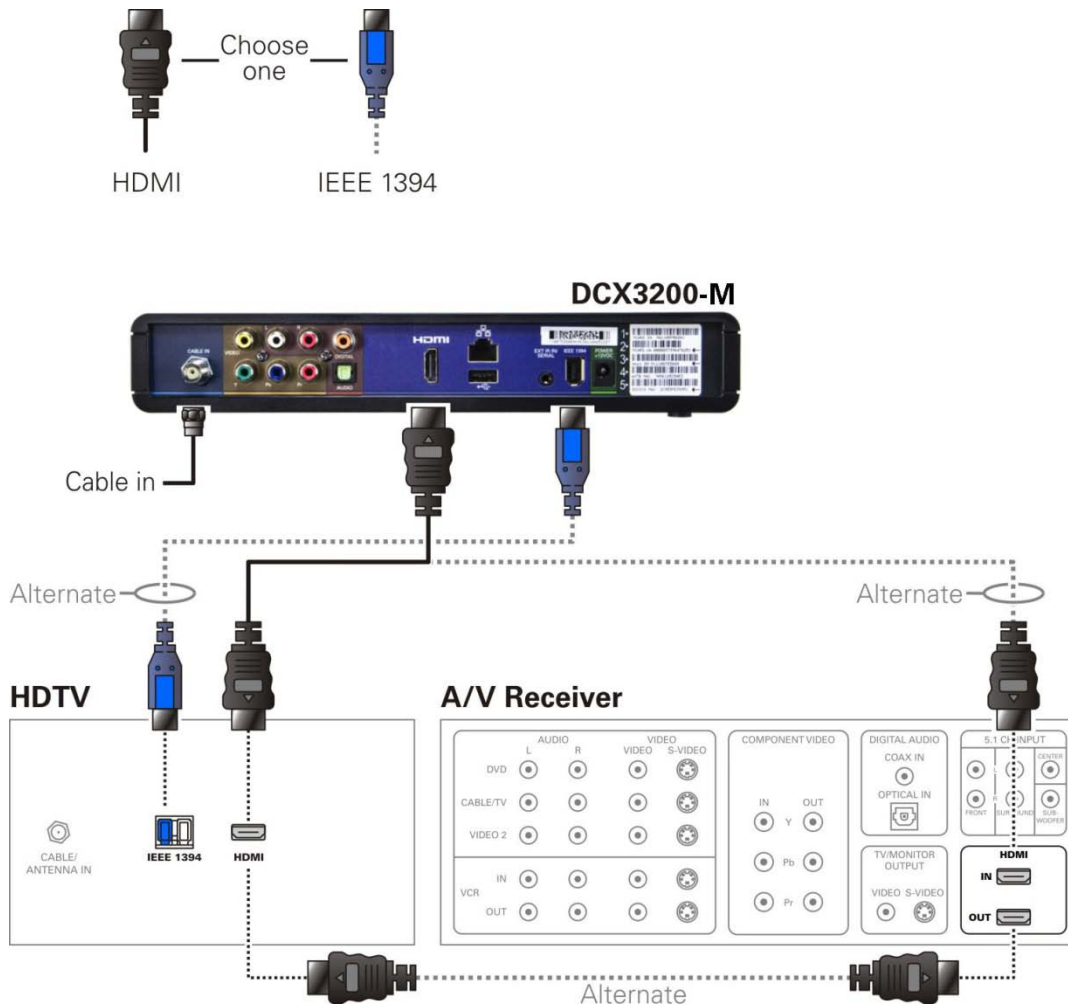

Figure 3: Connecting an HDTV — Single Connection for Video/Audio

Note: Only one HDTV video/audio connection needs to be made to an HDTV.

Note: On screen graphics are not displayed when you use an IEEE-1394 connection. Refer to [On Screen Graphics](#) for more information.

Note: Solid lines indicate optimum connections.

Note: Optional HDMI connection to A/V Receiver shown but not required.



Connecting an HDTV — Separate Video/Audio Connections

DVI

If your TV has a DVI input, use the DVI connection for your video. Connect a HDMI-to-DVI adapter or cable to the HDMI out connector on the DCX set-top and the DVI-HDTV connector on your TV.

Note: A DVI connection supports only the video connection between the DCX set-top and the HDTV. The DVI connection must be HDCP compatible.

To connect your audio connections with your TV speakers, see the [Audio](#) section.

To connect your audio connections for an A/V receiver, see [Connecting an A/V Receiver — Audio](#).

Component Video (YPbPr)

Connect the component video cables to the Y, Pb, and Pr connectors on your HDTV and DCX set-top.

Note: This connection only supports the video connection between the DCX set-top and the HDTV.

Note: Be sure to match up each signal to the same connection on the TV, otherwise the colors will not appear correctly on your TV.

To connect your audio connections with your TV speakers, see the [Audio](#) section.

To connect your audio connections for an A/V receiver, see [Connecting an A/V Receiver — Audio](#).

Audio

If your TV does not have digital audio inputs, connect the stereo audio cable to the audio L/R connectors on the DCX set-top and the audio L/R connectors on the HDTV.

If your TV supports digital audio inputs, use the digital audio optical S/PDIF or coaxial S/PDIF outputs instead of the audio L/R outputs. S/PDIF offers better audio quality, including support for Dolby® Digital audio.

For information on configuring your DCX set-top settings, see [Configuring the User Settings](#).

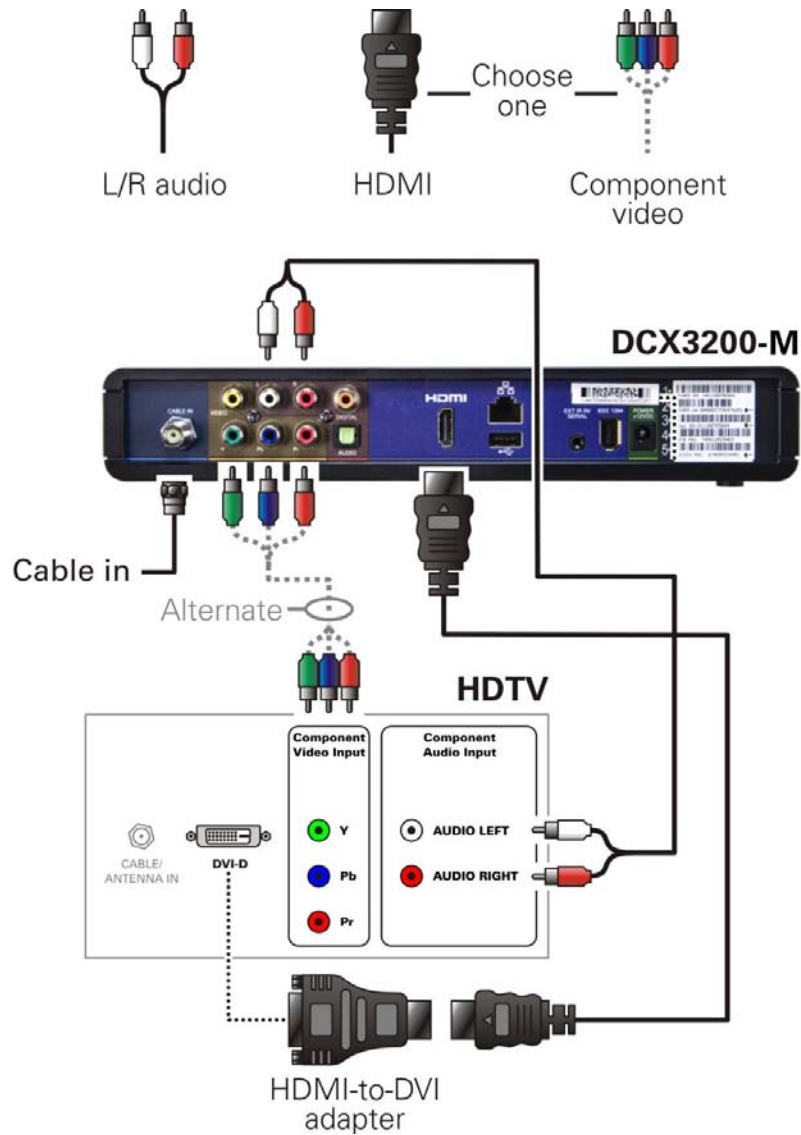

Figure 4: Connecting an HDTV – Separate Video/Audio Connections

Note: Only one video connection and one audio connection need to be made to an HDTV.

Note: Solid lines indicate optimum connections.

Note: HDMI-to-DVI adapter is not included with the set-top.

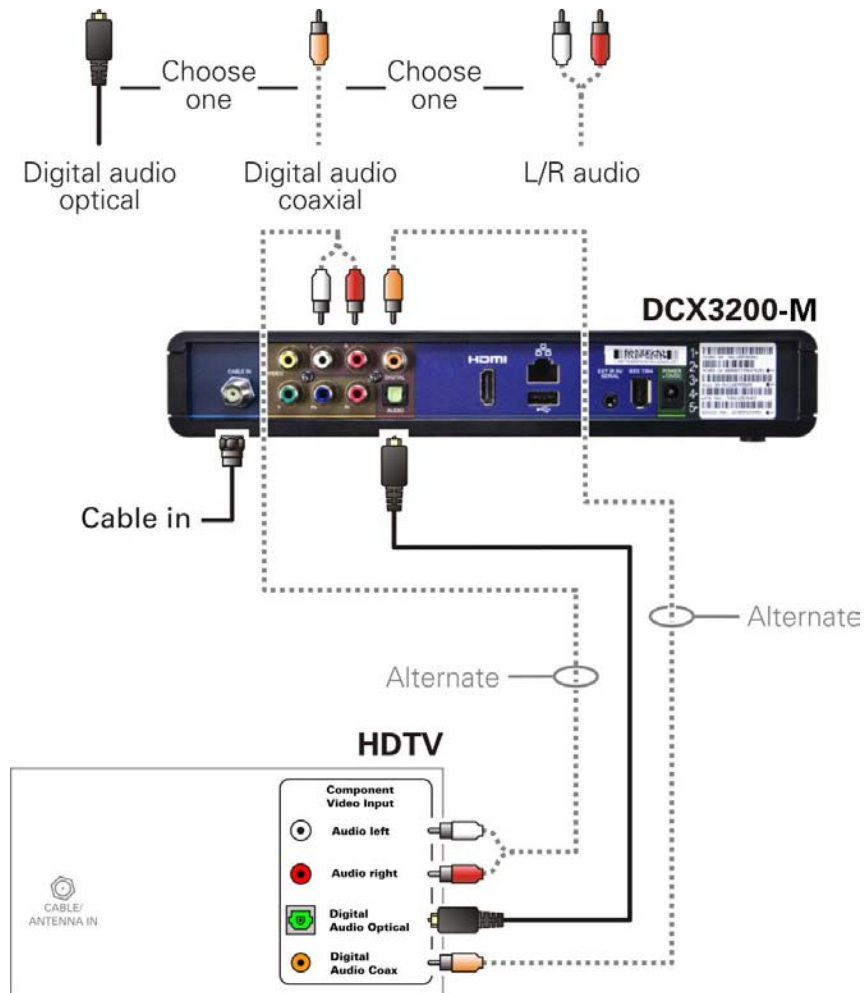

Figure 5: Connecting to an HDTV – Alternate Audio Connections

Note: Only one audio connection needs to be made.

Note: Solid lines indicate optimum connections.



Connecting an A/V Receiver — Audio

There are several options available for audio connections to your A/V receiver:

- Digital audio (OPTICAL S/PDIF)
- Digital audio (COAXIAL S/PDIF)
- Stereo audio (AUDIO L/R)

If your A/V receiver supports it, the optical (S/PDIF) or coaxial (S/PDIF) digital audio outputs may be used in place of the stereo audio outputs (audio L/R). These outputs offer a higher level of audio quality, including support for Dolby Digital audio.

- **Digital audio optical (S/PDIF)** — Connect an optical cable to the digital audio optical out connector on the DCX set-top and the digital audio optical in connector on the A/V receiver.
- **Digital audio coaxial (S/PDIF)** — Connect a digital audio cable to the digital audio coaxial out connector on the DCX set-top and the digital audio coaxial input connector on the A/V receiver.
- **Stereo audio** — Connect a stereo audio cable to the audio L/R output connectors on the DCX set-top and the audio L/R input connectors on the A/V receiver.

For information on configuring your DCX set-top settings, see [Configuring the User Settings](#).

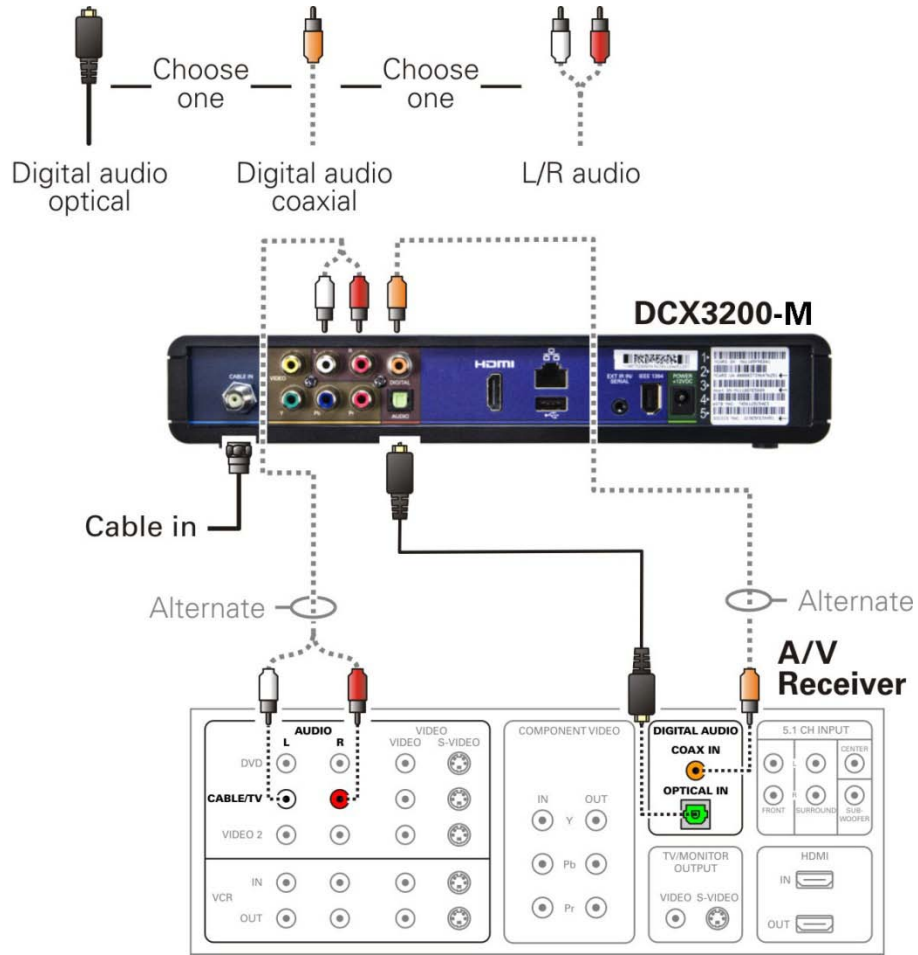

Figure 6: Connecting an A/V Receiver – Audio

Note: Only one audio connection needs to be made to an A/V Receiver.

Note: Solid lines indicate optimum connections.



Connecting an SDTV

1. Connect a stereo audio cable to the audio L/R output connectors on the DCX set-top and the audio L/R input connectors on the Standard-Definition TV (SDTV).
2. Connect a composite video cable to the composite video output connector on the DCX set-top and the composite video input connector on the TV.

These video connection methods do not support HD video. If you have an HDTV, see [Connecting an HDTV — Single Connection for Video/Audio](#).

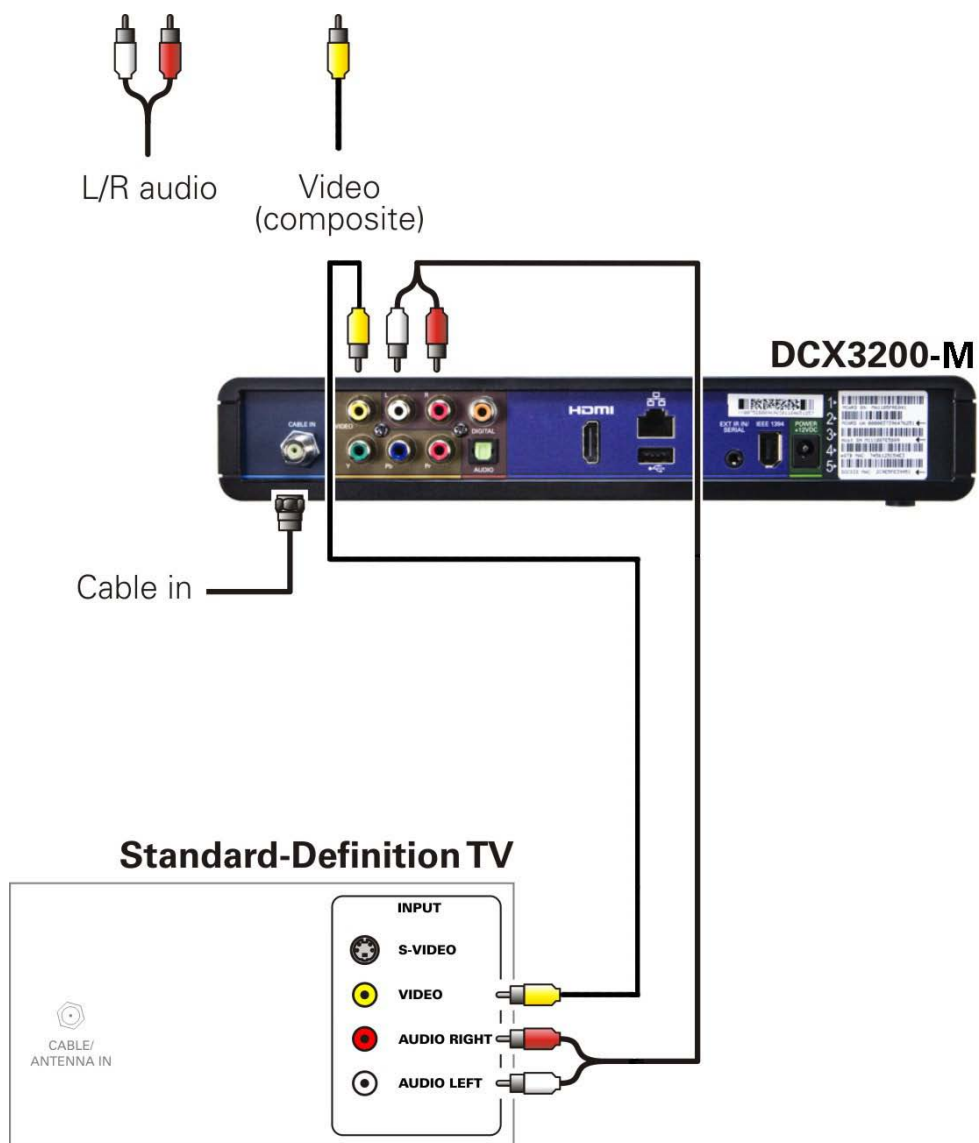

Figure 7: Connecting an SDTV

Note: Composite video requires separate audio connections.

Note: Only one video connection and one audio connection is required.



Connecting an SDTV and VCR/DVD Recorder

1. Connect a stereo audio cable to the audio L/R output connectors on the DCX set-top and the audio L/R input connectors on the VCR/DVD recorder.
2. Connect a composite video cable to the composite video out connector on the DCX set-top and the composite video input connector on the VCR/DVD recorder.
3. Connect a stereo audio cable to the audio L/R output connectors on the VCR/DVD recorder and the audio L/R input connectors on the Standard-Definition TV (SDTV).
4. Connect a composite video cable to the composite video output connector on the VCR/DVD recorder and the composite video input connector on the Standard-Definition TV (SDTV).

Note: You can also connect the TV to the VCR/DVD using the S-Video connectors if supported by your VCR/DVD recorder and SDTV.

These video connection methods do not support HD video. If you have an HDTV, see [Connecting an HDTV — Single Connection for Video/Audio](#).

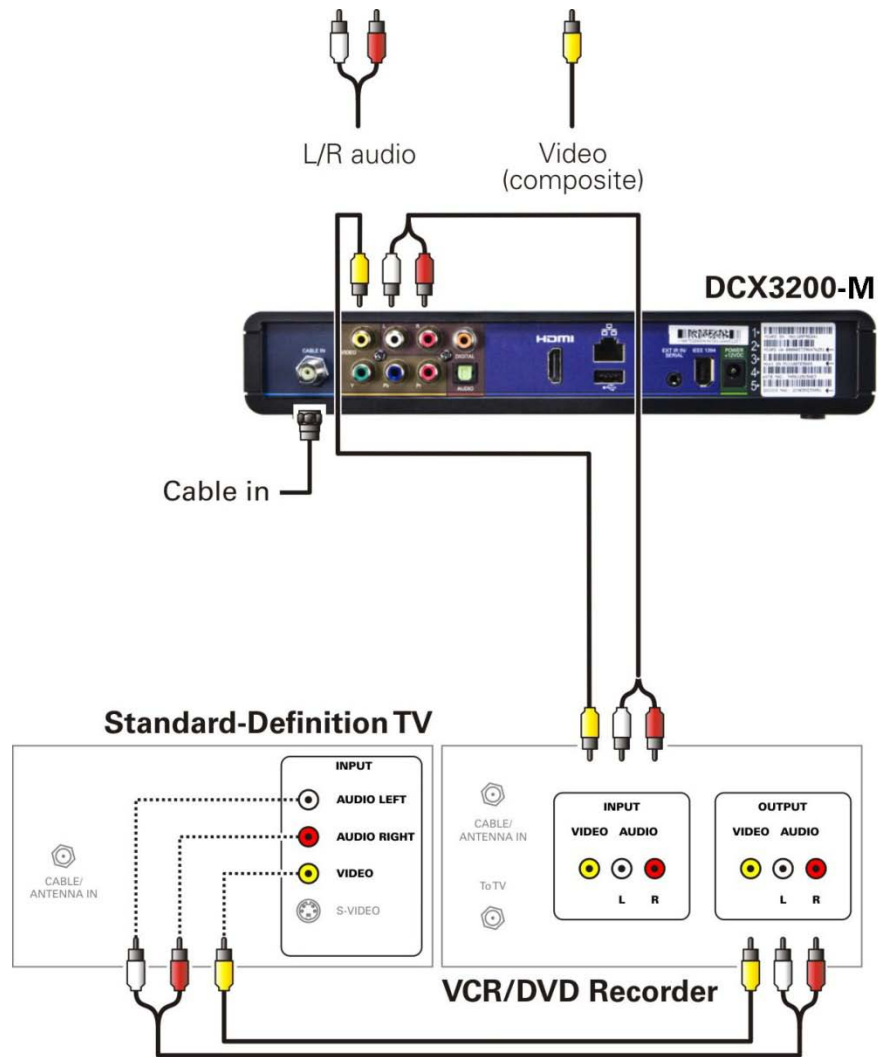

Figure 8: Connecting an SDTV and VCR/DVD Recorder



Connecting an A/V Receiver, SDTV, and VCR/DVD Recorder

1. Connect a stereo audio cable to the audio L/R output connectors on the DCX set-top and the audio L/R input connectors on the A/V receiver.
2. Connect a composite video cable to the composite video output connector on the DCX set-top and the composite video input connector on the A/V receiver.
3. Connect a stereo audio cable to the VCR/DVD recorder audio L/R output connectors on the A/V receiver and the audio L/R input connectors on the VCR/DVD recorder.
4. Connect a stereo audio cable to the audio L/R output connectors on the VCR/DVD recorder and the VCR audio L/R input connectors on the A/V receiver.
5. Connect a composite video cable to the composite video input connector on the VCR/DVD recorder and the composite video VCR output connector on the A/V receiver.
6. Connect a composite video cable to the composite video output connector on the VCR/DVD recorder and the composite video VCR input connector on the A/V receiver.
7. Connect a composite video cable to the composite video input connector on the Standard-Definition TV (SDTV) and the TV/monitor composite video output connector on the A/V receiver.

Note: The digital optical audio (optical S/PDIF) or digital coaxial audio (COAXIAL S/PDIF) outputs may be used in place of the stereo audio outputs (audio L/R). These outputs offer a higher level of audio quality, including support for Dolby Digital audio.

These video connection methods do not support HD video. If you have an HDTV, see [Connecting an HDTV — Single Connection for Video/Audio](#).

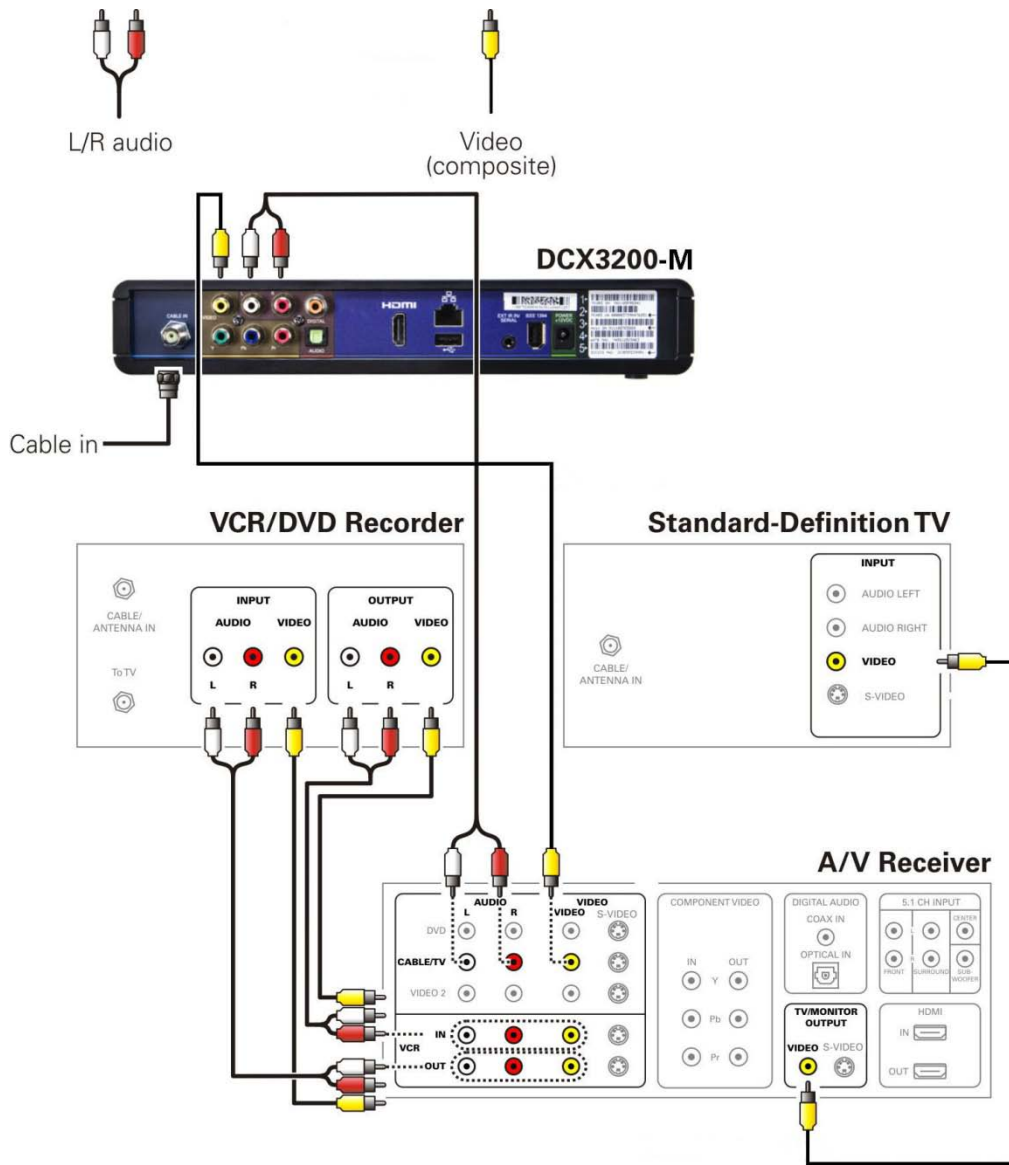

Figure 9: Connecting an A/V Receiver, SDTV, and VCR/DVD Recorder

Note: Solid lines indicate optimum connections.

Note: Consult your A/V receiver manual for additional wiring options or constraints when including a VCR/DVD recorder in your configuration.





4

Recording Your Connections

Use this diagram to record connections between your home entertainment components. You can use this diagram to reconnect your system if you move the equipment or add new equipment.

Disconnect the power from the DCX set-top before connecting or changing cable connections. Do not place another component or object on top of the DCX set-top.

DCX3200-M



VCR

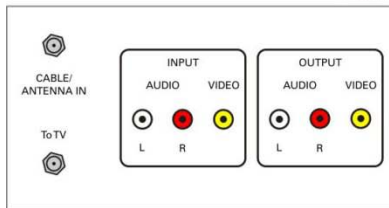

HDTV / Standard-Definition TV

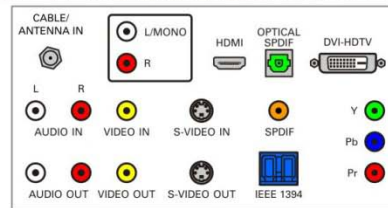

Audio receiver

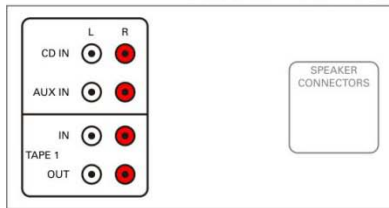

DVD

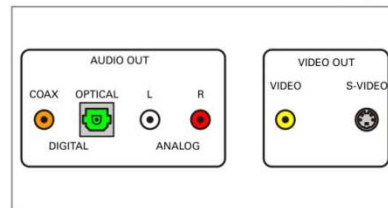

A/V receiver

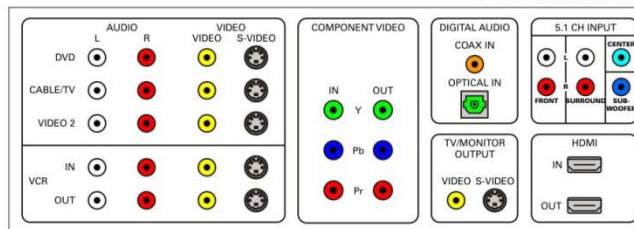



Data Devices

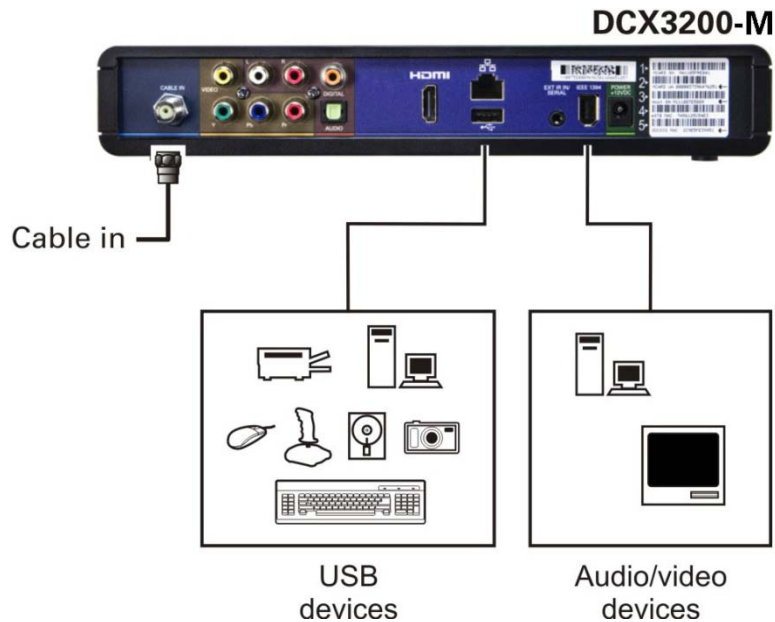

Figure 10: Data Device connections

Note: Do not attempt to connect data devices without contacting your service provider. Advanced data features require the proper application and network infrastructure to operate.

Data Features

In addition to high-quality audio and video, the DCX set-top has the capability to deliver high-speed data services such as Internet access, e-mail, IP telephony, e-commerce, and home banking.

Note: Your DCX set-top may be equipped with the interface connections illustrated, but their functionality depends on the services offered by your service provider.

**5**

On-Screen Graphics

Your DCX set-top can generate graphics that overlay the video programming or fill the entire television screen. Common examples include on-screen menus (such as the User Setting menu), closed captions, and interactive program guides. The DCX set-top overlays these graphics whenever you open a menu, enable closed captions, or scroll through a program grid.

- On-screen graphics are not available on all video output combinations.
- On-screen graphics are not displayed when you use the IEEE-1394 connection on the rear panel of the DCX set-top.



6

Configuring the User Settings

Getting Started

The following describes how to configure the audio (for HDMI connections), SD and HD video settings, and closed caption settings for the DCX3200-M.

Before you adjust the output settings:

1. Connect the DCX3200-M to the TV and other home entertainment devices.
2. Plug the DCX3200-M into an AC power outlet.
3. Initialize the DCX3200-M and authorize it for services.
4. Turn the TV on.

When using an HDMI connection between the DCX3200-M and the television, be sure to have the cable connected and the TV powered on before adjusting the video settings. Motorola recommends certified standard (category 1) HDMI cables for 1080i or 720p resolutions. A certified high speed (category 2) HDMI cable is recommended for resolutions of 1080p.

Configuring the DCX3200-M Settings on the User Settings Menu Screen

To configure the DCX3200-M settings on the User Settings menu screen, power off the DCX set-top and then press the menu key on the remote control. If your TV is on, the on-screen User Settings menu lists the DCX3200-M settings that can be adjusted.

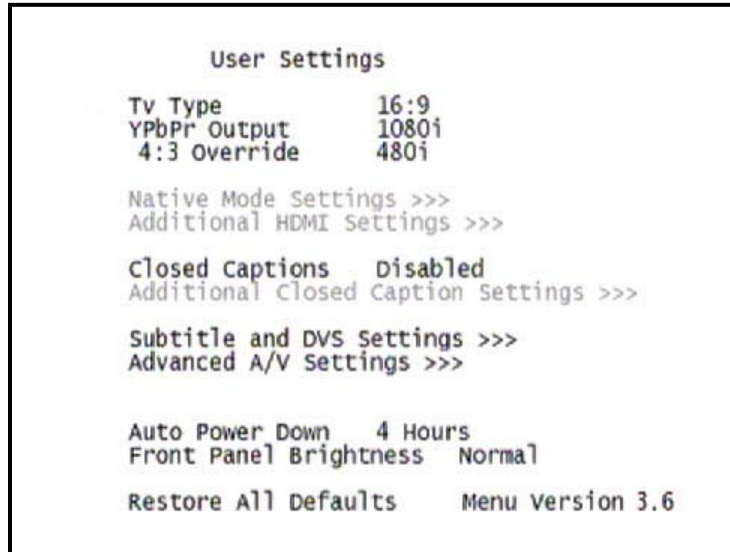

Figure 11: User Settings Menu—No HDMI Connection

If the DCX3200-M is connected via HDMI to a display device such as a television, the default User Settings menu is updated to reflect this information. The YPbPr Output menu option is replaced with the HDMI/YPbPr Output menu option as shown in the following example.

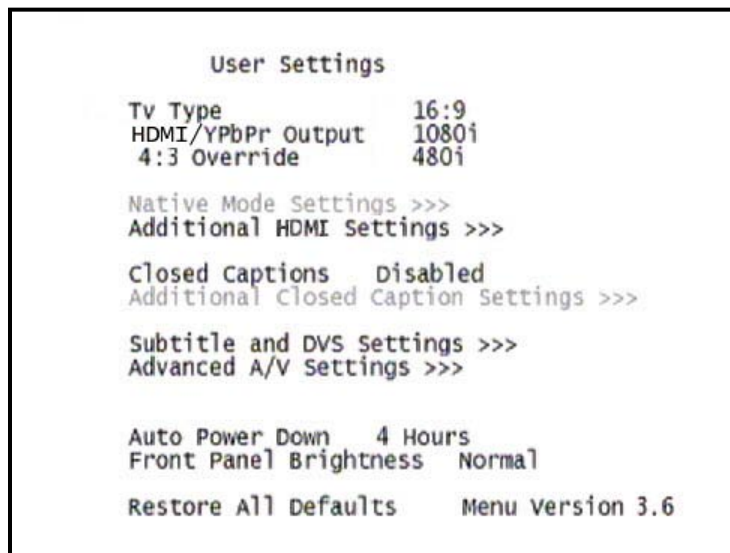

Figure 12: Default User Settings Menu When an HDMI Connection is in Place



Use your remote control to navigate the on-screen display:

- Press the ▲ and ▼ keys to highlight the setting you wish to change.
- Press the ► key to select an option for that setting.
- To exit the setting and move to another setting, use the ▲ and ▼ keys.
- To exit the menu and save your settings, press the power or menu key.

If the User Settings menu does not display on the HDTV Screen, the TV may not support the default video output settings. Connect the set-top to a Standard-Definition connection in order to view the menu. See the [Troubleshooting](#) section for more information.

The User Settings menu options available from the main screen are illustrated and defined below.

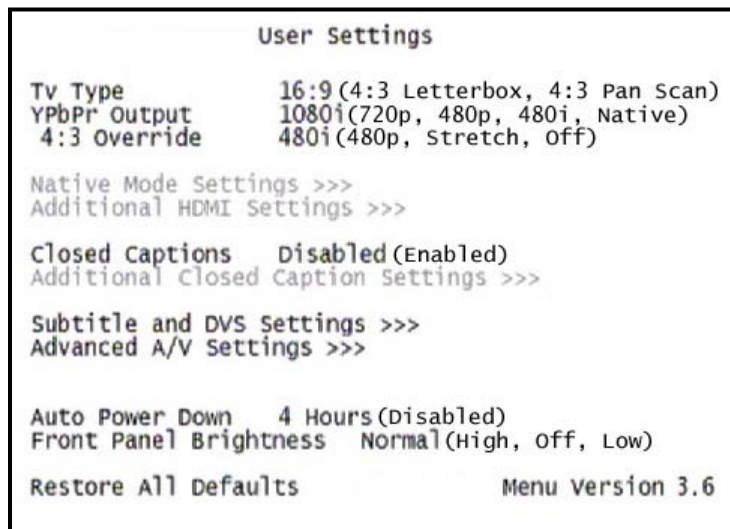

Figure 13: User Settings Menu—Available Options Illustrated

**Table 3: User Settings Menu Field Descriptions**

Setting	Description
TV Type	<p>Allows you to specify the style of television connected to the DCX3200-M. The 16:9 option is the default.</p> <ul style="list-style-type: none"> • 16:9— A widescreen television is connected to the DCX3200-M. • 4:3 Letterbox — A standard-screen television is connected to the DCX3200-M and widescreen programs should be scaled to fit the screen with black bars above and below the picture. • 4:3 Pan Scan—A standard-screen television is connected to the DCX3200-M and widescreen programs should be cropped so the picture fills the entire screen.
HDMI/YPbPr Output	<p>Allows you to select the video format of the HDMI and/or Component Video (YPbPr) outputs:</p> <ul style="list-style-type: none"> • For ALL programs when the 4:3 Override setting is set to either Off or Stretch. • For ONLY widescreen programs when the 4:3 Override is set to either 480i or 480p. <p>The 1080i option is the default.</p> <ul style="list-style-type: none"> • 1080p60—High-Definition 1080p60 format (1920 x 1080 pixels with progressive scanning at 60 frames per second). This is only available with HDMI. For component output, 1080p is down-converted to 480i. • 1080i—High-Definition 1080i format (1920 x 1080 pixels with interlaced scanning at 30 frames per second). • 720p—High-Definition 720p format (1280 x 720 pixels with progressive scanning at 60 frames per second). • 480p—Enhanced-Definition 480p format (720 x 480 pixels with progressive scanning at 60 frames per second). • 480i—Standard-Definition 480i format (720 x 480 pixels with interlaced scanning at 30 frames per second). • Native—Format that most closely matches the program’s native format according to the list of compatible formats selected from the Native Mode Settings menu screen. <p><i>Note : Not all televisions will support all available video formats. Consult the television’s user manual for more information on video format compatibility.</i></p> <p><i>The DCX3200-M can detect when the HDMI connection is in use. If you are not using the HDMI connection on the DCX3200-M, the HDMI/YPbPr Output setting will display as YPbPr Output in the User Settings Menu.</i></p> <p><i>Most new HDTVs are equipped with at least one HDMI input and can support the 1080p60 format. The DCX3200-M is designed to provide excellent video quality when converting any program to the 1080p60 video format. If your television supports 1080p60 video input, it is highly recommended to adjust the HDMI/YPbPr Output setting to the 1080p60 setting.</i></p>



Setting	Description
4:3 Override	<p>Allows you to select the video output format of the DCX3200-M when it is tuned to a Standard-Definition program or playing back a Standard- Definition program from the DVR. The 480i option is the default.</p> <ul style="list-style-type: none"> • 480i—Standard-Definition 480i format (720 x 480 pixels). • 480p—Enhanced-Definition 480p format (720 x 480 pixels). • Stretch—Automatically stretch all Standard-Definition programs to a widescreen (16:9) aspect ratio and present the video in the format designated by the HDMI/YPbPr Output setting. Note that the Stretch option is only available when the TV Type setting is 16:9. • Off—Widescreen version of a Standard-Definition program with black bars to the left and the right of the picture (pillarbox) and the video presented in the format designated by the HDMI/YPbPr Output setting. <p><i>Note: Not all televisions support all available video formats. Consult your television's user manual for more information on format compatibility.</i></p> <p><i>If the HDMI/YPbPr Output setting is set to either 480i or Native, the 4:3 Override feature is disabled and can't be selected in the menu. The 4:3 Override feature is available when the HDMI/YPbPr Output setting is 1080i, 720p, or 480p.</i></p>
Native Mode Settings	<p>Allows you to customize the Native Mode feature of the DCX3200-M by selecting the video formats supported by your television.</p> <p>Selecting the Native Mode Settings option presents a new menu screen with settings specific to Native Mode operation. These settings are discussed in more detail below.</p> <p>The Native Mode Settings option is only available when the HDMI/YPbPr Output setting is set to Native. Otherwise, the Native Mode Settings option is disabled and can't be selected in the menu.</p>
Additional HDMI Settings	<p>Available whenever an HDMI device is connected to the DCX3200-M. Selecting this option presents a new menu screen with settings specific to the HDMI connection. These settings are discussed in more detail later in the manual.</p> <p>If no HDMI device is connected to the DCX3200-M, this option is disabled and can't be selected in the menu.</p>
Closed Captions	<p>Turns closed captions off or on.</p> <p>When this option is set to Disabled, the DCX3200-M does not render (draw) closed captions on any video output.</p> <p>When this option is set to Enabled, the DCX3200-M renders (draws) closed captions on all video outputs if closed captions are included in the program.</p> <p>Disabled is the default setting.</p>
Additional Closed Caption Settings	<p>Allows you to customize the style and appearance of closed captions.</p> <p>Selecting this presents a new menu screen with settings specific to closed captions, including font style, color, and size. These settings are discussed in more detail below.</p> <p>The Additional Closed Caption Settings option is only available when the Closed Captions setting is set to Enabled. Otherwise, the Additional Closed Caption Settings option is disabled and can't be selected in the menu.</p>
Subtitle and DVS Settings	<p>Allows you to customize the operation of the subtitle and descriptive video service features.</p> <p>Selecting the Subtitle and DVS Settings option presents a new menu screen with settings</p>



Setting	Description
	specific to subtitle and descriptive video service operation. These settings are discussed in more detail below.
Advanced Audio/Video Settings	Allows you to customize several advanced audio and video features of the DCX3200-M.
Auto Power Down	Allows you to select whether the set-top turns itself off after four hours. <ul style="list-style-type: none"> • 4 Hours—The set-top powers down after four hours. • Off—The set-top does not power down by itself.
Front Panel Brightness	Allows you to adjust the brightness level of the front panel display (clock/channel number and indicator icons) of the DCX3200-M. <ul style="list-style-type: none"> • High—The brightest level. This setting is most useful when using the DCX3200-M in very brightly lit rooms. • Normal—The default brightness level. • Low—The lowest (visible) brightness level. This setting is most useful when using the DCX3200-M in dim or dark rooms. • Off—The front panel display will be turned off completely, including the clock/channel number and all indicator icons. If the set-top is equipped with a backlit power button, the blue backlighting remains illuminated.
Restore All Defaults	To reset ALL of the DCX3200-M User Settings to their default values, including options stored on other menu screens, move the cursor to this option and press the ► key.

Native Mode Settings Screen

The Native Mode Settings menu is used to configure the operation of the native mode feature on the DCX3200-M. The DCX3200-M is capable of receiving and decoding a number of different digital video formats. When operating in native mode, the DCX3200-M generates a video output format that most closely matches the broadcast video format.

For example, if the DCX3200-M is configured to operate in native mode, a channel broadcast in the 720p format will be output to the television in the 720p format, while a channel broadcast in the 1080i format will be output to the television in the 1080i format.

When using the native mode feature of the DCX3200-M, please exercise caution when selecting the formats from the checklist. If a format is selected that is not compatible with the television, there may be a loss of video whenever the DCX3200-M is tuned to a channel which is broadcast in that format.

If the television is connected to the DCX3200-M using an HDMI cable, the DCX3200-M will automatically customize the checklist of supported formats as reported to it by the television. If the television is connected to the DCX3200-M using Component Video (YPbPr) cables, the checklist will need to be customized manually. *Note that at least one*



of the [1080p - 1080i - 720p - 480p - 480i] formats must be selected from the checklist for the DCX3200-M to operate properly in native mode.

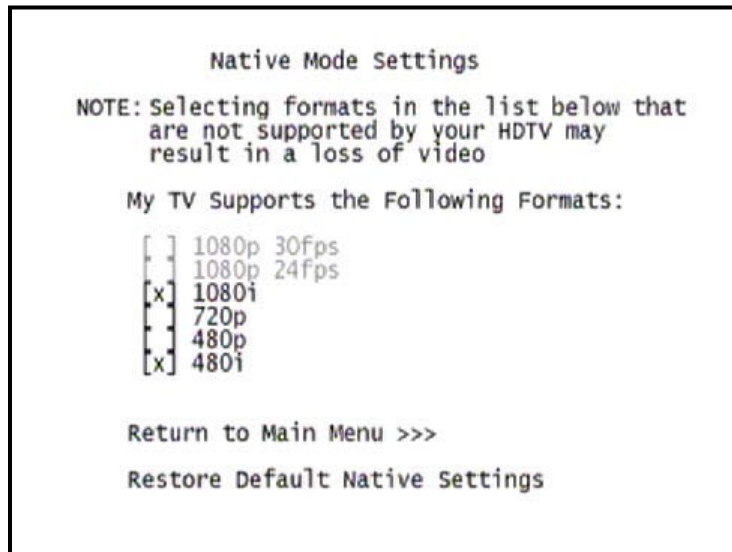

Figure 14: Native Mode Settings menu screen

**Table 4: Native Mode Settings Field Definitions**

Setting	Description
1080p30 (High Definition)	<p>Generates 1080p30 video on the HDMI output if the program is broadcast in 1080p30 format. The DCX3200-M cannot convert any other broadcast format to the 1080p30 video format.</p> <p>1080p30 is a high-definition video image with 1920 x 1080 pixels, progressive scanning, and a frame rate of 30 frames per second.</p> <p>This option is only available if the DCX3200-M is connected to an HDMI display device. If no HDMI connection is detected, this option is disabled and can't be selected in the menu.</p> <p><i>Note: The Component Video (YPbPr) output delivers 480i video whenever the HDMI output is delivering 1080p30 video.</i></p>
1080p24 (High Definition)	<p>Generates 1080p24 video on the HDMI output if the program is broadcast in 1080p24 format. The DCX3200-M cannot convert any other broadcast format to the 1080p24 video format.</p> <p>1080p24 is a high-definition video image with 1920 x 1080 pixels, progressive scanning, and a frame rate of 24 frames per second.</p> <p>This option is only available if the DCX3200-M is connected to an HDMI display device. If no HDMI connection is detected, this option is disabled and can't be selected in the menu.</p> <p><i>Note: The Component Video (YPbPr) output delivers 480i video whenever the HDMI output is delivering 1080p24 video.</i></p>
1080i (High Definition)	<p>Generates 1080i video on both the HDMI and Component Video (YPbPr) outputs if the program is broadcast in 1080i format. The DCX3200-M can also convert any other broadcast format to the 1080i video format.</p> <p>1080i is a high-definition video image with 1920 x 1080 pixels, interlaced scanning, and a frame rate of 30 frames per second.</p>
720p (High Definition)	<p>Generates 720p video on both the HDMI and Component Video (YPbPr) outputs if the program is broadcast in 720p format. The DCX3200-M can also convert any other broadcast format to the 720p video format.</p> <p>720p is a high-definition video image with 1280 x 720 pixels, progressive scanning, and a frame rate of 60 frames per second.</p>
480p (Enhanced Definition)	<p>Generates 480p video on both the HDMI and Component Video (YPbPr) outputs if the program is broadcast in 480p format. The DCX3200-M can also convert any other broadcast format to the 480p video format.</p> <p>480p is an enhanced-definition video image with 720 x 480 pixels, progressive scanning, and a frame rate of 60 frames per second.</p>
480i (Standard Definition)	<p>If this option is selected, the DCX3200-M generates 480i video on both the HDMI and Component Video (YPbPr) outputs if the program is broadcast in 480i format. The DCX3200-M can also convert any other broadcast format to the 480i video format.</p> <p>480i is a standard-definition video image with 720 x 480 pixels, interlaced scanning, and a frame rate of 30 frames per second.</p>



Setting	Description
Restore Default Native Settings	<p>Selecting this option will restore the checklist of video formats to its default configuration. Use this option if audio and/or video has been lost after adjusting these settings from their default values.</p> <p>If you are the HDMI connection to your television, the checklist will be automatically customized according to the supported formats reported by the television.</p> <p>If you are using the Component Video (YPbPr) connection to your television, the checklist will have only the 1080i and 480i formats selected.</p>
Return to Main Menu	Selecting this option will return you to the User Settings Menu main screen.



Additional HDMI Settings Screen

The Additional HDMI Settings menu is used to configure advanced options that affect the operation of the DCX3200-M with other HDMI and DVI display devices. Adjustable options include display mode, color space, audio output mode, and audio lip sync delay.

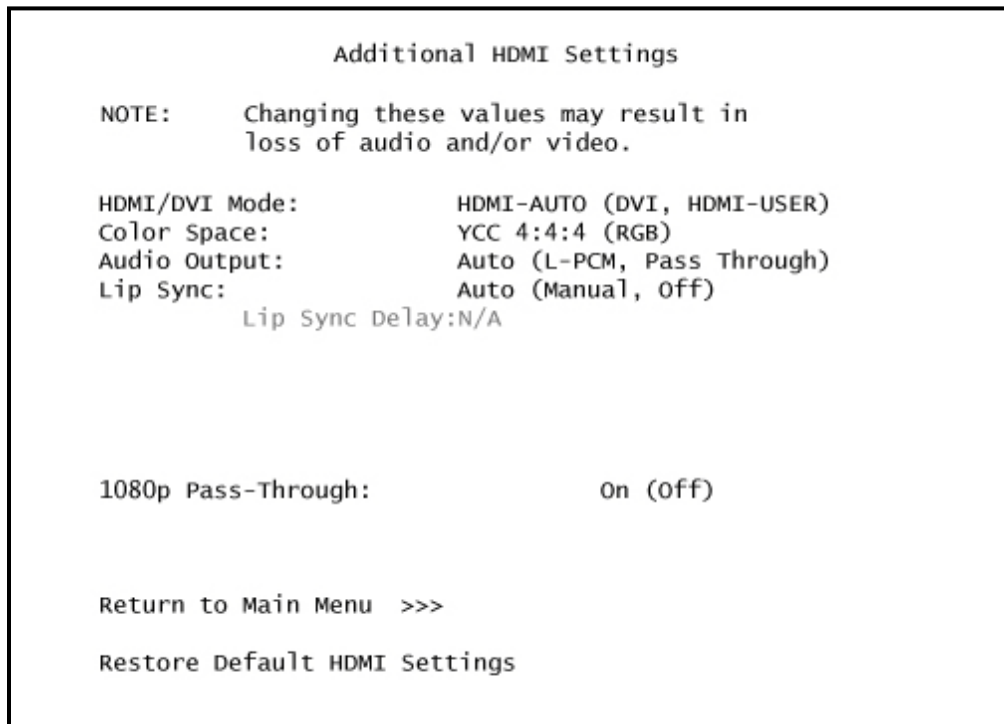

Figure 15: Additional HDMI Settings screen

**Table 5: Additional HDMI Settings Field Definitions**

Setting	Description
HDMI/DVI Mode	<p>Allows you to optimize the HDMI output to work with both DVI-equipped televisions and HDMI-equipped televisions. HDMI is the default setting.</p> <ul style="list-style-type: none"> • HDMI—Optimized to work with an HDMI television or home theater receiver. • DVI—Optimized to work with a DVI television or display device (connected via an HDMI-to-DVI adapter).
Color Space	<p>Allows you to adjust the color space used by the DCX3200-M to generate the video signals on the HDMI output. YCC 4:4:4 is the default setting.</p> <ul style="list-style-type: none"> • YCC 4:4:4—Generates video signals within the YCC color space. • RGB—Generates video signals within the RGB color space. <p><i>Note: Adjusting these settings could result in a loss of video. Only a professional installer or someone with a good working knowledge of the color spaces supported by the TV should change this setting.</i></p>
Audio Output	<p>Allows you to specify the digital audio format delivered over the HDMI output by the DCX3200-M. Options include Auto, L-PCM, and Pass Through. Auto option is the default setting.</p> <ul style="list-style-type: none"> • Auto—Provides the digital audio format specified by the connected device (TV or home theater receiver) when that device was first connected to the DCX3200-M. • L-PCM—Provides all audio in the Linear Pulse Code Modulation digital audio format. The L-PCM format is widely supported by most HDMI televisions and home theater receivers. • Pass Through—Provides the same digital audio format on the HDMI output as is provided with the program being viewed at that time. For example, if the program has a Dolby Digital soundtrack, the DCX3200-M passes the Dolby Digital audio to the HDMI output. This option is most useful when connecting the DCX3200-M to a home theater receiver that has HDMI switching capability. <p><i>Note: Adjusting these settings could result in a loss of audio. Only a professional installer or someone with a good working knowledge of the digital audio formats supported by the TV and/or home theater receiver should change this setting.</i></p>
Lip Sync	<p>Allows you to adjust the amount of time the audio signal is delayed with respect to the video signal on the HDMI output. Some HDMI televisions and home theater receivers add an extra delay to the video signal during processing which can produce an effect where the audio noticeably “leads” the video.</p> <p>By default, this option is set to Auto. The options are used as follows:</p> <ul style="list-style-type: none"> • Auto—The DCX3200-M automatically delays the audio signal on the HDMI output by the amount of time requested by the connected HDMI device. • Manual—The DCX3200-M delays the audio signal on the HDMI output by the amount of time selected for the Lip Sync Delay setting. • Off—The DCX3200-M will not delay the audio signal on the HDMI output.



Setting	Description
Lip Sync Delay	<p>Available when the Lip Sync option has been set to Manual.</p> <p>The Lip Sync Delay setting can be adjusted between 0 milliseconds and 500 milliseconds in 50 millisecond increments.</p> <p>If the Lip Sync option has been set to either Auto or Off, this option is disabled and can't be selected in the menu.</p> <p>Use this option to adjust the HDMI audio delay if you notice that the video image routinely seems to be "behind" the audio soundtrack when using your HDMI device.</p>
1080p Pass-Through	<p>The set-top provides the same 1080p video format for the HDMI output as the video format provided with the program being viewed at that time.</p> <p>For example, if the program has a video format of 1920 x 1080 pixels with progressive scan at 24 or 30 frames per second, the DCX passes the same video format to the HDMI output without performing a format conversion. This option is most useful when connecting the DCX to a television that supports both 1080p24 and 1080p30 in order to force the best quality video signal to the TV with minimal configuration.</p> <p>Note: Not all televisions will support all available video formats. Consult the television's user manual for more information on video format compatibility.</p>
Return To Main Menu	Returns you to the User Settings Menu main screen.
Restore Default HDMI Settings	<p>Restores all of the settings on this screen (HDMI/DVI Mode, Color Space, Audio Output, and Lip Sync) to their default values.</p> <p>Use this option if you lose audio and/or video after changing these settings from their default values.</p>



Additional Closed Caption Settings Screen

The Additional Closed Caption Settings menu becomes available when Closed Captioning is enabled and is used to adjust the various display options for closed caption legibility. Customizable options include font size, font style, font color, and font opacity. You may also select to view different closed caption services if these are included within the broadcast program.

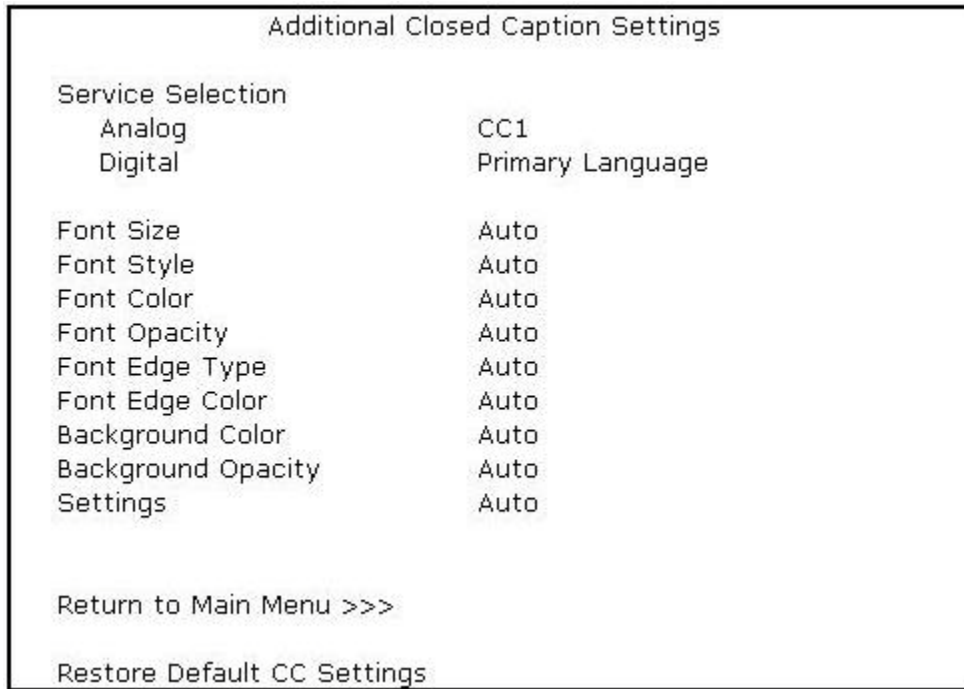

Figure 16: Additional Closed Caption Settings menu screen

**Table 6: Additional Closed Caption Settings Field Definitions**

Setting	Description
Service Selection	<p>Sets the service used by the DCX3200-M to render (draw) the closed captions:</p> <ul style="list-style-type: none"> • Analog—Affects closed captions for analog and digital standard definition services. Available options are: CC1, CC2, CC3, CC4, T1, T2, T3, or T4. The default setting is CC1. • Digital—Affects closed captions for digital enhanced definition and high definition services. Available options are: Primary Language, Secondary Language, 3, 4, 5, or 6. The default setting is Primary Language.
Font Size	Sets the font size used for rendering (drawing) closed captions. The default setting is Auto. Available options include: Auto, Standard, Large, or Small.
Font Style	Sets the font style used for rendering (drawing) closed captions. The default setting is Auto. Available options include: Auto, Mono Serif, Proportion Serif, Mono No Serif, Proportion No Serif, Casual, Cursive, or Small Capitals.
Font Color	Sets the font color used for rendering (drawing) closed captions. The default setting is Auto. Available options include: Auto, White, Black, Red, Green, Blue, Yellow, Magenta, or Cyan.
Font Opacity	Sets the opacity used for rendering (drawing) closed captions. The default setting is Auto. Available options include: Auto, Transparent, Translucent, Solid, or Flashing.
Font Edge Type	Sets the edge appearance used for rendering (drawing) closed captions. Available options include: Auto, None, Raised, Depressed, Uniform, Left Shadowed, or Right Shadowed. The default setting is Auto.
Font Edge Color	Sets the edge color used for rendering (drawing) closed captions. Available options include: Auto, White, Black, Red, Green, Blue, Yellow, Magenta, or Cyan. The default setting is Auto.
Background Color	Sets the background color used for rendering (drawing) closed captions. The default setting is Auto. Available options include: Auto, White, Black, Red, Green, Blue, Yellow, Magenta, or Cyan.
Background Opacity	Sets the background opacity used for rendering (drawing) closed captions. The default setting is Auto. Available options include: Auto, Transparent, Translucent, Solid, or Flashing.
Settings	Sets the default settings for closed captions (Auto) or restores the settings you had previously configured (User) allowing you to easily change the closed caption settings between their default settings and your customized settings. The default setting is Auto. Available options include: Auto or User.
Return To Main Menu	Returns you to the User Settings Menu main screen.
Restore Default CC Settings	To reset all of the Additional Closed Caption settings to their default values, navigate to this option and press the ► key.



Subtitle and DVS Settings Screen

The Subtitle and DVS Settings menu is used to customize the language and appearance of subtitles and to turn the descriptive video service feature on and off on the DCX3200-M. Subtitles allow a viewer to watch television programs and movies which contain dialogue that is not in the viewer's native language. Subtitles are not included within many television programs (unlike closed captions).

A descriptive video service (DVS) is a special secondary audio track which is included within many television programs and is intended to assist the visually impaired. The DVS audio track provides a verbal description of each scene along with the program's normal dialogue.

The Subtitle and DVS Settings menu screen is illustrated and defined below.



Figure 17: Subtitle and DVS Settings Menu Screen

**Table 7: Subtitle and DVS Settings Field Definitions**

Setting	Description
Subtitles	<p>The default setting is Off.</p> <ul style="list-style-type: none"> • Off—Subtitles are not rendered (drawn) by the DCX3200-M. • On—Subtitles are rendered (drawn) by the DCX3200-M if they are included in the program and in the language specified by the Language setting. <p>When the Subtitles option is set to On, Language can be selected from the menu.</p>
Language	<p>The Language setting is only available when the Subtitles option is set to On. Otherwise, this setting is disabled and can't be selected in the menu.</p> <p>The default language selection is English.</p> <ul style="list-style-type: none"> • English—Renders (draws) subtitles in English if they are included in the program. • Spanish—Renders (draws) subtitles in Spanish if they are included in the program. • French—Renders (draws) subtitles in French if they are included in the program. • Portuguese—Renders (draws) subtitles in Portuguese if they are included in the program. <p><i>Note: The DCX3200-M is not capable of translating subtitles from one language to another. For example, if French subtitles are included with the program, the DCX3200-M cannot translate them to into Portuguese if the Language option has been set to Portuguese. The DCX3200-M can only display subtitles in the language(s) that have been included within the program.</i></p>
Descriptive Video Service	<p>The default setting is Off.</p> <ul style="list-style-type: none"> • Off—The DVS audio track is not played by the DCX3200-M. • On—The DVS audio track is played by the DCX3200-M if it is included in the program. <p><i>Note: If the DVS setting is disabled and can't be selected from the menu, the software installed on the DCX3200-M can't support the DVS feature.</i></p>
Return To Main Menu	Returns you to the User Settings Menu main screen.
Restore Default Subt/DVS Settings	To reset all of the Subtitle and DVS settings to their default values, navigate to this option and press the ► key.



Advanced Audio/Video Settings Screen

The Advanced Audio/Video Settings menu is used to customize several advanced audio and video features of the DCX3200-M, most notably the Dolby Volume feature and the Video Sharpness feature.

The Dolby Volume feature provides volume normalization across channels, programs, and commercials. Normalization is a process where the different volume levels across channels, programs, and commercials are adjusted to the same approximate output volume. As a result, sudden volume changes are reduced and the overall volume output of the DCX3200-M is more consistent.

The Video Sharpness feature is used to soften or sharpen Standard Definition (SD) programs when viewed on either the HDMI or Component Video (YPbPr) outputs. When SD programs are viewed on a large screen television, picture quality can suffer because noise and other imperfections in the picture can be magnified on the large display. The Video Sharpness feature can be used to soften the picture and reduce the appearance of these imperfections.

The Advanced Audio/Video Settings menu screen is illustrated and defined below.

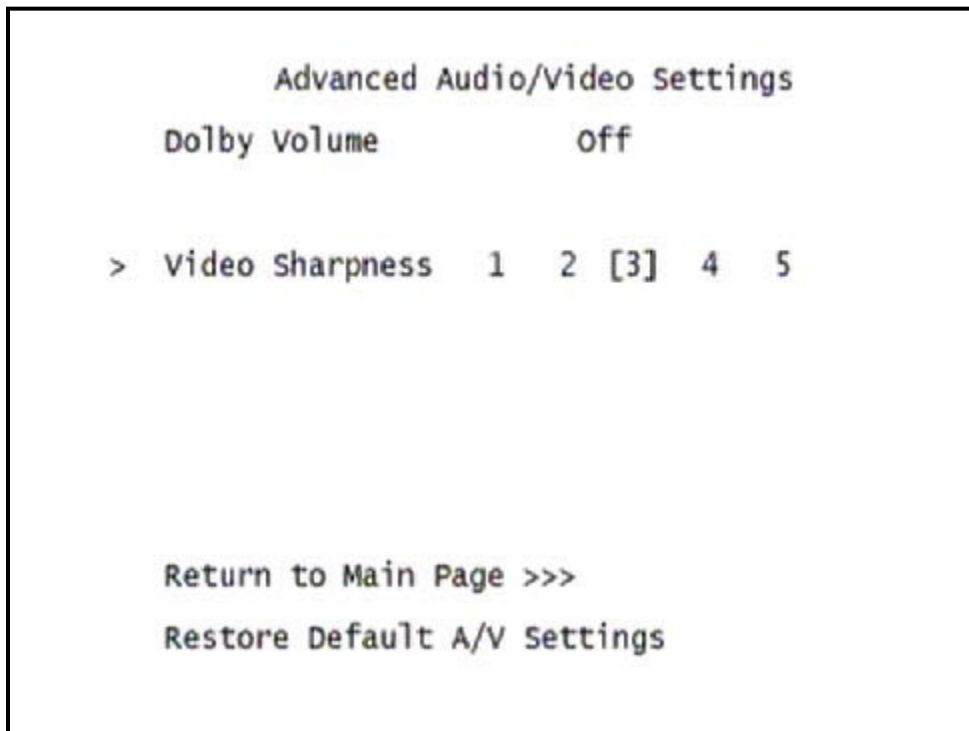

Figure 18: Advanced Audio/Video Settings Menu Screen

**Table 8: Advanced Audio/Video Settings Field Definitions**

Setting	Description
Dolby Volume	<p>The default setting is Off.</p> <ul style="list-style-type: none"> • Off—Output volume may fluctuate during commercials or when changing channels. • On—Maintains a more consistent output volume regardless of the channel or program being viewed.
Video Sharpness	<p>The Video Sharpness setting allows you to adjust the picture sharpness when viewing a standard definition (SD) program on the DCX3200-M.</p> <p>The Video Sharpness setting affects the HDMI and Component Video (YPbPr) outputs. Level 3 is the default value.</p> <p>The DCX3200-M supports five distinct levels of analog video picture sharpness. A value of 1 corresponds to a “softer” picture while a value of 5 corresponds to a “sharper” picture.</p> <p>The best sharpness setting depends upon the video connection being used, the display quality of the TV, and your own personal preference.</p>
Return To Main Menu	Returns you to the User Settings Menu main screen.
Restore Default A/V Settings	To reset all of the Advanced Audio/Video settings to their default values, navigate to this option and press the ► key.



7

Troubleshooting

Before calling your service provider, review this troubleshooting guide. This information is to help you quickly solve a problem. If your problem still exists, contact your service provider.

Problem	Possible Solution
<p>The DCX set-top will not power on</p>	<ul style="list-style-type: none"> • The DCX set-top has received a software update and may not power on while the new software is being installed. Try again in a few minutes. • Verify that the AC power cord of the external power supply is connected to the DCX set-top and an AC outlet. Unplug the DCX set-top from the AC outlet, plug it back in, and then press the POWER button. • If the DCX set-top is connected to a switched outlet on another unit, verify that that unit is powered on. Unplug the power cord from the DCX set-top's AC outlet, plug it back in, and then press the POWER button. Use an unswitched outlet, if possible. • Press the POWER button on the DCX set-top front panel instead of the remote control. The batteries in the remote control may be depleted.
<p>The remote control does not work</p>	<ul style="list-style-type: none"> • Verify that the remote control is in "Cable" mode. • Verify that there are no obstructions between the remote control and the DCX set-top. Aim the remote control directly at the DCX set-top front panel, not the TV or VCR. • The angle between the remote control and the DCX set-top may be too large. Stand in front of the DCX set-top and not too far to either side. • Press and release operation keys one at a time, firmly and deliberately. • Check the batteries in the remote control. Install new batteries if needed.
<p>The clock display appears blank</p>	<ul style="list-style-type: none"> • If the clock display is set to OFF, the setting is retained even if the box is power cycled off and on again. • Update the front panel display brightness setting in the User Settings Menu.
<p>There is no audio when viewing cable channels</p>	<ul style="list-style-type: none"> • Verify that the mute button on the remote control has not been pressed. Press mute on the remote control to restore sound. • If the DCX set-top audio output is connected to the TV, verify that the mute button on the TV has not been pressed. • If the DCX set-top audio output is connected to a home theater receiver, verify that the receiver is set to the appropriate input source and the mute button on the receiver has not been pressed. • Verify that you have the correct cables for the audio connections. • Verify that the audio cables are firmly connected between the DCX set-top and the audio playback device (TV, receiver, DVD player, etc.).



Problem	Possible Solution
<p>There is no audio from the center and/or surround speakers of a home theater receiver connected to the DCX set-top</p>	<p>Not all programs feature full Dolby Digital [5.1] or Dolby Digital Plus [7.1] surround sound. In some cases, the programs may only contain left and right stereo audio.</p> <ul style="list-style-type: none"> • Verify that the S/PDIF cable (optical) is firmly connected to the DCX set-top and the home theater receiver. • Verify that the home theater receiver is set to a surround sound audio mode (Dolby Pro Logic®, Dolby Pro Logic II®, Dolby Pro Logic IIx®). • Verify that the receiver is properly configured to work with all connected speakers.
<p>There is no video on the TV screen</p>	<ul style="list-style-type: none"> • Verify that the TV is powered on and set to the appropriate input source for the DCX set-top. • Verify that the DCX set-top is powered on and tuned to an authorized cable channel. • Verify that all video cables between the DCX set-top and the TV are firmly connected. • Verify that the coaxial cable feed is firmly connected to the DCX set-top and the wall jack. • If the DCX set-top video output is connected to a home theater unit, verify that the home theater unit is powered on and set to the appropriate input source. • If the DCX set-top video output is connected to a TV through an HDMI connection, power off the TV and then power off the DCX set-top. Wait one second and then power on the devices. • Not all HDTVs can display every output format (1080p60, 1080p30, 1080p24, 1080i, 720p, 480p, or 480i) available on the DCX set-top. To select a different format: <ol style="list-style-type: none"> 1. Ensure that your DCX set-top is plugged into a power outlet and is turned off. 2. Press the MENU key on the remote control. Your settings are displayed on the DCX set-top front panel display. 3. Press the ▲ and ▼ keys to display the HDMI/YPbPr OUTPUT setting. 4. Press the ► key to cycle through the available output formats until a picture displays on the TV.
<p>No graphics or program guides appear on the TV screen</p>	<p>If you use the IEEE-1394 connection, on-screen graphics, including closed captions and program guides, are not displayed by the DCX set-top. On-screen graphics and captions may still be overlaid by your TV, if enabled. Alternatively, use HDMI or component video instead.</p>
<p>No closed captions display</p>	<ul style="list-style-type: none"> • Verify on the User Settings menu that closed captions are enabled on the DCX set-top. • Verify that closed captions are enabled on the TV. <p><i>Note: Closed captioning may not be available on the current program.</i></p>



Problem	Possible Solution
<p>There are black bars to the right and left of the picture</p>	<p>Wide screen TVs display 4:3 programs in this format unless set to Stretch. Turn on the 4:3 OVERRIDE feature in the User Settings menu. This enables most wide screen TVs to stretch the video to fill the screen (see your TV manual for information about stretching 4:3 video).</p> <ul style="list-style-type: none"> • If the DCX set-top is connected to a wide screen TV, verify that the TV TYPE is set to 16:9 in the User Settings menu. <p>Many HD programs are broadcast in pillar-box format with black bars to the left and right of the picture. These programs are broadcast in 16:9 HD formats even though the video is not 16:9.</p>
<p>There are black bars above and below the picture</p>	<p>All 4:3 HDTVs display HD programs in letterbox format (black bars above and below the picture) because of the shape of the display screen.</p> <ul style="list-style-type: none"> • Turn on the 4:3 OVERRIDE feature in the User Settings menu. This enables most standard screen TVs to display a full screen picture when the DCX set-top is tuned to a 4:3 program. • Set the TV TYPE to 4:3 Pan-Scan. This enables the DCX set-top to remove the black bars above and below the picture when possible. <p>Some SD programs are broadcast in the letterbox format with black bars above and below the picture. Some widescreen TVs offer a zoom feature that may be able to remove the black bars (see your TV manual for information about zooming 4:3 video).</p>
<p>There are black bars on all four sides of the picture</p>	<p>This may occur on a 4:3 TV if the 4:3 OVERRIDE setting is OFF. To set 4:3 SD programming to fill the screen, depending on the capabilities of the TV, set 4:3 OVERRIDE to 480i or 480p.</p> <p>This may occur on a 16:9 TV if the active video for an SD broadcast is in letterbox format. To confirm, wait for a commercial or look for a graphic, such as a network logo. If the commercial fills the screen from top to bottom, or the graphic appears below the active video, the program is being letterboxed by the broadcaster. You can minimize this by activating the zoom feature on the TV.</p> <p>A broadcaster may include black bars on either side of a wide screen broadcast. This is called a "hybrid" aspect ratio and results in a black border surrounding the video on a 4:3 TV. Because this is part of the broadcast, the DCX set-top cannot correct the video. You may be able to minimize the border using the zoom feature on the TV.</p>
<p>Colors do not appear correctly</p>	<p>Be sure to match up each signal to the same YPbPr connection on the TV, otherwise the colors will not appear correctly on your TV.</p>



MOTOROLA

Motorola Mobility, Inc.
101 Tournament Drive, Horsham, PA 19044 www.motorola.com

365-095-17389 x.1 05/11

