

MLX Series Cylindrical Lever Locks

Professional Replacement Products



The MLX Series is a robust Grade 2 lockset featuring a FreeWheeling Lever for abuse resistance, two screw lockset install for quick installation and a 10 Year Mechanical Warranty. The perfect solution for replacing or upgrading locksets in commercial applications.

Features:

Door Preparation – Requires standard 2-1/8" (53.97mm) bore through door.

Backset – 2-3/4" (69.85mm)

Door Thickness – Fits 1-3/8" (34.93mm) to 1-3/4" (44.45mm) doors standard.

Latch – Stainless Steel 1/2" (12.7mm) throw, UL Listed, guarded latchbolt on all locking functions

Latch Front – 1-1/8" x 2-1/4" for 2-3/4" (69.85mm) backset.

Exposed Trim – MLX Levers are pressure cast zinc measuring 4-3/4" (120.65mm) in length. MLX Roses are wrought brass 3-11/32" (84.8mm) diameter. Total projection from face of door is 2-17/32" (64.5mm).

Finishes:

	BHMA	U.S. Equiv.	Arrow Equiv.	Finish
1	605	US3	03	Bright Brass
3	613	US10B	10B	Dark Oxide Bronze, Oil Rubbed
5	626	US26D	26D	Satin Chromium Plated

Freewheeling Lever

Warranty – Ten Year Warranty

Handing – Non-handed

Packaging – 6 per case

Strike – 4-7/8" ANSI (123.83mm)

Cylinder – Solid brass 6 pin, Arrow AR and Schlage CS Keyway, keyed different

Keys – 2 brass keys

Certification & Compliance:



- Arrow MLX Series Cylindrical Lever Locks are BHMA Grade 2 Certified, ANSI/BHMA A156.2, Series 4000
- All Arrow MLX Series Locks are U.L. and c.U.L. list for use on 3 hour, A label or lesser doors
- Meets American with Disabilities Act Requirements

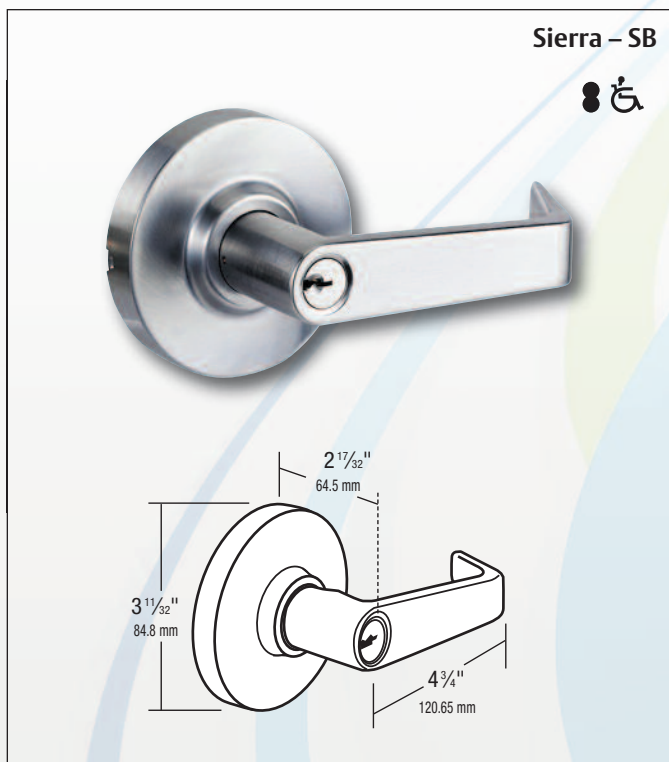

Design:



MLX Series Cylindrical Lever Locks

Professional Replacement Products

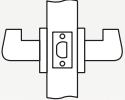
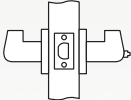
Functions:

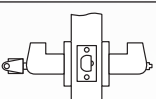
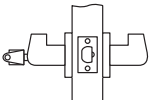
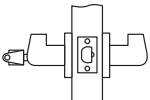
ARROW STANDARD	FUNCTION		DESCRIPTION
MLX01	Passage		Latchbolt operated by lever either side.
MLX72	Privacy		Latchbolt operated by lever either side except when inside turnbutton locks outside. Unlocked by rotating button or by using tool outside.
MLX08	1/2 Dummy Trim		Rigid trim for one side of door only. Used as pull or to match active trim.
MLX81	Entrance		Latchbolt operated by lever either side except when outside lever is locked by turn-button inside. When outside lever is locked, latchbolt operated by key outside or turning inside lever. Inside button must be manually released.
MLX82	Storeroom		Outside lever always locked. Latchbolt operated by key in outside lever, or by turning inside lever.
MLX87	Classroom		Latchbolt operated by lever either side except when key outside locks outside lever. Inside lever always free. Key outside locks/unlocks outside lever only.

Latches & Strikes:

Spring Latches 2-3/4" Backset

R23

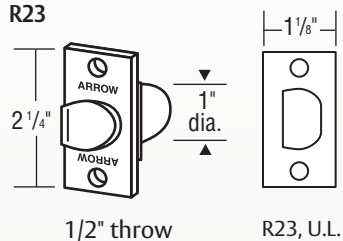

Dead Latches 2-3/4" Backset

R21

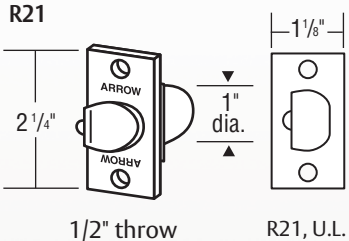

Strikes Standard with MLX Series

306

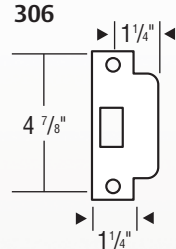

Installation:

161 prep for retrofit and secure installation.

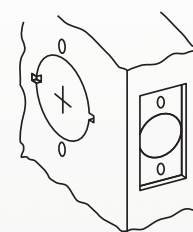

Order Example:

Example: To order a MLX Series entry function lockset with a Sierra design lever, satin stainless steel finish, with an R21 strike, and 2-3/4" deadlocking latch, keyed different:

Specify:

Standard:	<u>MLX</u>	<u>81</u>	<u>SB</u>	<u>26D</u>	<u>306</u>	<u>R21</u>	<u>KD</u>	<u>XXX</u>
	Series	Function	Design	Finish	Strike	Latch	Keying	Options (if required)

MLX Series Cylindrical Lever Locks

Professional Replacement Products

Features

Certification	BHMA A156.2, Series 4000, Grade 2, UL Listed
Freewheeling Lever Action	Standard
Door Thickness	Fits 1-3/8" to 1-3/4", factory set for 1-3/4"
Strike	ANSI 1-1/4" x 4-7/8"
Latch	2-3/4" backset, 1-1/8" front
Cylinder	Standard: 6-pin, solid brass, 2 brass keys; IC prep available
Handing	Non-handed
Case Quantity	6 per case
Average Case Weight	27 lbs.
Warranty	10 years

Available Finishes	Arrow Code	BHMA Code	U.S. Code
Bright Brass	03	605	US3
Dark Oxide Satin Bronze, Oil Rubbed	10BP	614	US10BL
Satin Chromium Plated	26D	626	US26D

How to Order

Function & Trim	MLX81-SB
Finish	MLX81-SB-26D
Strike	MLX81-SB-26D-306
Latch	MLX81-SB-26D-306-R21
Keying	MLX81-SB-26D-306-R21-KD-AR

Function	Description	03, 10B, 26D
MLX01-SB	Passage	\$115.00
MLX08-SB	Single Dummy	\$45.00
MLX72-SB	Privacy	\$125.00
MLX81-SB	Entrance/Office	\$135.00
MLX82-SB	Storeroom	\$135.00
MLX87-SB	Classroom	\$135.00

Latch Options	Spring Latch	Dead Latch	Price Add
2-3/4" backset x 1-1/8" front	R23	R21	Standard

Keying & Cylinder Options	Specify	Price Add
Keyed different, AR keyway	KD-AR	Standard
Keyed different, CS keyway	KD-CS	No add
Lock prepared to accept a 6- or 7-pin SFIC cylinder (not included)	IC	No add

Parts	Part No.	Price
Cylinder with tailpiece	700HD	\$23.34
Strike	306	\$23.98
Latch - 2-3/4" backset	R23 ¹ or R21 ²	\$14.00
Screw pack	QL-201	\$1.70
IC Tailpiece pack (6- & 7-pin tailpieces)	RLX-44-201	\$4.51
Alternate latch - 2-3/8" backset x 1" front (sold only as a separate part)	R22 ¹ or R20 ²	\$14.00

¹Used only with non-keyed functions

²Used only with keyed functions