



[WWW.ARTESIANSPAS.COM](http://WWW.ARTESIANSPAS.COM)

# This manual covers the following spas

**Grand Bahama**



**Grand Cayman**



**Antigua**



**Captiva**



**Saba**



**Bimini**



**Santa Cruz**



# TABLE OF CONTENTS

---

<b>Congratulations</b> .....	1
<b>Safety Warnings</b> .....	3
<b>Line Drawing Key</b> .....	6
<b>Spa Configuration and Specs</b> .....	7
<b>Pump Configurations</b> .....	40
<b>Electrical Requirements and Installation</b> .....	42
Electrical Wiring.....	44
Procedure for 120V Wiring.....	46
<b>Spa Start Up</b> .....	48
Selecting a Location.....	48
Inspection.....	49
Filling the Spa with Water.....	49
Turning the Power On.....	50
Verifying Water Circulation.....	50
Testing the GFCI Breaker.....	51
Priming the Pump.....	52
Water Preparation.....	52
<b>Topside Controller Instructions</b> .....	54
Initial Start up.....	54
Setting the Time of Day.....	54
Light.....	55
Setting Up Different Modes.....	55
Jets.....	55
Preset Filter Cycles.....	56
Optional Filter Cycles.....	56
Temperature Set.....	57
Freeze Protection.....	57
<b>Diagnostic Messages</b> .....	58
<b>Maintaining Your Spa</b> .....	60
Draining Your Spa.....	60
Pillow Care.....	60
Jet Care.....	61
Removing, Installing, and Cleaning Filters.....	62
Winterizing Your Spa.....	63
Replacing the Light Bulb.....	63
Spa Cabinet Care.....	64

# TABLE OF CONTENTS cont...

---

Cleaning Your Spa Interior.....	64
Cover Care.....	65
Chemical Treatment of Water.....	67
<b>Water Chemistry.....</b>	<b>68</b>
Water Treatment Glossary.....	68
Spa Chemicals Glossary.....	73
Maintaining the Proper pH.....	75
<b>Warranty Information.....</b>	<b>76</b>
<b>Interior Spa Diagram.....</b>	<b>82</b>

# Congratulations...

---

Congratulations on the purchase of your new Island spa by Artesian. We know you will enjoy your spa. Although spas are relaxing and fun, we believe they can be an indispensable part of a healthy lifestyle. The spa lifestyle is one that encourages health and well-being.

Owning a spa brings some responsibility. With proper care, your spa will provide years of enjoyment and therapy for your family and friends. Please take time to read and understand all of the instructions provided before you install your Artesian spa. This owner's manual is meant to be a supplement to the training you should receive from your dealer when you purchase and start up your spa for the first time.

Please remember your spa is a powerful piece of electrical equipment. It is extremely important that you have it properly installed to ensure safe use. This manual explains safety precautions, installation instructions, and operating and maintenance procedures. If you have any questions regarding this manual, please call your competent Artesian spa dealer, who will be happy to further assist you.

**Make sure you  
visit our website at [www.artesianspas.com](http://www.artesianspas.com)  
and register your new Artesian spa.**

For your future reference and convenience, please record the Serial and Model number along with the installation date in the spaces provided below. **STORE THIS MANUAL WHERE YOU CAN EASILY FIND IT WHEN NEEDED.** The serial and model numbers are mounted on the base of the equipment enclosure area, as shown below.

Spa Serial Number \_\_\_\_\_

Spa Model Number \_\_\_\_\_

Spa Installation Date \_\_\_\_\_

Dealer Name, Address, and Telephone Number

---

---

---

Diagram of Where to Find Serial Number



Serial Number Information

# SAFETY WARNINGS

---

**PLEASE TAKE THE TIME TO READ ALL OF THESE WARNINGS AND CAUTIONS PRIOR TO USING YOUR SPA.**

PLEASE, be a responsible spa owner. When installing and using this spa, always adhere to basic safety precautions. Be sure to list emergency telephone numbers at the telephone nearest the spa, including physician, hospital, ambulance, police, and the fire department. Be certain to explain safety precautions to all new or occasional users of your spa. Remember, they may not be aware of the possible risks associated with the spa water temperature.

Have at least one family member learn CPR (cardiopulmonary resuscitation). IT COULD SAVE A LIFE!

1. READ AND FOLLOW ALL INSTRUCTIONS!

2. **WARNING** - To reduce the risk of injury, do not permit children to use this product unless they are closely supervised at all times.

3. A wire connector is provided on this unit to connect a minimum 8 AWG (8.4 mm ) solid copper conductor between this unit and any metal equipment, metal enclosures of electrical equipment, metal water pipe, or conduit within 5 feet (1.5 m) of the unit.

4. **DANGER - Risk of Accidental Drowning** - Extreme caution must be exercised to prevent unauthorized access by children. To avoid accidents, ensure that children cannot use this spa unless they are supervised at all times.

5. **DANGER - Risk of Injury** - The suction fittings in this area are sized to match the specific water flow created by the pump. Should the need arise to replace the suction fittings or the pump, be sure the flow rates are compatible.

Never operate spa if the suction fittings are broken or missing. Never replace a suction fitting with one rated less than the flow rate marked on the original suction fitting.

6. **DANGER - Risk of Electrical Shock** - Install at least 5 feet (1.5 m) from all metal surfaces. As an alternative, a spa may be within 5 feet of metal surfaces if each metal surface is permanently connected by a minimum 8 AWG (8.4 mm ) solid copper conductor to the wire connector on the terminal box that is provided for this purpose.

7. **DANGER - Risk of Electric Shock** - Do not permit any electrical appliance such as a light, telephone, radio, or television, within 5 feet (1.5 m) of a spa.

# **SAFETY WARNINGS cont...**

---

## **8. WARNING - To reduce the risk of injury:**

**a)** The water in a spa should never exceed 40°C (104°F). Water temperatures between 38°C (100°F) and 40°C are considered safe for a healthy adult. Lower water temperatures are recommended for young children and when spa use exceeds 10 minutes.

**b)** Since excessive water temperatures have a high potential for causing fetal damage during the early months of pregnancy, pregnant or possibly pregnant women should limit spa water temperatures to 38° C (100°F).

**c)** Before entering a spa, the user should measure the water temperature with an accurate thermometer since the tolerance of water temperature regulating devices varies.

**d)** The use of alcohol, drugs, or medication before or during spa use may lead to unconsciousness with the possibility of drowning.

**e)** Obese persons and persons with a history of heart disease, low or high blood pressure, circulatory system problems, or diabetes should consult a physician before using a spa.

**f)** Persons using medication should consult a physician before using a spa since some medication may induce drowsiness while other medication may affect heart rate, blood pressure, and circulation.

## **AUDIO COMPONENT WARNINGS**

---

**Spas equipped with the Audio system should follow these guidelines for safety:**

**1. CAUTION** - Risk of Electrical Shock - Do not leave compartment door open.

**2. CAUTION** - Risk of Electrical Shock - Replace components only with identical components.

**3.** Do not operate the audio controls while inside the spa.















**4. WARNING - Prevent Electrocutiion** - Do not connect any auxillary components (for example cable, additional speakers, headphones, additional audio/video components, etc.) to the system.

**5.** These units are not provided with an outdoor antenna; when provided, it should be installed in accordance with Article 810 of the National Electrical Code, ANSI/NFPA 70.

**6.** Do not service this product yourself as opening or removing covers may expose you to dangerous voltage or other risk of injury. Refer all servicing to qualified service personnel.

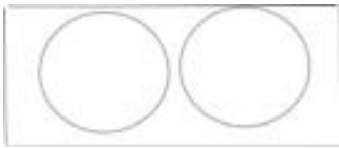
**KEEP THESE SAFETY INSTRUCTIONS IN A CONVENIENT AND READILY ACCESSIBLE LOCATION!!**

# LINE DRAWING KEY

Name of Component	Symbol for Component
Whirlpool 5in	
Helix Roto 4.5"	
Helix Roto 4"	
Helix Direct 4"	
Helix Jet 2.75in	
Helix Direct 3"	
Helix Direct 2"	
Jumbo Storm Massage	
Helix Massage 3"	
Helix Direct 5"	
Filter	
Speaker	
Diverter Control	
Topside Control	

Line Drawings may not be exact models of your particular spa. Certain options may be shown that are not included on your spa.

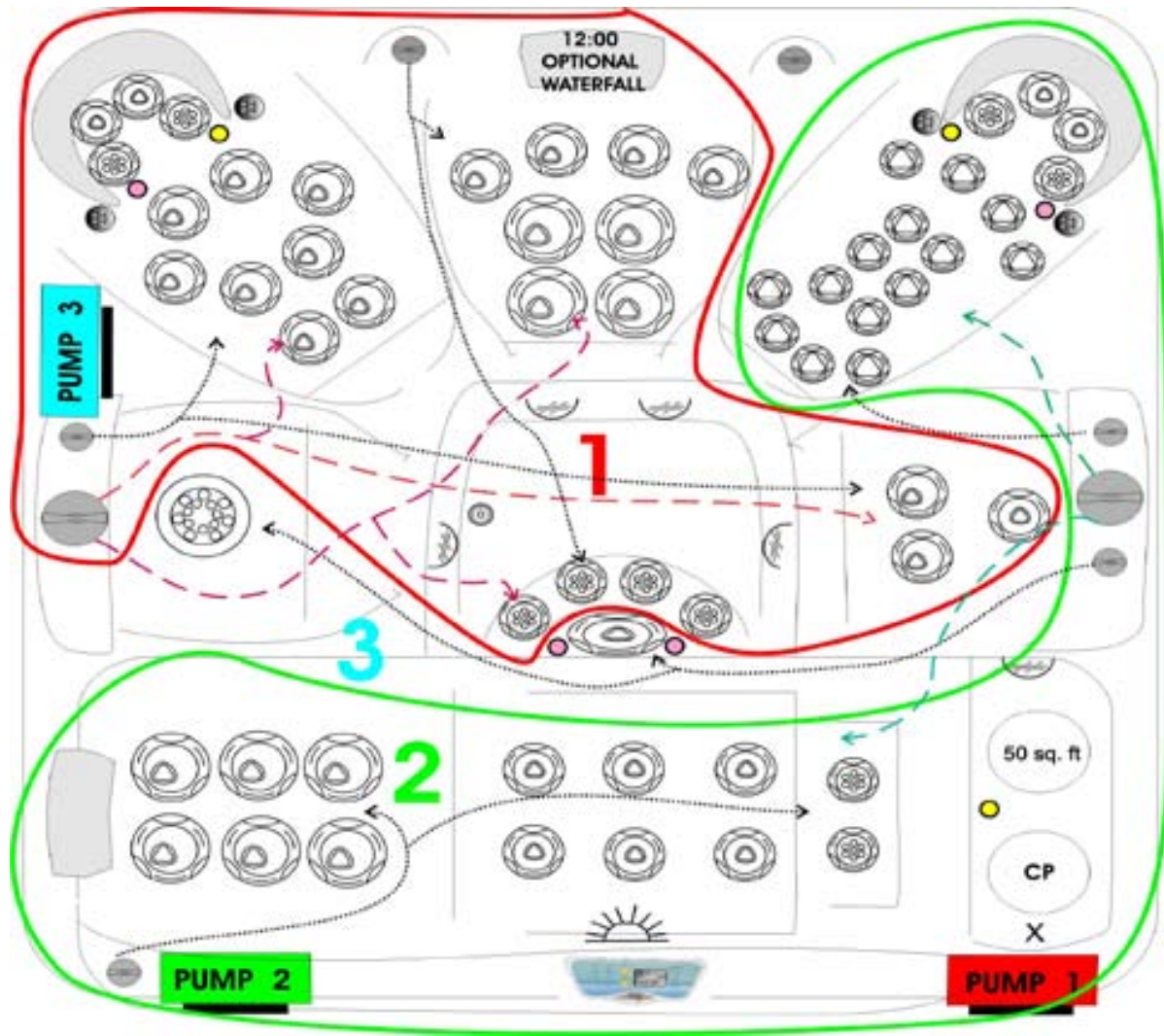

# Grand Bahama 62-3P

	60Hz	50Hz
Volume	450 gal	1703 l
Weight (dry/filled)	783/4531 lbs	360/2084 kg
Dimensions	91x91x36in	2.31x2.31x0.91 m
Control	MVS504DZ	MGS504SZ
Heater	5.5kW Flo-Thru	2.0kW Flo-Thru
Circulation System	optional	optional
Ozone	optional	optional
Cartridge Filter	2	2

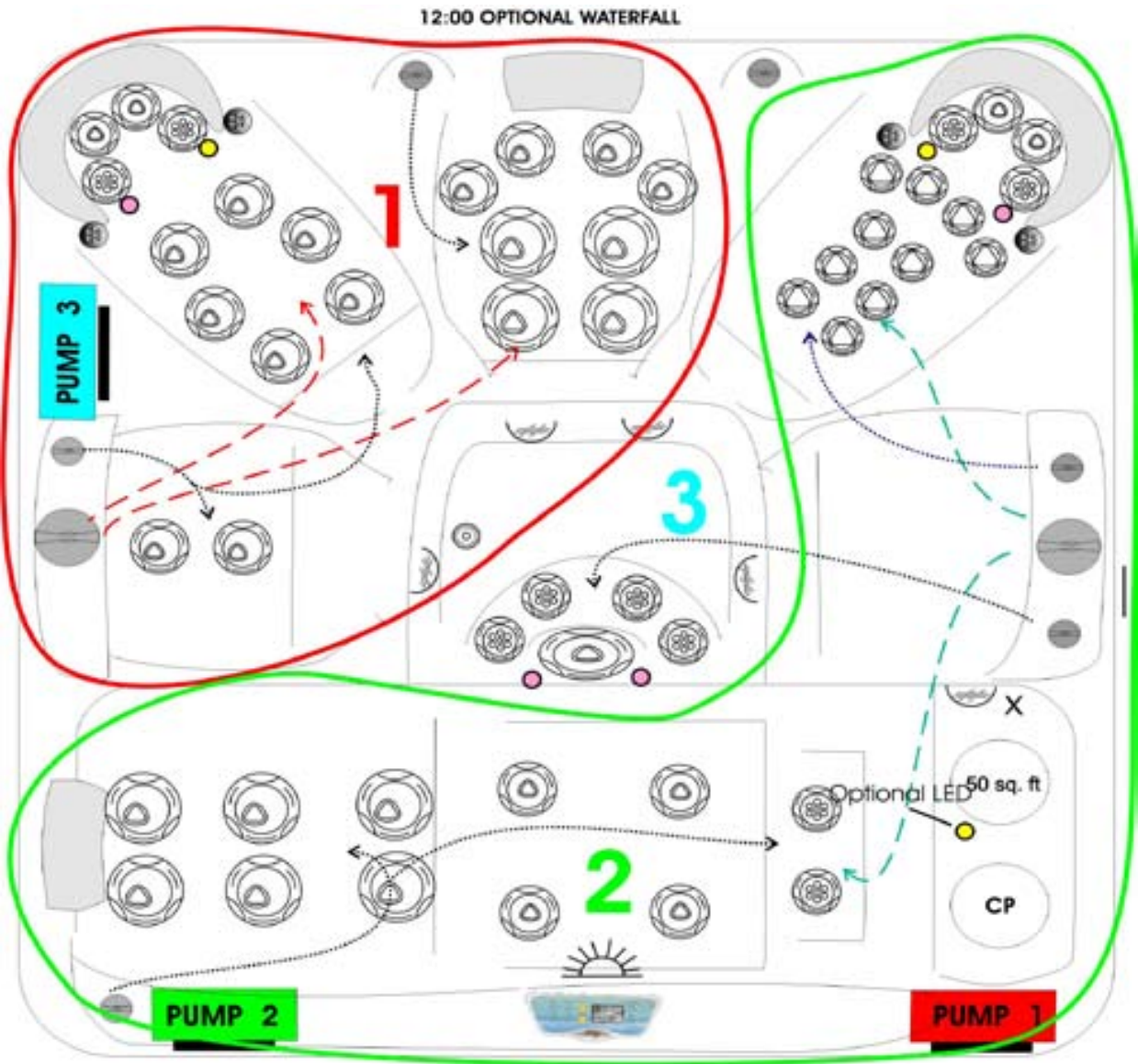

# Grand Bahama 52-3P

	60Hz	50Hz
Volume	450 gal	1703 l
Weight (dry/filled)	783/4531 lbs	360/2084 kg
Dimensions	91x91x36in	2.31x2.31x0.91 m
Control	MVS504DZ	MGS504SZ
Heater	5.5kW Flo-Thru	2.0kW Flo-Thru
Circulation System	optional	optional
Ozone	optional	optional
Cartridge Filter	2	2

12:00 OPTIONAL WATERFALL

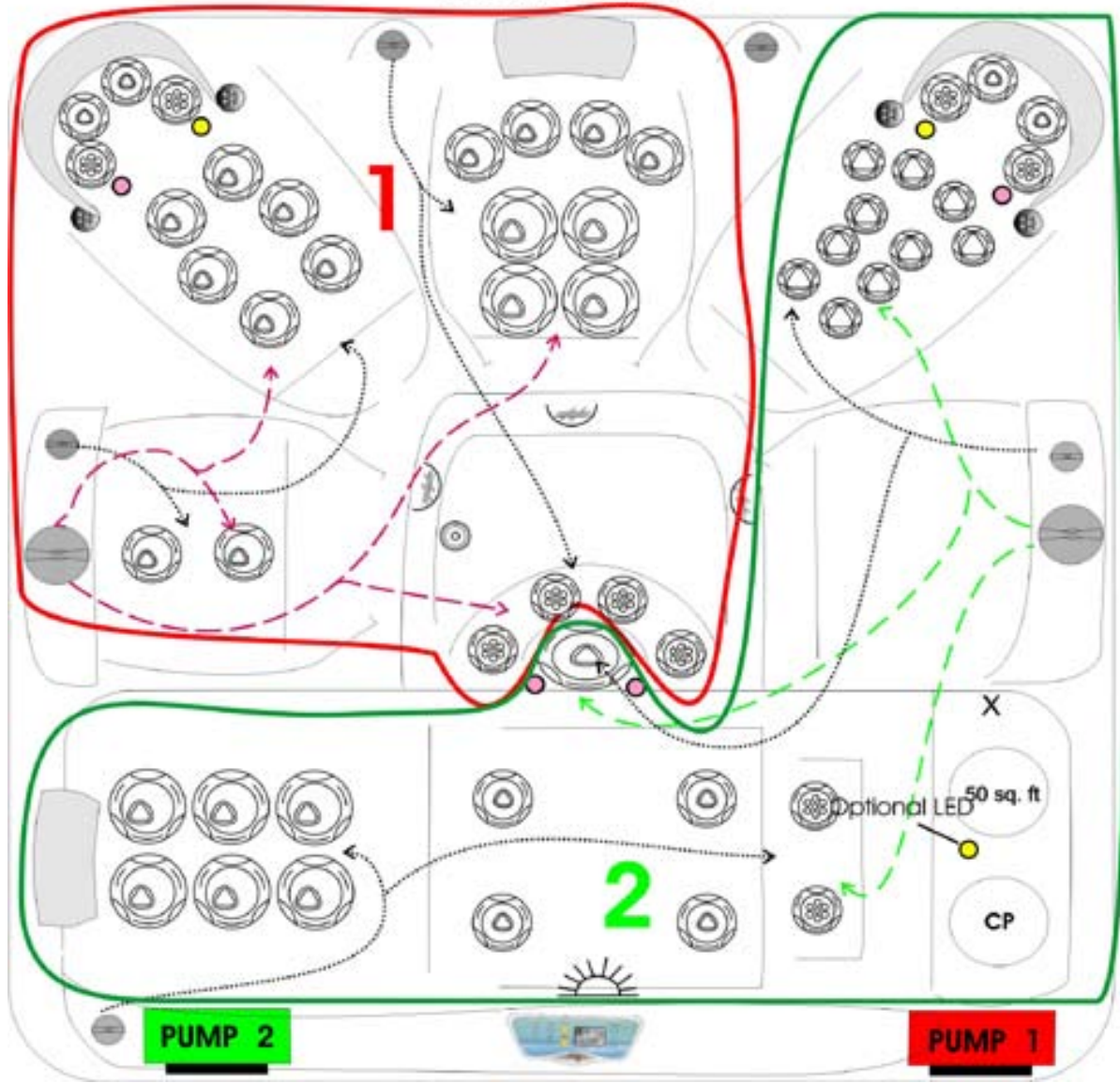

# Grand Bahama 52

	60Hz	50Hz
Volume	450 gal	1703 l
Weight (dry/filled)	783/4531 lbs	360/2084 kg
Dimensions	91x91x36in	2.31x2.31x0.91 m
Control	MVS504DZ	MGS504SZ
Heater	5.5kW Flo-Thru	2.0kW Flo-Thru
Circulation System	optional	optional
Ozone	optional	optional
Cartridge Filter	2	2

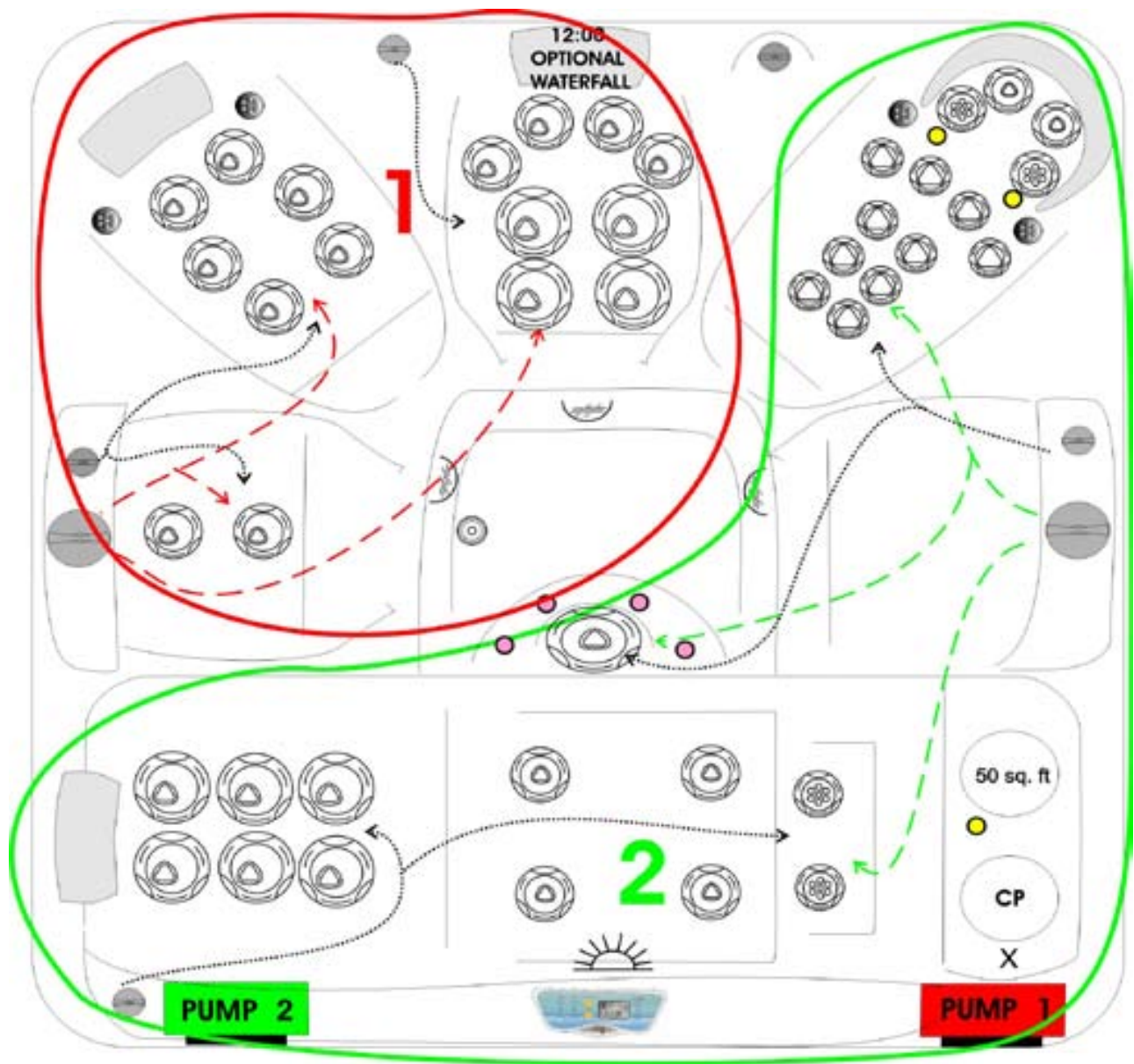

# Grand Bahama 44

	60Hz	50Hz
Volume	450 gal	1703 l
Weight (dry/filled)	783/4531 lbs	360/2084 kg
Dimensions	91x91x36in	2.31x2.31x0.91 m
Control	MVS504DZ	MGS504SZ
Heater	5.5kW Flo-Thru	2.0kW Flo-Thru
Circulation System	optional	optional
Ozone	optional	optional
Cartridge Filter	2	2

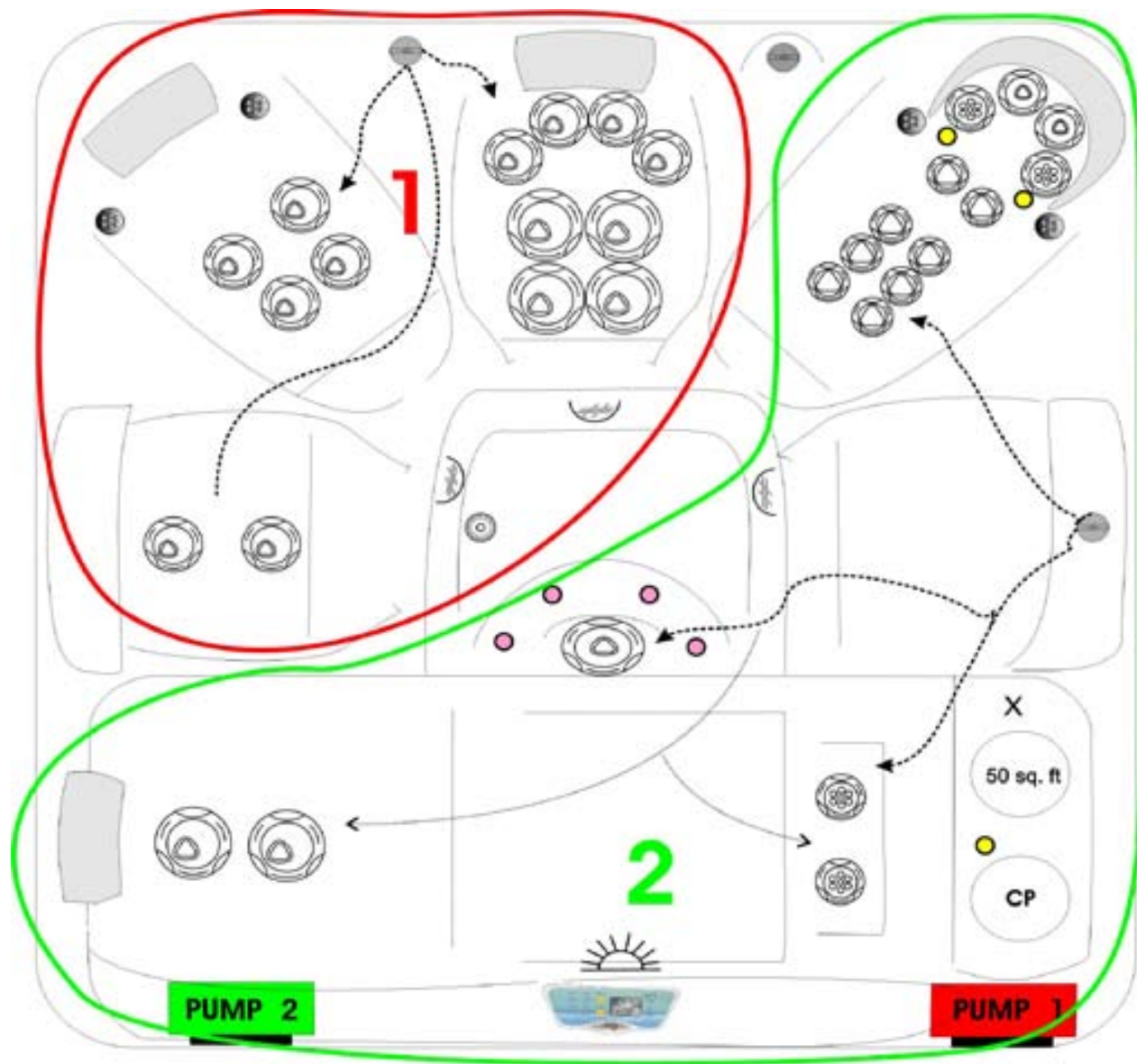

# Grand Bahama 32-

	60Hz	50Hz
Volume	450 gal	1703 l
Weight (dry/filled)	783/4531 lbs	360/2084 kg
Dimensions	91x91x36in	2.31x2.31x0.91 m
Control	MVS504DZ	MGS504SZ
Heater	5.5kW Flo-Thru	2.0kW Flo-Thru
Circulation System	optional	optional
Ozone	optional	optional
Cartridge Filter	2	2

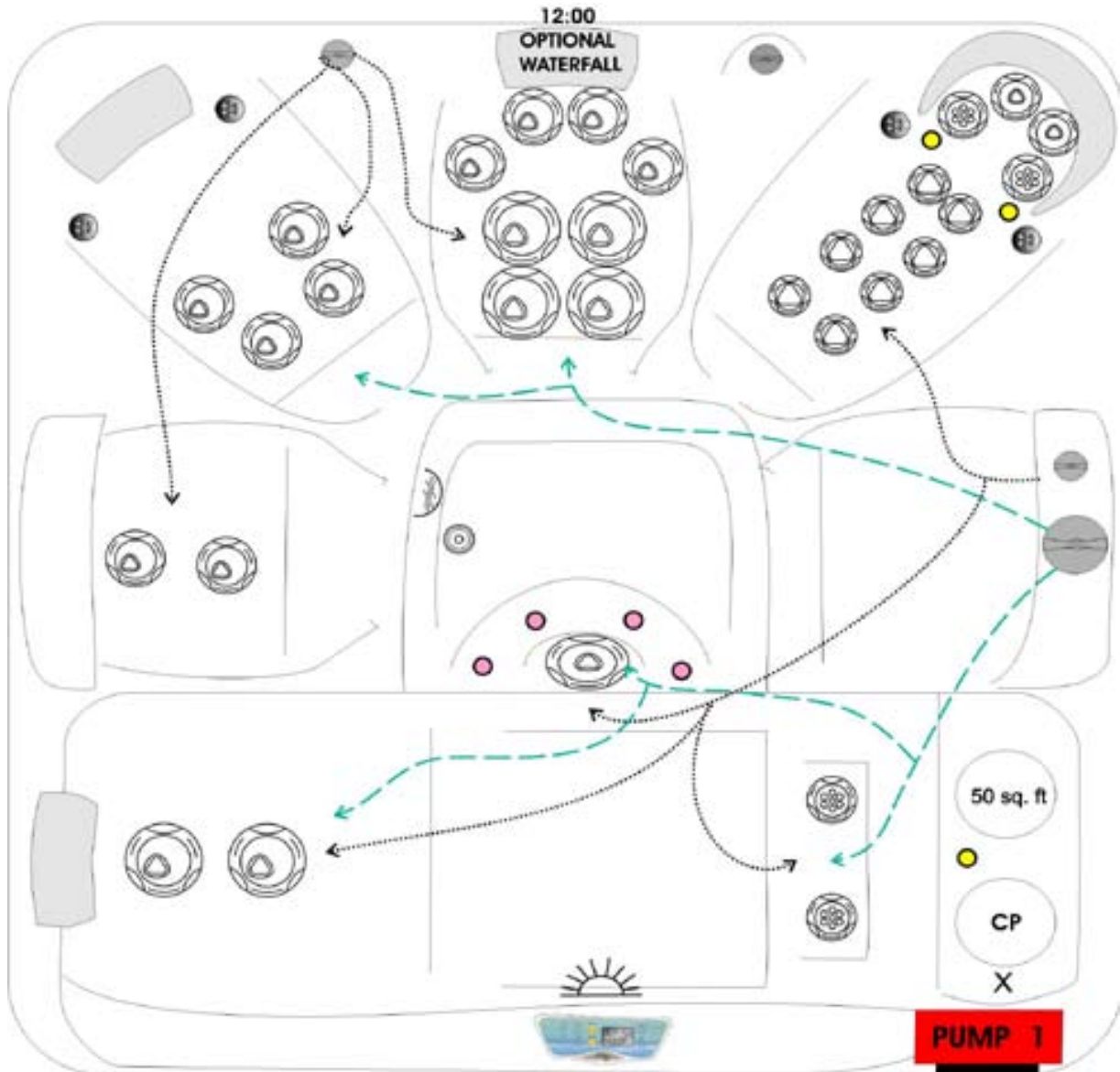

# Grand Bahama 32

	60Hz	50Hz
Volume	450 gal	1703 l
Weight (dry/filled)	783/4531 lbs	360/2084 kg
Dimensions	91x91x36in	2.31x2.31x0.91 m
Control	MVS504DZ	MGS504SZ
Heater	5.5kW Flo-Thru	2.0kW Flo-Thru
Circulation System	optional	optional
Ozone	optional	optional
Cartridge Filter	2	2

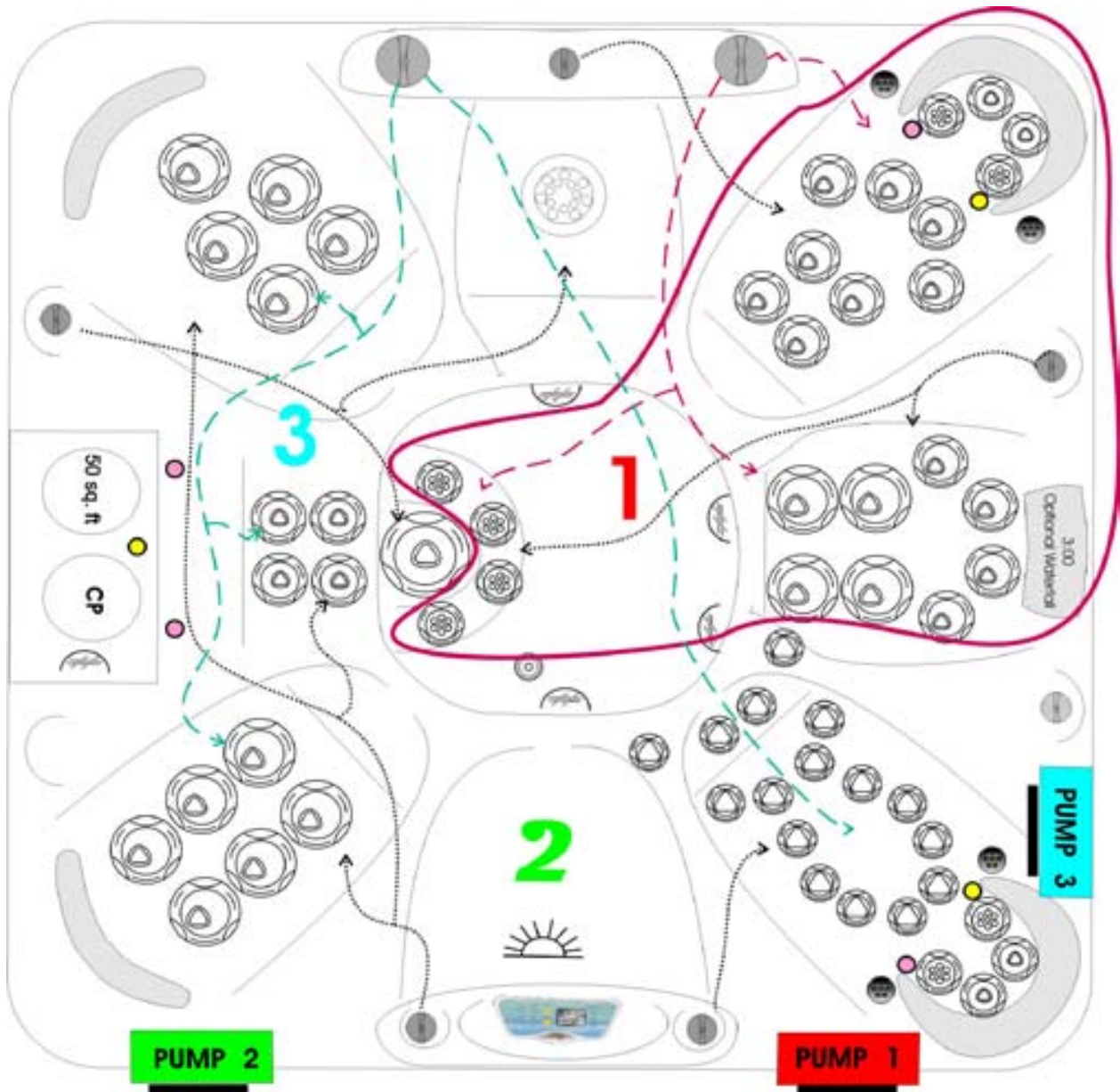

# Grand Cayman 62-3P

	60Hz	50Hz
Volume	475 gal	1797 l
Weight (dry/filled)	782/4738 lbs	359.7/2179 kg
Dimensions	91x91x36in	2.31x2.31x0.91 m
Control	MVS504DZ	MGS504SZ
Heater	5.5kW Flo-Thru	2.0kW Flo-Thru
Circulation System	optional	optional
Ozone	optional	optional
Cartridge Filter	2	2

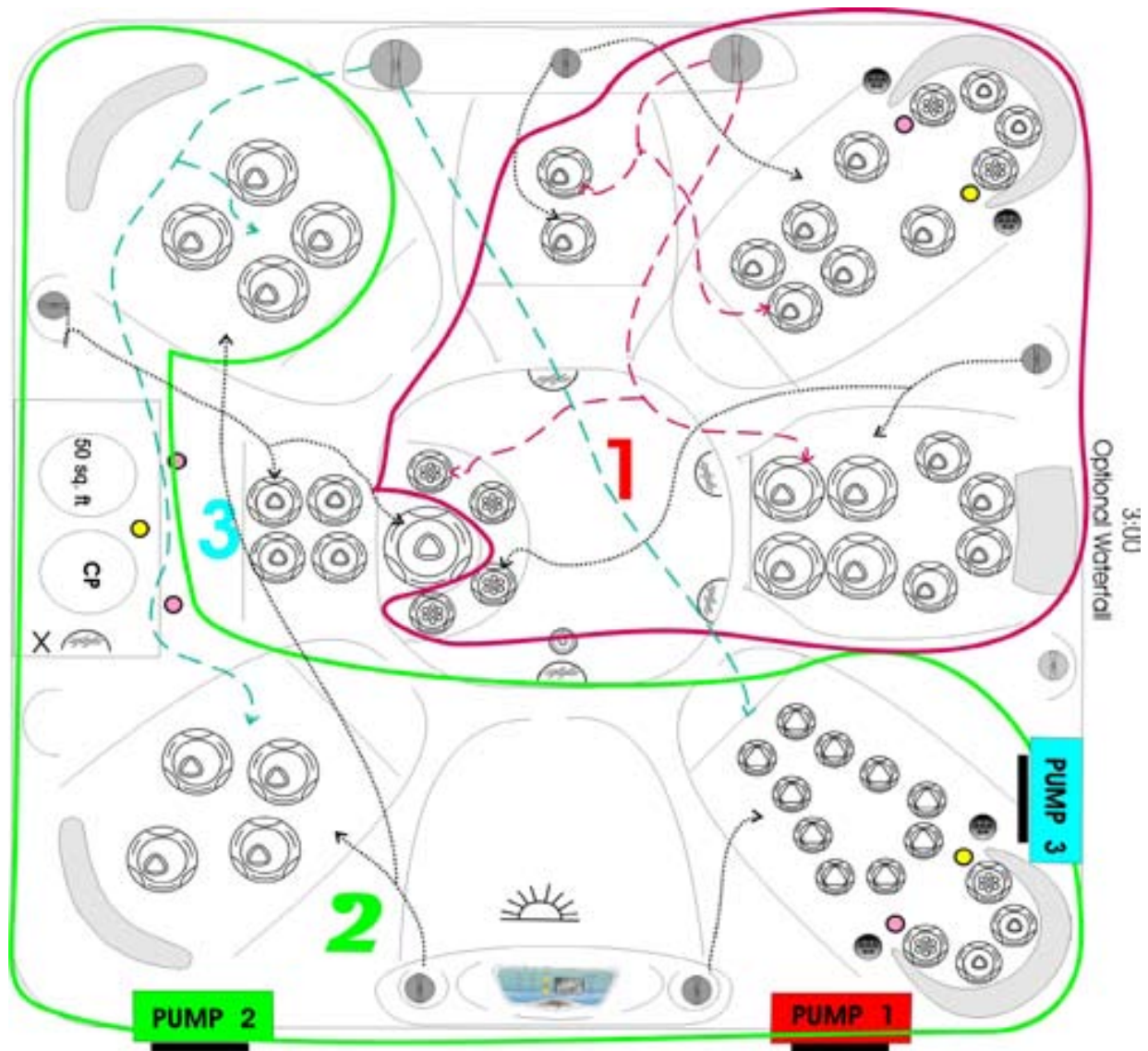

# Grand Cayman 52-3P

	60Hz	50Hz
Volume	475 gal	1797 l
Weight (dry/filled)	782/4738 lbs	359.7/2179 kg
Dimensions	91x91x36in	2.31x2.31x0.91 m
Control	MVS504DZ	MGS504SZ
Heater	5.5kW Flo-Thru	2.0kW Flo-Thru
Circulation System	optional	optional
Ozone	optional	optional
Cartridge Filter	2	2

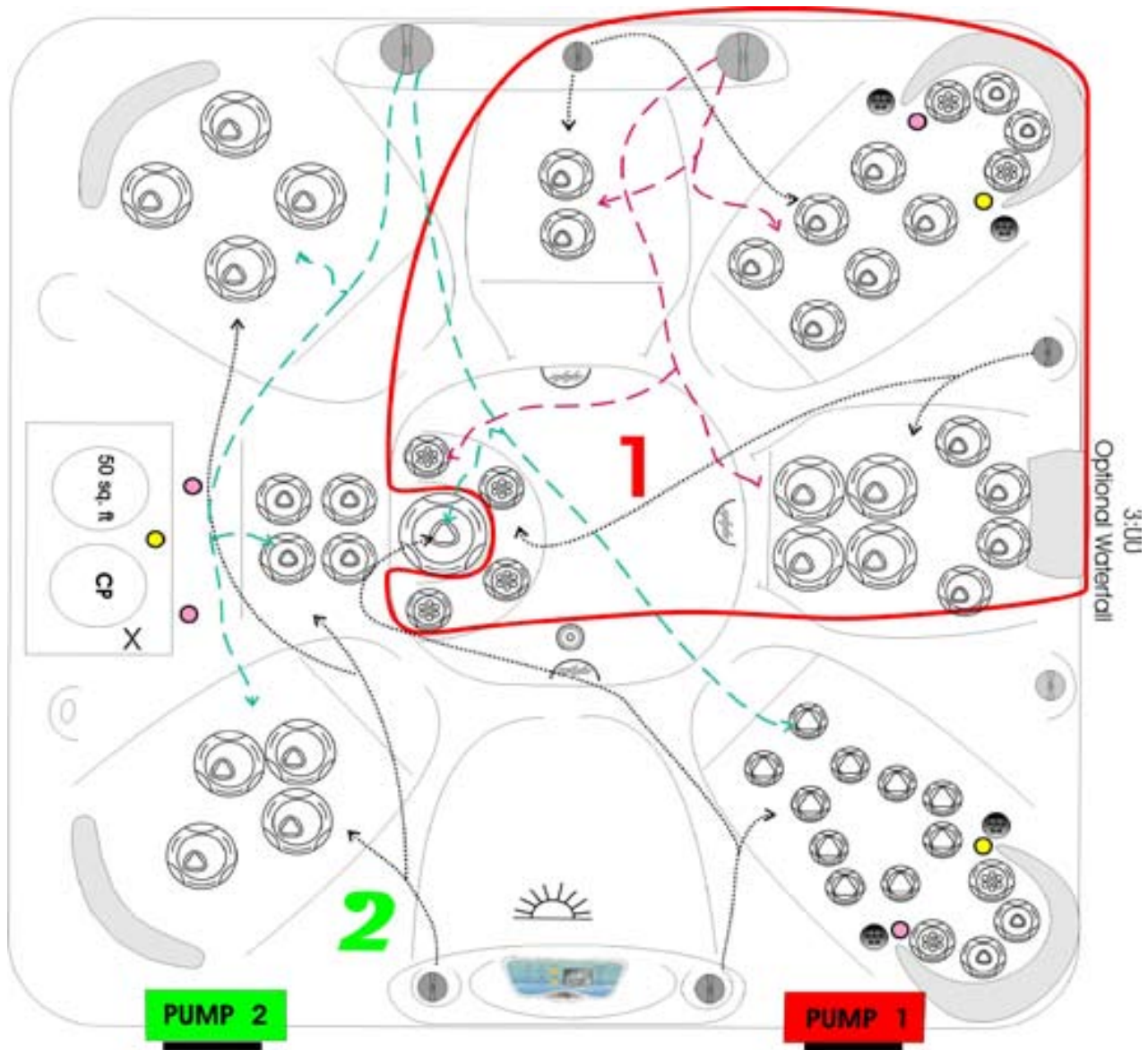

# Grand Cayman 52

	60Hz	50Hz
Volume	475 gal	1797 l
Weight (dry/filled)	782/4738 lbs	359.7/2179 kg
Dimensions	91x91x36in	2.31x2.31x0.91 m
Control	MVS504DZ	MGS504SZ
Heater	5.5kW Flo-Thru	2.0kW Flo-Thru
Circulation System	optional	optional
Ozone	optional	optional
Cartridge Filter	2	2

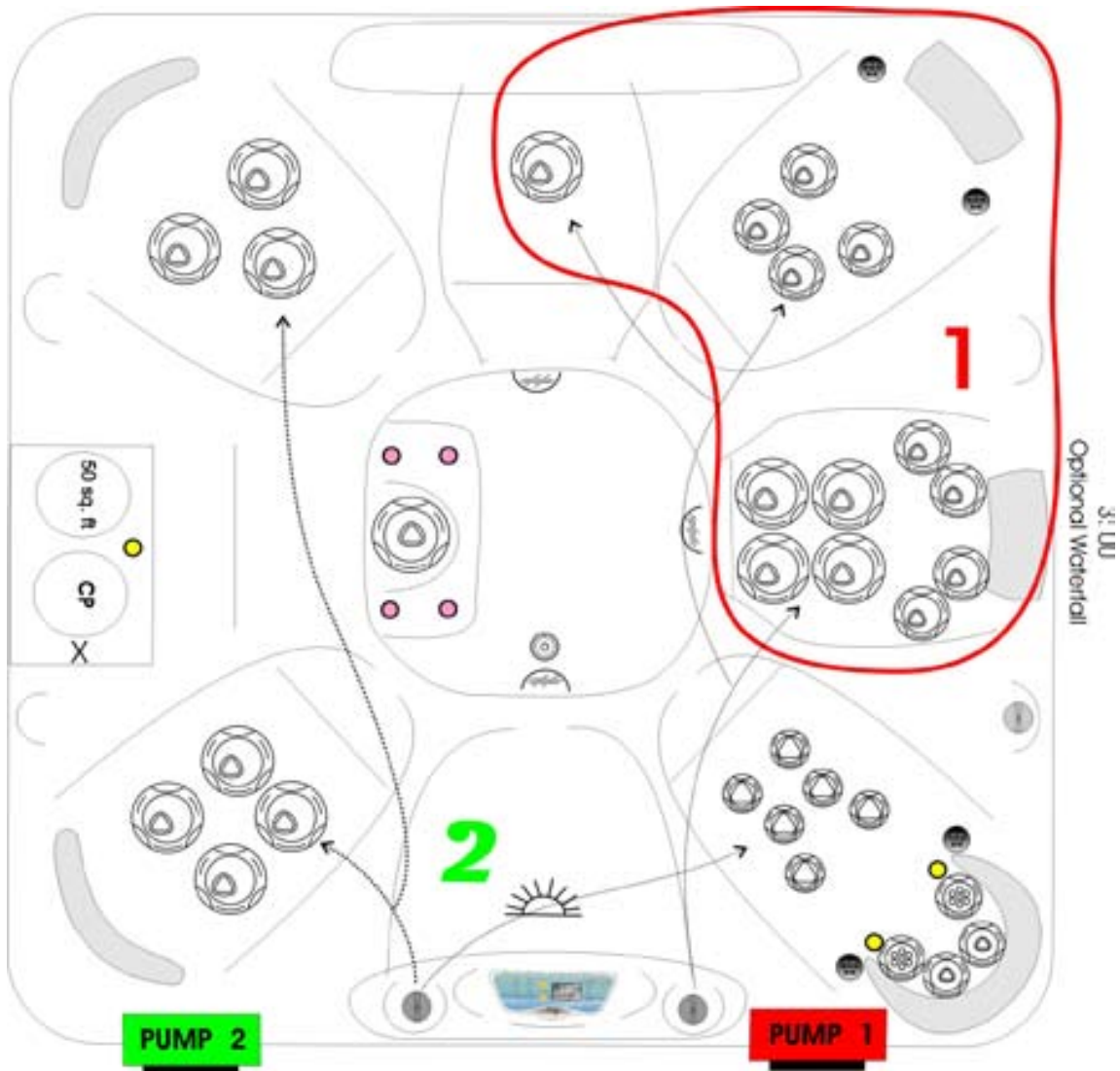

# Grand Cayman 44

	60Hz	50Hz
Volume	475 gal	1797 l
Weight (dry/filled)	782/4738 lbs	359.7/2179 kg
Dimensions	91x91x36in	2.31x2.31x0.91 m
Control	MVS504DZ	MGS504SZ
Heater	5.5kW Flo-Thru	2.0kW Flo-Thru
Circulation System	optional	optional
Ozone	optional	optional
Cartridge Filter	2	2

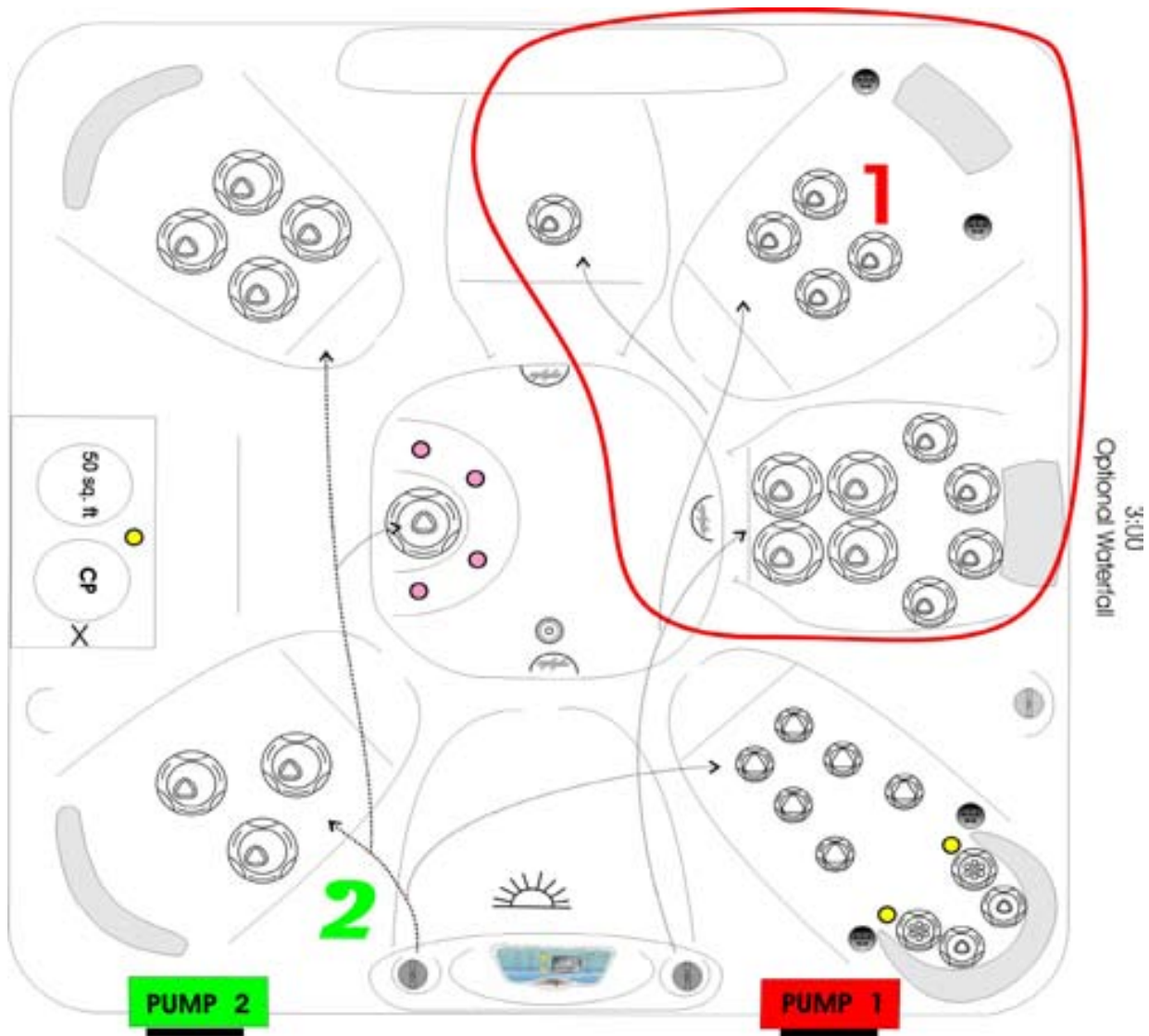

# Grand Cayman 32-2P

	60Hz	50Hz
Volume	475 gal	1797 l
Weight (dry/filled)	782/4738 lbs	359.7/2179 kg
Dimensions	91x91x36in	2.31x2.31x0.91 m
Control	MVS504DZ	MGS504SZ
Heater	5.5kW Flo-Thru	2.0kW Flo-Thru
Circulation System	optional	optional
Ozone	optional	optional
Cartridge Filter	2	2

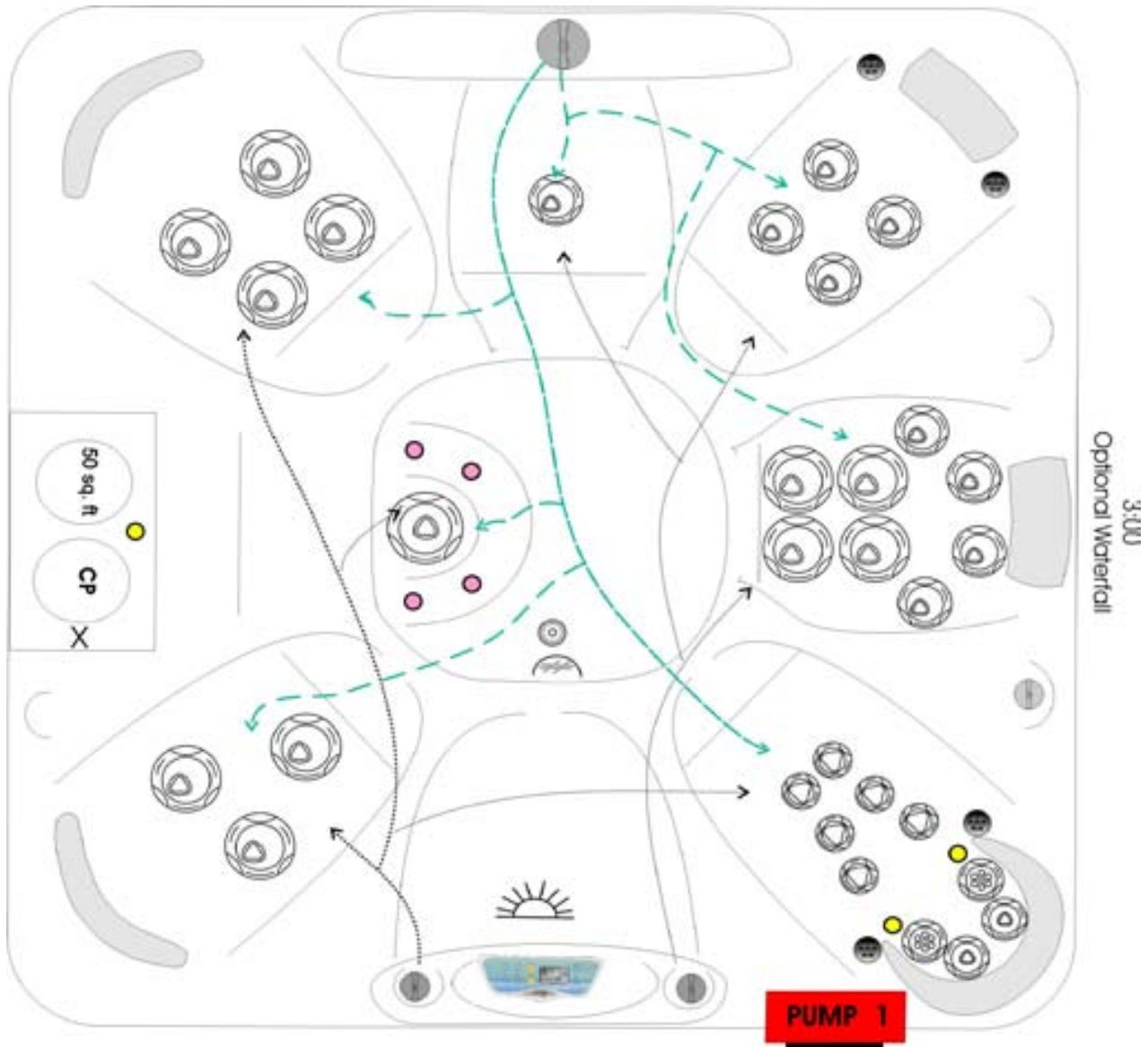

# Grand Cayman 32

	60Hz	50Hz
Volume	475 gal	1797 l
Weight (dry/filled)	782/4738 lbs	359.7/2179 kg
Dimensions	91x91x36in	2.31x2.31x0.91 m
Control	MVS504DZ	MGS504SZ
Heater	5.5kW Flo-Thru	2.0kW Flo-Thru
Circulation System	optional	optional
Ozone	optional	optional
Cartridge Filter	2	2

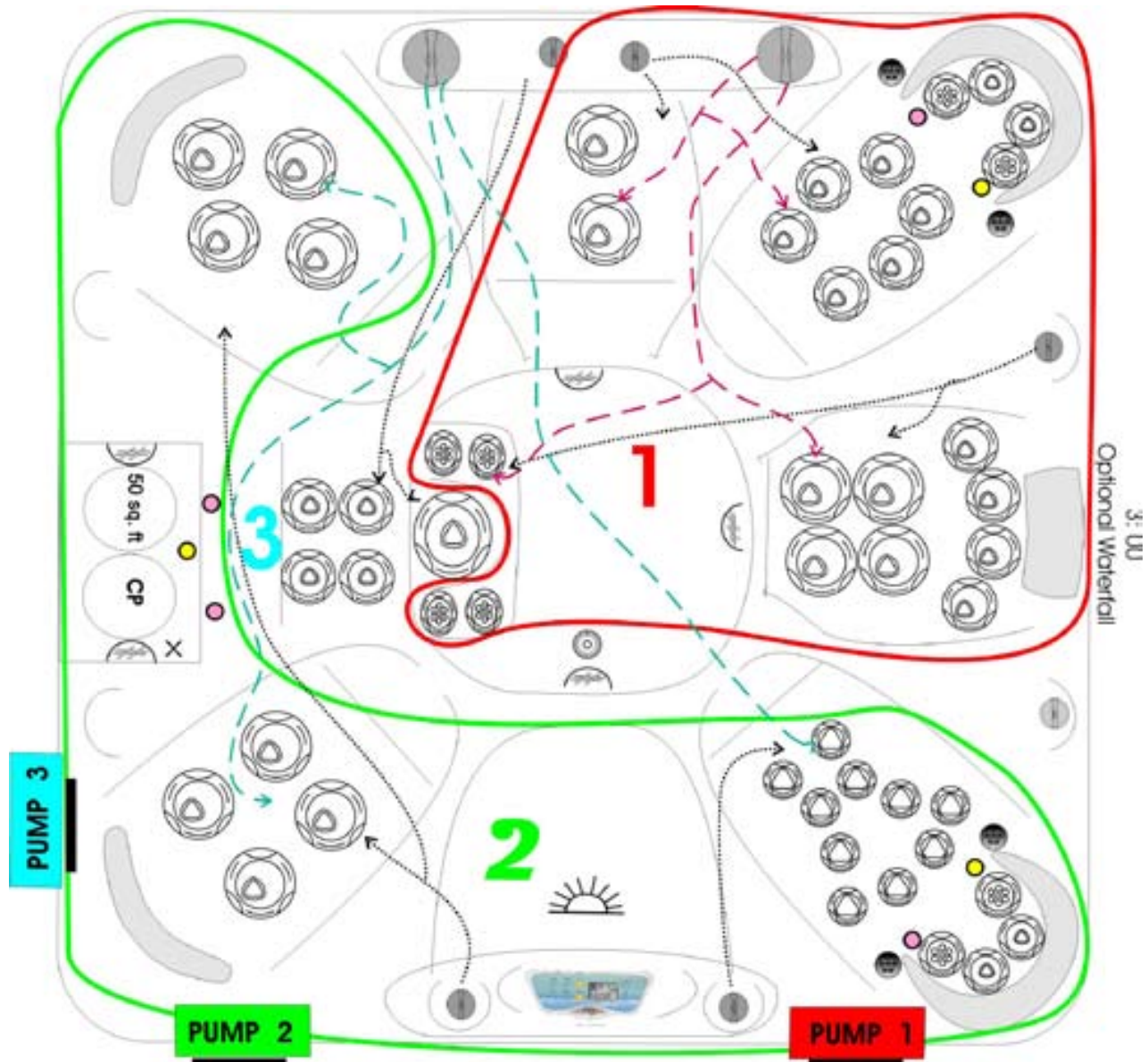

# Captiva 52-3P

	60Hz	50Hz
Volume	350 gal	1324 l
Weight (dry/filled)	550/ 3465lbs	253/1593 kg
Dimensions	82x82x36in	2.08x2.08x0.91 m
Control	MVS504DZ	MGS504SZ
Heater	5.5kW Flo-Thru	2.0kW Flo-Thru
Circulation System	optional	optional
Ozone	optional	optional
Cartridge Filter	2	2

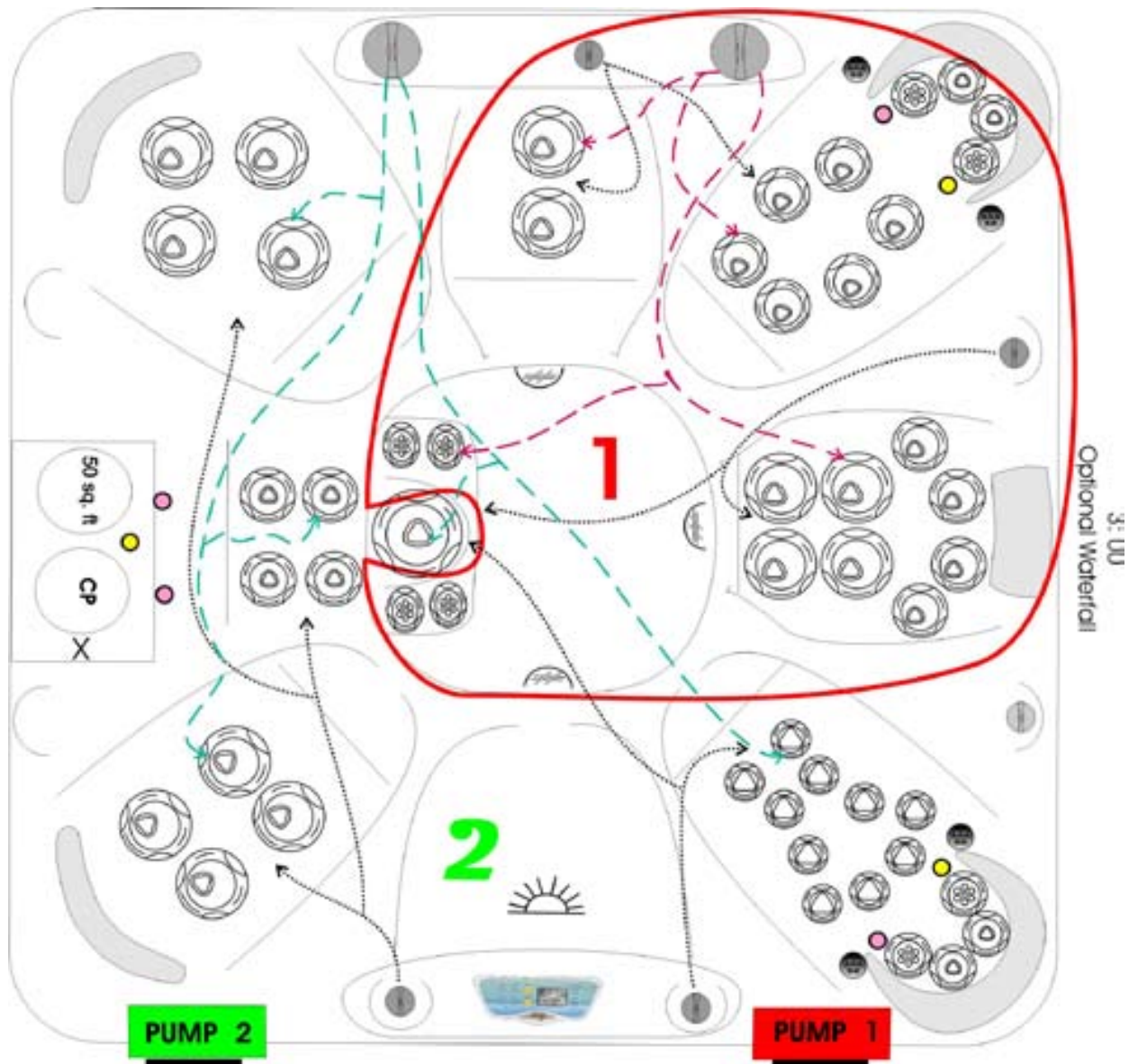

# Captiva 52-2P

	<b>60Hz</b>	<b>50Hz</b>
Volume	350 gal	1324 l
Weight (dry/filled)	550/ 3465lbs	253/1593 kg
Dimensions	82x82x36in	2.08x2.08x0.91 m
Control	MVS504DZ	MGS504SZ
Heater	5.5kW Flo-Thru	2.0kW Flo-Thru
Circulation System	optional	optional
Ozone	optional	optional
Cartridge Filter	2	2

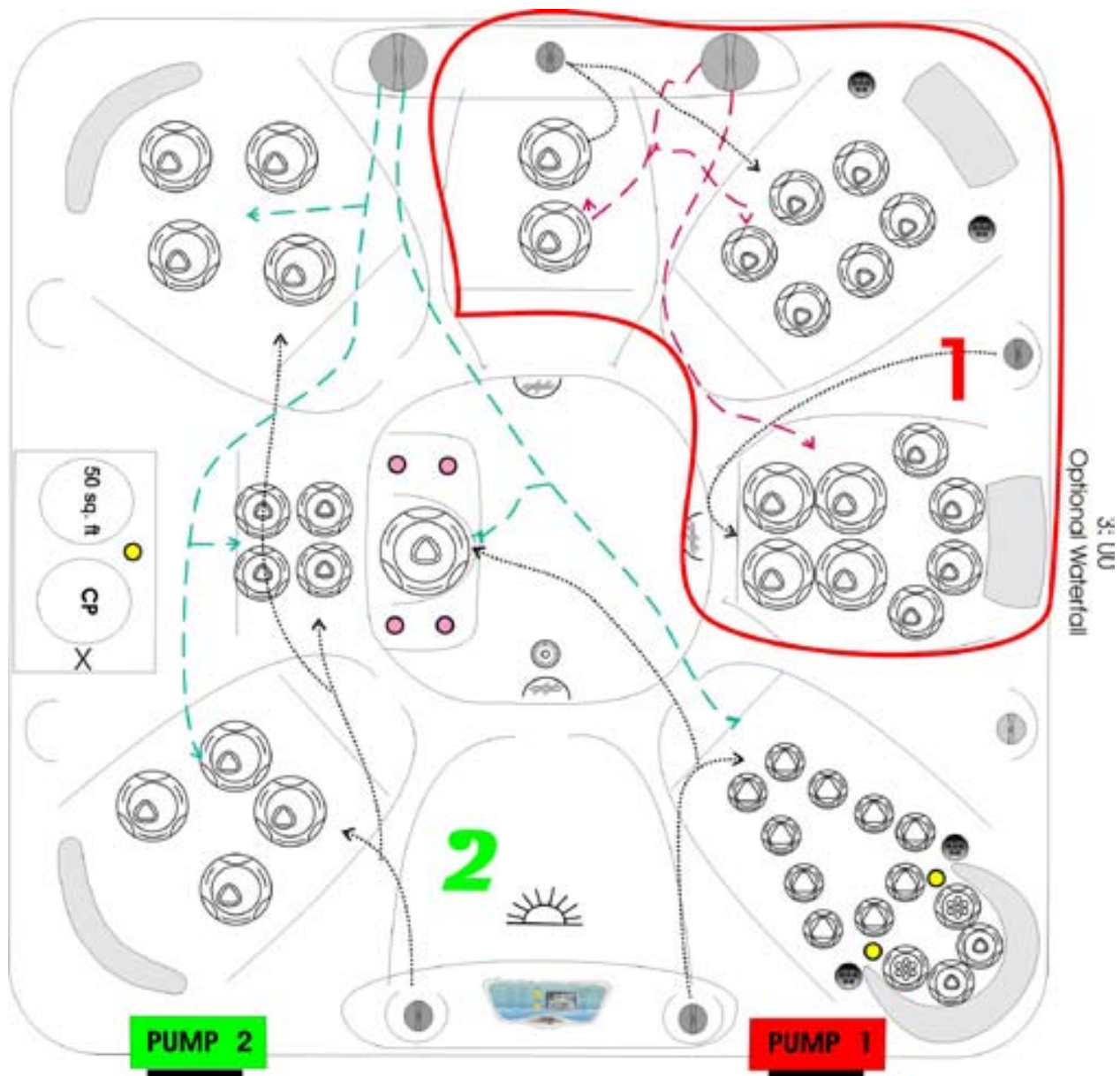

# Captiva 44

	<b>60Hz</b>	<b>50Hz</b>
Volume	350 gal	1324 l
Weight (dry/filled)	550/ 3465lbs	253/1593 kg
Dimensions	82x82x36in	2.08x2.08x0.91 m
Control	MVS504DZ	MGS504SZ
Heater	5.5kW Flo-Thru	2.0kW Flo-Thru
Circulation System	optional	optional
Ozone	optional	optional
Cartridge Filter	2	2

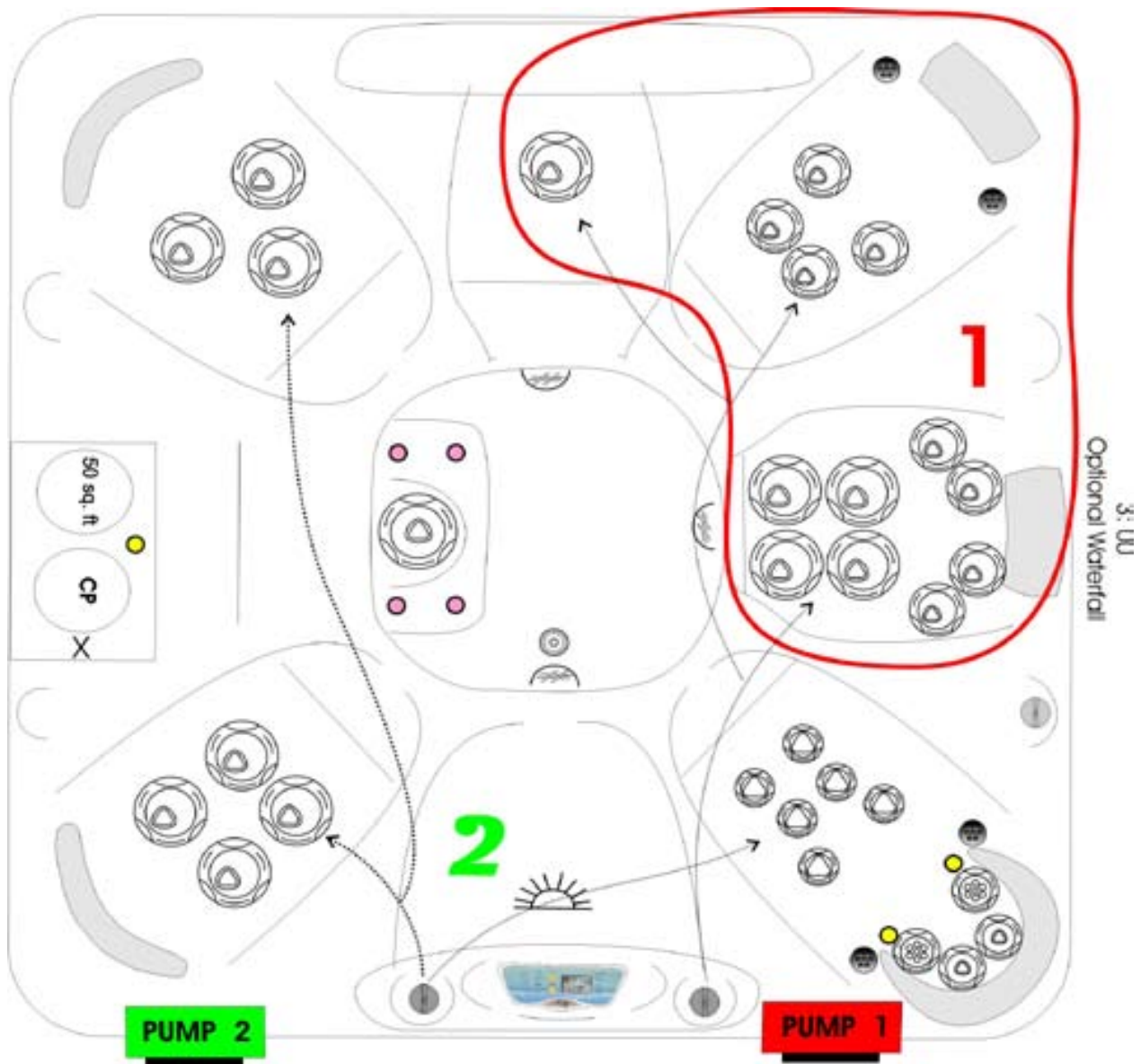

# Captiva 32-2P

	<b>60Hz</b>	<b>50Hz</b>
Volume	350 gal	1324 l
Weight (dry/filled)	550/ 3465lbs	253/1593 kg
Dimensions	82x82x36in	2.08x2.08x0.91 m
Control	MVS504DZ	MGS504SZ
Heater	5.5kW Flo-Thru	2.0kW Flo-Thru
Circulation System	optional	optional
Ozone	optional	optional
Cartridge Filter	2	2

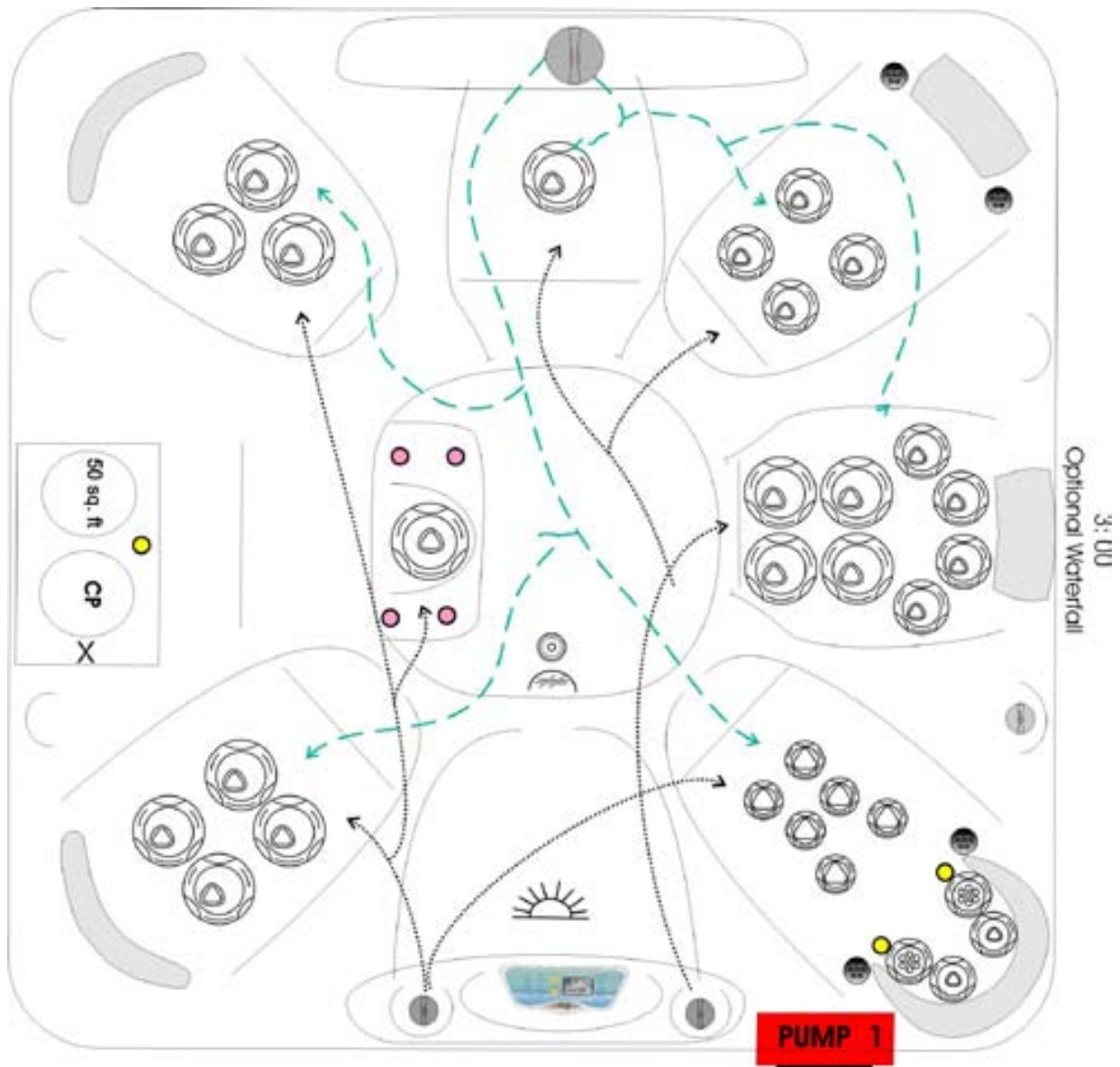

# Captiva 32-1P

	60Hz	50Hz
Volume	350 gal	1324 l
Weight (dry/filled)	550/ 3465lbs	253/1593 kg
Dimensions	82x82x36in	2.08x2.08x0.91 m
Control	MVS504DZ	MGS504SZ
Heater	5.5kW Flo-Thru	2.0kW Flo-Thru
Circulation System	optional	optional
Ozone	optional	optional
Cartridge Filter	2	2

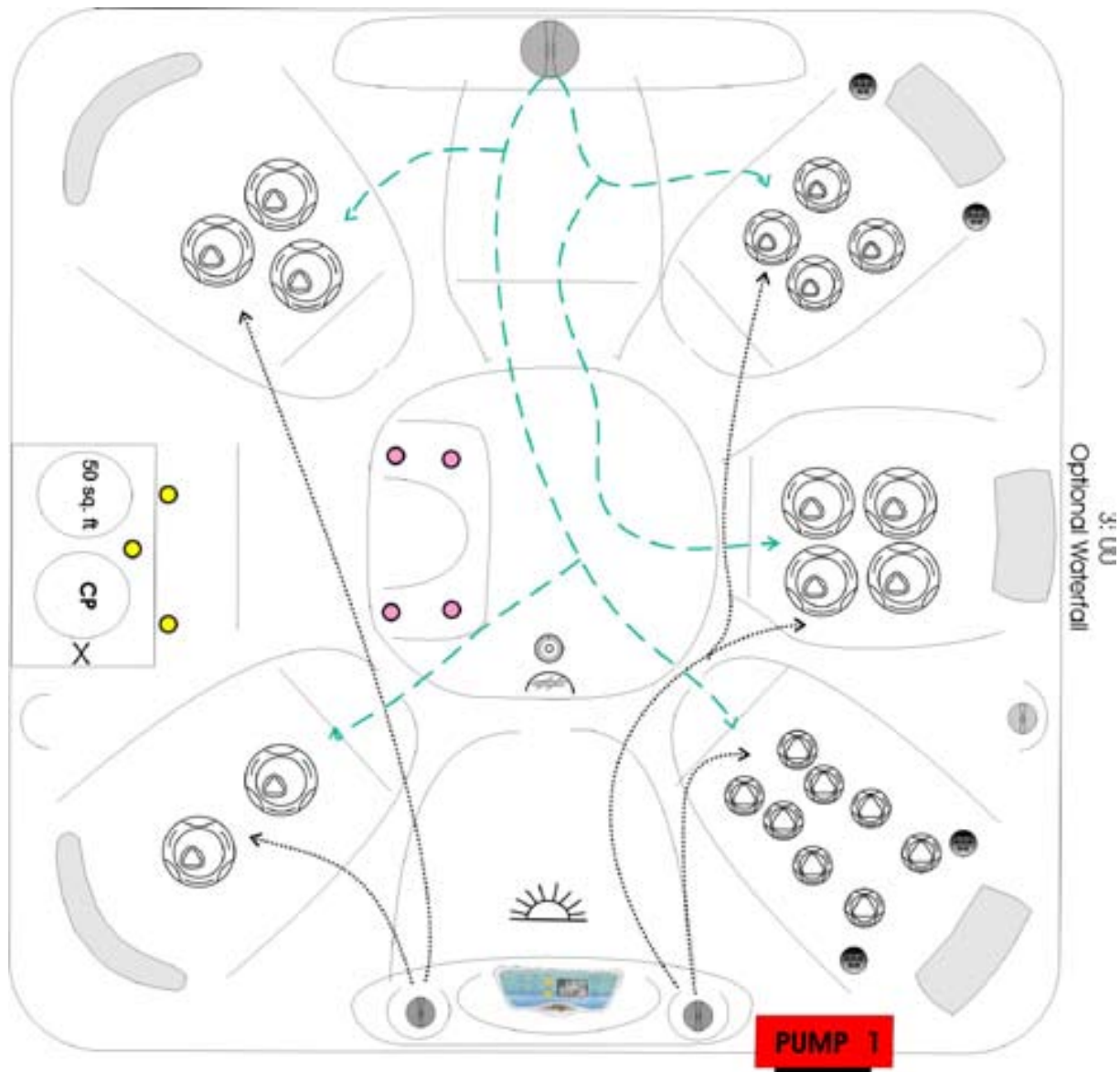

# Captiva 22

	<b>60Hz</b>	<b>50Hz</b>
Volume	350 gal	1324 l
Weight (dry/filled)	550/ 3465lbs	253/1593 kg
Dimensions	82x82x36in	2.08x2.08x0.91 m
Control	MVS504DZ	MGS504SZ
Heater	5.5kW Flo-Thru	2.0kW Flo-Thru
Circulation System	optional	optional
Ozone	optional	optional
Cartridge Filter	2	2

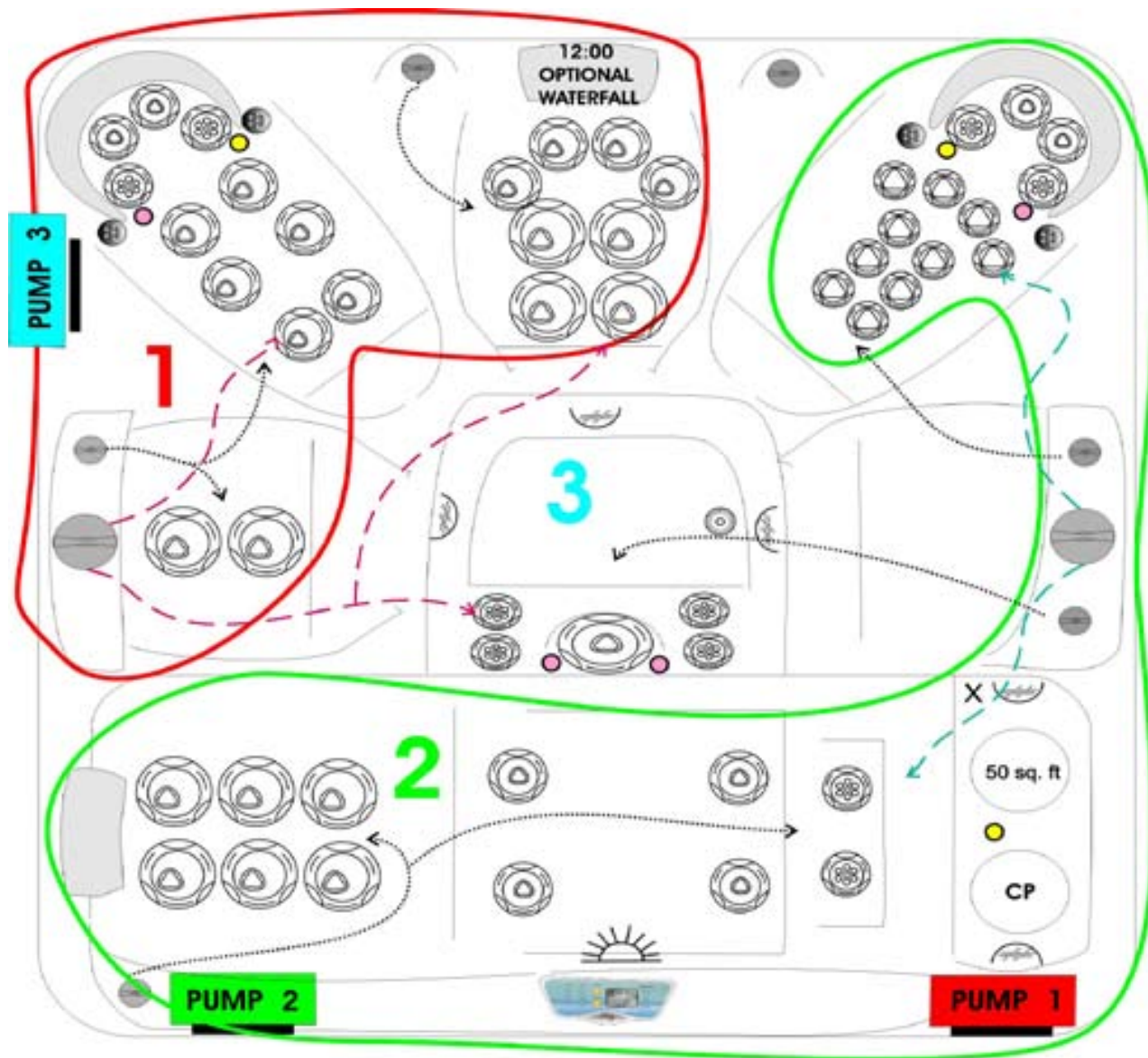

# Antigua 52-3P

	60Hz	50Hz
Volume	325 gal	1230 l
Weight (dry/filled)	550/3257lbs	253/1498 kg
Dimensions	82x82x36in	2.08x2.08x.91 m
Control	MVS504DZ	MGS504SZ
Heater	5.5kW Flo-Thru	2.0kW Flo-Thru
Circulation System	optional	optional
Ozone	optional	optional
Cartridge Filter	2	2

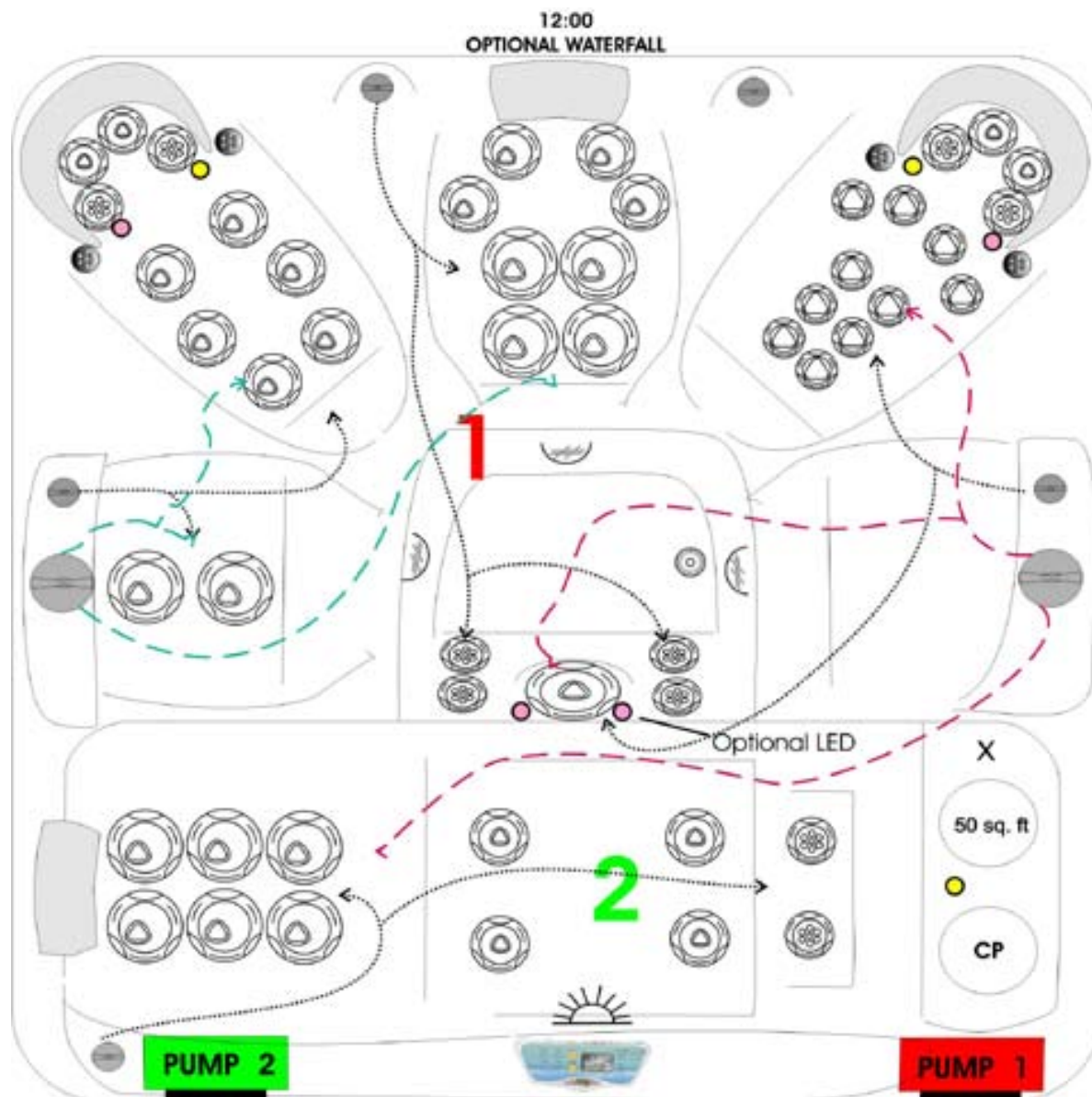

# Antigua 52

	60Hz	50Hz
Volume	325 gal	1230 l
Weight (dry/filled)	550/3257lbs	253/1498 kg
Dimensions	82x82x36in	2.08x2.08x.91 m
Control	MVS504DZ	MGS504SZ
Heater	5.5kW Flo-Thru	2.0kW Flo-Thru
Circulation System	optional	optional
Ozone	optional	optional
Cartridge Filter	2	2

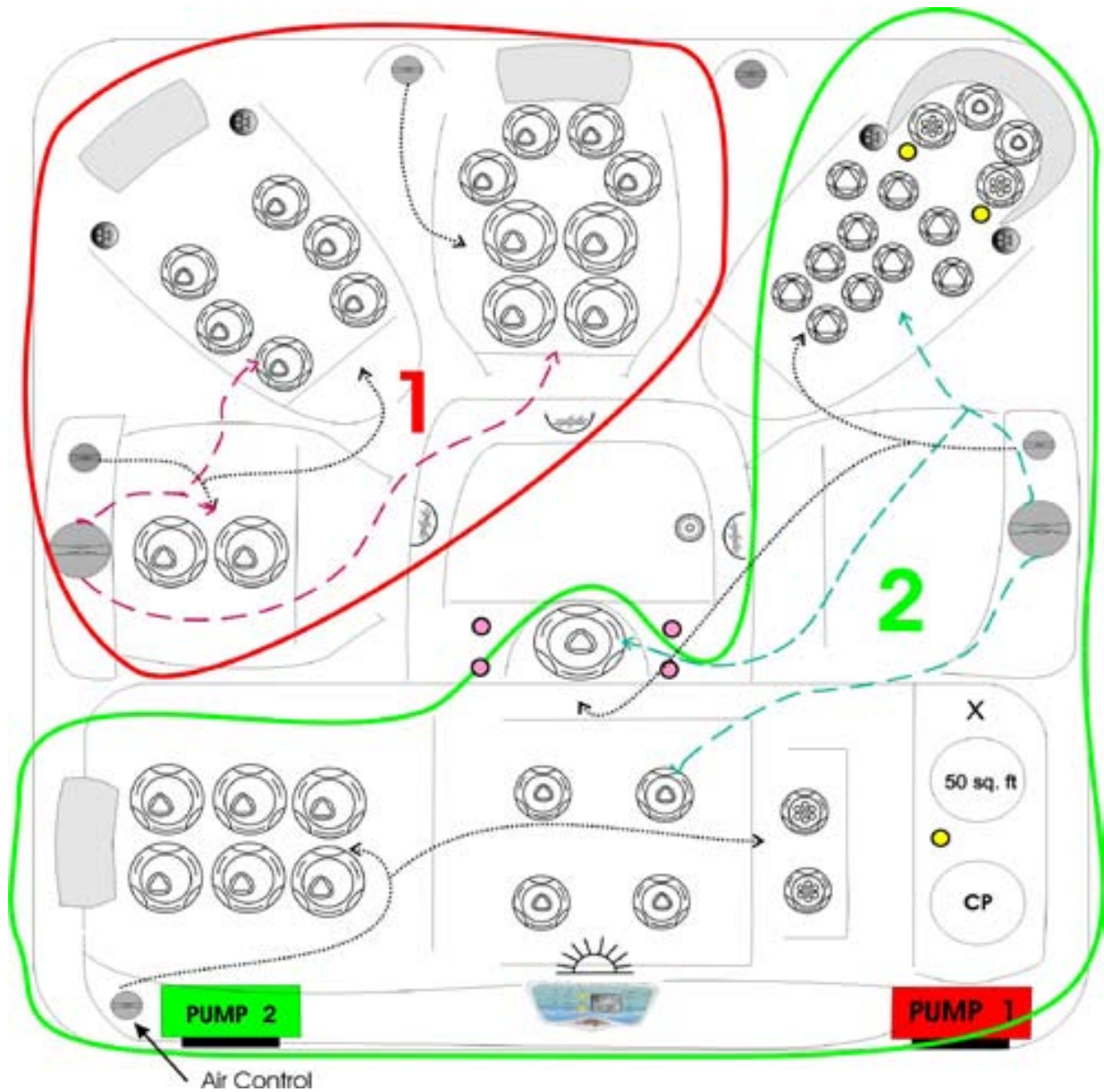

# Antigua 44

	60Hz	50Hz
Volume	325 gal	1230 l
Weight (dry/filled)	550/3257lbs	253/1498 kg
Dimensions	82x82x36in	2.08x2.08x.91 m
Control	MVS504DZ	MGS504SZ
Heater	5.5kW Flo-Thru	2.0kW Flo-Thru
Circulation System	optional	optional
Ozone	optional	optional
Cartridge Filter	2	2

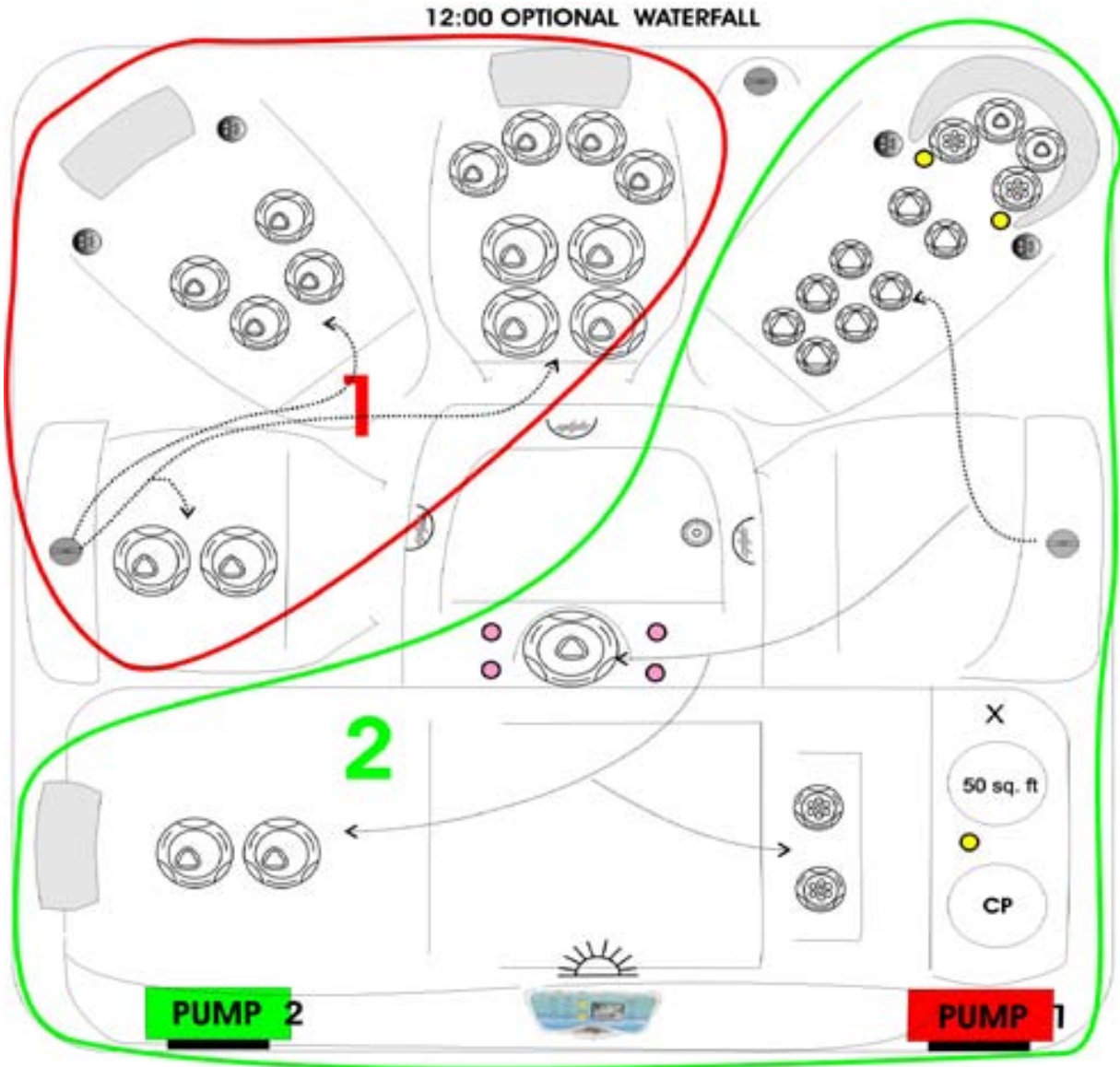

# Antigua 32-2P

	<b>60Hz</b>	<b>50Hz</b>
Volume	325 gal	1230 l
Weight (dry/filled)	550/3257lbs	253/1498 kg
Dimensions	82x82x36in	2.08x2.08x.91 m
Control	MVS504DZ	MGS504SZ
Heater	5.5kW Flo-Thru	2.0kW Flo-Thru
Circulation System	optional	optional
Ozone	optional	optional
Cartridge Filter	2	2

12:00 OPTIONAL WATERFALL

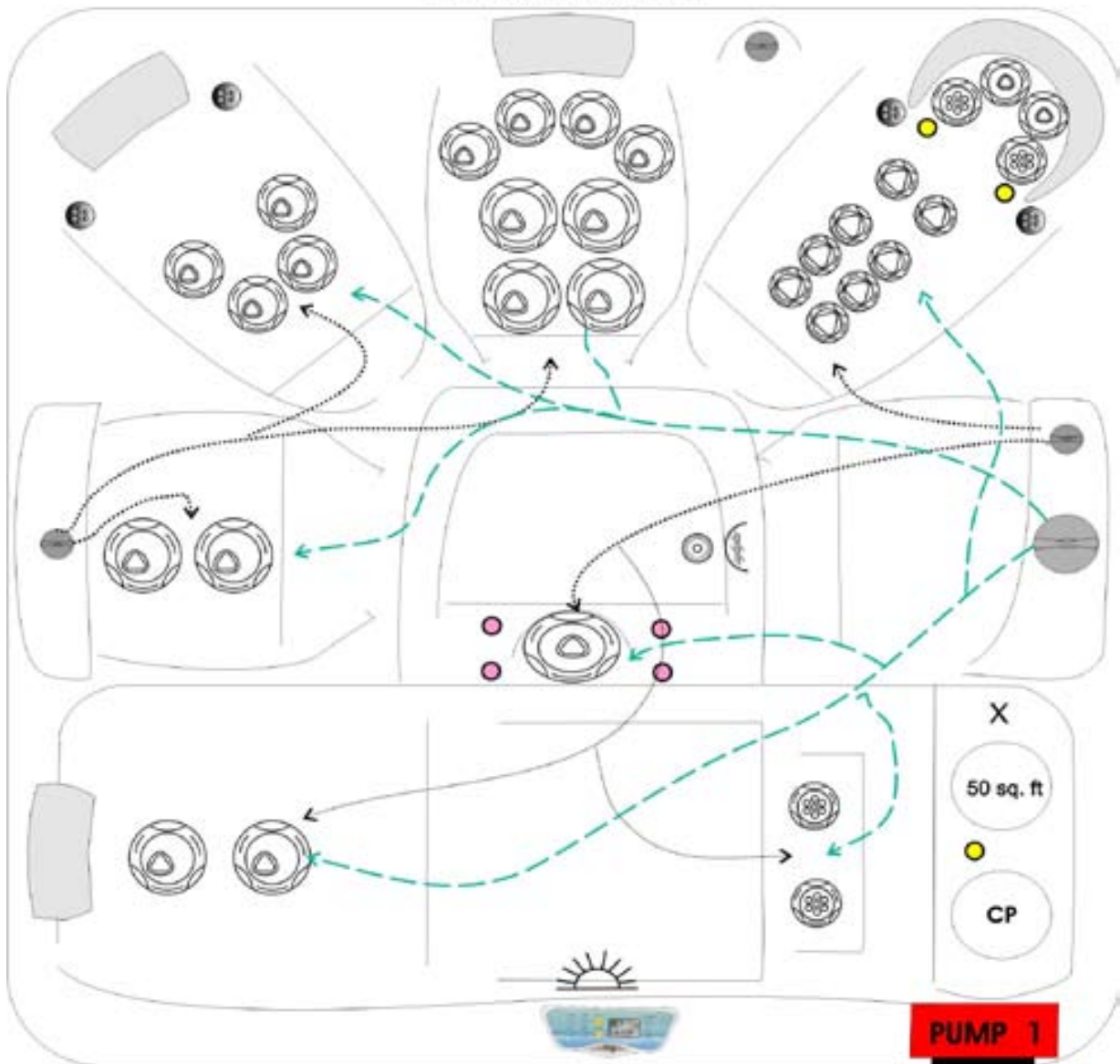

# Antigua 32-1P

	<b>60Hz</b>	<b>50Hz</b>
Volume	325 gal	1230 l
Weight (dry/filled)	550/3257lbs	253/1498 kg
Dimensions	82x82x36in	2.08x2.08x.91 m
Control	MVS504DZ	MGS504SZ
Heater	5.5kW Flo-Thru	2.0kW Flo-Thru
Circulation System	optional	optional
Ozone	optional	optional
Cartridge Filter	2	2

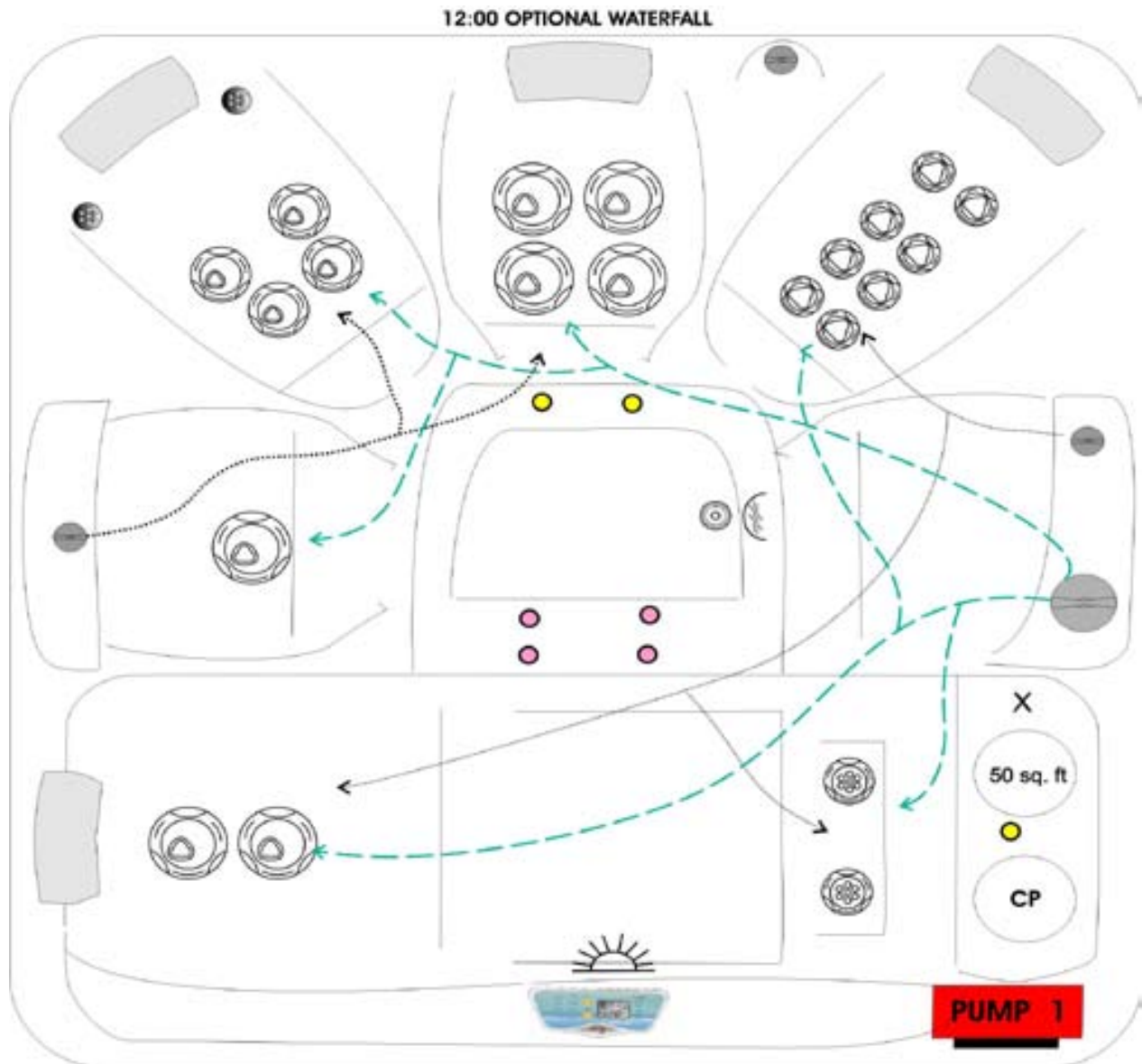

# Antigua 22

	<b>60Hz</b>	<b>50Hz</b>
Volume	325 gal	1230 l
Weight (dry/filled)	550/3257lbs	253/1498 kg
Dimensions	82x82x36in	2.08x2.08x.91 m
Control	MVS504DZ	MGS504SZ
Heater	5.5kW Flo-Thru	2.0kW Flo-Thru
Circulation System	optional	optional
Ozone	optional	optional
Cartridge Filter	2	2

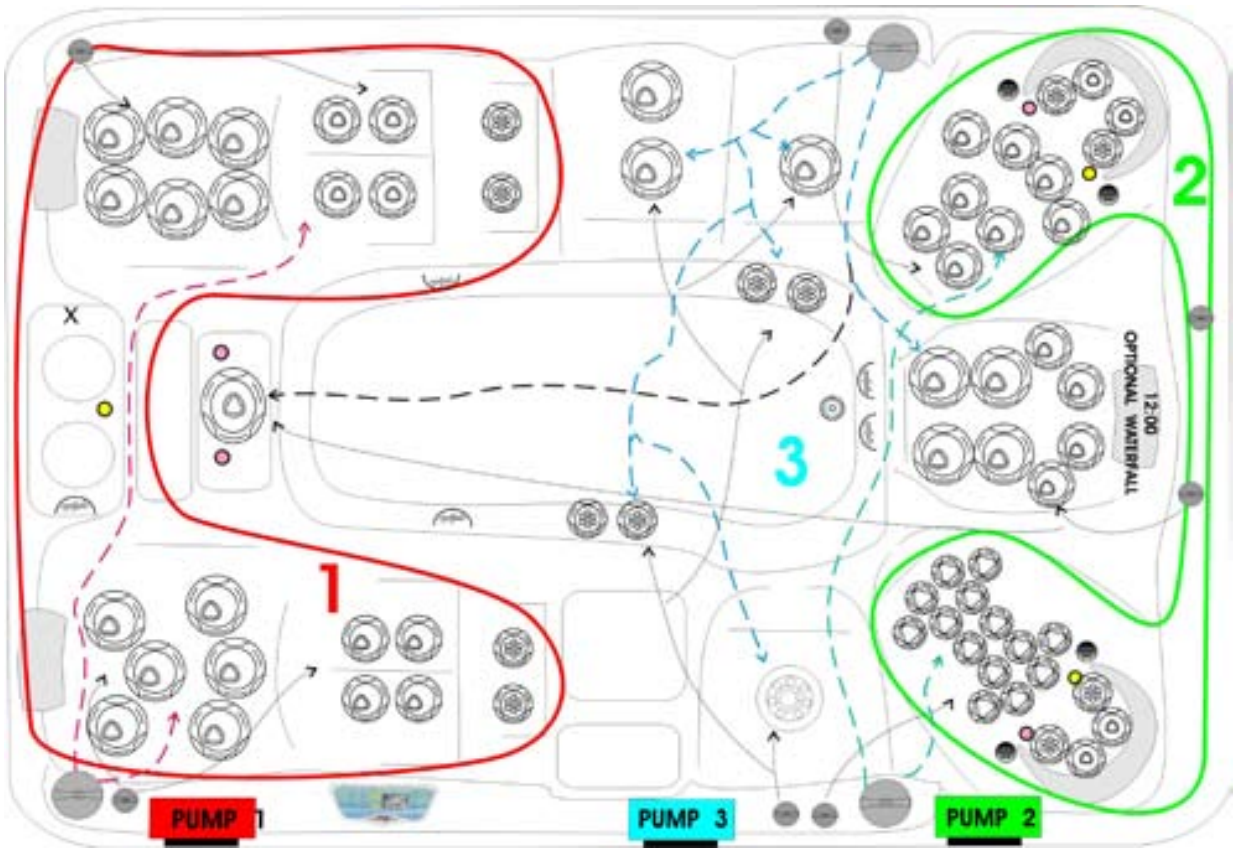

# Bimini 72

	<b>60Hz</b>	<b>50Hz</b>
Volume	580 gal	2195 l
Weight (dry/filled)	1100/5931 lbs	506/2728 kg
Dimensions	91x132x36 in	2.31x3.35x.91 m
Control	MVS504DZ	MGS504SZ
Heater	5.5kW Flo-Thru	2.0kW Flo-Thru
Circulation System	optional	optional
Ozone	optional	optional
Cartridge Filter	2	2

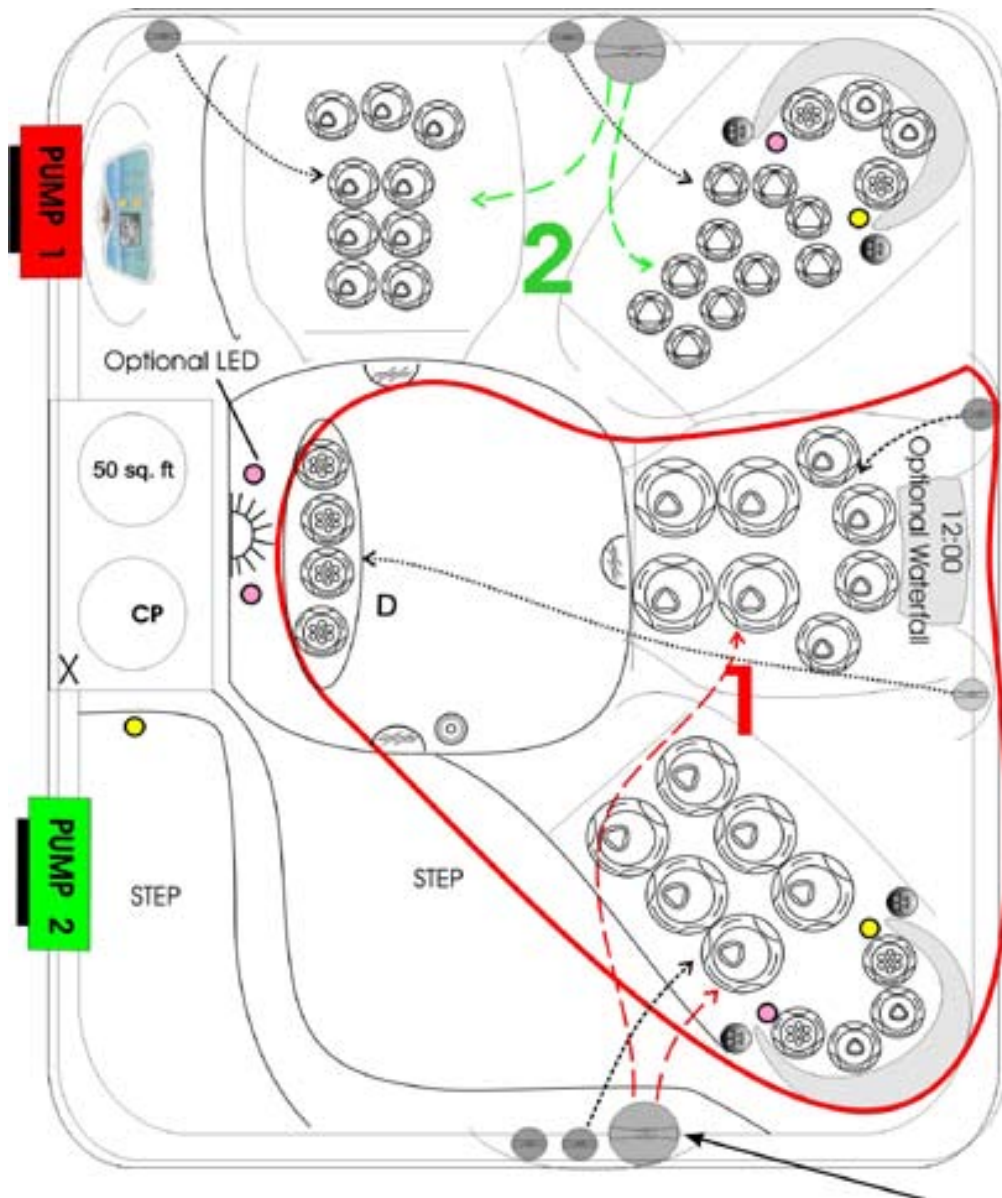

# Saba 46

	<b>60Hz</b>	<b>50Hz</b>
Volume	250 gal	946 l
Weight (dry/filled)	500/2582 lbs	230/1197 kg
Dimensions	72x82x35 in	1.83x2.08x.89 m
Control	MVS504DZ	MGS504SZ
Heater	5.5kw Flo-Thru	2.0kW Flo-Thru
Circulation System	optional	optional
Ozone	optional	optional
Cartridge Filter	2	2

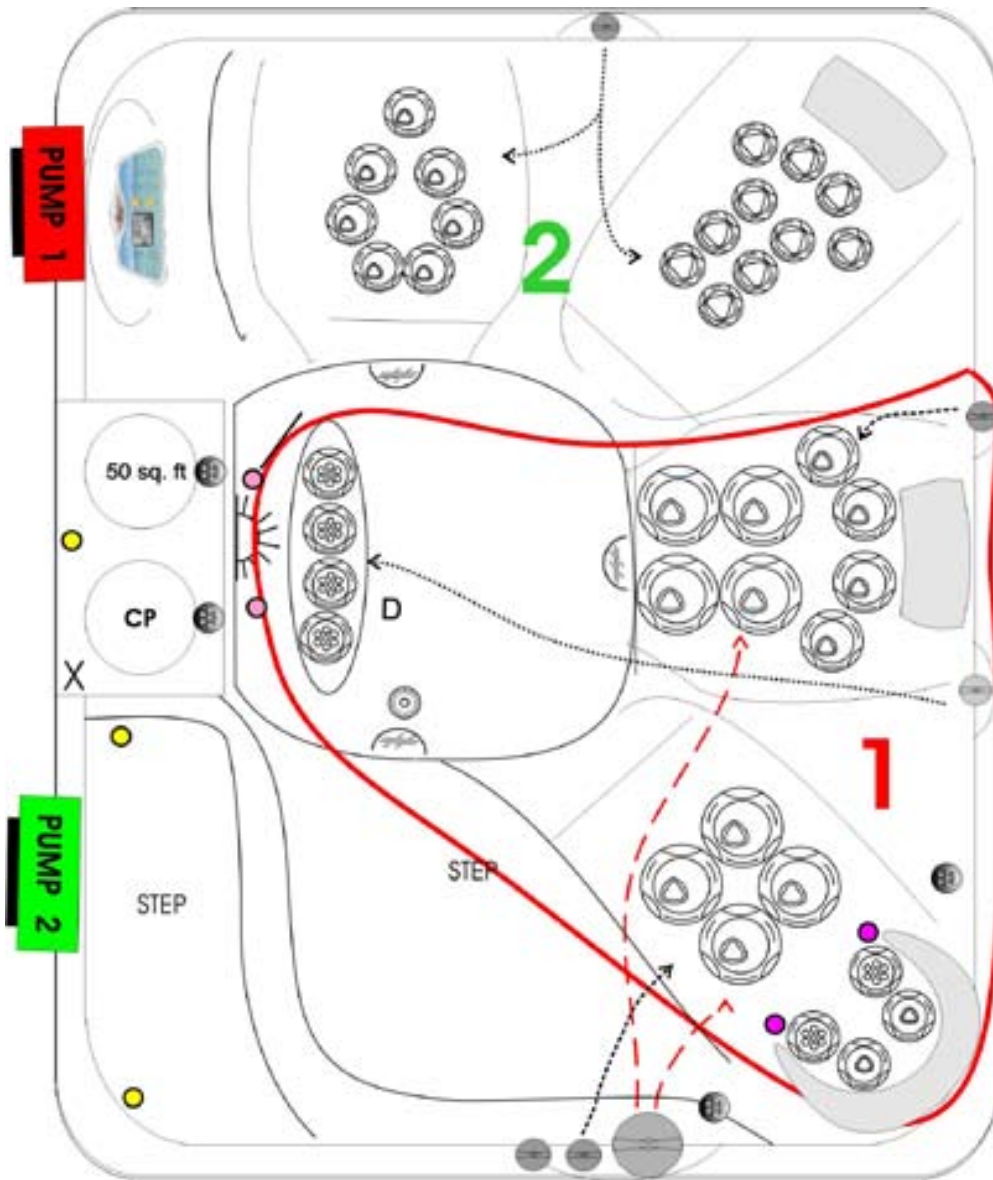

# Saba 38

	<b>60Hz</b>	<b>50Hz</b>
Volume	250 gal	946 l
Weight (dry/filled)	500/2582 lbs	230/1197 kg
Dimensions	72x82x35 in	1.83x2.08x.89 m
Control	MVS504DZ	MGS504SZ
Heater	5.5kw Flo-Thru	2.0kW Flo-Thru
Circulation System	optional	optional
Ozone	optional	optional
Cartridge Filter	2	2

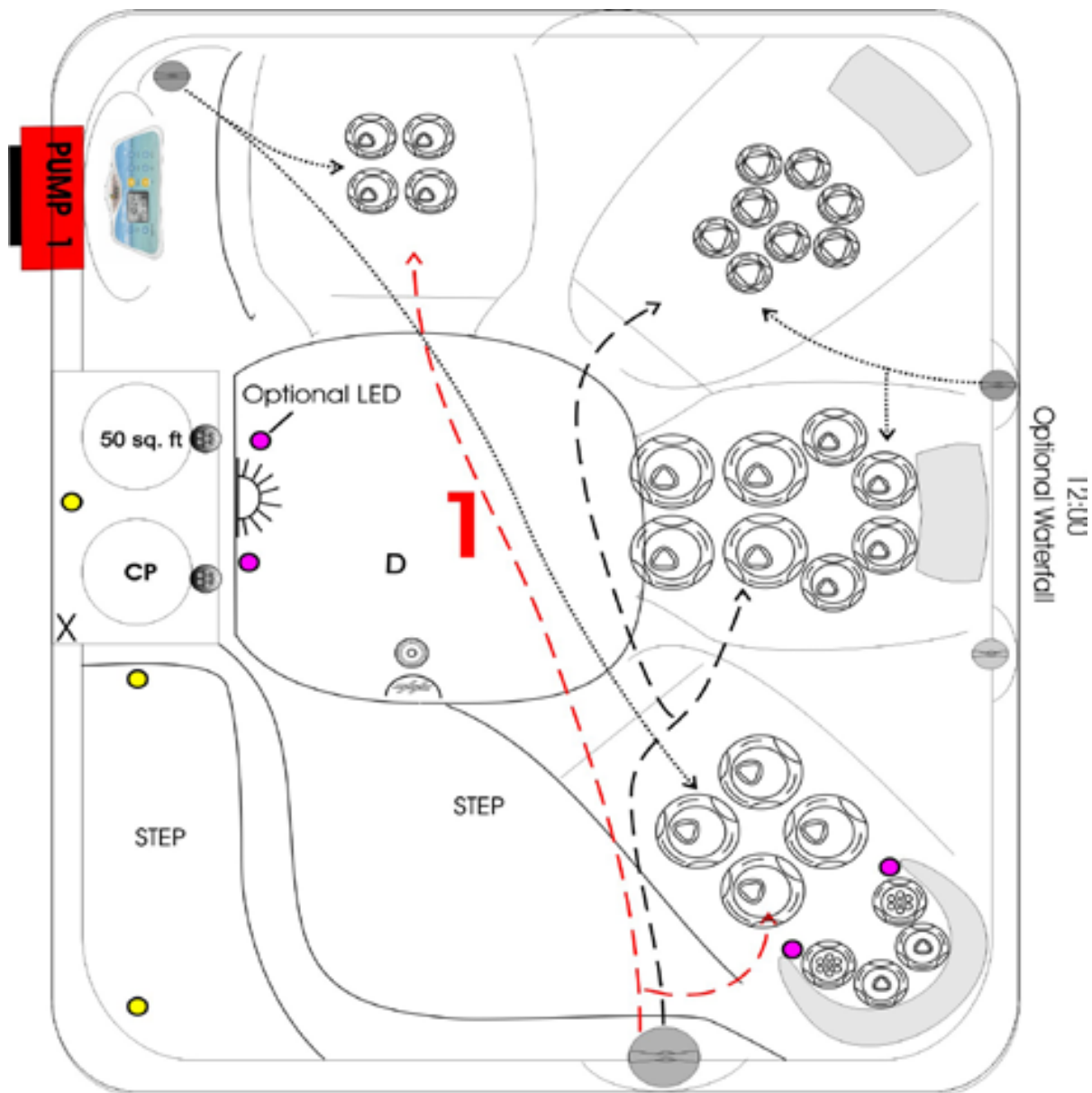

# Saba 29

	<b>60Hz</b>	<b>50Hz</b>
VVolume	250 gal	946 l
Weight (dry/filled)	500/2582 lbs	230/1197 kg
Dimensions	72x82x35 in	1.83x2.08x.89 m
Control	MVS504DZ	MGS504SZ
Heater	5.5kw Flo-Thru	2.0kW Flo-Thru
Circulation System	optional	optional
Ozone	optional	optional
Cartridge Filter	2	2

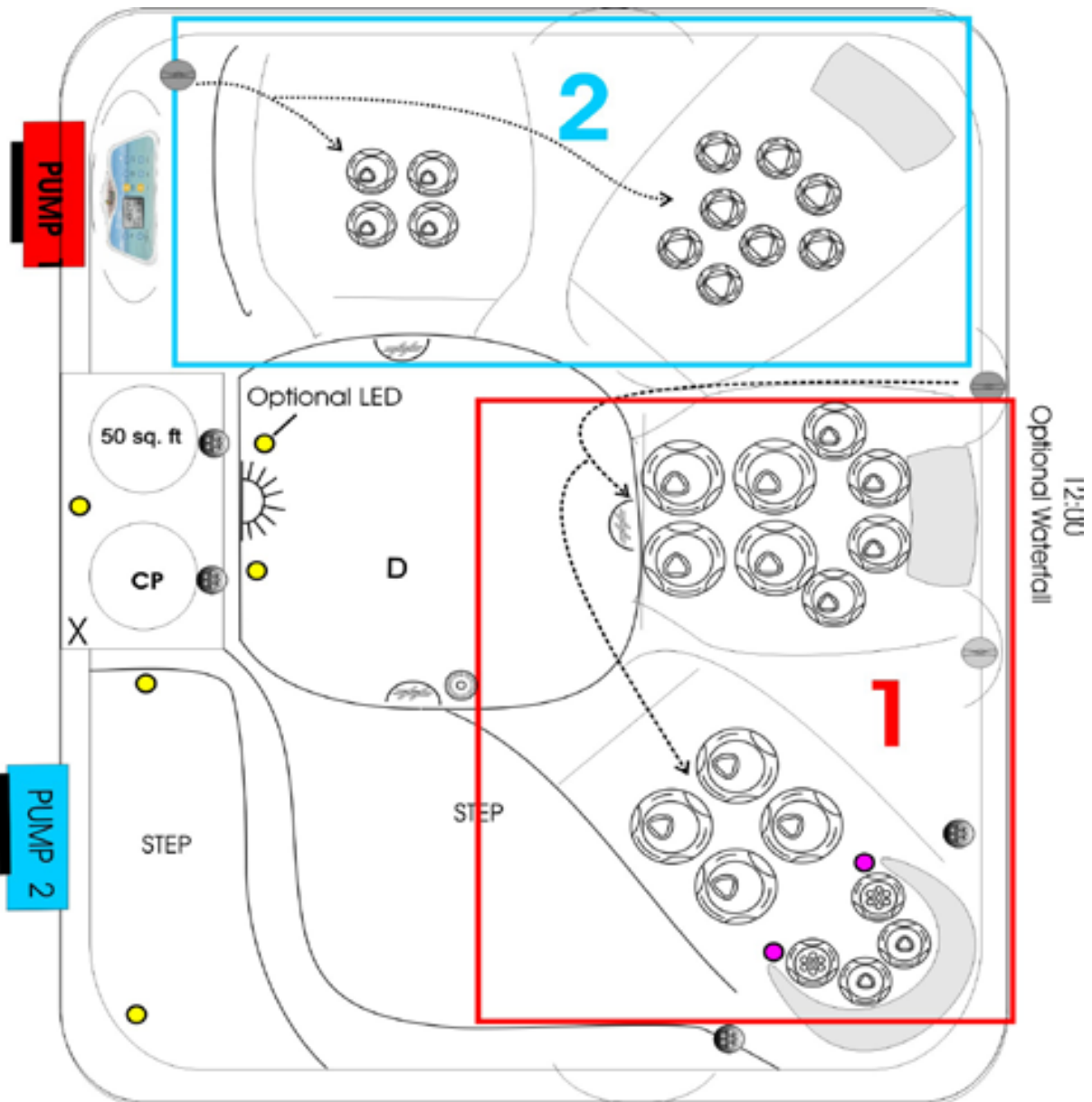

# Saba 29-2P

	<b>60Hz</b>	<b>50Hz</b>
Volume	250 gal	946 l
Weight (dry/filled)	500/2582 lbs	230/1197 kg
Dimensions	72x82x35 in	1.83x2.08x.89 m
Control	MVS504DZ	MGS504SZ
Heater	5.5kw Flo-Thru	2.0kW Flo-Thru
Circulation System	optional	optional
Ozone	optional	optional
Cartridge Filter	2	2

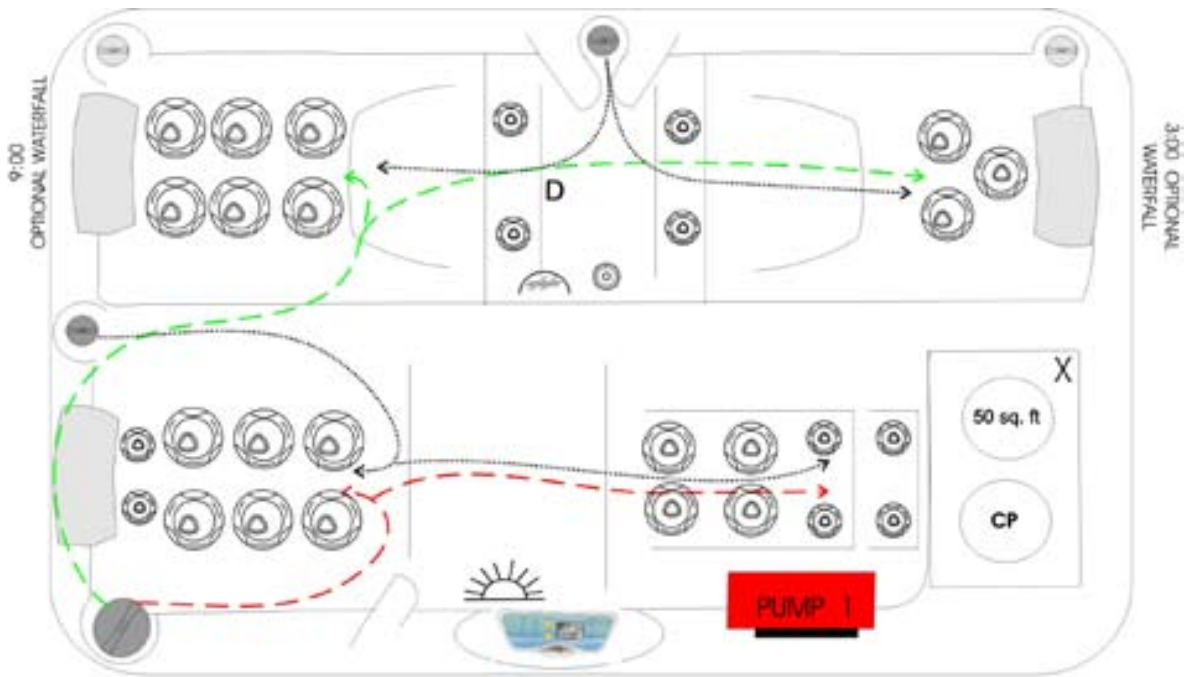

# Santa Cruz 30

	60Hz	50Hz
Volume	180 gal	681 l
Weight (dry/filled)	440/1939 lbs	202/891 kg
Dimensions	82x60x32 in	2.08x1.52x.81 m
Control	MVS504DZ	MGS504SZ
Heater	5.5kw Flo-Thru	2.0kW Flo-Thru
Circulation System	optional	optional
Ozone	optional	optional
Cartridge Filter	2	2

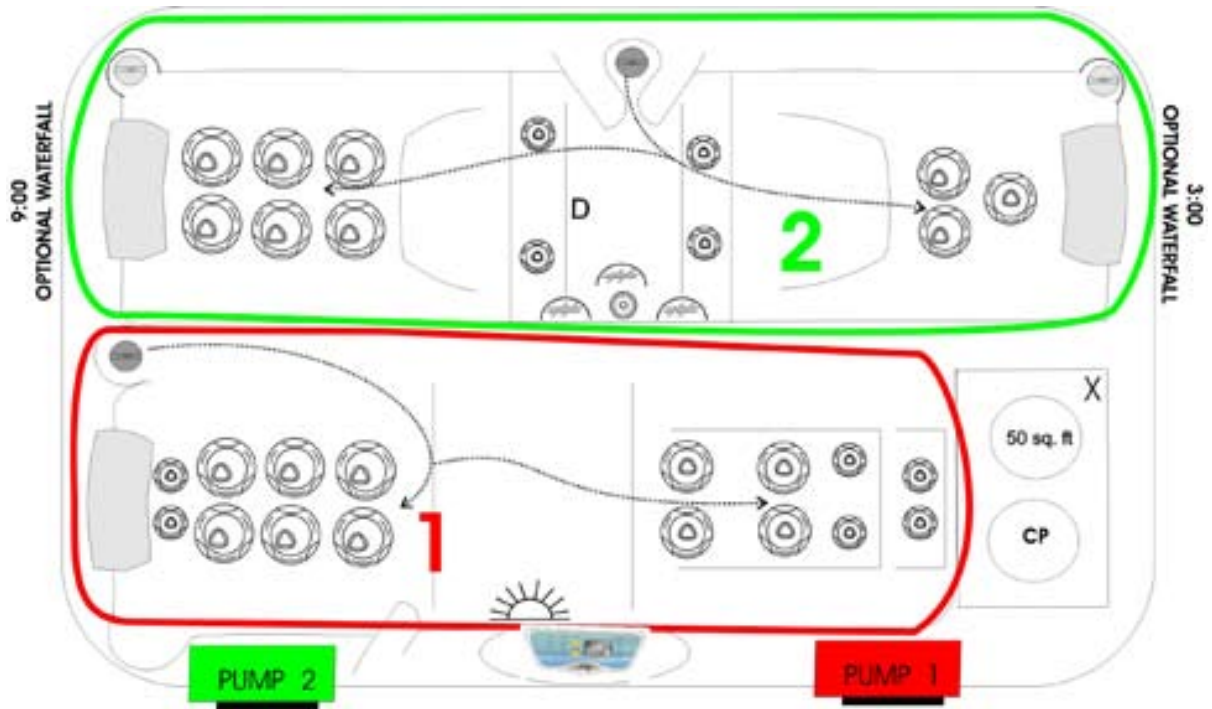

# Santa Cruz 30-2P

	60Hz	50Hz
Volume	180 gal	681 l
Weight (dry/filled)	440/1939 lbs	202/891 kg
Dimensions	82x60x32 in	2.08x1.52x.81 m
Control	MVS504DZ	MGS504SZ
Heater	5.5kw Flo-Thru	2.0kW Flo-Thru
Circulation System	optional	optional
Ozone	optional	optional
Cartridge Filter	2	2

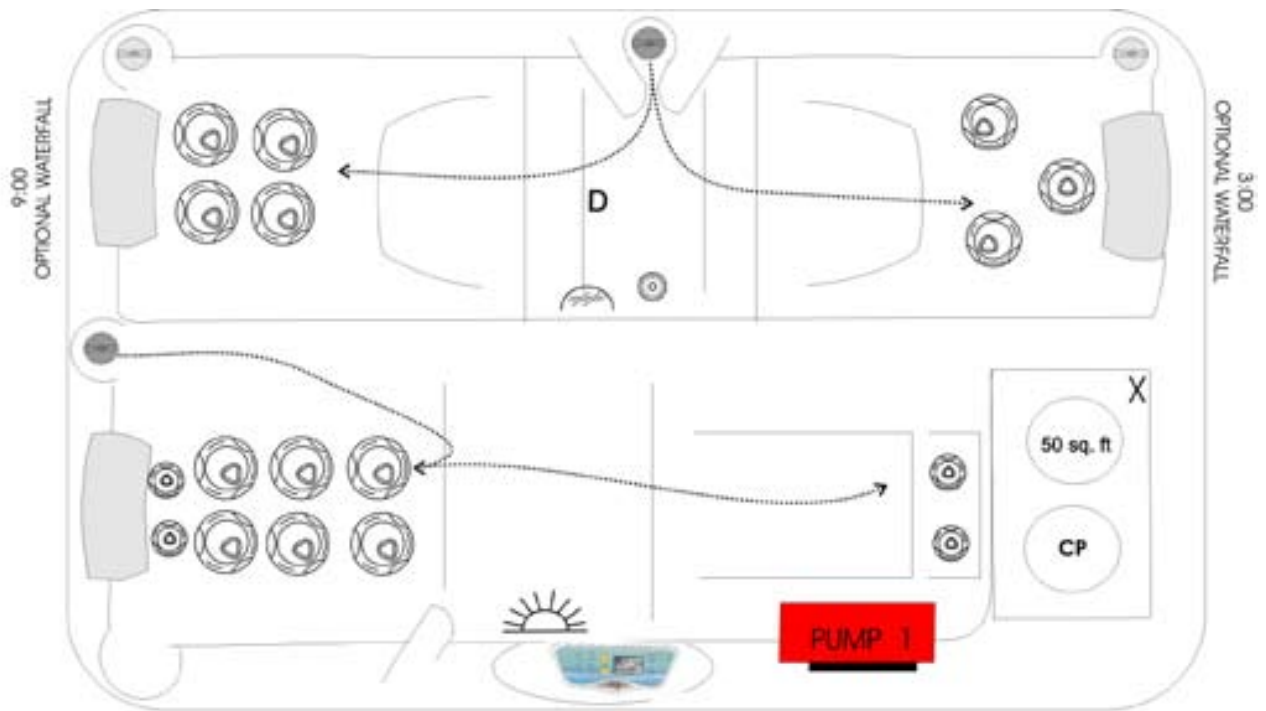

# Santa Cruz 18

	<b>60Hz</b>	<b>50Hz</b>
Volume	180 gal	681 l
Weight (dry/filled)	440/1939 lbs	202/891 kg
Dimensions	82x60x32 in	2.08x1.52x.81 m
Control	MVS504DZ	MGS504SZ
Heater	5.5kw Flo-Thru	2.0kW Flo-Thru
Circulation System	optional	optional
Ozone	optional	optional
Cartridge Filter	2	2

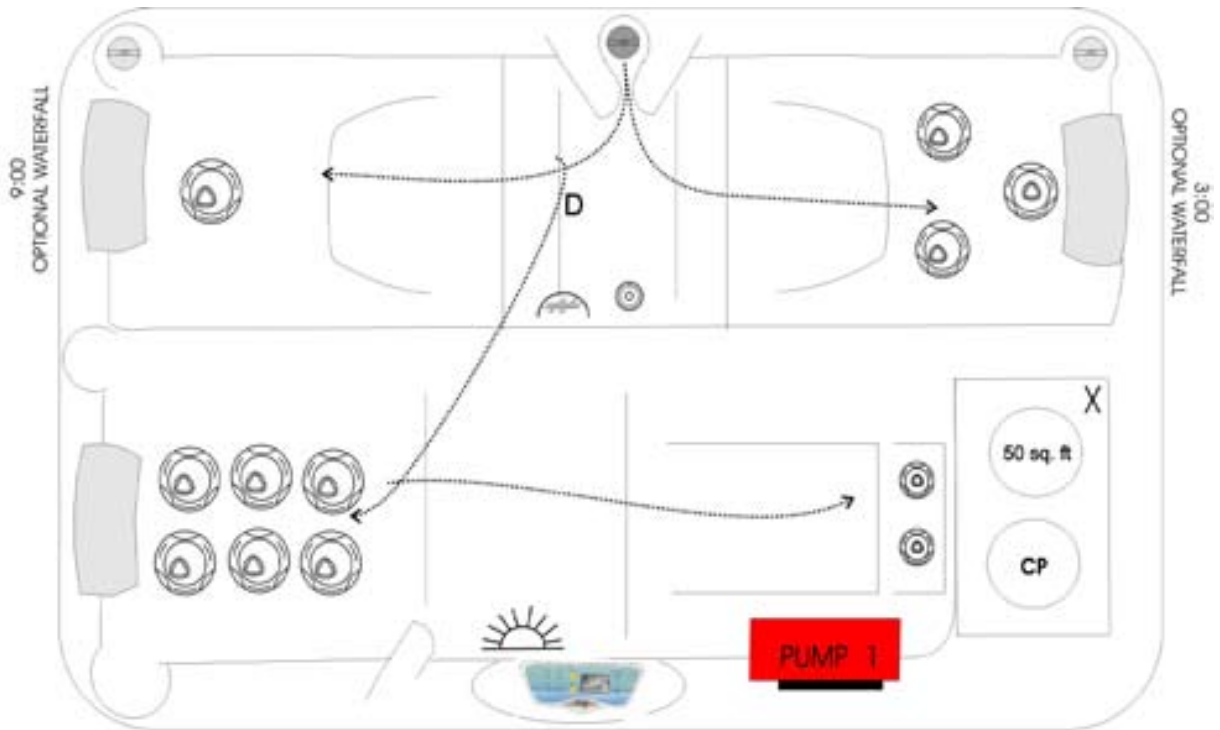

# Santa Cruz 13

	<b>60Hz</b>	<b>50Hz</b>
Volume	180 gal	681 l
Weight (dry/filled)	440/1939 lbs	202/891 kg
Dimensions	82x60x32 in	2.08x1.52x.81 m
Control	MVS504DZ	MGS504SZ
Heater	5.5kw Flo-Thru	2.0kW Flo-Thru
Circulation System	optional	optional
Ozone	optional	optional
Cartridge Filter	2	2

## Pump Configuration for 60Hz

Model Type		Pump 1	Pump 2	Pump 3
Bahama/Cayman	62-3P	6MBPH-2SP 230V	6MBHP-1SP 230V	3MBHP-1SP 230V
	52-3P*			
	52-2P			
	44-2P	4.8MBHP 230V	4.8MBHP-1SP 230V	
	32-1P	6MBHP-2SP 230V		
	32-2P	3MBHP-1SP 230V	3MBHP-3SP 230V	
Antigua/Captiva	52-3P*	6MBHP-2SP 230V	6MBHP-1SP 230V	3MBHP-1SP 230V
	52-2P			
	44-2P			
	32-1P			
	32-2P	3MBHP-1SP 230V	3MBHP-1SP 230V	
	22-1P	4.8HP-2SP 230V		
Santa Cruz	30-1P	6MBHP-2SP 230v		
	30-2P	3MBHP-1SP 230V	3MBHP-1SP 230V	
	18-1P	4.8MBHP-2SP 230V		
	13-1P	3MBHP-2SP 115V		
Saba	46-2P	6MBHP-2SP 230V	6MBHP-1SP 230V	
	38-2P	4.8MBHP-2SP 230V	4.8MBHP-1SP 230V	
	29-1P	6MBHP-2SP 230V		
Bimini	72-3P	6MBHP-2SP 230V	6MBHP-1SP 230V	4.8MBHP-1SP 230V

**Note: (\*) On all 52jet, 3 pump configurations 4.8hp pumps will be used**

## Pump Configuration for 50Hz

Model Type		Pump 1	Pump 2	Pump 3
Bahama/Cayman	62-3P	2HP-2SP 230V	3HP-1SP 230V	1.4HP-1SP 230V
	52-3P*			
	52-2P			
	44-2P	1.4HP-1SP 230V	1.4HP-1SP 230V	
	32-2P			
	32-1			
Antigua/Captiva	52-3P	2HP-2SP 230V	3HP-1SP 230V	1.4HP-1SP 230V
	52-2P			
	44-2P			
	32-2P	1.4HP-1SP 230V	1.4HP-1SP 230V	
	32-1P	2HP-2SP 230V		
	22-1P	2HP-2SP 230V		
Santa Cruz	30-2P	1.4HP-1SP 230v	1.4HP-1SP 230V	
	30-1P	2HP-2SP 230V		
	18-1P			
	13-1P			
Saba	46-2P	2HP-2SP 230V	3HP-1SP 230V	
	38-2P			
	29-1P			
Bimini	72-3P	2HP-2SP 230V	3HP-1SP 230V	1.4HP-1SP 230V

**Note: (\*) On all 52jet, 3 pump configurations 4.8hp pumps will be used**

# ELECTRICAL REQUIREMENTS AND INSTALLATION

---

The following information is provided for hooking up electrical supply to your new spa. A qualified, licensed, electrician must perform this work. Failure to follow these instructions will terminate all warranty coverage and can cause serious injury or death.

Your 60Hz Artesian spa is preset at the factory to run on 240V with a 48 amp maximum input. This feature gives you the most performance out of your spa. This will require a 240V, 60-amp GFCI. If a 60-amp service is not available, please contact the Artesian Spas' Customer Service department to configure the amp draw requirements.

## ELECTRICAL WIRING

---

**WARNING: Your spa must be wired by a certified electrician and according to these instructions. Failure to do so will terminate all warranties and all listings from the independent listing facility.**

- 1) The Island Class Spa requires a 240 VAC dedicated system. The spa must be hardwired to the power supply, with no plug-in connections, extension cords, or sharing of service.
- 2) The spa requires that you run 6 or 8 AWG copper wire, depending on the GFCI size. Do Not Use Aluminum Wire.
- 3) The power supply must have a suitable Ground Fault Circuit Interrupter (GFCI), according to Section 422-20 of the National Electrical Code, ANSI/NFPA 70-7987. This could be used as the shut-off switch, which must be installed in plain view of the spa. This electrical service must be readily accessible to the spa occupants, but must not be within 5 feet of the spa.
- 4) Use only non-metallic conduit and fittings when installing power to the spa.
- 5) After your spa has been positioned, route lines through the knockout on the left or right front corner of the spa.
- 6) Connect the power to the spa.

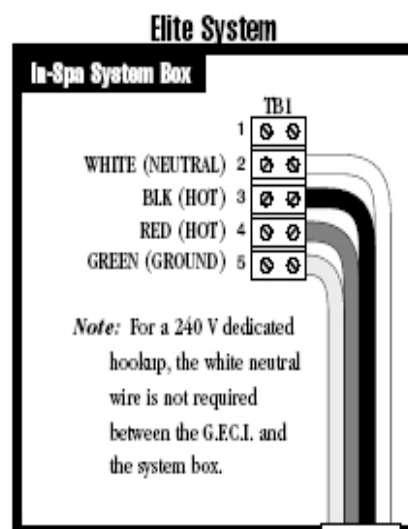
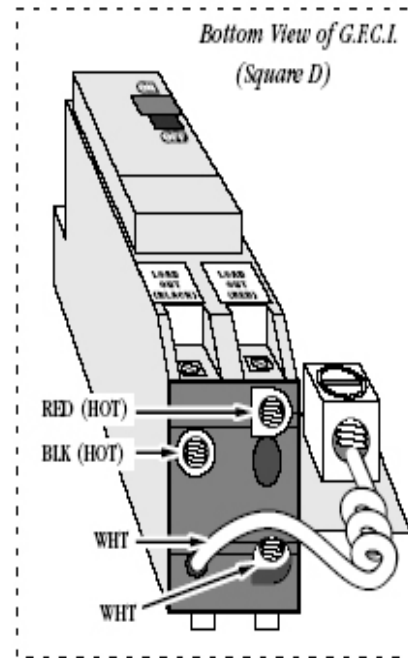
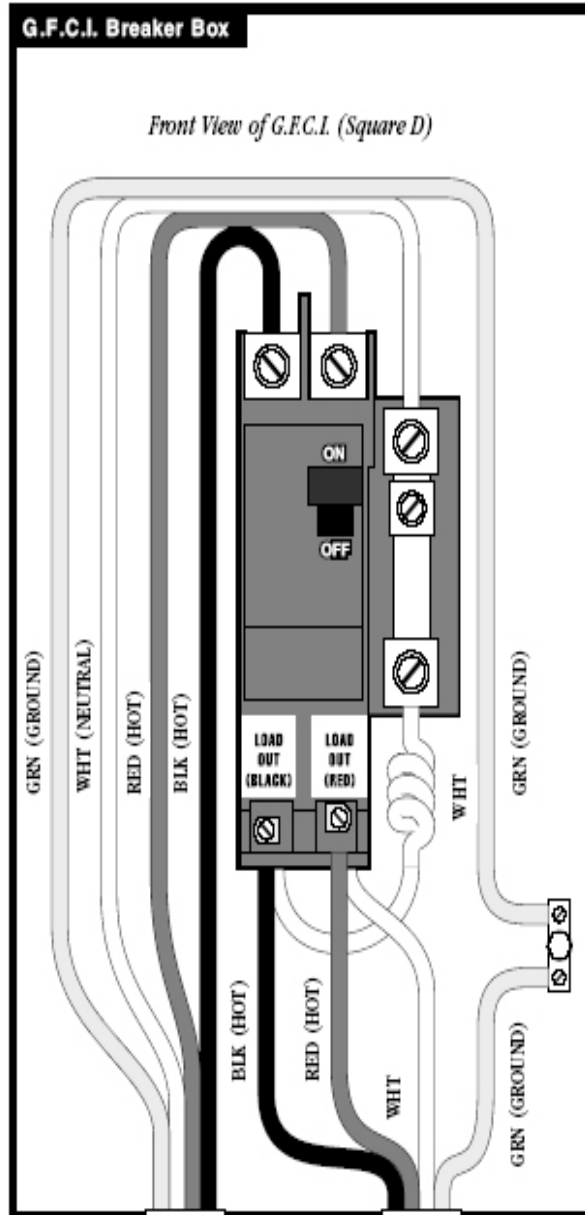
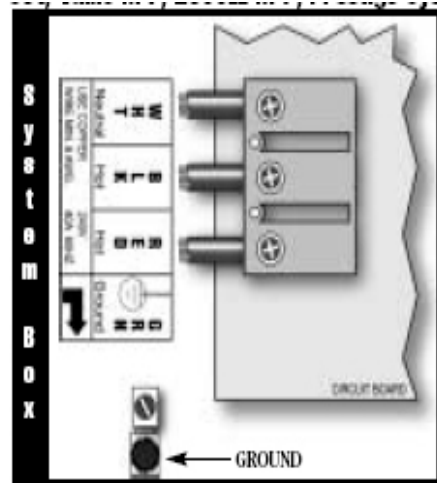
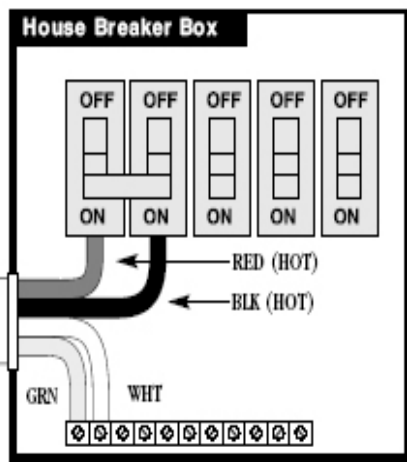

# 50 Hz Electrical Installation

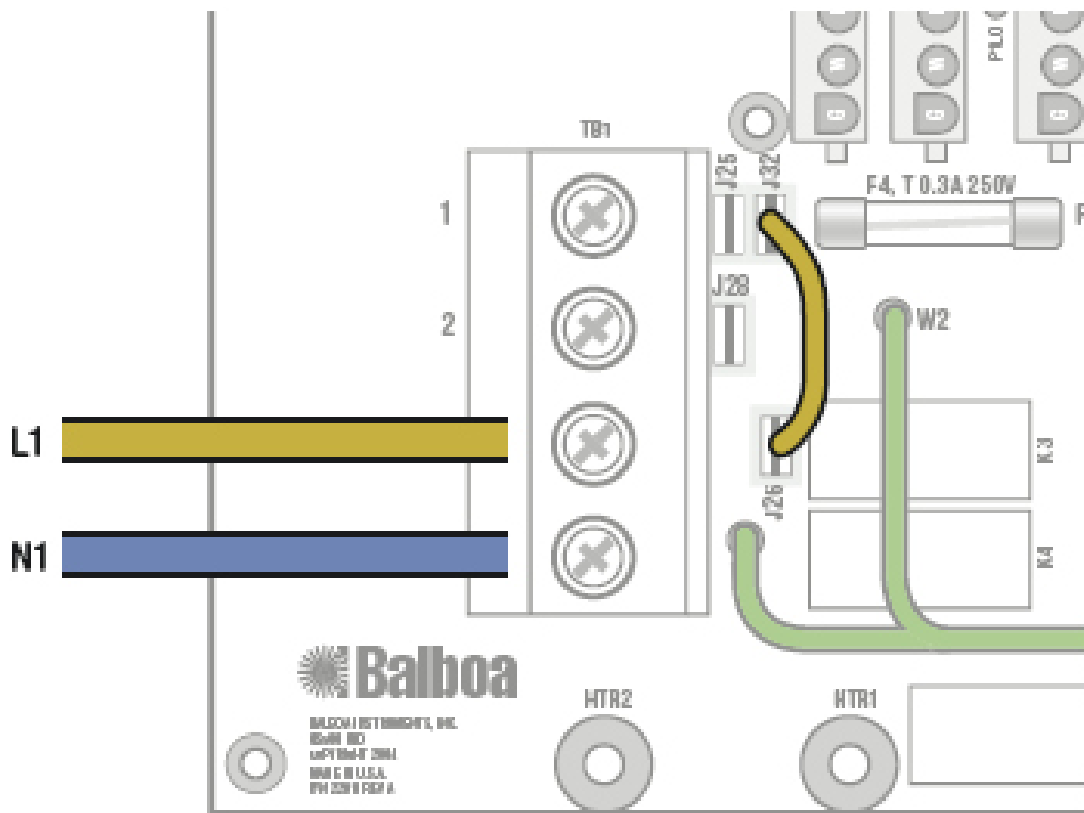

Single Service: (1 X 16 Amps or 1 X 32 Amps) This option is configured and shipped as the default.

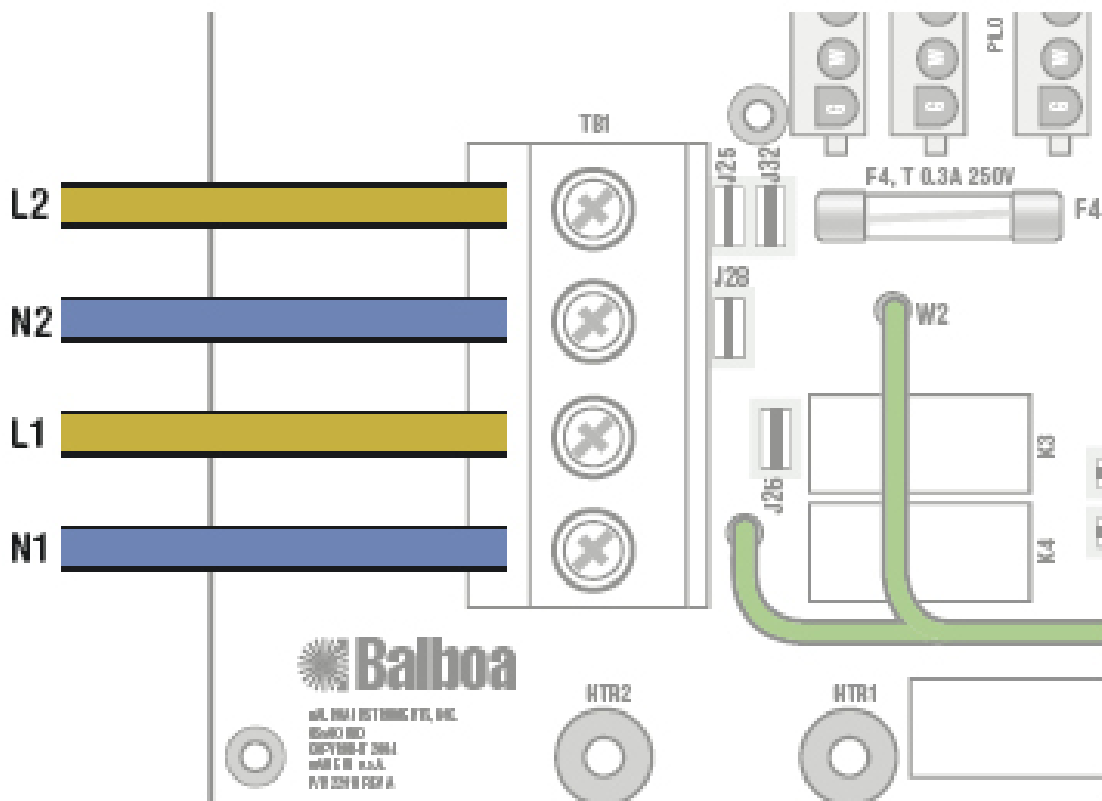

Dual service: (2X 16 Amps) Completely remove the white wire from J32 and J26

## Picture of System Box Terminal Connection for 60Hz

---

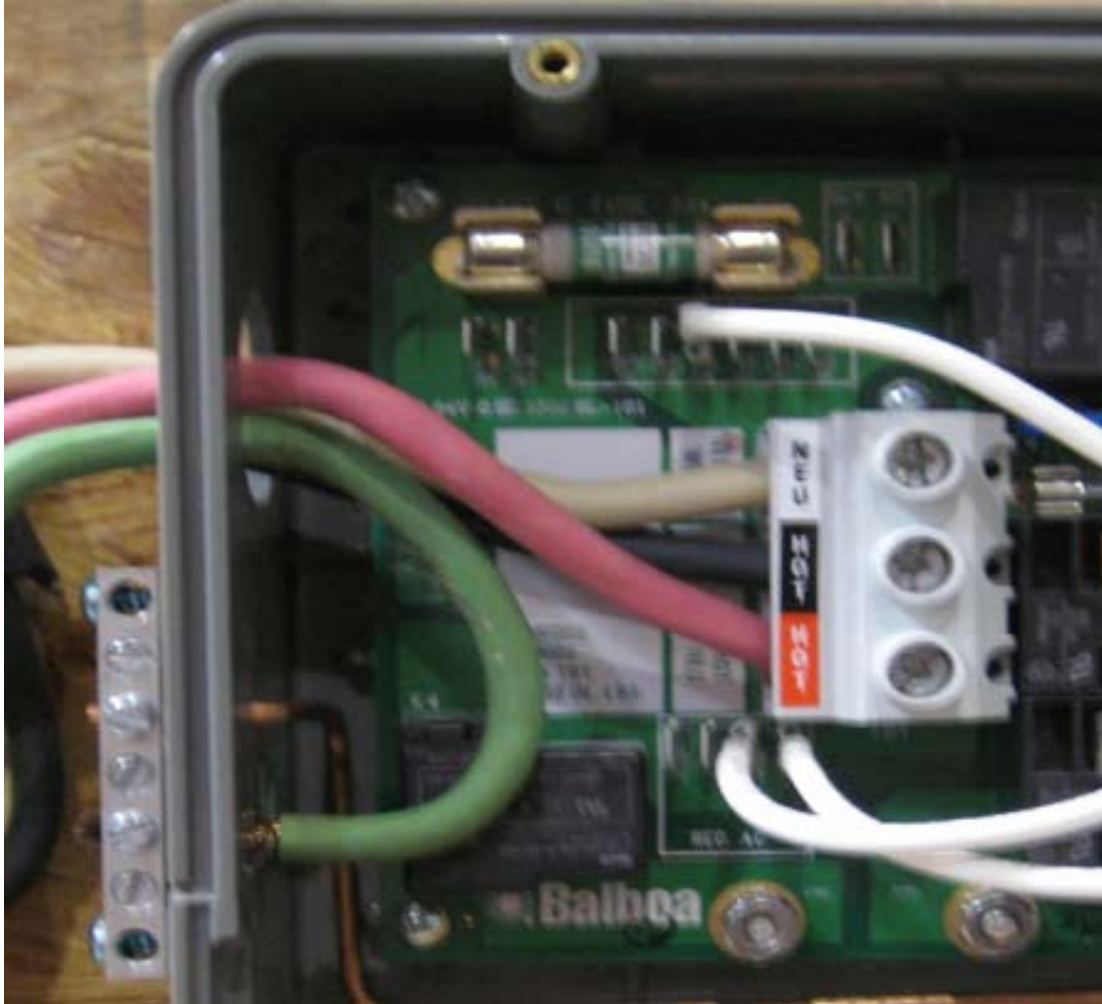

Connect the each color to its respective terminal block location. The Ground (green) wire must be connected to the grounding terminal which is outside of the System box. The Grounding wire must first enter the system box and then access the grounding terminal via a hole on the side of the box adjacent to the grounding terminal as shown in the picture above.

## PROCEDURE FOR 120VAC CONVERSION

---

Verify that the required equipment attached to the VS Series spa control is rated for 120VAC

When using 120VAC service, the effective heater output will be 25% of the 240VAC rating.

Example: A 5.5kW @240VAC heater becomes approximately 1.25kW@120VAC

1. Verify that power is disconnected prior to performing any work on the system.
2. Add jumper wire (14AWG minimum) from White AC voltrex (typically J11) to Red AC voltrex (typically J32). Most systems will have this wire included in a plastic pouch on the back of the enclosure.
3. Adjust DIP switches to “Low Amperage” mode.
  - a. Some systems use DIP A10 only. Set this DIP switch in the “ON” position.
  - b. Some systems use multiple DIP switches to control amperage. Refer to product Hot Sheet and set number of pumps with heat to “0” accordingly
4. Connect Line wire from AC service to “HOT BLACK” terminal to TB1.
5. Connect Neutral wire from AC service to “NEUTRAL WHITE” terminal of TB1. Spa will now operate using 120VAC service.
6. There should be NO Line 2 of Red conductor attached to TB1 when the system is running in 120VAC mode.

# Power Terminals Diagram for 120VAC setup

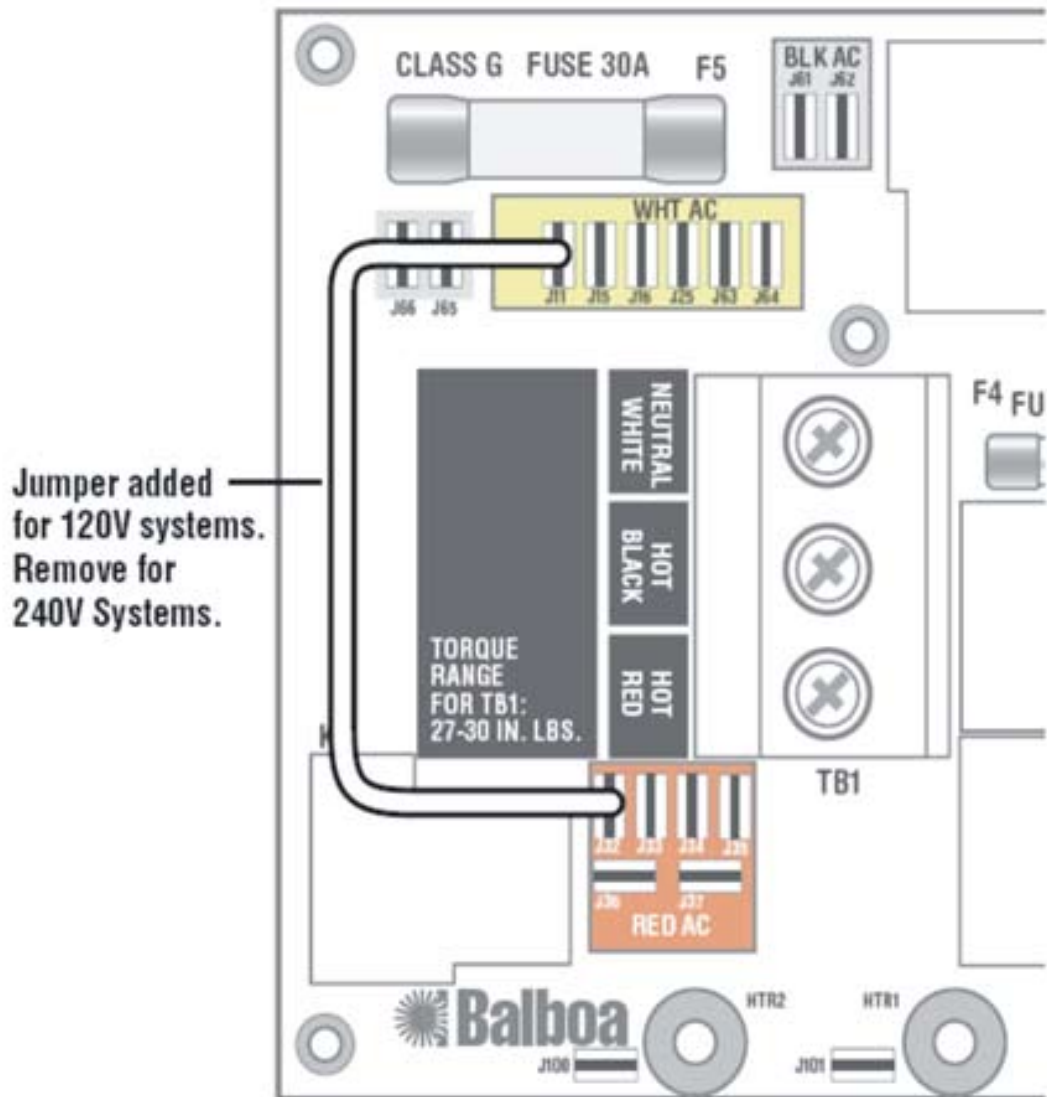

# **SPA START-UP**

---

Please read each step of the Start-up section prior to doing the step.

## **SELECTING A LOCATION**

---

In preparation for installing your new Artesian spa, you should ensure that your chosen location meets some minimum guidelines:

- 1) Place your spa on a surface that is large enough for the entire spa to fit. Consider the space needed to easily access equipment compartments and circuit breakers. Remember, all electronics must be kept dry.
- 2) The spa must be on a solid, level foundation. Recommended: 4-inch cement slab that has cured for at least 72 hours. Your warranty will be voided if the spa is not properly installed. Structural damage due to an improper foundation is not covered under warranty.
- 3) To avoid potential water damage to the skirt and frame, your spa should be placed on a site where it will not be in the way of water sprinklers.
- 4) **OUTDOOR SPAS:** Consider building codes, electrical and plumbing codes, desired proximity to house, wind and sun exposure, location of trees (falling leaves, shade), dressing area, landscaping and lighting when selecting a location.
- 5) **INDOOR SPAS:** Floor surface must have traction to prevent slipping when wet. A floor drain is optimum. As room humidity will increase because of the spa, provide ample ventilation to prevent dry rot, mildew and mold. Use materials that will withstand humidity. There may be a need for cross-ventilation fans and/or dehumidifiers. The spa chemicals may corrode some household metals. Provide ample room if servicing should be needed. Strong foundational support is vital, particularly if a second-story site is selected.
- 6) Ensure the equipment compartment is in a location where it will not be damaged by water drainage. Cover the equipment compartment with a heavy screen if rodents are a problem. Damage due to rodents is not covered under warranty.

7) Have the spa deck installed by a knowledgeable contractor to ensure proper support.

8). If the spa is placed on the ground, even for a short period of time, it must be supported by stones that are at least 2 inches thick and 12 inches square. A solid foundation is recommended as soon as possible.

## **INSPECTION**

---

You will want to inspect your spa, prior to filling it up with water. Look for and remove any debris in the spa tub and in the filter. Verify that pump plugs are installed on the pumps and the pump unions are tight.

## **FILLING THE SPA WITH WATER**

---

**NOTE: DO NOT fill your spa with hot water straight out of your water heater or tap. This water may be as hot as 180 degrees F and will cause damage to the surface and plumbing of the spa. This will void your warranty. Level the spa before filling.**

- 1) Prepare to fill the tub by removing all debris.
- 2) Remove the filters from your spa (see Removing, Installing and Cleaning Filters, page 28)
- 3) Insert the hose in the area where the filter was located as shown in the picture below.



## **SPA START-UP cont...**

---

### **FILLING THE SPA WITH WATER cont...**

---

4) Fill the spa to the bottom of the pillows.

**Note: DO NOT OVER-FILL YOUR TUB!**

5) With the front panel off, verify there are no leaks at the pump union.

**Note: Pump unions can become loose during shipping. Verify that there are no leaks during filling of the spa.**

6) Replace both filters.

### **TURNING THE POWER ON**

Turn the power to the spa on at the main circuit breaker. Verify that your spa has no error codes. (See page 12) Verify that there is good water circulation in the spa. The pump will initially come on for 5 minutes and cycle through each pump for one minute on each pump at start up.

### **VERIFYING WATER CIRCULATION**

1) Open all the jets.

2) Press the Jets 1/2/3 button to turn the pumps on or off.

3) Make sure each seat has water flow.

## **TESTING THE GFCI BREAKER**

---

**NOTE: The electrical service panel for your spa should be equipped with a GFCI breaker. To avoid the risk of electrical shock, perform the following safety test before each use of your spa.**

- 1) Make sure the power is turned on at the electrical service panel.
- 2) Turn on the GFCI breaker. If the breaker stays on, it is functioning properly.

### **DANGER: RISK OF ELECTRICAL SHOCK**

If the GFCI breaker fails to operate as described, there is a possibility of an electric shock if the spa is used. Shut off the power at the main electrical service panel until the source of the problem has been identified and corrected by a licensed electrician or qualified spa technician.

# SPA START-UP cont...

---

Turning on the Spa for the first time.

---

**NOTE:** When power is turned on, your spa will automatically start out in priming mode for approximately 2 minutes indicated by “Pr” on the topside control. During this time no components are powered. At the end of the two minute period the low speed pump will be activated for 30 seconds followed by all of the pumps being activated on high speed for another 30 seconds. Once the high speed pump(s) have turned off a temperature reading will be taken. This takes about 2 minutes for the heater to correctly display a temperature reading to the topside control.

Adjust your temperature by pressing the “Warm” or “Cool” button on your touchpad until the desired temperature is displayed. This setting will allow your spa to heat to the set temperature.

**CAUTION:** *If water is not noticeably coming from your spa jets during the automatic purge, turn on the high speed pump. If water is still not coming from the jets, the pump needs to be manually primed, following the steps below.*

## PRIMING THE PUMP

---

- 1) Turn off power at electrical service panel.
- 2) Locate and loosen the pump by turning it counterclockwise one half of one turn.
- 3) Allow air to escape from the fitting. When a steady stream of water flows from the pump plug, close it by turning it clockwise until tight.
- 4) Turn on power at electrical service panel.
- 5) Check once more to make sure that water is flowing from the jets during auto purge. If so, continue. If no water is coming from your spa jets, please call your Artesian dealer for further assistance.

## WATER PREPARATION

---

**NOTE:** Before putting your new spa into operation, understand that preparing your new water is an important part of maintenance. Failure to properly prepare your water can result in substantially decreasing the life of the components and may void your warranty in severe cases. Your Artesian dealer should have a start-up and maintenance kit available for you when you purchase your spa.

# Topside Controller Instructions

---

## Initial Start up / Setting the Time of Day

---



### *Topside control for Island models*

---

After the spa has been powered up and the topside controller is finished displaying “Pr”, the user may control the various pumps, lights, temperature of the water, filter cycles, and choose between different modes of operation from this topside controller.

### **Setting the Time of Day**

---

When the spa is first powered up, the words “SET TIME” will flash on the display to set the time, press “Time”, then “Mode”, then “Warm” or “Cool”. After “Warm” or “Cool” is pressed once, the time will begin changing in one-minute increments. Press “Warm” or “Cool” to stop the time from changing. Press “Time” to enter your correct time into the system.

## **Light/ Mode/ Jets**

---

### **Light**

---

Press the “Light” button to turn the light on and off. If left on, the light automatically turns off after 4 hours.

### **Mode**

---

The mode is changed by pressing the up or down arrow then the mode key.

**Standard Mode** is programmed to maintain the desired temperature. Note that the last measured spa temperature is current only when the pump has been running for at least 1 minute. “St” will be displayed momentarily when you switch into Standard Mode.

**Economy Mode** heats the spa to the set temperature only during filter cycles. “Ec” will display solid when temperature is not current, and will alternate when temperature is current.

**Sleep mode** heats the spa to within 20°F/10°C of the set temperature only during filter cycles. “SL” will display solid when temperature is not current, and will alternate when temperature is current.

### **Jets**

---

Touch the “Jets1” “Jets2” or “Jets 3” button once to activate the respective pump and its jets(See the line drawings on pgs.6-37 for pump zones). Touch the respective “Jets” button again to turn off the pump. If left running, the pumps will automatically turn off after 15 minutes.

# **Topside Controller Instructions cont...**

## **Preset Filter Cycles/ Optional Filter Cycles**

### **Preset Filter Cycles**

The first filter cycle is automatically activated at 8:00am and operates the low speed of pump one\* (or the circulation pump if spa is equipped) until 10:00am.

The second filter cycle is automatically activated at 8:00pm and operated the low speed of pump 1 until 10:00pm.

the low speed of pump one and the ozone generator will run during filtration. At the start of each filter cycle, the therapy pumps will run on high speed for the first five minutes.

(\*) - Spa equipped with circulation pump is preset to run 24 hours from the factory, please see the next section to adjust the duration of the circulation pump cycle.

### **Optional Filter Cycles (Summer Mode)**

During the warm summer months it is advisable to lower the set temp to 85 F or less, to reduce the filter cycle circulation, and to set the spa in "economy mode".

While you are not required to set the filter cycles, if you want to change them press "Time", "Mode", "Mode" within three seconds. "SET START FILTER 1" (AM cycle) will appear on the display. Press "Warm" or "Cool" to reset the filter start time.

Press "Mode" to see "SET STOP FILTER 1" and adjust the time with "Warm" or "Cool" as done above. Press "Mode" to see "SET START FILTER 2" (PM cycle) and proceed as above.

Pressing "Mode" will enter the new filter cycle times into the system and display the current water temperature.

## **Topside Controller Instructions cont...**

---

### **Temp/Set (80°F - 104°F / 26°C - 40°C)/ Freeze Protection**

---

#### **Temp/Set (80°F - 104°F / 26°C - 40°C)**

The start-up temperature is set to 100°F/37°C. The Last measures temperature is constantly displayed on the LCD.

NOTE: The last measured spa temperature displayed is current only when the pump has been running for at least 1 minute.

To display the set temperature, press the “Cool” or “Warm” pad once.

To change the set temperature, press the pad a second time before the LCD stops flashing. Each press of the “Cool” or “Warm” pad will continue to either lower or raise the set temperature respectively.

After three seconds, the LCD will stop flashing and display the current spa temperature.

### **Freeze Protection**

---

If the temperature sensors detect a drop to below 44°F/6.7°C within the heater, the pump will automatically activate to provide freeze protection. The equipment stays on until 4 minutes after the sensors detect that the spa temperature has risen to 45°F/7.2°C or higher. In cold climates, an additional freeze sensor may be added to protect against freeze conditions that may not be sensed by the standard sensors. Aux freeze sensor protection acts similarly except with the temperature thresholds determined by the switch and without a 4-minute delay in turnoff. See your dealer for details.

# Diagnostic Messages

---

--

Temperature unknown.

After the pump has been running for 2 minutes, the temperature will be displayed

OHH

“Overheat” - The spa has shut down. One of the sensors has detected 118°F/48°C at the heater.

DO NOT ENTER THE WATER. Remove the spa cover and allow water to cool. Once the heater has cooled, reset by pushing any button. If spa does not reset, shut off the power to the spa and call your dealer or service organization.

OHS

“Overheat” - The spa has shut down. One of the sensors has detected that the spa water is 110°F/43°C.

DO NOT ENTER THE WATER. Remove the spa cover and allow water to cool. At 107°F/42°C, the spa should automatically reset. If spa does not reset, shut off the power to the spa and call your dealer or service organization

ICE

“Ice” - Potential freeze condition

No action required. The pump and blower will automatically activate regardless of spa status.

SnA

Spa is shut down. The sensor that is plugged into the Sensor “A” jack is not working.

If the problem persists, contact your dealer or service organization. (May appear temporarily in an overheat situation and disappear when the heater cools.)

SnB

Spa is shut down. The sensor that is plugged into the Sensor “B” jack is not working.

If the problem persists, contact your dealer or service organization. (May appear temporarily in an overheat situation and disappear when the heater cools.)

# Diagnostic Messages cont...

---

Sns

Sensors are out of balance. If alternating with spa temperature, it may just be a temporary condition. If flashing by itself, spa is shut down.

If the problem persists, contact your dealer or service organization.

HFL

A significant difference between temperature sensors has been detected. This could indicate a flow problem.

Check water level in spa. Refill if necessary. If the water level is okay, make sure the pumps have been primed. If problem persists, contact your dealer or

LF

Persistent low flow problems. (Displays on the fifth occurrence of "HFL" message within 24 hours.) Heater is shut down, but other spa functions continue to run

Follow action required for "HFL" message. Heating capability of the spa will not reset automatically; you may press any button to reset.

dr

Possible inadequate water, poor flow, or air bubbles in detected in the heater. Spa is shut down for 15 minutes.

Check water level in spa. Refill if necessary. If water level is okay, make sure the pumps have been primed. Press any button to reset, or this message will automatically reset within 15 minutes. If problem persists, contact your dealer or service organization.

dr4

Inadequate water detected in heater.

Check water level in spa. Refill if necessary. If water level is okay, make sure the pumps have been primed. Press any button to reset, or this message will automatically reset within 15 minutes. If problem persists, contact your dealer or service organization.

# MAINTAINING YOUR SPA

---

## DRAINING YOUR SPA

---

Your spa needs to be drained, cleaned, waxed, and refilled about every six months. More frequent water changes may be necessary if bather load is heavy. A hose bib has been provided below the left side of your front access panel, to assist you in draining your spa.

1) Turn off the power to your spa. If you fail to turn the power off, vital components could be damaged. Do not leave an empty spa exposed for long periods of time in hot, sunny weather.

**Valve Knob**



2) Attach your garden hose to the hose bib.

**Hose Bib**



3) Place the other end of the hose in an area that will accept the water capacity of your spa.

4) Open the hose bib by turning the valve knob counter-clockwise to the full stop position.

5) Check the garden hose end to see if water is flowing. If water is not flowing, check the hose for kinks. Also check to see if valve is in the full open position.

**CAUTION: The chemical content and temperature of the water will cause damage to certain vegetation. We do not recommend that you drain your spa onto plants or lawns. If you choose to do this, please remove your spa cover and allow spa to cool for a minimum of 24 hours with the spa turned off.**

## PILLOW CARE

---

Remove and clean the pillows with soapy water and a soft cloth when needed. Use a vinyl conditioner once a month. Remove pillows when doing chemical shock treatment.

## **JET CARE**

---

We recommended that you clean your jets when you drain your spa.

- 1) Spray jet inserts with a mixture of 1 part vinegar to two parts warm water and let soak for 10 - 15 minutes. Periodically rotate the spinner nozzle to break up residue in the jets.



- 2) Rinse the jet inserts with a standard garden hose



# MAINTAINING YOUR SPA cont...

---

## REMOVING, INSTALLING AND CLEANING FILTERS

---

These are the steps needed to successfully replace your filters. You should replace your disposable spa filters and clean your nondisposable filters every four months.

1) Turn off all power to your spa and remove the filter lid by lifting it out towards you.

2) Turn the filter counterclockwise and remove it from the filter well.

3) Dispose of the used filter.

5) To replace, set screen back into its place and turn clockwise to fasten. DO NOT over-tighten.

6) Place the new filter into position and turn clockwise to fasten. DO NOT over-tighten.

7) We recommend the use of a quality filter soak product. Please contact your dealer to purchase all your spa care products.



**WARNING: Power to your spa must be turned off prior to removing your filters. The suction at the filter is extremely strong and can cause injury if there is no filter. NEVER run your spa without the filters properly installed. Injury to person and damage to the equipment can occur. Any damage to equipment due to this circumstance will not be covered under warranty.**

## **WINTERIZING YOUR SPA**

It is not recommended that you drain your spa completely during freezing conditions. We recommend that you leave your spa full of water with the power on to keep the tub from freezing. If you decide to drain your spa during freezing conditions, contact your dealer for help. Contact your Artesian dealer before refilling a drained spa in freezing temperature.

**WARNING: Damage to your spa caused by freezing is NOT covered under warranty. Please contact your local Artesian dealer to assist you in winterizing your spa.**

## **REPLACING THE LIGHT BULB**

- 1) Turn off the power at the main electrical service panel.
- 2) Remove front access panel.
- 3) Locate and remove the reflector by turning it counterclockwise until free from wall fitting.
- 4) Remove the bulb from the holder.
- 5) Replace with new bulb. Your Artesian dealer has these bulbs in stock.
- 6) Replace the reflector by screwing it clockwise back onto the wall fitting.
- 7) Replace the front panel.
- 8) Turn power on at the main electrical service panel.

**NOTE: The spa light bulb is not covered under warranty. Also, any servicing of any multiple light systems should be done by an authorized service center.**

# **MAINTAINING YOUR SPA cont...**

---

## **SPA CABINET CARE**

---

Your spa comes standard with a PermaWood, or faux wood, cabinet. This cabinet requires no maintenance. You may wish to clean the cabinet with mild soap and water from time to time. If you elected to purchase your spa with a wood cabinet, this cabinet is stained and sealed with an oil based acrylic stain. The stain is formulated especially for spa cabinet and deck applications and is resistant to ultraviolet light damage caused by sun rays. It is also resistant to fungus and insect damage. Your Artesian dealer carries this type of stain for your convenience, so call your dealer when you're ready to re-stain your cabinet. You should re-seal your wood cabinet at least once a year, or more frequently depending on your environmental conditions.

- 1) Gently wash the cabinet with mild soap and water and allow to dry completely.
  
- 2) Moisten a rag with the stain you have purchased from your Artesian dealer.
  
- 3) Apply the stain on the entire cabinet surface, wiping off any excess stain as you are applying.
  
- 4) Allow stain to dry for a minimum of 24 hours before getting the cabinet wet.

**NOTE: Do not apply any solid type finish such as shellac or varnish. After weathering, these types of finishes will crack and/or turn yellow. To refinish the wood, you will need to completely strip the finish before applying the new one. Use only the stain recommended by your Artesian dealer for refinishing your spa.**

## **CLEANING YOUR SPA INTERIOR**

---

It is important to clean the interior of your spa every time it is drained to help preserve the sheen of your spa's surface. However, it is important that you do not use any abrasive cleaners or strong chemicals. Your Artesian Spas authorized dealer will be able to supply

you with the proper cleaning solution for your spa. After cleaning, make sure all residues are removed prior to filling the spa. This will help prevent sudsing and improper chemical balance.

## **COVER CARE**

---

Cleaning of your spa cover is an important part of routine maintenance. Dirt acts as an abrasive to the vinyl topcoat, and can also cause wear to folds, seams, and stitching. Mildew growing on damp, dirty vinyl will begin to actually root in the fabric, accelerating failure.

Follow this simple routine for cleaning, prior to application of vinyl

- 1) Rinse with cool water using a garden hose.
  
- 2) Spray with a gentle, non-foaming cleaner and wipe clean. Never use laundry detergent, abrasives, alcohols, dish soaps or harsh cleaners. These can actually remove some of the topcoat and cause premature vinyl failure.
  
- 3) For stubborn dirt, use a non-abrasive sponge.
  
- 4) Rinse again thoroughly with water and allow to dry.
  
- 5) Repeat monthly, or as needed.

Your vinyl cover is affected by the UV in sunlight. Periodic protectant with a liquid protectant will extend the life of your spa cover. The wrong kind of protectant can be more harmful than no protectant at all. Keep any product away from your spa that is labeled "flammable," that contains any type of oil, or that leaves a waxy coating on your cover.

Never stand or sit on the cover and never drag it over abrasive surfaces. Lift cover only by the handles provided.

# MAINTAINING YOUR SPA cont...

---

## CHEMICAL TREATMENT OF WATER

---

Water from your tap is fine for showers, bathing and drinking. However, in a contained recirculating system such as in a spa, water must be treated with chemicals. The main purpose of chemical treatment is to keep the water sanitary and to maintain a specific balance of the water. Proper balance ensures that the water will not cause irritation to the users or harm the spa's components. Chemical treatment does have its limitations. When water evaporates, chemical residues are left behind. As the levels of the residues combine with other types of residue, such as body oil and detergents, your water becomes increasingly difficult to maintain. Because of this residual effect, at some point it becomes easier and more cost-effective to drain, clean and refill your spa with new water. We recommend that the water be changed at least every six months. At this time you should also clean or replace your filters. If your spa has a frequent and/or heavy bather load, it may be necessary to drain and fill your spa more often. Refer to the section titled "Draining your spa" for instructions (page 59).

**WARNING: Spa damage due to improper chemicals use is not covered under warranty.**

# **WATER CHEMISTRY**

---

**CAUTION:** The chemicals used to maintain the pH balance of the water and to sanitize the water can be dangerous. Always follow these basic guidelines when handling the chemicals

1. Always read and follow the directions on the label, unless directed otherwise.
2. Never mix different chemicals.
3. Do not exceed the recommended amounts of chemicals—follow the directions on the label.
4. Keep all chemicals out of the reach of children and pets.
5. Keep containers closed tightly when not in use.
6. Never add water to the chemicals—always add the chemicals to the water as directed.
7. Always store chemicals in a cool, dry place.

**NOTE, Consult your dealer on local water chemicals as its varies from location to location.**

## **WATER TREATMENT GLOSSARY**

---

**1 - Total Alkalinity:** Total Alkalinity measures the water's ability to resist fluxuations in the pH level. It is measured in ppm (parts per million) ranging from 0 - 400 or up. The optimum range for your spa water is between 80 and 140. This can easily be measured with 3- or 5-way test strips. With low alkalinity the pH level will be prone todramatic fluxuations. With high alkalinity the pH becomes increasingly difficut to adjust.

**2 - pH (potential hydrogen):** The PH is used as a measurement of the active acidity, the concentration of active hydrogen molecules in the water. PH is measured on a scale from 1 to 14, the lower numbers indicating a greater concentration of active hydrogen. While 7, halfway between base and acid is neutral, the optimum level of acitivity for a spa is between 7.2 and 7.8.

# **WATER CHEMISTRY cont...**

---

## **WATER TREATMENT GLOSSARY cont...**

---

The effects of low PH can be rapid sanitizer loss, eye and skin irritation, expedited corrosion of metals, as well as staining throughout the spa. High PH can result in cloudy water, low sanitizer efficiency, as well as eye and skin irritation.

**3 - Parts per Million (PPM):** The term “parts pre million” will be used frequently in the world of water care. The term simply means exactly what it says: the coexistence of any one unlike item with a larger number of “like” items.

**4 - Sanitizers:** Sanitizers are used to destroy bacteria and other germs in the water. Only 2 sanitizers are used in spas, chlorine (Sodium Dichlor) and Bromine (Hydrotech or Lonza). Without the use of a mineral system or an enzyme, the preferred level of sanitizer is between 2 and 3 ppm.

**5 - Total Dissolved Solids (TDS):** TDS is simply the measure of the total amount of matter dissolved in the water. When this level becomes too high, action is advised.

**6 - Calcium Hardness:** The measure of the amount of calcium dissolved in the water as expressed in PPM. Hard water, or water with calcium levels over 250 PPM can cause scale formation on the surface of the spa or the components of the spa.

**7 - Total Chlorine:** Total Chlorine is the sum of the free and combined chlorines in the water. Often, water will contain a higher level of total chlorine than available chlorine. If this is the case in your water, you may use a non-chlorine shock (typically potassium monopersulfate) to free up the remainder of total chlorine.

**8 - Ozone:** Ozone is a gas molecule that can be generated by an Ozonator, which is composed of three atoms of oxygen and used to oxidize the water. Ozone is very useful for regenerating bromine from bromide ions. It also acts as a supplement when used in conjunction with a sanitizer and may reduce the level of sanitizer required. You may read more about ozone later in this section of your owner’s manual.

**9 - Organic Matter:** These are carbon-derived substances typically generated by living organisms. In a spa, they are most frequently introduced into the water by bathers. Enzyme products such as Spa Perfect by Natural Chemistry are most effective at eliminating organic matter from your body of water.

**10 - Microorganisms:** This term refers to tiny, living organisms such as bacteria, protozoa, or algae.

**11 - Sequestering:** This term defines the action taken to remedy high levels of metals or calcium in the water. By forming a complex that envelops materials in the water, commonly hardness ions, a sequestering chemical prevents the ions from reacting to one another, thus forming complex structures or solids.

**12 - Shocking:** Shocking is the act of hyper-chlorinating or hyper-oxidizing the water. This can be accomplished with a myriad of shock treatments, but is most commonly accomplished with Sodium Dichlor or Potassium Monopersulfate. The former raises the sanitizer level to at least 8 PPM, and the latter burns off chloramines or bromines. The use of P.S., or non-chlorine shock is advantageous because you can bathe only 15 minutes after treatment; however, oxidizing the water will not kill the bacteria unless there is sufficient total chlorine to free up used chlorine to actively sanitize.

**13 - Bather Load:** You may be asked by your spa professional what the average bather load is, meaning, how many people enter the spa on a daily or weekly basis.

**14 - Alternative Sanitizers** a group of products that sanitize pool, spa and hot tub water, by means other than the application of chemicals to the water. Includes such products as ultraviolet sanitizing systems, mineral purifiers, ionizers and ozonators.

**15 - Bactericide:** a chemical that kills bacteria. The most common-bactericides are: chlorine, bromine, biguanide, ozone and silver. Most algaecides, other than copper, exhibit some bactericidal properties.

**16 - Balanced Water:** pool or spa water that is within the accepted water analysis parameters for: pH, sanitizer, total alkalinity, calcium hardness, chlorine stabilizer (chlorine pools only) and minerals. The balancing, of the pool or spa water, helps to eliminate water chemistry problems.

# **WATER CHEMISTRY cont...**

---

## **WATER TREATMENT GLOSSARY cont...**

---

**17 - Chloramines:** irritating, odorous forms of combined chlorine, formed by the reaction of chlorine with nitrogen containing waste products. Chloramines are ineffective as a pool or spa sanitizer. High levels of chloramines can cause the problems of “Red Eyes” or “Stinging Eyes.” Usually requires a shock treatment to lower or destroy the combined chlorine level.

**18 - Corona Discharge:** a method for producing ozone, by utilizing high voltage arcing to convert oxygen (O<sub>2</sub>) into ozone (O<sub>3</sub>). Refer to the listing for Ozone for more information.

**19 - Enzymes:** organic agents that hasten the natural breakdown (digestion) or decomposition of oily wastes and organic residues in pools and spas.

**20 - Hard Water:** the term used to describe water that is high in calcium or magnesium. High levels, usually over 400 PPM, can lead to clarity and scaling problems, if not treated. Source of the calcium can be natural or can be contributed by chemicals such as calcium hypochlorite.

**21 - Ions:** the electrically charged state that an element assumes in true solution. In the ionic state, ions are chemically reactive. Some ions, such as, copper, silver and zinc, are used as sanitizers in mineral purifiers and/or ionizers.

**22 - Ionizers:** equipment that sanitizes pool and spa water by providing a low level source of copper and silver ions, as the water passes over charged electrodes. Copper ions can provide algaecidal control. Silver ions can provide bactericidal control. Other types of devices (mineral purifiers) work by an erosion principle and utilize copper, silver or zinc ions. Spa ionizers often lack the copper element because the need for algae control is not as acute as in a pool.

**23 - Mineral Purifier:** a type of device that releases copper, silver or zinc ions into the water at very low levels. In this ionic state, these minerals can function in the sanitizer role and help control algae and bacteria in pool and spa water. Mineral Purifiers work on the principle-

of erosion and do not require electrical components. Most include some type of replaceable cartridge, that contains the copper, silver or zinc materials.

**24 - Biguanide:** the generic name for a non-chlorine, non-bromine, sanitizer that utilizes the polymer PHMB (polyhexamethylene biguanide). It is used to totally eliminate the use of chlorine or bromine.

**25 - Biofilm:** a slippery coating of microorganisms that can develop in poorly sanitized pools and spas.

**26 - Brominator:** feeding devices used to introduce bromine into pools or spas. Most automatic types can be plumbed inline. Others are simple floating varieties. All are intended to make the application of bromine easier and more consistent.

**27 - Calcium Carbonate:** crystalline deposits (scale) that can form on all under water surfaces, if the water is excessively high in calcium hardness. High pH and high total alkalinity can worsen the problem.

**28 - Oxidation:** the chemical reaction by which organic matter is “burned” or destroyed, by the action of chlorine, bromine, ozone, hydrogen peroxide or non-chlorine shock. Oxidation may cause minerals such as iron, manganese and copper to form discoloring stains and precipitates, if not treated properly.

**29 - Ozonator:** a device for producing Ozone (O<sub>3</sub>), by either a UV (ultraviolet) light source or by electrical arcing (corona discharge). Used for oxidizing and sanitizing purposes in both pools and spas.

**30 - Ozone (O<sub>3</sub>):** typically produced by an Ozonator installed in a pool or spa. Ozone (O<sub>3</sub>) is a form of oxygen (O<sub>2</sub>) and is a powerful oxidizing agent. It is used to destroy organic waste and byproducts and help in the control of algae and bacteria. Ozone is not a stand alone sanitizer and requires the supplementation of chlorine, bromine, minerals, or ionization.

**31 - Soft Water:** is water that is low in calcium and magnesium hardness. Such water can prove to be corrosive to masonry surfaces and underwater metal parts. The calcium hardness level can be raised, to the optimum range of 150-200 PPM, by the addition of appropriate amounts of a calcium hardness increaser (calcium hardness).

# **WATER CHEMISTRY cont...**

---

## **SPA CHEMICALS GLOSSARY**

---

**1 - Alkalinity Up:** The total alkalinity of your spa water should be between 80-140 PPM. A proper alkalinity will help buffer your spa water against sudden changes in pH. Every 2.5 tablespoons of Alkalinity Up will raise your alkalinity by 10 PPM in a spa holding 500 gallons of water.

**2 - Bromine Tablets:** These slow-dissolving tablets work especially well in the hot water of your spa. Keep a base of tablets inside of an in-spa floater/feeder in order to maintain between 2 and 5 PPM. Add 2 tablets per 100 gallons of water and adjust the floater's opening to regulate the PPM level.

**3 - Foam Gone:** Foam in spas is typically caused by residue from soap, shampoo, and cleansers. A small amount of Foam Gone will dissipate the foam and will not affect the water balance. Most foam removers are compatible with all sanitation programs.

**4 - Liquid Filter Cleaner:** Regular use of Filter Cleaner will greatly increase the life and performance of your filters by cutting away grease, body oils, scale, and lotions. Clean filters also contribute to better water circulation and superior spa performance, because dirty filters can substantially impede water flow. Keeping your filters clean with filter cleaner will also help keep your water filtered and clear. This is accomplished by mixing one pint of filter cleaner with 2.5 gallons of water and submerging the filters in the mixture for at least 12 hours.

**5 - Dichlor Granular:** This concentrated, stabilized, and quick dissolving chlorine granular is simple to use in your spa as a sanitizing-shock treatment. The downside to Dichlor is that it will not sustain a PPM base for long in hot water. However, as a rule of thumb, if you treat your water after bathing with half a capful of Dichlor, you will maintain clear and comfortable water, providing your pH is controlled and your filters cleaned. Dichlor dissolves quickly and leaves no residue.

**6 - pH Down:** If your pH level remains high, you can struggle with scaling, cloudy water, rapid sanitizer loss, and possible skin and eye irritation. pH Down can be purchased from your dealer in either liquid or solid granular form. Please see your dealer for recommended dosage.

**7 - pH Up:** The effects of low pH can be rapid sanitizer loss, eye and skin irritation, expedited corrosion of metals, as well as staining throughout the spa. pH up can be purchased from your dealer in either liquid or solid granular form. Please see your dealer for recommended dosage.

**8 - Metal Protect or Remover:** Also called stain and scale defense, metal protect inhibits staining and scaling in your spa. It will also prevent calcium build-up on the surfaces of your spa. Regular use will help protect your spa surface as well as your plumbing, your pumps, and even your heater.

**9 - Spa Shock:** Non-chlorine spa shock contains Potassium Monopersulfate and is an oxidizer that works well with mineral, chlorine and bromine systems. Regular use of spa shock can substantially reduce the need for sanitizing by up to 50% and will continually remove inorganics from the water. Best of all, you can bath in only 15 minutes after application.

**10 - Ascorbic Acid:** vitamin "C." Can be used as an acidic reducing agent in the removal of difficult metallic stains from underwater surfaces. Oxalic acid can be used in a similar manner.

# **WATER CHEMISTRY cont...**

---

## **MAINTAINING THE PROPER pH BALANCE**

---

The pH factor is a measure of the relative acidity or alkalinity in the water. It is measured on a scale of 1 to 14. Pure water has a value of 7, which is neutral. Any value above 7 is alkaline, and any value below 7 is acidic. You should maintain a slightly alkaline pH level, between 7.2 and 7.8, in the hydrotherapy spa. Severe problems can occur when the pH balance is not maintained within this range. If the pH level exceeds 7.8, dissolved minerals can build up and clog the plumbing in the spa jet unit. If the pH level falls below 7.2, the acid level in the water will begin to corrode the metal parts in the spa jet unit. Also, the sanitation agents in the water will not be effective if the pH level is not properly maintained. Damage caused by improper pH levels is not covered under the warranty. To maintain the proper pH level, you should test the pH of the water regularly. To test the water, purchase a pH test kit at a pool and spa supplier. The pH reading should be between 7.2 and 7.8. If the level is too low, add a pH increaser (usually soda ash). If the level is too high, add a pH reducer (usually sodium bisulfate). Test the water again after five minutes. See the instructions with your pH test kit for additional information about testing and adjusting the pH.

## Artesian Spa Island Class Warranty

---

This section is a description of your warranty. Here you will find descriptions of what is covered under your Island Class Spa warranty and what can void your warranty. For warranty outside USA and Canada, please refer to your countries Artesian Distributor.

### ***Lifetime Structure Warranty***

Island Class Spas carry a lifetime structure warranty. The structure is defined as the shell below the exposed material finish. The manufacturer warrants the spa against loss of water due to a defect in the spa structure. In the event of a defect in the material and/or workmanship, the spa structure will be repaired or replaced at the discretion of the manufacturer. ***THIS WARRANTY IS GIVEN ONLY TO THE ORIGINAL OWNER, AND TERMINATES UPON TRANSFER OF OWNERSHIP. COMMERCIAL APPLICATIONS ARE EXCLUDED FROM THIS AND ALL WARRANTIES.***

If the spa structure is defective and must be replaced, it will be returned to the factory. The original, installed equipment ( this includes the frame, skirt, and all equipment) will be reinstalled. If new equipment is desired, there will be additional charges to the customer.

If the frame and/or skirt of the spa has been badly damaged, there will be additional charges to the spa owner for repairs or replacement. When a spa needs to be returned to the factory for repair, the cost of freight to the company will be at the spa owner's expense. The manufacturer will not pay for removal, installation, cranes, construction, de-construction, or any other cost associated with access, egress, or ingress, of the spa at the customer's home. The manufacturer reserves the right to an on-site inspection by its authorized representative. In the unlikely event a shell or spa must be replaced, all warranties (shell, surface, electrical and plumbing) date back to the original date of installation.

### ***Five Year Surface Warranty***

The spa surface is described as the exposed acrylic material finish. The manufacturer warrants the spa surface to be free from defects in the material and workmanship, such as blistering, cracking, or delaminating, under normal use and maintenance for a period of five years from the original date of delivery. ***THIS WARRANTY IS GIVEN ONLY TO THE ORIGINAL OWNER, AND TERMINATES UPON***

**TRANSFER OF OWNERSHIP. COMMERCIAL APPLICATIONS ARE EXCLUDED FROM THIS AND ALL WARRANTIES.** The spa must be set on a level solid surface that is sufficient to support the entire length and width of the spa. Standard building practices must be followed. Damage caused by failure to have a leveled and supported foundation under the spa is not covered under warranty. The manufacturer does not warrant problems associated with prolonged exposure to the sun and/or use of any sanitization or ozone system not approved by the manufacturer. Damage to the spa surface caused by leaving the spa uncovered and empty of water with direct sunlight exposure will terminate this warranty. Any alteration to any system, either electrical, plumbing, or mechanical, or over use of chemicals, or any other problems caused by external source are not covered under warranty. Other exclusions may apply. Please read the warranty thoroughly.

Normally problems associated with material and workmanship can and will be repaired. If the spa surface is repaired, the repair is limited to the affected area only, and there is no guarantee against discoloration or fading. The decision to repair will be made by the manufacturer and its field representative after a review of the facts, pictures, or any other data presented by the dealer or customer. In all cases, pictures of the affected area and foundation or the spa must be provided before any decisions to repair or replace can be made. In the unlikely event a shell or spa must be replaced, all warranties ( shell, surface, electrical and plumbing) date back to the original date of installation. If it is determined that the surface is to be replaced, the same conditions and terms as outlined in the shell warranty will apply.

### ***Three-year Electrical Warranty***

(i.e., pumps, equipment packs, heaters, topside, etc.)

The MANUFACTURER warrants all electrical equipment to be free from defect in material and workmanship for three-years. THIS WARRANTY IS GIVEN TO THE ORIGINAL CONSUMER AND TERMINATES UPON TRANSFER OF OWNERSHIP. COMMERCIAL APPLICATIONS ARE EXCLUDED FROM THIS AND ALL WARRANTIES. The stereo, speakers, L.E.D. lighting, and Ozone are not included in this warranty but are covered under a separate warranty. Damage caused by weather, poor water chemistry, and/or improper maintenance will not be covered under this warranty. Alterations or replacements of components installed in the spa that are not purchased and/or approved by the MANUFACTURER, including incorrect wiring, will terminate the complete spa warranty.

## **WARRANTY cont...**

---

APPLICATIONS ARE EXCLUDED FROM THIS AND ALL WARRANTIES. The stereo, speakers, L.E.D. lighting, and Ozone are not included in this warranty but are covered under a separate warranty. Damage caused by weather, poor water chemistry, and/or improper maintenance will not be covered under this warranty. Alterations or replacements of components installed in the spa that are not purchased and/or approved by the MANUFACTURER, including incorrect wiring, will terminate the complete spa warranty.

### ***Three Year Plumbing Warranty***

The plumbing is described as all piping, jet bodies, and valve bodies. The manufacturer warrants all plumbing for a period of three years from the date of installation. THIS WARRANTY IS GIVEN ONLY TO THE ORIGINAL OWNER, AND TERMINATES UPON TRANSFER OF OWNERSHIP. COMMERCIAL APPLICATIONS ARE EXCLUDED FROM THIS AND ALL WARRANTIES. Jet internals, valve handles, and such items are regular maintenance items. They are covered for the item only, labor is not covered for these items. Damage caused by weather, poor water chemistry, and/or improper maintenance will not be covered under this warranty.

### ***One Year Cabinet Warranty***

The spa cabinet is described as the outer material encasing the spa. The manufacturer warrants it to be free from defects in material and/or workmanship from the date of original installation. THIS WARRANTY IS GIVEN ONLY TO THE ORIGINAL OWNER, AND TERMINATES UPON TRANSFER OF OWNERSHIP. COMMERCIAL APPLICATIONS ARE EXCLUDED FROM THIS AND ALL WARRANTIES. This warranty does not cover normal darkening, staining, or aging. The spa cabinet requires care and maintenance by the consumer. Damage caused by weather, poor water chemistry, and/or improper maintenance will not be covered under this warranty.

### ***Other Items Not Covered In This Warranty***

Some items are not covered in this warranty. These items either have a different warranty, or are warranted through the manufacturer of that item.

### ***Stereo and Stereo Components***

The stereo and stereo components, including speakers, sub woofer, wire harness, and remote control are covered for 30 days from the date of installation, parts and labor. 1 year parts only. This warranty does not cover damage to a stereo or stereo component from abuse, poor reception, or damage caused by putting a wet CD into the stereo. If a stereo is replaced under this warranty, the manufacturer reserves the right to replace the unit with another like unit, but not necessarily the same stereo manufacturer. No spa will be replaced for failed stereo. The stereo does not affect the performance of the spa.

NOTE: For all operating instructions see the stereo manufacturer's owner's manual included with the spa.

### ***Ozonator***

The ozonator is covered for one year from the date of Installation.

### ***Spa Cover***

The spa cover manufacturer warrants the spa spa cover skin for one year. Do not return the spa cover to the manufacturer. This will delay the replacement or repair of the cover. The spa manufacturer is not responsible for lost covers.

### ***Lighting***

The lighting is guaranteed to work upon delivery. There is no warranty covering the lighting.

### ***Performance***

In the event of any defect covered by this LIMITED warranty, a May-Manufacturing LLC, authorized agent will correct such defect within the terms and conditions contained herein. There will be no charge for parts or labor within the above terms. However, travel charges that occur will not be covered under terms and conditions by the warranty. If it is determined by May Manufacturing LLC that the repair of the product is not feasible, a replacement spa equal to the value of the original purchase price will be provided. Cost for removal of the defective spa and delivery and installation of the replacement spa is the responsibility of the homeowner and will not under any circumstances be covered by May Manufacturing LLC.

# WARRANTY cont...

---

## ***Limitations***

This warranty is void if this Artesian Spa has been subjected to alteration, misuse, or repairs have been performed by anyone other than an authorized agent of May Manufacturing LLC. Misuse or abuse is defined as: use of the spa in a nonresidential application, water temperature outside the range of 32 degrees F to 110 degrees F, damage caused by clogged or dirty filter cartridges, damage to the spa from an absence of a hard cover, damage to components from improper pH, use of any type of acid, or from chemical imbalance. ACTS OF NATURE are not covered under this warranty.

Note: Warranty on 50Hz spas excludes labor.  
(outside US and Canada)

## ***Disclaimer***

May Manufacturing LLC, or its agent shall not be liable for any injury, cost or other damage, whether incidental or consequential, arising out of any defect covered by the LIMITED WARRANTY. The liability of May Manufacturing LLC under this LIMITED WARRANTY shall not exceed the original amount paid for the spa.

## ***Legal Remedies***

This LIMITED WARRANTY gives specific rights, and other rights that may apply will vary from state to state.

### ***What is Not Covered Under Your Warranty***

The following is a general overview of non-warranty items and work. This is not an all-inclusive list.

*Diagnosis of Spa Problems*

*Fuses*

*Light Bulbs of Any Kind*

*Removing a Spa from a Structure*

*Pillows*

*Filters*

*Chemical Misuse*

*Filter Lids*

*Any Part not Purchased from Artesian Spas*

*Jet Inserts*

*Valve Handles*

*Pump Seals*

*Draining and filling the Spa*

*Acts of Nature*

*Travel Charges*

*Cabinet Screws*

*Incorrect Wiring*

*Shipping Charges*

***THIS WARRANTY IS GIVEN ONLY TO THE ORIGINAL OWNER, AND TERMINATES UPON TRANSFER OF OWNERSHIP. COMMERCIAL APPLICATIONS ARE EXCLUDED FROM THIS AND***

Any alteration of the spa that has not been pre-authorized by the manufacturer will void all warranties. If the manufacturer approves an alteration, verify that this alteration is covered under warranty. Damage caused by moving a spa that is blocked in or that has been recessed, along with additional charges for labor, is not covered by this warranty.

# INTERIOR SPA DIAGRAM

---





**1) Spa Pack**

**2) Heater**



**3) Therapy Pump**



---

---

---

Please do not send products or other correspondence to the address below.

Place  
Stamp  
Here

**ARTESIAN SPAS**  
Attn: Customer Care Department  
4720 N. Lamb Blvd.  
Las Vegas, NV 89115

Mr

Ms.

Name \_\_\_\_\_

Address \_\_\_\_\_

City \_\_\_\_\_ State \_\_\_\_\_ Zip \_\_\_\_\_

Phone Number \_\_\_\_\_

Date of Installation \_\_\_\_\_ Spa Serial Number \_\_\_\_\_

Spa Model \_\_\_\_\_

Your Dealers Name and Location \_\_\_\_\_

What other spa brands did you consider buying? \_\_\_\_\_

**Optional Questions**

How many people are in your household? \_\_\_\_\_

What is your age bracket?    25-30        31-40        41-50        51-60        61-70        71+   

What is your reason for purchasing a spa?    Health Benefits    Stress    Relief    Relaxation

Other: \_\_\_\_\_