

# AKAI

## Bluetooth CD+G Karaoke System with Pedestal

### INSTRUCTION MANUAL

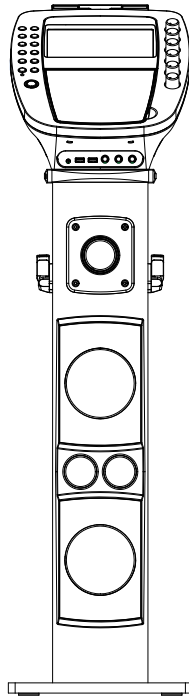

**KS878-BT**

Thank you for purchasing this Karaoke System. Please read this instruction manual carefully before using this product to ensure proper use. Keep this manual in a safe place for future reference.

[www.AKAI-USA.com](http://www.AKAI-USA.com)

# WARNINGS

**WARNING:** TO REDUCE THE RISK OF FIRE OR SHOCK HAZARD, DO NOT EXPOSE THIS PRODUCT TO RAIN OR MOISTURE.

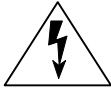

## CAUTION

RISK OF ELECTRIC SHOCK  
DO NOT OPEN



**CAUTION:** TO PREVENT THE RISK OF ELECTRIC SHOCK, DO NOT REMOVE COVER OR BACK. NO USER-SERVICEABLE PARTS INSIDE. REFER SERVICING TO QUALIFIED PERSONNEL.

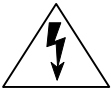

This symbol is intended to alert you to the presence of uninsulated dangerous voltage within the product's enclosure that might be of sufficient magnitude to constitute a risk of electric shock. Do not open the product's case.



This symbol is intended to inform you that important operating and maintenance instructions are included in the literature accompanying this product.

## DRIPPING WARNING

The product shall not be exposed to dripping or splashing and that no objects filled with liquids, such as vases, shall be placed on the product.

## VENTILATION WARNING

The normal ventilation of the product shall not be impeded for intended use.

Class II equipment symbol



This symbol indicates that the power adaptor has a double insulation system.

**This device complies with Part 15 of the FCC Rules. Operation is subject to the following two conditions: (1) this device may not cause harmful interference, and (2) this device must accept any interference received, including interference that may cause undesired operation.**

**Warning:** Changes or modifications to this unit not expressly approved by the party responsible for compliance could void the user's authority to operate the equipment.

## FCC RADIATION EXPOSURE STATEMENT

This equipment complies with FCC's and IC's RF radiation exposure limits set forth for an uncontrolled environment. The antenna(s) used for this transmitter must be installed and operated to provide a separation distance of at least 20 cm from all persons and must not be collocated or operating in conjunction with any other antenna or transmitter. Installer must ensure that 20 cm separation distance will be maintained between the device and user.

## DECLARATION DE LA FCC RELATIVE A L'EXPOSITION AU RAYONNEMENT

Cet appareil est conforme aux limites d'exposition au rayonnement RF stipulées par la FCC et IC pour une utilisation dans un environnement non contrôlé. Les antenne utilisées pour cet émetteur doivent être installées et doivent fonctionner à au moins 20 cm de distance des utilisateurs et ne doivent pas être placées près d'autres antennes ou émetteurs ou fonctionner avec ceux-ci. Les installateurs doivent s'assurer qu'une distance de 20 cm sépare l'appareil des utilisateurs.

FCC ID : OWT-KS878BT

# FCC AND CANADIAN ICES

---

NOTE: This equipment has been tested and found to comply with the limits for a Class B digital device, pursuant to part 15 of the FCC Rules. These limits are designed to provide reasonable protection against harmful interference in a residential installation. This equipment generates, uses and can radiate radio frequency energy and, if not installed and used in accordance with the instructions, may cause harmful interference to radio communications. However, there is no guarantee that interference will not occur in a particular installation. If this equipment does cause harmful interference to radio or television (which can be determined by turning the equipment off), the user is encouraged to try to correct the interference by one or more of the following measures:

- Reorient or relocate the receiving antenna.
- Increase the separation between the equipment and receiver.
- Connect the equipment into an outlet on a circuit different from that to which the receiver is connected.
- Consult the dealer or an experienced / TV technician for help.

NOTE: This digital apparatus does not exceed the Class B limits for radio noise emissions from digital apparatus as set out in the radio interference regulations of Industry Canada.

Le présent appareil numérique n'émet pas de bruits radioélectriques dépassant les limites applicables aux appareils numériques de Classe B prescrites dans le règlement sur le brouillage radioélectrique édicté par Industrie Canada.

## IMPORTANT SAFETY INSTRUCTIONS

---

1. Read these Instructions.
2. Keep these Instructions.
3. Heed all Warnings.
4. Follow all instructions.
5. Do not use this apparatus near water.
6. Clean only with a dry cloth.
7. Do not block any of the ventilation openings. Install in accordance with the manufacturers instructions.
8. Do not install near any heat sources such as radiators, heat registers, stoves, or other apparatus (including amplifiers) that produce heat.
9. Do not defeat the safety purpose of the polarized or grounding - type plug. A polarized plug has two blades with one wider than the other. A grounding type plug has two blades and a third grounding prong. The wide blade or the third prong are provided for your safety. When the provided plug does not fit into your outlet, consult an electrician for replacement of the obsolete outlet.
10. Protect the power cord from being walked on or pinched particularly at plugs, convenience receptacles, and the point where they exit from the apparatus.
11. Only use attachments/accessories specified by the manufacturer.
12. Use only with a cart, stand, tripod, bracket, or table specified by the manufacturer, or sold with the apparatus. When a cart is used, use caution when moving the cart/apparatus combination to avoid injury from tip-over.







### **Portable Cart Warning**

13. Unplug this apparatus during lightning storms or when unused for long periods of time.
14. Refer all servicing to qualified service personnel. Servicing is required when the apparatus has been damaged in any way, such as power-supply cord or plug is damaged, liquid has been spilled or objects have fallen into the apparatus, the apparatus has been exposed to rain or moisture, does not operate normally, or has been dropped.

# IMPORTANT SAFETY INSTRUCTIONS

## WARNINGS:

- To reduce the risk of fire or electric shock, do not expose this apparatus to rain or moisture.  
Avertissement: pour réduire le risque d'incendie ou de choc électrique, ne pas exposer cet appareil sous la pluie et l'humidité.
- The apparatus shall not be exposed to dripping or splashing and that no objects filled with liquids, such as vases, shall be placed on apparatus.  
L'appareil ne doit pas être exposé aux écoulements ou aux éclaboussures et aucun objet ne contenant de liquide, tel qu'un vase, ne doit être placé sur l'objet.
- The MAINS plug / power adaptor is used as the disconnect device, it should remain readily operable during intended use.  
In order to disconnect the apparatus from the mains completely, the main plug / power adaptor should be disconnected from the mains socket outlet completely.  
La prise du secteur ne doit pas être obstruée ou doit être facilement accessible pendant son utilisation.  
Pour être complètement déconnecté de l'alimentation d'entrée, la prise doit être débranchée du secteur.
- Battery shall not be exposed to excessive heat such as sunshine, fire or the like.  
Les piles ne doivent pas être exposées à de forte chaleur, tel qu'à la lumière du soleil, au feu ou autres choses de semblable.
- Caution Marking and rating plate was located at bottom enclosure of the apparatus.  
Les marquages sont inscrits en bas de l'appareil.  
Les précautions d'emploi sont inscrites en bas de l'appareil.

	DC voltage
	Caution Please refer for further information to the user manual
 	<b>RECYCLING</b> This product bears the selective sorting symbol for Waste electrical and electronic equipment (WEEE). This means that this product must be handled pursuant to European directive 2012/19/EU in order to be recycled or dismantled to minimize its impact on the environment. User has the choice to give his product to a competent recycling organization or to the retailer when he buys a new electrical or electronic equipment.
	Polarity of d.c. power connector

# WHAT'S IN THE BOX

---

## Contents

1. CD+G Pedestal Karaoke System



2. Tablet Cradle



3. AV Cable



4. Pre-recorded Karaoke CD+G Disc



5. 2 x Dynamic Microphone

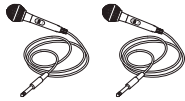

6. AC-DC Power Adaptor



7. Instruction Manual



8. Warranty Card



If you are missing any parts above, please contact ADT Digital LLC.

Tel: 561 922 6886

Fax: 561 922 6159

# CONTROL LOCATION

## TOP VIEW

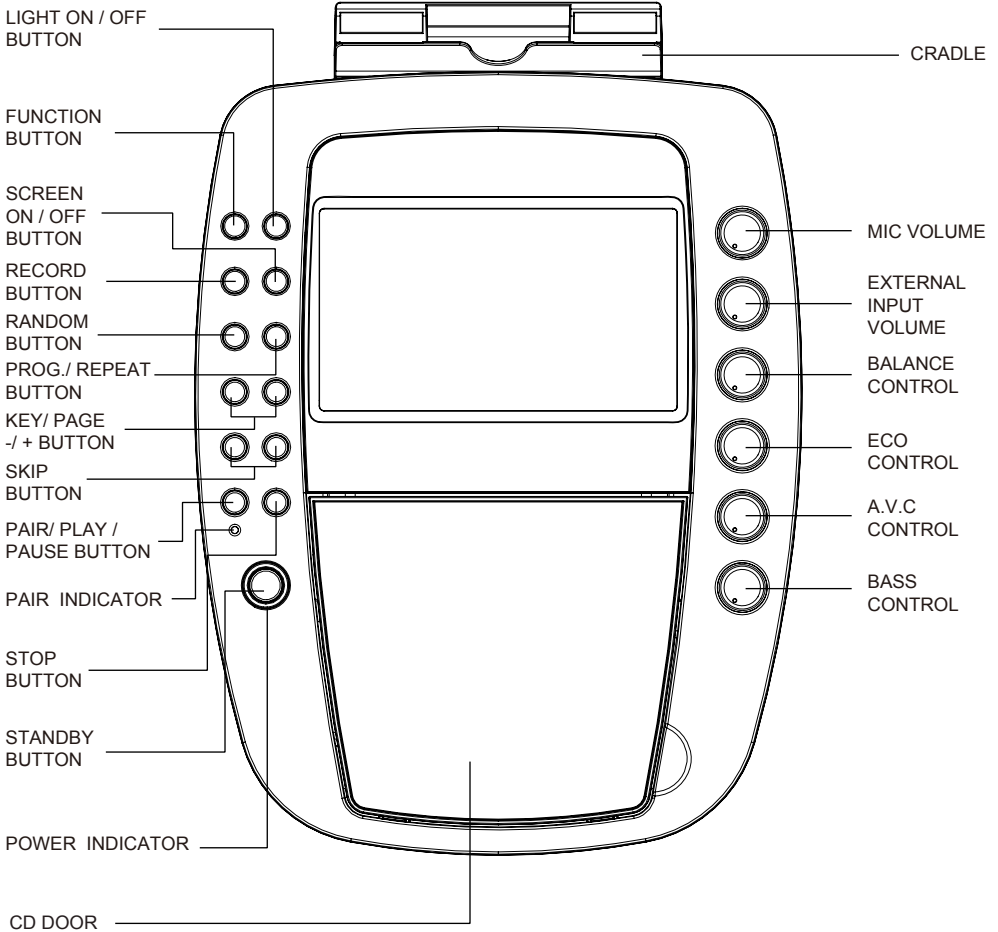

# CONTROL LOCATION

## TOP VIEW

## REAR VIEW

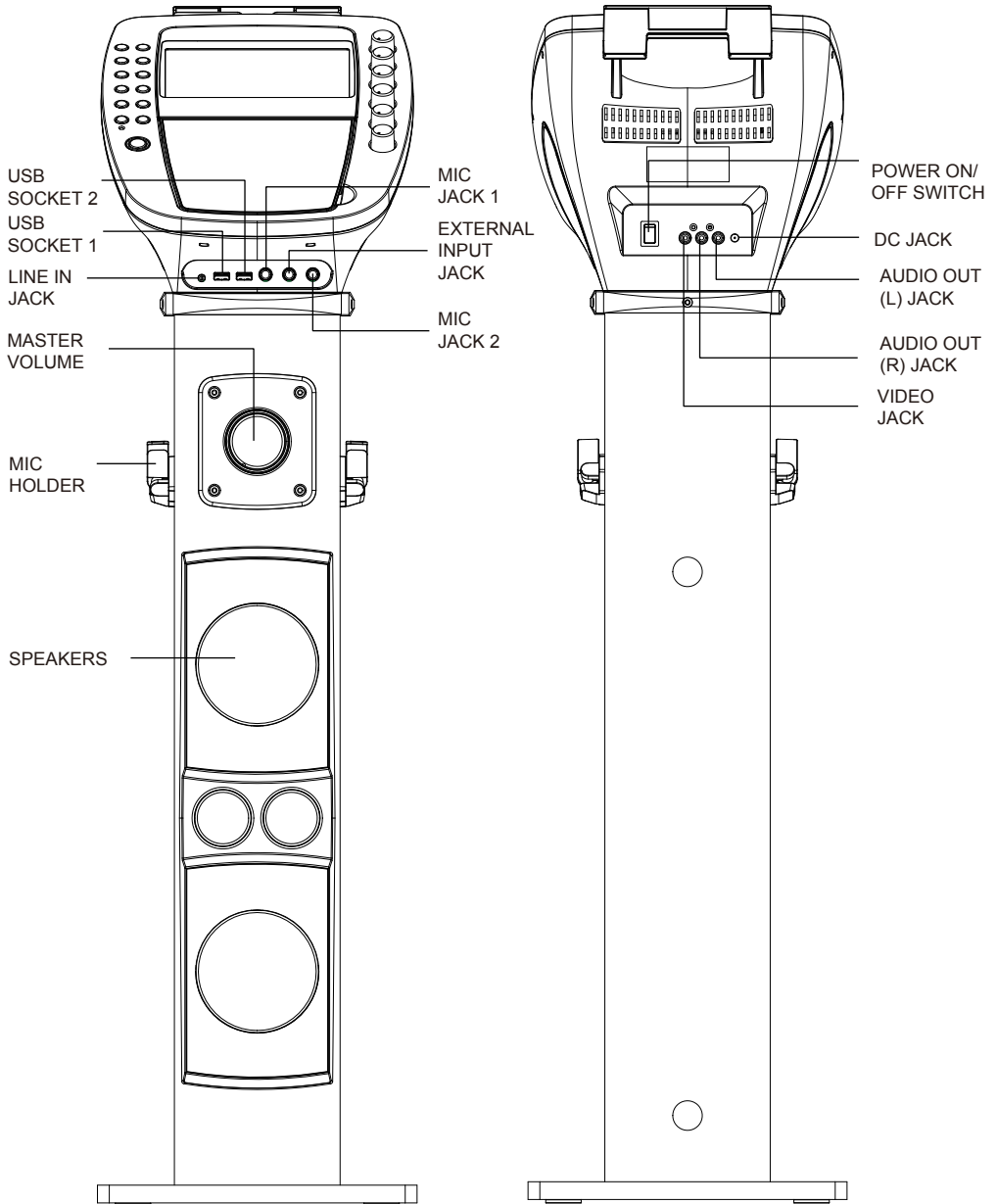

# TFT DISPLAY ICON

---

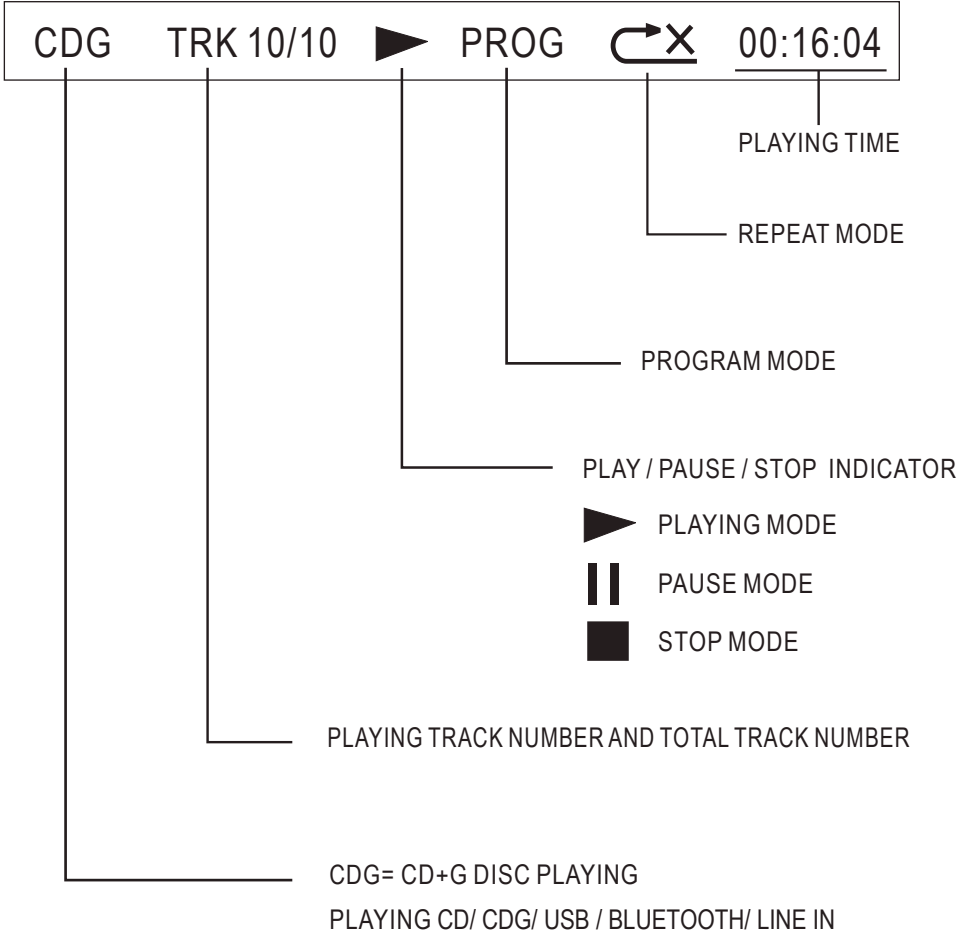



# MAKING THE CONNECTIONS

## CONNECTING POWER

Plug the supplied power adaptor small end into the DC jack located on the rear panel, plug the adaptor into the standard AC wall socket.

**CAUTION:** The unit is designed to operate from a mains supply of AC 100-240V~50/60Hz. If the adaptor does not fit properly, turn it over and try again. Do not force it.

**NOTES:** When the unit is not operated by the AC power or unused for long periods of the time. Please remove the power adaptor from the wall outlet and unplug from the main unit.

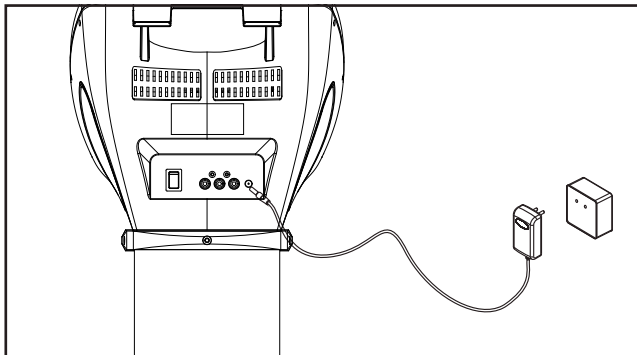

## CONNECTING TO YOUR TV OR VCR / HOME THEATER

Your Karaoke machine is designed to connect to your TV the same way you would connect most video cameras, VCR / Home theater or video games consoles. We have provided RCA cables to connect your unit to a TV, VCR / Home theater, video device or an external audio / sound system. The RCA cables have three connections at each end (white and red are for left and right audio connections and the yellow is for video connections).

## VIDEO CONNECTION

Please follow the steps below to display CD+G lyrics on the TV screen:

1. Locate the multi-colored RCA cables
2. Connect video cable (yellow) to the Video Out of the back of the Karaoke Machine
3. Connect the other end of the video cable (yellow) to the video input on your TV or VCR / Home theater.

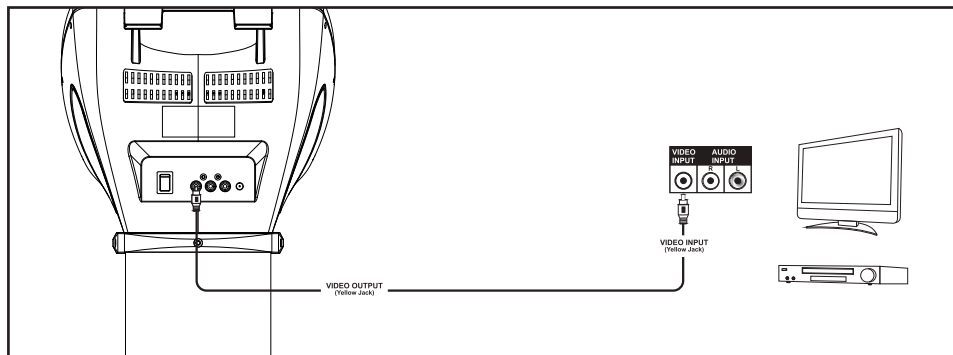

# MAKING THE CONNECTIONS

## SELECTING YOUR KARAOKE MACHINE AS YOUR SOURCE/INPUT

Selecting your Karaoke Machine as a source / input on your TV is very similar to connecting a VCR/DVD or Satellite system.

We've listed below the most common ways of selecting the source from your TV or VCR / Home Theater:

1. In the set up menu of the TV or VCR / Home theater there may be an option for "Input Select" where you can choose between "Cable/Ant., Video 1, Video 2, etc" as the input source.
2. Look for a TV channel between the highest and lowest on your TV or VCR / Home theater (i.e AUX, EXT, LINE 1 or LINE IN)
3. Your remote control for your TV or VCR / Home Theater may have source input selections as well as detailed below: "Video, Video 1, Game, AUX, EXT or LINE-IN." Choosing one of those sources in most cases should display the lyrics from your **Karaoke Machine** as well.

## AUDIO CONNECTION

Please follow the steps below to connect audio signal from the unit to your TV, VCR/Home Theater or home audio system.

### RCA connection

1. Locate the multi-colored RCA cables (White and Red)
2. Connect audio cables to the **Audio Out** of the back of your Karaoke Machine.
3. Connect the other end of the audio cables to the Audio/Auxiliary input on your TV or VCR/Home Theater or home audio system.

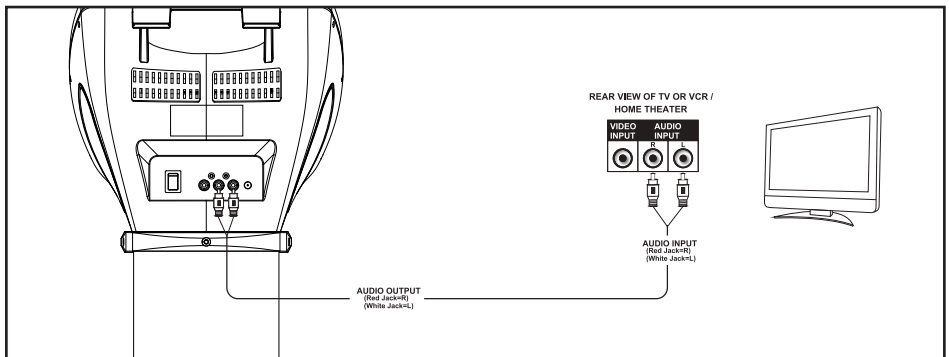

# MAKING THE CONNECTIONS

---

## SETTING UP LINE IN CONNECTION

The Line-in mode allows you to connect external music player or external sound source to your Karaoke Machine speakers

1. Plug a 3.5mm audio cable (not included) into your external music player and connect the other end (3.5mm jack) into the **LINE IN** jack on the front of your Karaoke Machine.
2. Make sure your external music is turned on.
3. Start music playback on your external music player.
4. Adjust **MASTER VOLUME** to control the sound level of music playback from the speakers on the Karaoke machine.

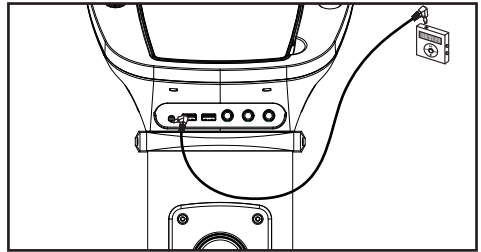

## SETTING UP YOUR MICROPHONE

1. Plug a microphone into the **MIC1** or **MIC2** jack at the front of your Karaoke Machine. Their output is mixed with playback from CD/CD+G.
2. Located on the microphone, there is an ON/OFF switch.
3. Ensure you set the ON/OFF switch on the microphone to ON when required for use.

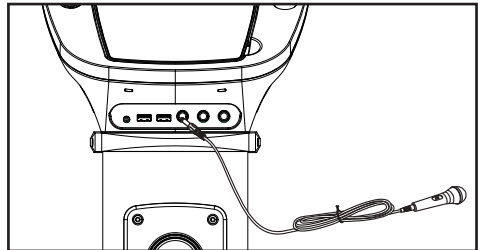

### **Warning:**

Please do not point the microphone head directly to the front of the speaker(s) on the unit when you are singing, it would cause unwanted feedback sound that may affect the performance of your unit.

Tapping or dropping the microphone while it is on can permanently damage your microphone. Resist the urge to swing the microphone around by the cord!

VHF wireless microphones are not recommended to work with this Karaoke system. Some VHF wireless microphones may cause unwanted noise and interference.



# CD OR CD+G / MP3+G OPERATION

This unit is designed to play CDs/CD+G/MP3/MP3+G disc bearing the identification logo respectively. If the disc does not conform to the standard, it may not play properly.



**NOTE:** The unit may not be able to read CDR or CDRW disc correctly. The readability depends on the quality of recording produced by CD recorder or CD writer.

## TURNING POWER ON/OFF

1. To turn on the **Karaoke Machine**, switch the POWER button at the back to ON. Press the STANDBY  button once, the POWER indicator will light up to full brightness and TFT screen will display the OPENING SCREEN and start to read CD. (If no disc is loaded, it will display “NO DISC”)
2. To turn off the system, press the **STANDBY**  button again. The power indicator and TFT screen will turn off. Switch the POWER button at the back to OFF to cut off the power.



## LOADING A DISC

1. Press FUNCTION button to toggle CD mode.
2. Open the CD door, place a disc in the CD compartment with the printed side facing down.
3. Gently close the CD Door to the CD compartment. The Karaoke Machine begins to read the disc and “READ” will be displayed. After that, the operation icon will appear on the top of the TFT screen.
4. Press **PLAY/PAUSE** to play the disc. (If no disc is loaded, it will display “NO DISC”)

## PLAY/PAUSE

1. To start playing, press the **PLAY/PAUSE** button once, the currently track number and PLAY indicator will appear on the screen.
2. To temporarily stop playing, press the **PLAY/PAUSE** button, the PAUSE indicator will be shown on the screen.
3. To resume play, press the PLAY/PAUSE button again, the PLAY indicator will be shown on the screen.

**NOTE:** - *Pressing pause when a CD+G/MP3+G is playing may cause distorted lyrics on the screen, any distortion will remain until the whole screen is refreshed during an instrumental break or you stop the song and start it from the beginning*

- *Never place anything except a compact disc on the disc compartment. Foreign objects can damage the unit.*
- *Do not apply excessive force to disc cover.*
- *Only place one disc on the disc compartment at a time.*
- *Do not open the disc cover of the CD compartment while it's playing.*

## STOP

If the **STOP** button is pressed in the course of playing, the disc will cease to play.

## SKIP PLAY (For both CD and CD+G/MP3+G discs)

In stop or playback mode, you can skip up or down to a specific track by pressing the forward or back SKIP Button.

# CD OR CD+G / MP3+G OPERATION

---

## SEARCH (For CD disc /MP3 disc only)

When playing a CD disc or MP3 disc, you can press and hold the **SKIP** buttons (**◀◀** or **▶▶**) to locate a specific point on a track. The system will search at high speed in the forward or reverse direction. By releasing the button, normal play will be resumed.

## REPEAT PLAY (For both CD and CD+G/MP3+G discs)

1. During playback, press **PROGRAM/REPEAT** button once, the repeat one indicator will appear on the TFT screen, it can keep repeat the current track.
2. To repeat the Directory/Folder, press **PROGRAM/REPEAT** button twice, the repeat folder indicator will appear on the TFT screen.
3. To repeat all tracks in disc, press **PROGRAM/REPEAT** button again, the repeat all indicator will appear on the TFT screen.
4. To clear the REPEAT function, press **PROGRAM/REPEAT** button again.

## PROGRAMMING CD PLAYBACK

This unit can be programmed to play up to 20 tracks/files in CD mode. Load the music CD/CD+G or MP3/MP3+G disc into the CD compartment (without pressing the **PLAY/PAUSE** button).

- 1) Press **PROGRAM/REPEAT** button once in stop mode. "PRG SET 01:XX" will be shown on the screen.
- 2) Press the **SKIP** buttons to select the desired track to be programmed.
- 3) Press **PROGRAM/REPEAT** button again to save the selected track/files.
- 4) Repeat steps 2–3 to program up to 20 tracks/files.
- 5) Press the **PLAY/PAUSE** button to play the programmed tracks after programming is completed. The "PROG" indicator will appear on screen during the programmed playback.
- 6) To clear program and resume normal playback, press the **STOP** button twice during playback, or open the CD door to clear the programmed tracks.

## REMARK:

*The unit can store up to 20 tracks/files in the programmable memories. During the programmed playback, user can still select the "repeat one/repeat all" function.*

## KEY+ / KEY-

Your system includes a digital key controller to adjust the audio tone (pitch) of the music. Key control should be done in the PLAY MODE only.

Press the **KEY+** button to raise the key of the music, and press the **KEY-** button to lower the key. (max. 6 times)

## PAGE+ / PAGE-

During the STOP mode, press PAGE+/PAGE- to advance song selection by 10 tracks or to go to the next page of song list.

# CD OR CD+G / MP3+G OPERATION

---

## **ECHO**

Adjust the **ECHO** control to enhance your voice for a concert hall effect.

## **BALANCE**

Adjust the **BALANCE** control between the pre-recorded singer's voice and the music when using a multiplex karaoke disc.

## **AUTO VOICE CONTROL**

AUTO VOICE CONTROL can be activated and adjusted by the **AVC** control knob. The vocals on the Multiplex recording will be muted when the singer starts to sing through the microphone. When the singer stops singing, the vocals will resume to normal.

## **MASTER VOLUME**

Rotate to the **MASTER VOLUME** control to obtain the desired sound level.

## **MIC VOLUME**

Adjust the **MIC VOLUME** control to a desired level and obtain the best performance.

## **RANDOM**

Press **RANDOM** button to start playback CD/CDG randomly. Press **RANDOM** button again to go back to normal playback.

## **SCREEN ON/OFF**

Press the **SCREEN ON/OFF** button to turn the TFT screen ON/OFF.

## **SELECTING THE AUDIO SOURCE**

Press **FUNCTION** button to toggle between CD, USB 1, USB 2, Bluetooth and Line in mode.

**Note:** Selecting the audio source should be done in the stop mode only.

## **LIGHT EFFECT**

Press **LIGHT ON/OFF** button once to switch on LED light effect. Press the button again to switch off.

# USB OPERATION

---

## INSERTING USB FLASH DRIVE

1. Insert a USB flash driver into the USB socket on the front of your karaoke system. There are TWO USB in this machine - USB 1 & USB 2. Both of them can play MP3 and MP3G files.
2. Make sure that the correct USB is selected. Press FUNCTION button to toggle to USB 1 or USB 2.
3. Press PLAY/PAUSE to start playback.

## PLAY/PAUSE

1. To start playing, press the **PLAY/PAUSE** button once, the currently track number and PLAY indicator will appear on the screen.
2. To temporarily stop playing, press the **PLAY/PAUSE** button, the PAUSE indicator will be shown on the screen.
3. To resume play, press the PLAY/PAUSE button again, the STOP indicator will be shown on the screen.

**NOTE:** - *Pressing pause when playing on the MP3+G, it may cause distorted lyrics on the screen, any distortion will remain until the whole screen is refreshed during an instrumental break or you stop the song and start it from the beginning*

## STOP

If the **STOP** button is pressed in the course of playing, the MP3+G playback will cease to play.

## SKIP PLAY

In stop or playback mode, you can skip up or down to a specific track by pressing the forward or back **SKIP** Button.

## PAGE+ / PAGE-

During the STOP mode, press PAGE+/PAGE- to advance song selection by 10 tracks or to go to the next page of song list.

## SEARCH (For MP3 file only)

When playing a MP3 file on the USB, you can press and hold the SKIP buttons (**◀◀SKIP▶▶**) to locate a specific point on a track. The system will search at high speed in the forward or reverse direction. By releasing the button, normal play will be resumed.

## RANDOM

Press RANDOM button to start playback USB randomly. Press RANDOM button again to go back to normal playback.

## REPEAT PLAY

1. During playback, press **PROGRAM/REPEAT** button once, the repeat one indicator will appear on the TFT screen, it can keep repeat the current track.
2. To repeat the Directory/Folder, press **PROGRAM/REPEAT** button twice, the repeat folder indicator will appear on the TFT screen.
3. To repeat all tracks in disc, press **PROGRAM/REPEAT** button again, the repeat all indicator will appear on the TFT screen.
4. To clear the REPEAT function, press **PROGRAM/REPEAT** button again.

# USB OPERATION

---

## PROGRAMMING USB PLAYBACK

This unit can be programmed to play up to 20 files in USB mode. Plug the USB flash drive and select USB mode. (without pressing the **PLAY/PAUSE** button).

- 1) Press **PROGRAM/REPEAT** button once in stop mode. "PRG SET 00:XXX" will be shown on the screen.
- 2) Press the **SKIP** buttons to select the desired track to be programmed.
- 3) Press **PROGRAM/REPEAT** button again to save the selected track/files.
- 4) Repeat steps 2–3 to program up to 20 tracks/file.
- 5) Press the **PLAY/PAUSE** button to play the programmed tracks after programming is completed. The "PROG" indicator will appear on screen during the programmed playback.
- 6) To clear program and resume normal playback, press the **STOP** button twice during playback to clear the programmed tracks.

### REMARK:

*The unit can store up to 20 tracks/files in the programmable memories. During the programmed playback, user can still select the "repeat one/repeat all" function.*

## RECORDING IN USB 1

You can record your performance in different modes:

1. CDG mode - record CDG track with microphone voice & external input as MP3G.  
record CD or MP3 CD track with microphone voice & external input as MP3.
2. USB 2 mode - record MP3G or MP3 with microphone voice & external input as MP3
3. Bluetooth or Line-in mode - record music with microphone voice & external input as MP3

All recording files are stored in USB 1 flash drive under a folder named "REC". The following are the procedures for recording.

- Plug a USB flash drive into **USB 1** socket.
- Press **FUNCTION** button to toggle to mode you want to record - CDG/ USB2/ Bluetooth/ Line-in mode. Make sure that the corresponding music content is ready.
- Locate the desired track or file to play by pressing the **SKIP ►►** or **SKIP ◄◄** button  
Press **PLAY** button to start.
- Press **RECORD** button to start recording together with your voice and external input. (The percentage of completion will be displayed.)
- Press **RECORD** button again to stop recording.
- To playback the recording, it is the same as playing back the MP3 or MP3+G file on the **USB 1** flash drive, please follow instructions in USB OPERATION.



# **BLUETOOTH OPERATION**

---

## **BLUETOOTH SETUP**

Pairing is the term used when two Bluetooth devices are connected wirelessly for the first time.

1. Press **FUNCTION** button to toggle to Bluetooth mode.
2. The Bluetooth indicator will flash quickly. If the unit does not automatically begin to pair, press and hold the **PAIR** button.
3. Using the native controls on your Bluetooth Device, select the "KS878BT" in your Bluetooth setting to pair.
4. When successfully paired, the Bluetooth indicator will stop flashing.  
*After initial pairing, the unit will stay paired unless unpaired manually by the user or erased due to a reset of the devices.*  
*If your device unpaired, follow the above steps again.*  
*If any pairing issues occur, un-pair the unit on your Bluetooth device and follow the above steps again.*

## **PLAYING MUSIC VIA BLUETOOTH**

1. Follow the instructions for Pairing a Bluetooth Device.
2. Use the native controls on the connected Bluetooth Device to select a track.
3. To play, pause or skip the selected track, use the native controls on the connected Bluetooth Device or press the **PLAY/PAUSE & SKIP** buttons of unit.
4. Audio playback from the connected Bluetooth device can now be heard through the speaker.

# **ENERGY SAVING (Auto Power System - APS)**

---

The unit will automatically turn to 'Standby' mode in 15 minutes in the following situations:

1. There is no CD in the compartment or CD had been stopped for playing when the source had been selected to CD.
2. There is no USB flash drive plugged in or USB flash drive had been stopped for playing when the source had been selected to USB.
3. There is no audio cable plugged into the LINE IN jack when the source had been selected to AUX.

The unit can be resumed to turn on by pressing the **STANDBY**  button once.

# CARE AND MAINTENANCE

---

## \*Carrying for Compact Discs

1. Treat the disc carefully. Handle the disc only by its edges. Never allow your fingers to come in contact with the shiny, unprinted side of the disc.
2. Do not attach adhesive tape, stickers, etc. to the disc label.

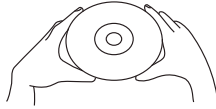

3. Clean the discs periodically with a soft, lint-free, dry cloth. Never use detergents or abrasive cleaners to clean the disc. If necessary, use a CD cleaning kit. If a disc skips or gets stuck on a section of the disc, it is probably dirty or damaged (scratched). When cleaning the disc, wipe in straight lines from the center of the disc to the outer edge of the disc. Never wipe in circular motions.

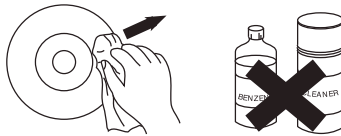

4. This unit is designed to play discs bearing the identification logo as shown here or MP3 format Disc. Other discs may not conform to the CD standard and may not play properly.
5. Discs should be stored in their cases after each use to avoid damage.
6. Do not expose discs to direct sunlight, high humidity, high temperatures, or dust, etc. Prolonged exposure or extreme temperatures can warp the disc.
7. Do not stick or write anything on either side of the disc. Sharp writing instruments or the ink may damage the surface.

## \*Care of the Cabinet

1. To prevent fire or shock hazard, disconnect your unit from the AC power source when cleaning.
2. The finish on your unit may be cleaned with a dust cloth and cared for as other furniture. Use caution when cleaning and wiping the plastic parts.
3. Mild soap and a damp cloth may be used on the front panel.

## \*To Clean the Lens

If the lens get dirty, your player may skip or may not play a CD

1. Open the CD door.
2. Use a camera lens blower/brush to blow on the lens once or twice, brush the dust or particles off the lens then blow again.
3. To remove fingerprints, use a dry cotton swab to wipe from the middle to outer edge of the lens.

# TROUBLE SHOOTING

PROBLEM	POSSIBLE CAUSE	SOLUTION
No power when POWER is on.	AC adaptor is not plugged into a wall outlet or the connector is not plugged into the power supply jack on the back of the unit.	Plug the AC adaptor into a wall outlet and plug the connector into the supply jack on the unit.
No power when plugged in.	The AC outlet may not have power.	Check the outlet with a working lamp or other electrical appliance.
No sound from TV.	TV system is set to minimum	Turn up the volume on the TV system
	TV system is powered Off	Power the TV system on.
	RCA cords are not connected securely.	Ensure white and red RCA cords are securely inserted into the karaoke system and the TV system.
CD Player does not work normally	Disc is inserted upside down	Insert the disc correctly
	Disc is dirty	Wipe clean with a soft cloth
	Disc is scratched	Use a new disc
	Disc is warped	Use a new disc
	A non standard disc is inserted	Only use discs bearing correct identification logo
	Moisture has formed inside the CD deck	Wait about 20 - 30 mins to let it dry out.
No sound - If audio is going through TV or VCR.	Karaoke system needs to be reset	Disconnect the machine from the power source for 30 seconds then reconnect
	Source Selection on TV or VCR is not correct.	Follow directions "Making the connections"
	RCA cords are not connected securely	Ensure white and red RCA cords are securely inserted into both the karaoke system and the home stereo system.

# TROUBLE SHOOTING

PROBLEM	POSSIBLE CAUSE	SOLUTION
No song lyrics appear on the TV screen	Video cable is not connected properly to the TV	Connect the video cable to the karaoke system's VIDEO OUT and to the TV VIDEO IN.
	Source selector on TV is not set to VIDEO	Using your TV remote to select VIDEO input or select the proper VIDEO input on the TV itself.
	TV does not have video line input	Connect from VIDEO OUT of the system to the VIDEO IN on your VCR/Home theater. Refer to "Making the Connections. Check the disc to be sure it is a CD+G
No sound from mic	Mic volume control is set to minimum	Adjust mic volume to max, and then re-adjust to a comfortable level
	Mic is off	Turn on mic with the ON/OFF switch located on the microphone
No Video is displayed on the TFT Screen.	The TFT screen is turned OFF.	Set screen button to turn ON.
	The disc being played is a regular music CD, in which case no image will be displayed.	Ensure you are playing a CD+Graphics or CD+G Karaoke disc.
No sound when playing audio via Bluetooth.	Your Bluetooth device hasn't been paired properly.	Pairing your Bluetooth device according to the "Bluetooth setup" section.
	The volume control of your Bluetooth device is set too low.	Increase the volume of your Bluetooth device.
	The volume control of your Bluetooth device is set too low.	Increase the volume of the unit by VOLUME control.

# SPECIFICATION

---

<b>Audio Section</b> Output power Output impedance	40W RMS Top speaker: 16 ohm Base speaker: 6 ohm
<b>CD OR CD+G player</b> Frequency response Signal - to - noise ratio Number of programs	100 Hz - 20 kHz 50 dB 20 STEPS RANDOM ACCESS PROGRAMMING
<b>Microphone</b>	-73 dB 600 OHMS IMPEDANCE WITH Ø 6.3mm DYNAMIC MICROPHONE

Specifications are typical, individual units might vary. They are subject to continuous improvement without notice and without incurring any obligation.

# **THE KARAOKE MACHINE (GLOSSARY OF TERMS)**

Following are some brief descriptions of karaoke terms you may need:

## **Echo:**

By adding some minor feedback to your voice the Echo feature adds depth and resonance to a singer's voice. Echo affects only your voice and not the music. It will make you sound like you are singing in a big concert hall.

## **Multiplex:**

This karaoke system is capable of playing Multiplex CD+G Karaoke discs. Multiplex Karaoke discs feature two mono versions of the same recording on left and right channels. The right channel features a mono version of the song with the lead vocals pre-recorded. The left channel features the same song, without the lead vocals recorded.

## **Auto Voice Control (A.V.C.):**

This is short for "Automatic Vocal Control". When the AVC knob on the front panel of the player is turned clockwise, the AVC function is activated. AVC is used to eliminate the singer's vocals from specially made Multiplex CD+G karaoke discs. Once the AVC is activated, as you sing into the microphone, the pre-recorded vocals are eliminated and replaced with your singing voice. Set the AVC to a lower setting, and you'll be able to hear the pre-recorded vocals in low volume as well as your own singing voice. Set the AVC to maximum and as you sing into the microphone, the pre-recorded lead vocals will be completely eliminated, and only your own singing voice will be heard.

NOTE: The AVC controls is only functional with specific Multiplex CD+G Karaoke Discs. AVC will not eliminate the vocals from standard music CDs, and will not function when playing standard Karaoke CD+G discs, such as the disc included with this system.

## **CD+G:**

This is short for Compact Disc plus Graphics. This is a regular audio CD with the lyrics stored in a data track. While your karaoke player will play regular audio CDs they will not have the background data track that will allow the lyrics to be displayed.