



singing machine®

creating Joy through music

SDL9030DB

INSTRUCTION MANUAL

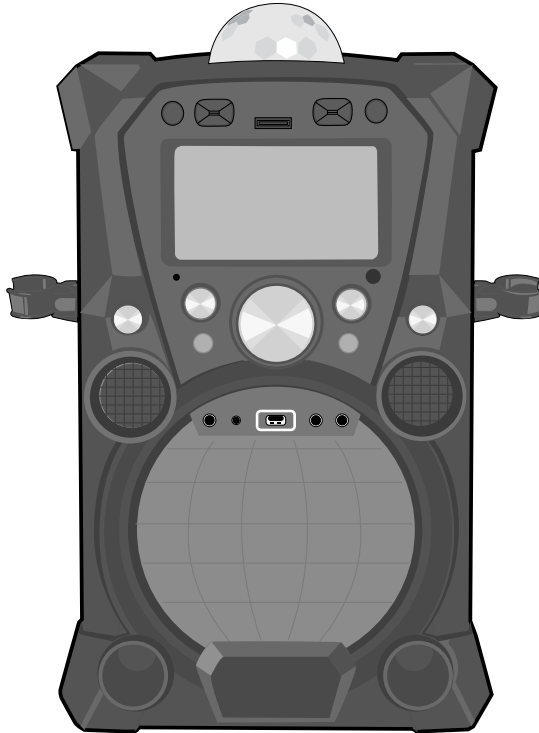

www.singingmachine.com

The Singing Machine® is a registered trademark of The Singing Machine Co., Inc.

Warnings

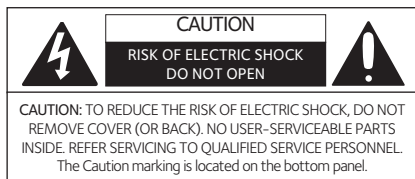

DANGEROUS VOLTAGE: The lightning flash with arrowhead symbol within an equilateral triangle is intended to alert the user to the presence of uninsulated dangerous voltage within the product's enclosure that may be of sufficient magnitude to constitute a risk of electric shock to persons.



ATTENTION: The exclamation point within an equilateral triangle is intended to alert the user to the presence of important operating and maintenance (servicing) instructions in the literature accompanying this product.

DRIPPING WARNING: This product shall not be exposed to dripping or splashing, and no objects filled with liquids, such as vases, shall be placed on the product.

VENTILATION WARNING: The normal ventilation of the product shall not be impeded for intended use.

CAUTION: TO PREVENT ELECTRIC SHOCK, MATCH WIDE BLADE OF PLUG TO WIDE SLOT AND FULLY INSERT.

CAN ICES-3(B)/NMB-3(B)

Le présent appareil est conforme aux CNR d'Industrie Canada applicables aux appareils radio exempts de licence. L'exploitation est autorisée aux deux conditions suivantes:

- (1) l'appareil ne doit pas produire de brouillage, et
 - (2) l'utilisateur de l'appareil doit accepter tout brouillage radioélectrique subi, même si le brouillage est susceptible d'en compromettre le fonctionnement.
- Cet équipement doit être installé et utilisé à une distance minimale de 20 cm entre le radiateur et votre corps.

WARNING: TO PREVENT FIRE OR SHOCK HAZARD, DO NOT EXPOSE THIS UNIT TO RAIN OR MOISTURE.

FCC WARNING: This equipment may generate or use radio frequency energy. Changes or modifications to this equipment may cause harmful interference unless the modifications are expressly approved in the instruction manual. The user could lose the authority to operate this equipment if an unauthorized change or modification is made.

This device complies with part 15 of the FCC Rules. Operation is subject to the following two conditions: (1) This device may not cause harmful interference, and (2) this device must accept any interference received, including interference that may cause undesired operation.

NOTE: This equipment has been tested and found to comply with the limits for a Class B digital device, pursuant to part 15 of the FCC Rules. These limits are designed to provide reasonable protection against harmful interference in a residential installation. This equipment generates, uses and can radiate radio frequency energy and, if not installed and used in accordance with the instructions, may cause harmful interference to radio communications. However, there is no guarantee that interference will not occur in a particular installation. If this equipment does cause harmful interference to radio or television reception, which can be determined by turning the equipment off and on, the user is encouraged to try to correct the interference by one or more of the following measures:

- Reorient or relocate the receiving antenna.
- Increase the separation between the equipment and receiver.
- Connect the equipment into an outlet on a circuit different from that to which the receiver is connected.
- Consult the dealer or an experienced radio/TV technician for help.
- The rating information is located at the bottom of the unit.

INDUSTRY CANADA NOTICE:

This device complies with Industry Canada licence-exempt RSS standard(s).

Operation is subject to the following two conditions: (1) This device may not cause interference, and (2) This device must accept any interference, including interference that may cause undesired operation of the device.

This equipment should be installed and operated with a minimum distance of 20 cm between the radiator and your body.

Important Safety Instructions

1. Read these Instructions.
2. Keep these Instructions.
3. Heed all Warnings.
4. Follow all Instructions.
5. Do not use this apparatus near water.
6. Clean only with a dry cloth.
7. Do not block any of the ventilation openings. Install in accordance with the Manufacturer's instructions.
8. Do not install near any heat sources such as radiators, heat registers, stoves, or other apparatus (including amplifiers) that produce heat.
9. Do not defeat the safety purpose of the polarized or grounding-type plug. A polarized plug has two blades with one wider than the other. A grounding type plug has two blades and a third grounding prong. The wide blade or the third prong are provided for your safety. When the provided plug does not fit into your outlet, consult an electrician for replacement of the obsolete outlet.
10. Protect the power cord from being walked on or pinched particularly at plugs, convenience receptacles, and the point where they exit from the apparatus.
11. Only use attachments/accessories specified by the manufacturer.
12. Use only with a cart, stand, tripod, bracket, or table specified by the manufacturer, or sold with the apparatus. When a cart is used, use caution when moving the cart/apparatus combination to avoid injury from tip-over.
13. Unplug this apparatus during lightning storms or when unused for long periods of time.
14. Refer all servicing to qualified service personnel. Servicing is required when the apparatus has been damaged in any way, such as power-supply cord or plug is damaged, liquid has been spilled or objects have fallen into the apparatus, the apparatus has been exposed to rain or moisture, does not operate normally, or has been dropped.
15. **WARNING:** To reduce the risk of fire or electric shock, do not expose this apparatus to rain or moisture. Do not place objects filled with water, such as a vase, on the apparatus.
16. The AC mains plug is used as the power disconnect device and it should remain readily accessible and operable during intended use. In order to completely disconnect the apparatus from power, the mains plug should be completely removed from the AC outlet socket.
17. **CAUTION:** To reduce the risk of fire or explosion, do not expose batteries to excessive heat such as sunshine, fire or other heat sources.

PORTABLE CART WARNING
(symbol provided by RETAC)



Included

Please make sure the following items are included.

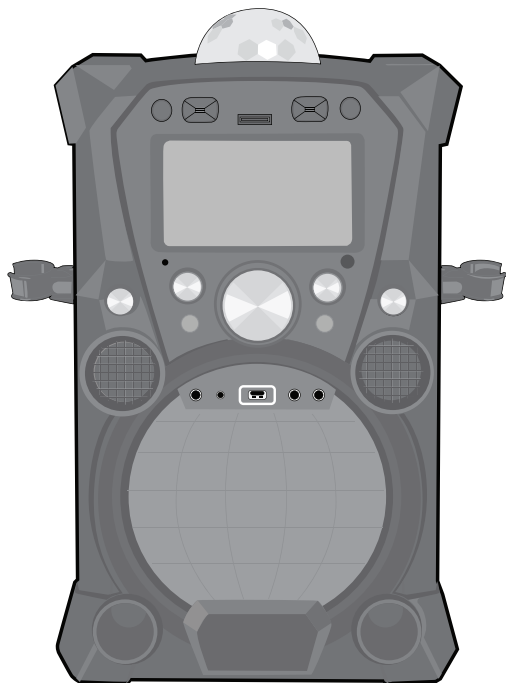

Main Unit



Wired Interactive Microphone



Wired Microphone

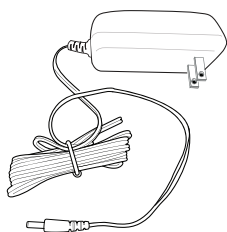

AC Adapter

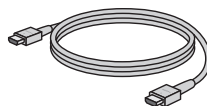

HDMI Cable



Manual



Singing Machine Flash Drive

Location of Controls (Top/Front)

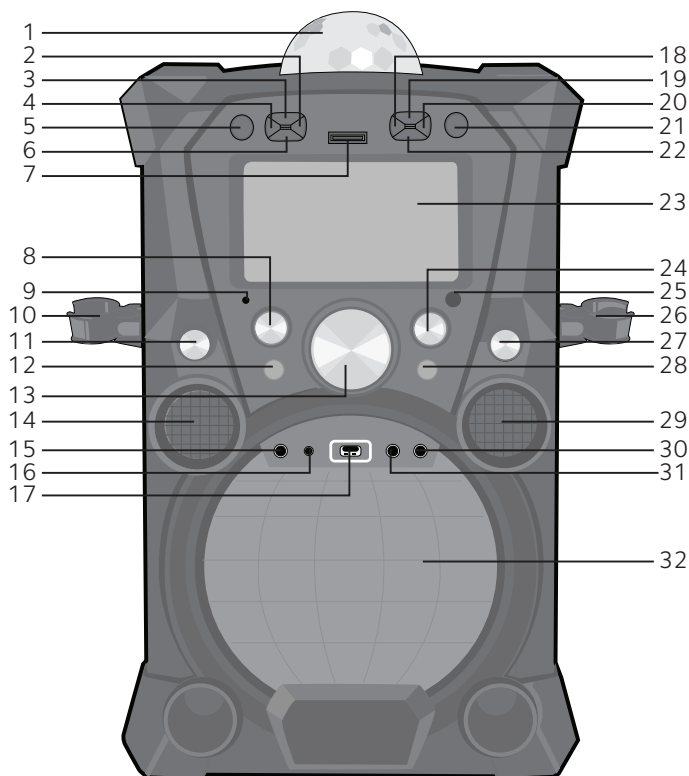

- | | |
|-------------------------------------|-------------------------------|
| 1. Disco Ball | 17. SMC USB Slot |
| 2. MENU Button | 18. Navigation LEFT ◀ Button |
| 3. FUNCTION (Monitor ON/OFF) Button | 19. Navigation UP ▲ Button |
| 4. VOCAL/PAIR Button | 20. Navigation RIGHT ▶ Button |
| 5. ON/OFF Button | 21. ENTER/▶ Button |
| 6. RECORD ● Button | 22. Navigation DOWN ▼ Button |
| 7. SD Card Slot (for Record only) | 23. TFT LCD Color Screen |
| 8. MIC 1 VOLUME Control | 24. MIC 2 VOLUME Control |
| 9. Bluetooth Indicator | 25. Remote Sensor |
| 10. MIC 1 Holder | 26. MIC 2 Holder |
| 11. EXTERNAL INPUT VOLUME Control | 27. ECHO Control |
| 12. DISCO BALL Button | 28. LIGHT MODE Button |
| 13. MASTER VOLUME Control | 29. Tweeter |
| 14. Tweeter | 30. MIC 2 Jack |
| 15. EXTERNAL INPUT Jack | 31. MIC 1 Jack |
| 16. LINE IN Jack | 32. Speaker/Lights |

Location of Controls (Rear)

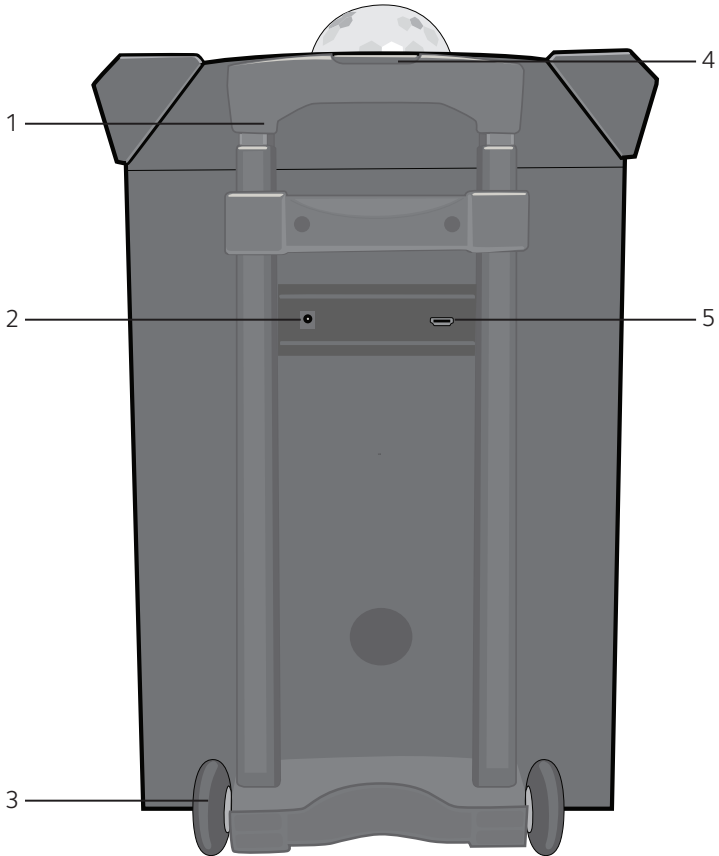

- 1. Adjustable Handle
- 2. DC IN Jack
- 3. Wheels

- 4. Handle Release
- 5. HDMI Jack

Location of Controls (Microphones)

Interactive Microphone

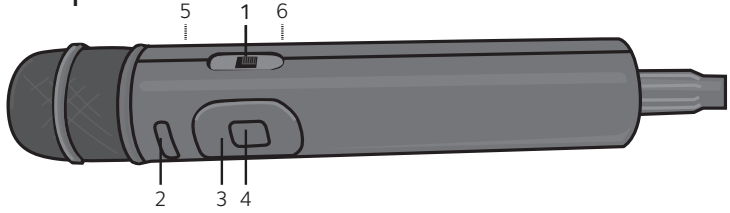

Standard Microphone

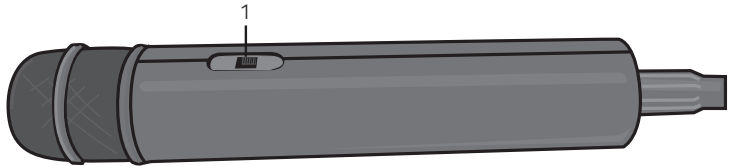

- | | |
|-----------------------|-------------------------------|
| 1. Mic ON/OFF Switch | 4. ENTER/▶ Button |
| 2. MENU Button | 5. Remote Transmitter (Rear) |
| 3. Navigation Buttons | 6. Battery Compartment (Rear) |

Location of Controls (Playback Display)

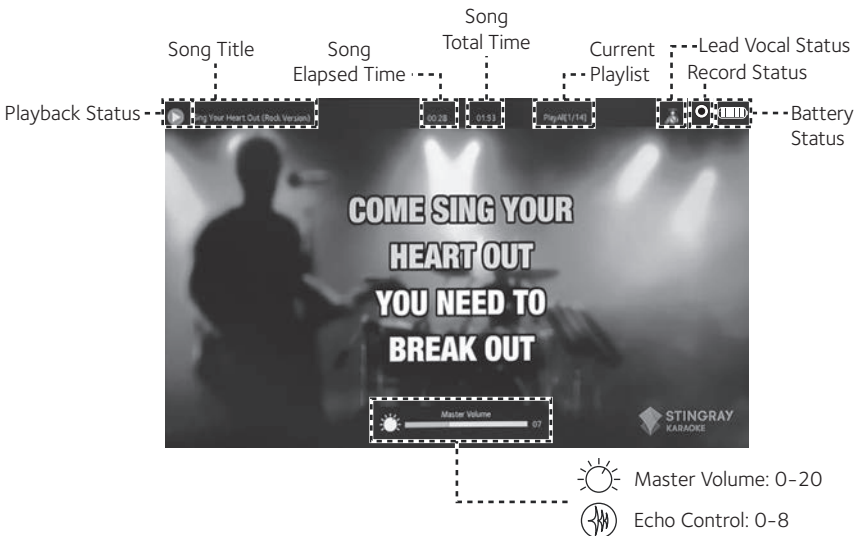

Connection

Connecting the Microphone(s)

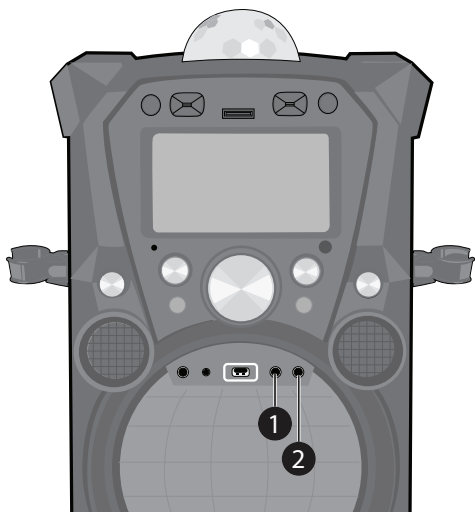

Microphones:

Connect a microphone into Mic jack 1 **1** and the other microphone into Mic jack 2 **2** (if desired).

Note: Do not drop or tap the Mic as damage to the Mic or speakers may occur. Do not twirl the microphone by cord as it will cause damage to the encased wiring.

Connection

Connecting the Unit to a TV

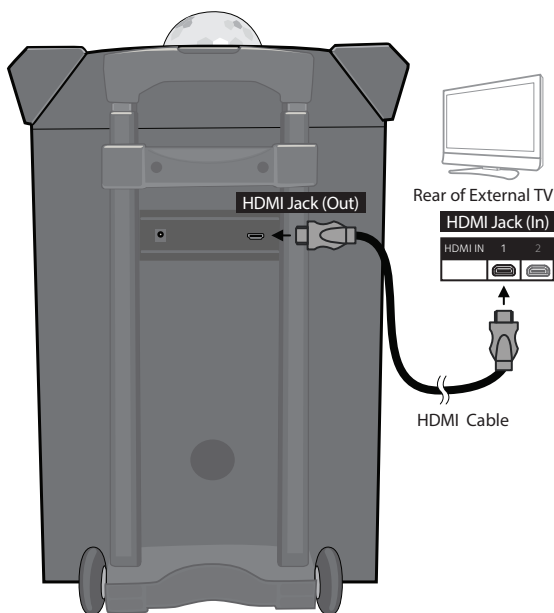

The video and lyrics will be displayed on the built-in screen. You may also want to connect a TV to display a larger image and additional sound; follow the steps below:

Plug the HDMI cable (included) into the HDMI Jack on the back of the unit. Plug the other end of the HDMI cable into the HDMI input on your TV.

Notes:

- This unit can be used with or without a TV.
- Also refer to the TV's or external unit's User Guide.

Connection

Connecting to AC Power

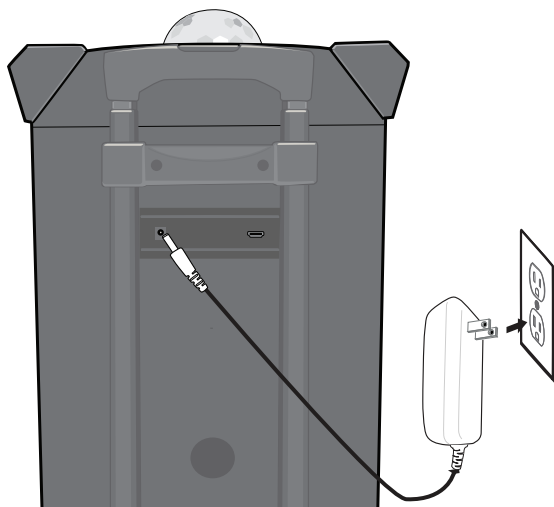

- 1 Insert the AC power cord into a conveniently located AC outlet having 120V AC, 60Hz.

Note:

Make all connections before connecting to AC power.

Changing the Interactive Microphone's Battery



When performance suffers, change the batteries as follows:

- 1 Unscrew the Battery Compartment screw and remove the door.
- 2 Replace battery with CR2025 button cell battery.
- 3 Replace Battery Compartment and screw.

BATTERY PRECAUTIONS:

Follow these precautions when using batteries in this device:

1. Warning – Danger of explosion if battery is incorrectly replaced. Replace only with the same or equivalent type.
2. Use only the size and type of batteries specified.
3. Be sure to follow the correct polarity when installing the batteries as indicated in the battery compartment. A reversed battery may cause damage to the device.
4. If the device is not to be used for a long period of time, remove the batteries to prevent damage or injury from possible battery leakage.
5. Do not try to recharge a battery not intended to be recharged; it can overheat and rupture. (Follow battery manufacturer's directions.)
6. Remove batteries promptly if consumed.

Rechargeable Battery

This unit comes with a built-in rechargeable battery pack that will allow the unit to be used without being connected to AC power. The Battery indicator (top right of the display) will show the battery charge left, indicated by the amount of bars. The rechargeable battery pack is not user-replaceable.

When the battery icon turns red, recharge the unit by following below:

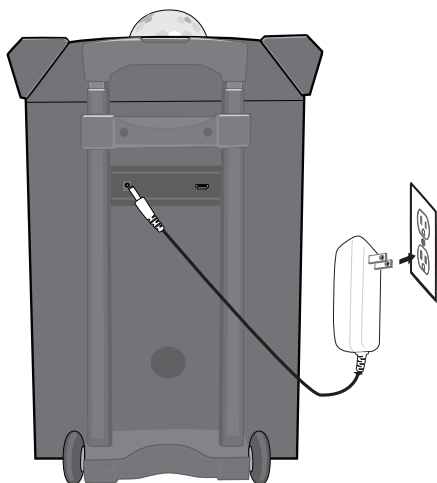

- 1 Insert the AC power cord into a conveniently located AC outlet having 120V AC, 60Hz .
- 2 Allow the unit to charge for approximately twelve hours for a full charge.
- 3 Disconnect the AC cord and the fully charged unit can be used for approximately eight hours.

Recycling and Disposal Information:

- Do not dispose of electronic devices or any of their components (especially batteries and LCD displays) in your municipal trash collection.
- Consult your local waste management authority or a recycling organization like Earth911.com to find an electronics recycling facility in your area.



CAUTION: Rechargeable batteries must be recycled or disposed of properly.

Lithium-Polymer Battery Warning

- This equipment contains a rechargeable lithium-polymer battery.
- Do not charge the battery in temperatures below 32° F (0° C) or higher than 113° F (45° C).
- Do not open or mutilate the battery.
- The rechargeable batteries contained in this equipment may explode if disposed of in a fire.
- Do not short-circuit the battery.
- Do not charge the rechargeable battery pack used in this equipment with any charger other than the one designed to charge this battery pack, as specified in the owner's manual. Using another charger may damage the battery pack or cause the battery pack to explode.

Singing Machine USB Flash Drive



Included with the system is a **Singing Machine USB Flash Drive**, which is used for storing Karaoke songs as well as recordings from this unit.

There are two songs included on the **Singing Machine USB Flash Drive**, but you can access the Karaoke Store for many more songs. Just follow the Welcome Kit Instructions!

Inserting the USB Flash Drive or an SD Card

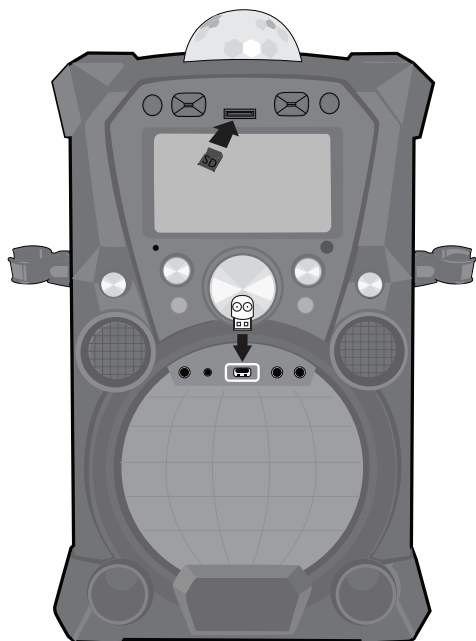

Before you insert the **Singing Machine USB Flash Drive**, make sure to remove it from its stand which will reveal the USB plug.

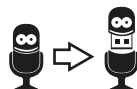

Insert it into the USB slot on the unit with the face towards the top of the unit. If you would like to have more memory capacity for the recording function, you can insert an SD Card with up to 32 GB (not included) to store the recorded files as well.

Note: If both an SD Card and a USB Flash Drive are inserted, the unit will automatically record onto the SD card.

Karaoke Store

PC Installation

The Karaoke Store application can be installed on Microsoft Windows computers running Vista, Windows 7, and Windows 8 or higher. The Karaoke Store application requires connection to the Internet (a high-speed connection is recommended).

1 Insert the **Singing Machine USB Flash Drive** into a powered USB slot on your computer.



2 Double-click the file named, “Karaoke_Store_Win_Setup”.

3 Follow the online instructions to install the software on your computer.



4 After installing, open your Program’s folder and open the **Karaoke Store** folder.

5 Double-click “Karaoke Store” to open the software.

6 On this page you can now sign up and enter your code for ten free downloads and then download them to your computer and/or USB drive for playing on your new Singing Machine!

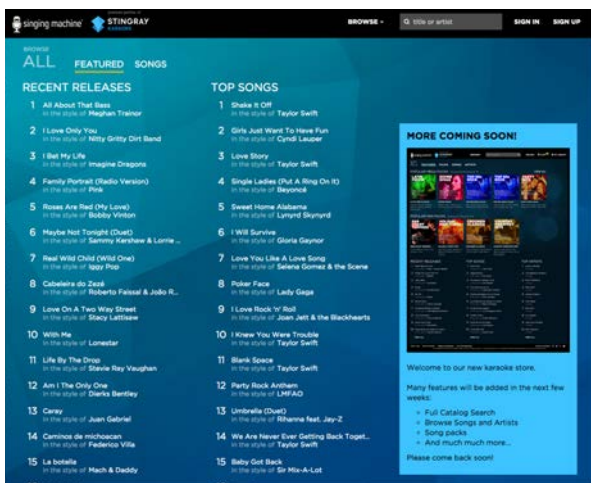

Karaoke Store

Mac Installation

The Karaoke Store application can be installed on Apple Macintosh computers running OS X 10.8 and higher. The Karaoke Store application requires connection to the Internet (a high-speed connection is recommended).

1 Insert the **Singing Machine USB Flash Drive** into a powered USB slot on your computer.

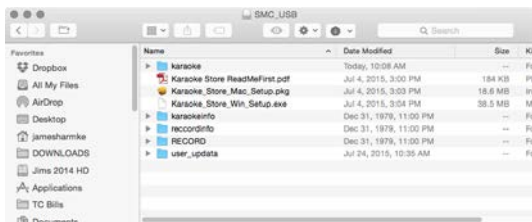

2 Double-click the file named, "Karaoke_Store_Mac_Setup.pkg".

3 Follow the online instructions to install the software on your computer.

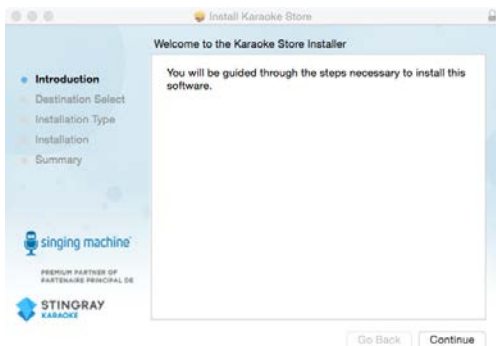

4 After installing, open your Application's folder and open the **Stingray Karaoke Store** folder.

5 Double-click Karaoke Store App to open the software.

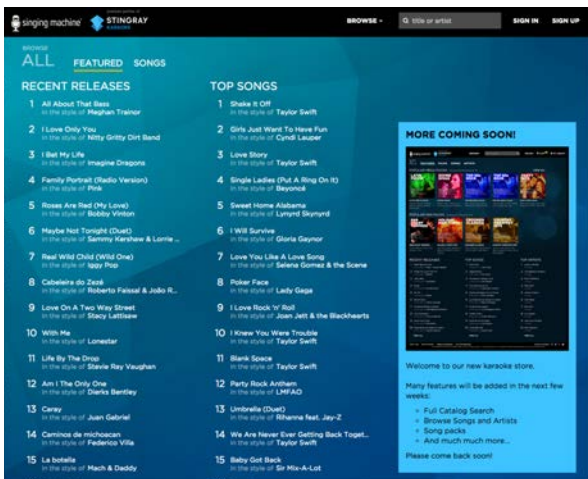

6 On this page you can now sign up and enter your code (located in your welcome kit) for ten free downloads and then download them to your USB drive for playing on your new Singing Machine!

Operation

Microphone Remote Operation

The Microphone is also a remote control that can be used to control the unit. See below for instructions on using the Microphone Remote.

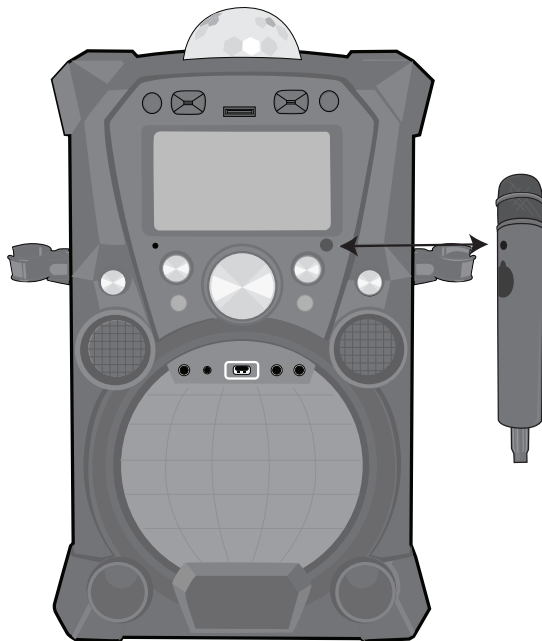

It is very important to point the remote's sensor at the unit's remote sensor (see illustration).

This Microphone Remote's buttons will operate the same way as the main unit's ENTER, Navigation and MENU buttons. When a step says to press one of these buttons, you can use either the unit or the Microphone Remote.

To turn the Microphone On, slide the ON/OFF switch **1** to the ON position.

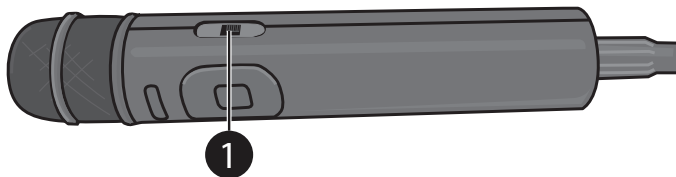

Operation

Light Mode

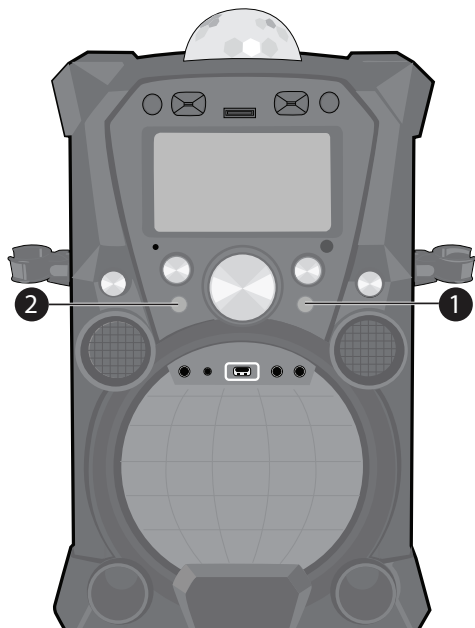

1 There are four Light modes. Repeatedly press the LIGHT MODE button to select a mode as follows:

Light Mode 1: The unit will light up with random colors and patterns.

Light Modes 2 and 3: The unit will synchronize to the music being played or the live singing performance. As the volume of the music/singing increases the brighter the lights become.

Light Mode 4: The light effects will be turned off.

2 This unit also comes with a Disco Ball feature. Press the DISCO BALL button to turn the lights on and they will illuminate onto the ceiling.

Power Save Mode

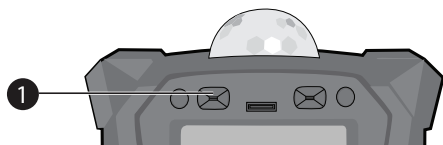

To save the battery power of the unit when you are outdoor, press and hold the FUNCTION button.

Carrying Handle

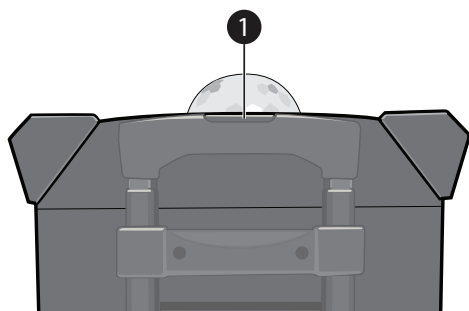

To extend the Adjustable Handle, simply press the Handle Release 1 and extend the Adjustable Handle as desired.

To slide the Adjustable Handle back, press the Handle Release again and slide it downward.

Operation

Playing Songs from the USB

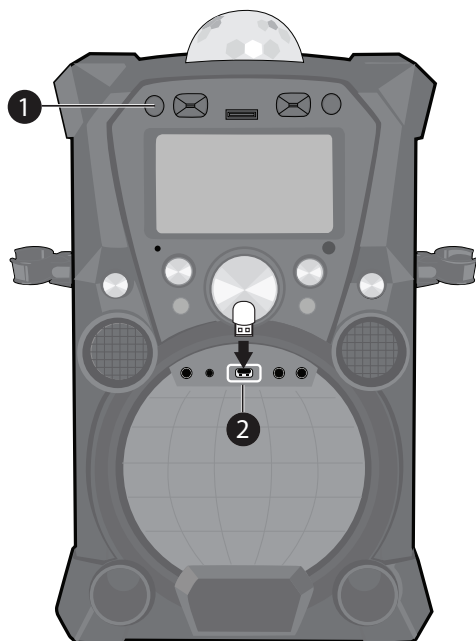

1 Connect the unit as described previously. Press the **ON/OFF** button to turn the unit on.

2 Remove the provided Singing Machine flash drive from its stand to reveal the USB plug. Insert it into the USB slot on the unit so it faces upward.



Note: The Singing Machine flash drive has an 8 GB capacity (the actual capacity may vary slightly).



3 The USB mode will be selected by default; press the **ENTER ►||** button to enter the USB mode. You can also repeatedly press the **FUNCTION** button to select the USB mode.

Notes:

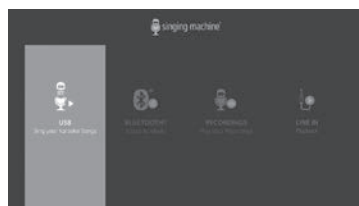

- The USB mode cannot be accessed until a flash drive is inserted.
- A loading icon will appear on the external screen when the system is loading the songs.

Operation

Playing Songs from the USB (Continued)



- 4 Use the **Navigation** ▲ Up and ▼ Down buttons to navigate through the list of songs that you have previously downloaded on your USB.



- 5 Press the **ENTER** ►||| button to start the playback. The HD karaoke video will play on the screen. Press the **ENTER** ►||| button during playback to pause the song. Press the **MENU** button to stop the playback and go back to the USB menu.

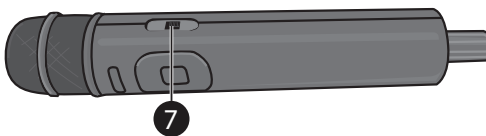

- 6 Adjust the volume to a comfortable level using the **MASTER VOLUME** control.

Notes:

- If connected to a TV, there will be no display on the built-in monitor.
- If connected to a TV, you can also control the volume with the TV's volume control.

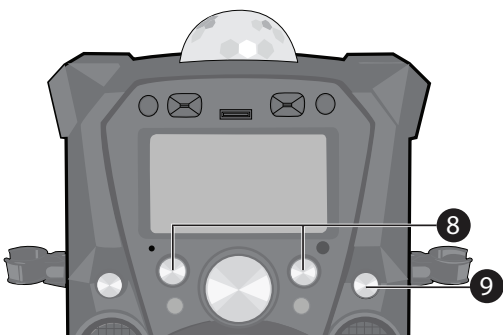

- 7 Connect the microphone(s) as shown on page 6. Slide the Remote/Mic's **ON/OFF** switch to the ON position.



- 8 Adjust the **MIC VOLUME 1** or **2** control as desired. Increasing this will increase the volume of the respective microphone.

- 9 Rotate the **ECHO** control to add an echo effect to your voice. Rotate towards **MAX** to increase the echo effect.

Operation

Playing Songs from the USB (Continued)



- 10** **VOCAL:** To sing with the lead singer on the recording, press the **VOCAL/PAIR** button; “” will appear at the top right of the monitor. To listen to music only, press the **VOCAL/PAIR** button again; “” will appear over the Lead Vocal Status icon.

Note: The song must be recorded with separate vocals that is downloaded (aka multiplex recording) in order to utilize the Lead Vocal function.

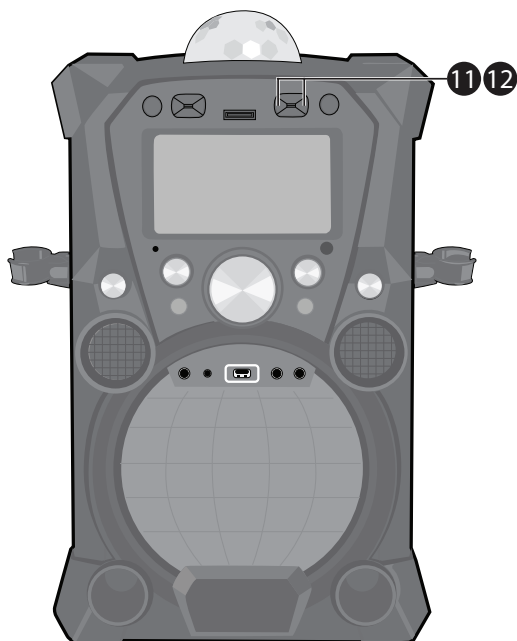

- 11** **SKIP:** Advance or go back one track by pressing the **Navigation** ▶ Right or ◀ Left button.

- 12** **TO ADVANCE ON THE TRACK:** During playback, press and hold the **Navigation** ▶ Right or Left ◀ button to move forward or backward. When you release the button, normal playback will resume.

Operation

Playing Songs from the USB (Continued)

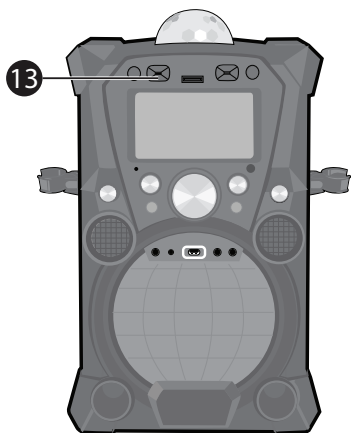

- 13 RECORDING YOUR SINGING:** To record your singing as well as the music, press the **RECORD** button; recording will begin and the record icon at the top right corner of the monitor will blink red. When done recording, press the **RECORD** button again; the Record icon will stop blinking red.

Notes:

- If an SD card is installed, the recorded audio file will record on it. If no SD card is present, the recorded audio file will record onto the USB drive.
- The recorded audio file will be named starting with the Karaoke song title.
- See page 24 to play back your recorded files.

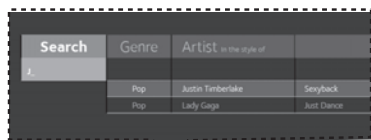
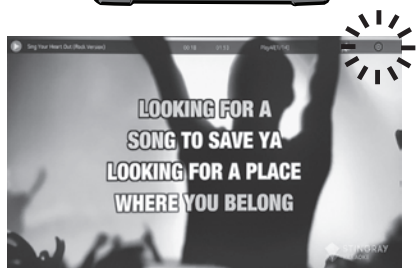

- 14 SEARCHING BY ARTIST OR TITLE:** While in the USB menu, select **Search** using the **Navigation** ◀ Left and ▶ Right buttons, then press the **ENTER** ►||| button. The alphabet will appear at the bottom of the screen. Select the desired starting letter using the **MASTER VOLUME** control, then press the **ENTER** ►||| button to select it. A list of songs that meet the criteria will appear. Use the **Navigation** ▲ Up and ▼ Down buttons to navigate through the list of songs, then press the **ENTER** ►||| button to play your selection, or select the next letter the same way.

Note:

You can search up to six letters; after the sixth letter the search will reset.

Operation

Playing Songs from the USB (Continued)



15 SEARCHING BY GENRE, ARTIST or TITLE: To filter by Genre, Artist or Title, select the **Genre**, **Artist**, or **Title** using the **Navigation** ◀ Left and ▶ Right buttons, then press the **ENTER** ►||| button. The alphabet will appear at the bottom of the screen; select the desired starting letter using the **MASTER VOLUME** control, then press the **ENTER** ►||| button to select it. A list of songs that meet the criteria will appear. Use the **Navigation** ▲ Up and ▼ Down buttons to navigate through the list of songs, then press the **ENTER** ►||| button to play your selection, or select the next letter the same way.

Note:

You can search up to six letters. After the sixth letter the search will reset.

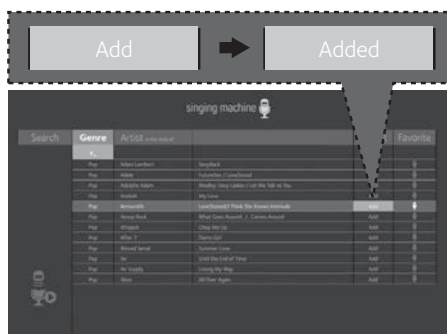

16 CREATING THE PLAYLIST: To create a personalized playlist, select a song using the **Navigation** ▲ Up and ▼ Down buttons, then scroll to the **Playlist** column (**Add**) using the **Navigation** ▶ Right or ◀ Left button. Press the **ENTER** ►||| button to confirm the operation; “Added” will appear. Repeat this step to add more songs.

Notes:

- The personalized Playlist will be kept even if the unit is turned on or off.
- You can always edit your Playlist after you create it by selecting a song that was added and pressing the **ENTER** ►||| button again; “Added” will change to “Add”.

Operation

Playing Songs from the USB (Continued)

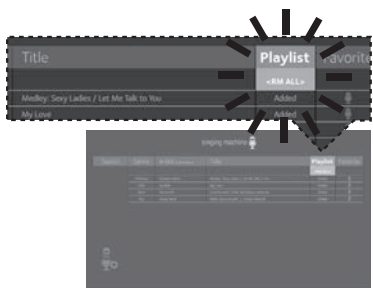
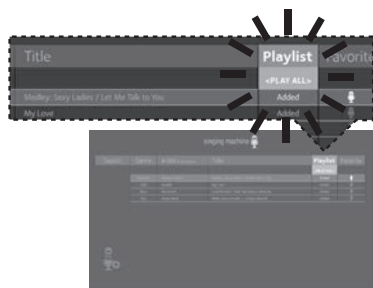

17 USING THE PLAYLIST: To play your previously created playlist, select **Playlist** using the **Navigation** ▶ Right and ◀ Left buttons, then press the **ENTER** ▶||| button; the row under Playlist will be highlighted. Select the desired selection using the **Navigation** ▶ Right and ◀ Left buttons as follows: **TO PLAY ALL:** Select **Play All** and then press the **ENTER** ▶||| button to play back all of the Playlist songs. (See below to add favorites.)

PRIORITY:

- Select priority and then navigate down to the song you want to prioritize.
- Press the **Navigation** ▶ Right button and the numbers will change to 0001, 0002, etc. According to the numbers displayed the songs will be listed in that order from top to bottom.
- After setting all songs on your priority list, press the **MENU** button then the playlist will be highlighted.
- Use the **Navigation** ▼ Down button to select the first song and press the **ENTER** ▶||| button to start the playback of all songs on the play list.
- To change the Priority list, navigate up and down to select the songs you want to play in the order you desire.

REMOVE: Select **Remove** and then select a song to remove using the **Navigation** ▲ Up and ▼ Down buttons. Press the **ENTER** ▶||| button; the song will be deleted from the playlist.

RM ALL: To remove the whole Playlist, select **RM ALL** and then press the **ENTER** ▶||| button; the whole Playlist will be deleted.

Operation

Playing Songs from the USB (Continued)



18 CREATING FAVORITES: To create a favorite playlist, select a song using the **Navigation** ▲ Up and ▼ Down buttons, then scroll to the **Favorite** column using the **Navigation** ► Right or ◀ Left button. Press the **ENTER** ►||| button to confirm the operation; the icon will turn from white to blue. Repeat this step to add more songs.

Notes:

- The Favorites will be stored even if the unit is turned on or off.
- You can always edit Favorites after you create them by selecting a song that was added and pressing the **ENTER** ►||| button again; it will change from blue to white.

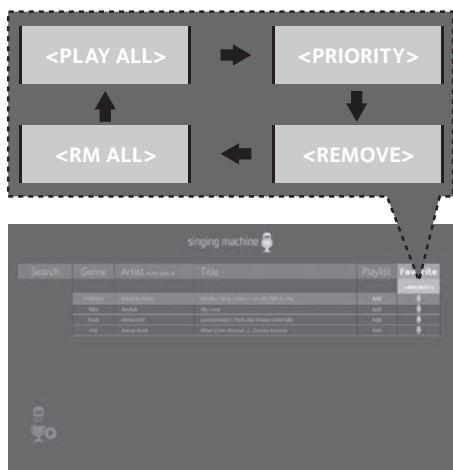

19 USING THE PLAYLIST: To play or edit your previously created Favorite playlist, you can use the **Navigation** ► Right and ◀ Left buttons to select the **Favorite** tag. Then press the **ENTER** ►||| button to show the favorites list. Perform the same steps as shown in the USING THE PLAYLIST section on the previous page to play and edit the Favorite playlist.

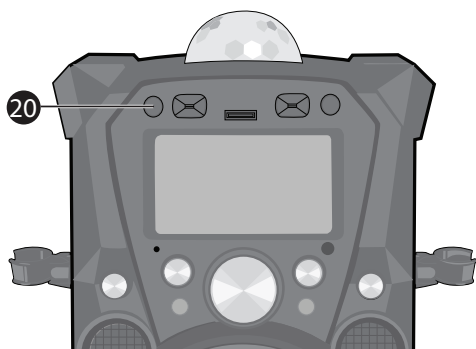

20 Press the **ON/OFF** button to turn the unit off.

Note:

When in the Menu screen, press the MENU button to go back and change categories; i.e. while in the Playlist column press the MENU button to go back and then select the Artist column, etc.

Operation

Using a Bluetooth Device



- 1 Connect the unit as described previously. Press the **ON/OFF** button to turn the unit on.
- 2 Press the **Navigation** **▶** Right or **◀** Left button to select the Bluetooth mode, then press the **ENTER** **▶||** button. You can also repeatedly press the **FUNCTION** button to select the Bluetooth mode. The Bluetooth indicator will blink as the unit automatically searches for and pairs a previously paired Bluetooth device (if previously paired). If no previously paired devices are present, “Please connect your Music Device” will appear in the monitor.

Note: You can also press the **VOCAL/PAIR** button to disconnect any paired devices in order to pair another device.

- 3 Turn on your device’s Bluetooth option in settings to search for a discoverable device with a Bluetooth signal. Select “**Singing Machine**” from the device results on the Bluetooth menu.

Note: Also refer to the user manual of your Bluetooth device for detailed instructions.

- 4 The Bluetooth indicator will light solid, a tone will sound and the monitor will display “Your Music Device is connected”.

Notes:

- If your Bluetooth device prompts you for a passcode during the pairing process, please enter “0000” to connect.
- On some Bluetooth devices, once pairing is complete, select your Bluetooth device as “Use as Audio Device” or similar.
- If connection is lost after successful pairing, check to make sure the distance between speaker and Bluetooth-enabled device does not exceed 30 ft/10 meters.

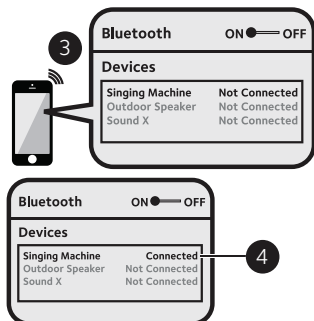
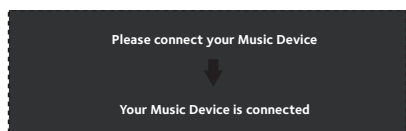

Operation

Using a Bluetooth Device (Continued)

Note: You can view the lyrics on your mobile device/tablet and get more songs by downloading the “The Singing Machine Mobile Karaoke App”; see the Welcome Kit for full instructions and to get your ten free downloads.

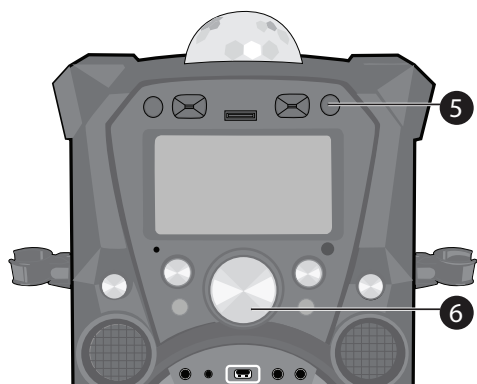

5 You can control your Bluetooth device to start the music playback OR press the **ENTER ▶||** button to start playback. Press the **ENTER ▶||** button during playback to pause the song.

6 Adjust the volume to a comfortable level using the **MASTER VOLUME** control on this unit as well as the Volume on your Bluetooth device.

Note: If connected to a TV, you can adjust the TV’s volume as well.

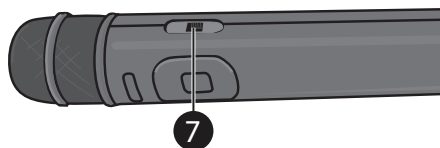

7 Connect the microphone(s) as shown on page 6. Slide the Mic’s **ON/OFF** switch to the ON position.

8 Adjust the **MIC VOLUME 1** or **2** control as desired. Increasing this will increase the volume of the the respective microphone.

9 Rotate the **ECHO** control to add an echo effect to your voice. Rotate towards MAX to increase the echo effect.

10 **SKIP:** Advance or go back one track by pressing the **Navigation ▶** Right or **◀** Left button.

Note: Pairing remains intact when the unit and/or your Bluetooth device is taken out of communication range. An active connection will be re-established when your Bluetooth device returns within range. When the unit is turned on again, it will automatically try to reconnect with the most recently paired Bluetooth device.



Operation

Using a Bluetooth Device (Continued)

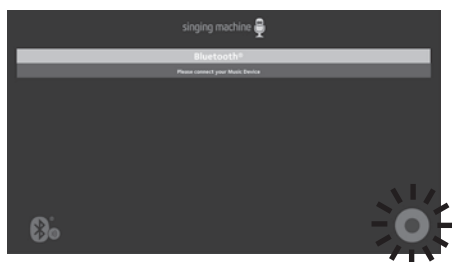

11 RECORD YOUR VOCAL PERFORMANCE:

To record your singing as well as the music, press the **RECORD** button. Recording will begin and the record icon at the bottom right corner of the monitor will blink red and blue.

When done recording, press the **RECORD** button again; the Record icon will stop blinking.

Notes:

- If an SD card is inserted, the recorded audio file will record onto it. If no SD card is present, then the recorded audio file will record onto the USB drive.
- The recorded audio file will be named with the "BT" prefix.
- See page 24 to play back your recorded files.

12 Press the **ON/OFF** button to turn the unit off.

Operation

Playing Songs from the Recorded Files

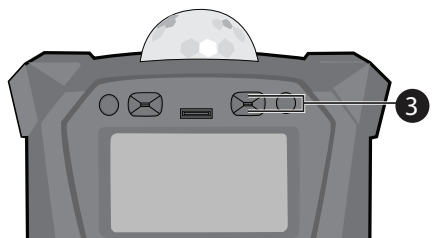
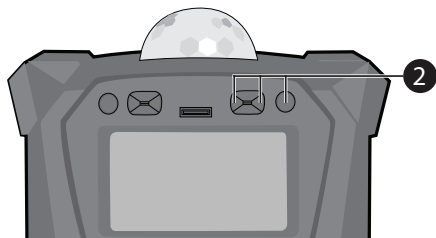

1 Connect the unit as described previously. Press the **ON/OFF** button to turn the unit on.

2 Press the **Navigation** ▶ Right or ◀ Left button to select the Recordings mode and press the **ENTER ▶|||** button to continue. You can also repeatedly press the **FUNCTION** button to select the Recordings mode.

Notes:

- The Recording mode cannot be entered unless a USB flash drive or SD card is inserted.



- A loading icon will appear when the system is loading the files.

3 Use the **Navigation** ▲ Up and ▼ Down buttons to navigate through the list of recorded files that you have previously recorded on your USB or SD Card.

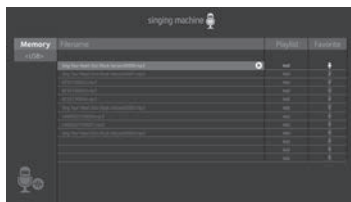

4 Press the **ENTER ▶|||** button to start the recorded audio file playback. Press the **ENTER ▶|||** button during playback to pause the file.

5 Adjust the volume to a comfortable level using the **MASTER VOLUME** control.

Operation

Playing Songs from the Recorded Files (Continued)

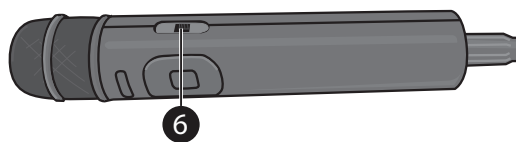

6 You can sing along with your previously recorded song. Simply connect the microphone(s) as shown on page 6. Slide the Mic's **ON/OFF** switch to the ON position.

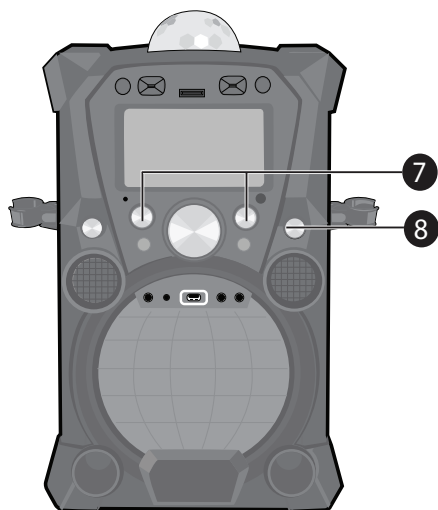

7 Adjust the **MIC VOLUME** control as desired. Increasing this will increase the volume of connected microphone(s).

8 Rotate the **ECHO** control to add an echo effect to your voice. Rotate towards **MAX** to increase the echo effect.

9 To switch between USB or SD (if both are inserted), select **Memory** using the **Navigation** ▶ Right and ◀ Left buttons, then press the **ENTER** ▶|| button. Press the **Navigation** ▶ Right or ◀ Left button to cycle from USB to SD, then press the **ENTER** ▶|| button to confirm. The playlist order will also update.



Notes:

- You can search for a title using the same procedure as shown on page 17.
- You can set and play a Playlist or Favorite using the same procedure as shown on pages 18 to 20.

Operation

Using the LINE IN Jack

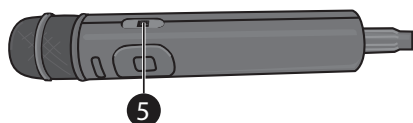
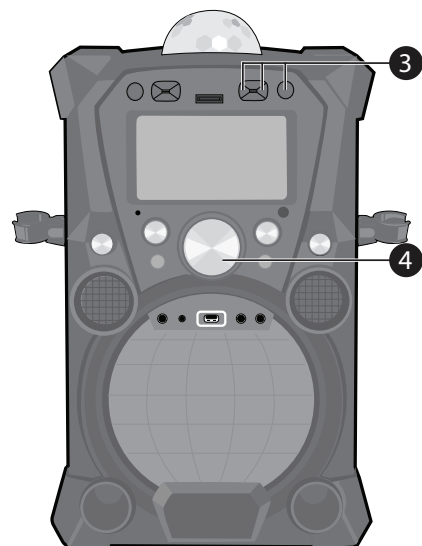
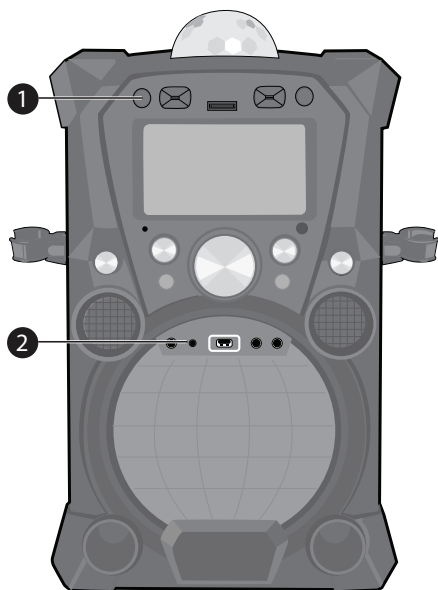

1 Connect an external unit to the LINE IN jack. Press the **ON/OFF** button to turn the unit on.

2 Connect the external unit to the LINE IN Jack on the front of this unit. Connecting an external unit will allow the audio to be played through your Singing Machine.

Notes:

- It is highly recommended to set the volume on the auxiliary unit to 1/3 or lower to avoid distortion.
- Skipping files/tracks is not possible when using an external device.

3 Press the **Navigation** ▶ Right or ◀ Left button to select the Line In mode and press the **ENTER** ▶||| button to continue. You can also repeatedly press the **FUNCTION** button to select the Line In mode. If no external unit is connected, "Please connect your Music Device" will appear in the monitor.

4 Adjust the volume using the Master Volume, TV or external device.

5 Connect the microphone(s) as shown on page 6. Slide the Mic's **ON/OFF** switch to the ON position.

Operation

Using the LINE IN Jack (Continued)



6 Adjust the **MIC VOLUME 1** or **2** control as desired. Increasing this will increase the volume of the respective microphone.

7 Rotate the **ECHO** control to add an echo effect to your voice. Rotate towards **MAX** to increase the echo effect.

8 **RECORDING YOUR SINGING:**
To record your singing as well as the music, press the **RECORD** button; recording will begin and the record icon at the bottom right of the monitor will blink red and blue.
When done recording, press the **RECORD** button again; the Record icon will stop blinking.

Notes:

- If an SD card is inserted, the recorded audio file will record on it. If no SD card is present, then the recorded audio file will record onto the USB drive.
- The recorded audio file will be named with the "LINEIN" prefix.
- See page 24 to play back your recorded files.

9 Press the **ON/OFF** button to turn the unit off.



Operation

Using the EXTERNAL INPUT Jack

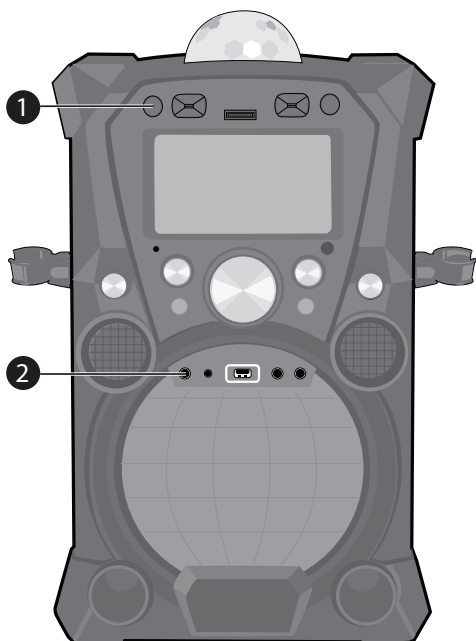

- 1 Connect the unit as described previously. Press the **ON/OFF** button to turn the unit on.
- 2 Connect the external unit to the EXTERNAL INPUT Jack on the front of this unit. Connecting an external unit will allow the audio and video to be played through your Singing Machine.

Notes:

- It is highly recommended to set the volume on the auxiliary unit to 1/3 and the EXTERNAL INPUT Volume control on this unit to 1/3 as well to avoid distortion.
 - Skipping files/tracks is not possible when using an external device.
- 3 Play the device connected to the EXTERNAL INPUT jack and it will play through this unit regardless of the function selected.

Turning the TFT Monitor Off



- 1 To turn the built-in TFT monitor Off; press and hold the **FUNCTION** button until the built in TFT monitor turns off. Repeat the same step to turn the built-in TFT monitor ON.

Troubleshooting Guide

Should this unit exhibit a problem, check the following before seeking service:

No Power

- Power is not on; press the **ON/OFF** button to turn power on.
- Make sure the unit is connected to AC power.
- Confirm the AC adapter is connected securely to the back of the unit
- Connect the unit to a different outlet.
- The unit has no battery left. Connect to AC power to recharge the battery.

No Sound – General

- Master Volume is set to minimum; raise volume.
- Correct Function was not selected; select using the **Navigation** buttons.

No Sound – If connected to a TV

- Volume on the TV is muted or too low.
- Correct source (HDMI) was not selected on the TV's menu.

Lyrics do not appear on the TV screen

- If connected to a TV, HDMI plug is not connected properly; see page 6.
- If connected to a TV, select the correct source on the TV (usually HDMI).
- The file/track being played is not a track recording with lyrics. These are the only files that allow you to view the lyrics on the TV screen.

No sound from the microphone

- Make sure it is firmly connected to the MIC 1 or MIC 2 jack.
- Make sure the **Power** switch on the Mic is set to the On position.
- Make sure the **MIC VOLUME** controls are not on the lowest setting.
- **MASTER VOLUME** is set to minimum; raise volume.
- Low/no battery. Replace the battery in the microphone.

File(s) on USB jack not playing

- The file is corrupted; replace file.
- The file is not in a format this unit will play.
- The connected USB device is not supported by the product.

The Bluetooth device cannot be paired or connected with the unit.

- You have not activated the Bluetooth function of your device; see page 21 or refer to the Bluetooth device user's manual.
- The system is not in pairing mode; press the **VOCAL/PAIR** button to restart pairing.

The Music is not available on the unit after successfully connecting the Bluetooth.

- Ensure your Bluetooth device can support the A2DP Bluetooth profile.

Updating the Firmware

Make sure the **Singing Machine USB Flash Drive** is securely plugged into the USB slot before running the update. DO NOT interrupt the update. If interrupted during the update process, the software can become corrupted and the unit will no longer function properly.

1. Create a folder on the **Singing Machine USB Flash Drive** named “user_updata”.
2. Download the latest software (e.g xxxxxx.img) from **www.singingmachine.com/softwareupdates** and save it into this folder.
3. Plug the **Singing Machine USB Flash Drive** into the USB jack on the unit and turn the unit on.
4. The unit will update automatically.

Specifications

AUDIO

Output Power (Tweeters) 5 Watts (RMS) 8 Ohms (2)

Output Power (Full range) 20 Watts (RMS) 4 Ohms

BLUETOOTH

Bluetooth Version V2.1 + EDR

Working Distance Up to 30 feet/10 meters measured in open space

RECORDED FILE

MP3 Encoding 128kbps

USB AND SD

Format FAT32

Maximum Capacity 32GB

JACK

Microphone 6.3 mm Microphone Jacks (2)

External Input 6.3 mm Microphone Jack

GENERAL

Power AC 100-240V, 50-60 Hz

Battery (Lead Acid) 12V 6.8Ah

Dimensions - Main Unit 22.05 (H) x 13.3 (W) x 14.2 (D) in (560 x 340 x 339 mm)

Weight - Main Unit 19.2 lbs (8.7 kg)

Microphone -74 dB 600 Ohms impedance with 6.3 mm Dynamic Microphone

Specifications are subject to change without notice.

Visit Our Website: www.singingmachine.com

The Singing Machine Company, Inc.
4060 E Jurupa Street, Unit B
Ontario, CA 91761-1413 USA