

PENTAX™

Digital Camera

Optio W10

Operating Manual



To ensure the best performance from your camera, please read the Operating Manual before using the camera.

Thank you for buying the PENTAX Digital Camera.

Please read this manual before using the camera in order to get the most out of all the features and functions. Keep this manual safe, as it can be a valuable tool in helping you to understand all the camera's capabilities.

Regarding copyrights

Images taken using the PENTAX Digital Camera that are for anything other than personal enjoyment cannot be used without permission according to the rights as specified in the Copyright Act. Please take care, as there are even cases where limitations are placed on taking pictures even for personal enjoyment during demonstrations, performances or of items on display. Images taken with the purpose of obtaining copyrights also cannot be used outside the scope of use of the copyright as laid out in the Copyright Act, and care should be taken here also.

Regarding trademarks

- PENTAX and Optio are trademarks of PENTAX Corporation.
- The SD logo  is a trademark.
- QuickTime™ and QuickTime logo are trademarks used under license. The QuickTime logo is registered in U.S. and other countries.
- All other brands or product names are trademarks or registered trademarks of their respective owners.

To users of this camera

- There is a possibility that recorded data may be erased or that the camera may not function correctly when used in surroundings such as installations generating strong electromagnetic radiation or magnetic fields.
- The liquid crystal panel used in the LCD display is manufactured using extremely high precision technology. Although the level of functioning pixels is 99.99% or better, you should be aware that 0.01% or fewer of the pixels may not illuminate or may illuminate when they should not. However, this has no effect on the recorded image.

This product supports PRINT Image Matching III, PRINT Image Matching enabled digital still cameras, printers and software help photographers to produce images more faithful to their intentions. Some functions are not available on printers that are not PRINT Image Matching III compliant.

Copyright 2001 Seiko Epson Corporation. All Right Reserved.

PRINT Image Matching is a trademark of Seiko Epson Corporation. The PRINT Image Matching logo is a trademark of Seiko Epson Corporation.

Regarding PictBridge

PictBridge allows the user to connect the printer and digital camera directly, using the unified standard for the direct printout of images. You can print images directly from the camera through a few simple operations.

- There is a possibility that the illustrations and the display screen of the LCD monitor in this manual are different from the actual product.

Regarding Product Registration

In order to better service you, we request that you complete the product registration, which can be found on the CD-ROM supplied with the camera or the PENTAX website. Thank you for your cooperation.

Refer to the PC Connection Manual (bottom right of the front side) for more information.

FOR SAFE USE OF YOUR CAMERA

Sufficient attention has been paid to the safety of this product but please pay particular attention to the warnings indicated by the following symbols during use.



Warning

These symbols indicate that it is possible that the user may experience serious difficulties if the warnings are not heeded.



Caution

These symbols indicate that it is possible that the user may experience minor or middling difficulties or physical difficulties if the warnings are not heeded.

About the Camera



Warning

- Do not attempt to take the camera apart or remodel the camera. High voltages are present within the camera, and there is therefore a danger of electric shocks if the camera is taken apart.
- If the inside of the camera should become exposed as a result of, for example, the camera being dropped, please do not under any circumstances touch such exposed portions, as there is a danger of receiving an electric shock.
- To avoid the risk of it being swallowed by mistake, keep the SD Memory Card out of the reach of small children. Seek medical attention immediately if a card is accidentally swallowed.
- Wrapping the strap of the camera around your neck is also dangerous. Please take care that small children do not hang the strap around their necks.
- Use an AC adapter that is of the power and voltage specified for exclusive use with this product. The use of an AC adapter other than that specified exclusively for use with this product may cause fire or electric shocks.
- If the camera emits smoke or a strange smell, or in the event of any other irregularity, stop using the camera immediately, remove the battery and contact your nearest PENTAX Service Center. Continued use of the camera may result in fire or electric shock.

Caution

- Never try to disassemble or short the battery. Also, do not dispose of the battery in a fire, as it may explode.
- Do not charge any batteries other than rechargeable lithium-ion battery D-LI8. The battery could explode or catch fire.
- Do not place your finger on the flash when it is discharging as there is a risk of burns.
- Do not discharge the flash while it is touching your clothing as there is a risk of discoloring.
- If any of the battery leakage should come in contact with your eyes, do not rub them. Flush your eyes with clean water and get medical attention immediately.
- If any of the battery leakage should come in contact with skin or clothes, wash the affected areas thoroughly with water.
- Remove the battery from the camera immediately if it becomes hot or begins to smoke. Be careful not to burn yourself during removal.
- Some portions of the camera heat up during use, so please take care, as there is a risk of low temperature burns if such portions are held for long periods of time.
- Should the LCD be damaged, be careful of glass fragments. Also, be careful not to allow the liquid crystal to get on your skin or in your eyes or in your mouth.

About the Battery Charger and the AC Adapter

Warning

- Do not use the product at a voltage other than the specified voltage. Use with a power source or voltage other than that designed can cause a fire or electrical shock. The specified voltage is 100-240V AC.
- Do not disassemble or modify the product. This can cause a fire or electrical shock.
- If the generation of smoke or strange odor from the product or other abnormality occurs, immediately discontinue using and consult a PENTAX Service Center. Continuing to use the product can cause a fire or electrical shock.
- If water should happen to get inside the product, consult a PENTAX Service Center. Continuing to use the product can cause a fire or electrical shock.

- If lightning should be present during use of the battery charger or AC adapter, unplug the power cord and discontinue use. Continuing to use the product can cause damage to the equipment, fire or electrical shock.
- Wipe off the plug of the power cord if it should become covered with dust. This can cause a fire.

Caution

- Do not place heavy objects on the AC plug cord, allow heavy objects to drop onto it or allow the AC plug cord to become damaged due to excessive bending. If the AC plug cord becomes damaged, consult a PENTAX Service Center.
- Do not short or touch the output terminals of the product while it is still plugged in.
- Do not plug in the AC plug cord with wet hands. This can cause an electrical shock.
- Do not subject the product to strong impacts or allow it to drop onto a hard surface. This can cause a malfunction.
- Do not use the battery charger to charge batteries other than rechargeable lithium-ion battery D-Li8. This can cause overheating or malfunctions.

Care to be Taken During Handling



- Take the Worldwide Service Network listing that is included in the package with you when traveling. This will be useful if you experience problems abroad.
- When the camera has not been used for a long time, confirm that it is still working properly, particularly prior to taking important pictures (such as at a wedding or during traveling). Contents of the recording cannot be guaranteed if recording, playback or transferring your data to a computer, etc. is not possible due to a malfunction of your camera or recording media (SD Memory Card), etc.
- The lens on this camera is not interchangeable. The lens is not removable.
- Do not clean the product with organic solvents such as thinner, alcohol or benzene.
- Places of high temperature and humidity should be avoided. Particular care should be taken regarding vehicles, which can become very hot inside.
- Storing the camera where pesticides and chemicals are handled should be avoided. Remove from case and store in a well-ventilated place to prevent the camera from becoming moldy during storage.

- Ensure that the camera is not subjected to substantial vibrations, shocks or pressure as this may cause damage, malfunction, or a loss in waterproof performance. Place the camera on a cushion for protection when the camera is subjected to the vibrations of a motorbike, car, ship, etc. If the camera is subjected to substantial vibrations, shocks or pressure, take your camera to your nearest PENTAX Service Center and have it checked.
- The temperature range in which the camera can be used is 0°C to 40°C (32°F to 104°F).
- The liquid crystal display will become black at a high temperature but will return to normal when normal temperatures are returned to.
- The response speed of the liquid crystal display becomes slow at low temperatures. This is due to the properties of the liquid crystal and is not a fault.
- Periodic checks are recommended every 1 to 2 years in order to maintain high performance.
- If the camera is subjected to rapid temperature changes, condensation may form on the inside and outside of the camera. Therefore put the camera in a bag or plastic bag, and take the camera out when the difference in temperature has subsided.
- Refer to “Precautions When Using an SD Memory Card” (p.30) regarding the SD Memory Card.
- Please note that formatting an SD memory card or built-in memory will delete all data; however it may still be possible to recover that data using off-the-shelf data recovery software. Please manage your camera’s memory at your own risk.
- Please do not press forcefully on the LCD monitor. This could cause breakage or malfunction.
- Be careful not to sit down with the camera in your back pocket as this may damage the exterior of the camera or the LCD monitor.
- When using a tripod with the camera, be careful not to overtighten the screw in the tripod socket on the camera.
- The AC plug cord supplied with the camera is for exclusive use with the battery charger D-BC8. Do not use it with any other equipment.



Waterproof and Dustproof Function

- This camera has been proven to comply with JIS Class 8 waterproof performance and Class 5 dustproof performance (IP58).
- To enhance the waterproof performance of the camera, the front of the lens is protected by glass. As any dirt or water on the glass will affect the quality of pictures taken, the glass should be kept clean at all times.
- Do not place the camera directly on the sand at the beach or similar places.
- The camera will sink if dropped in water, so be sure to attach the strap and slip the strap over your wrist when using the camera in or near water.
- Be sure to check that the battery/card cover is securely locked before using the camera in an environment where it is likely to get wet or dirty, such as underwater or at the beach. Water, sand or dirt inside the camera may cause failure of the camera. Wipe off any water or dirt with a dry cloth as soon as possible after using the camera.
- Avoid opening the battery/card cover at the beach or by the sea. Wait until the camera is completely dry before changing the battery or the SD Memory Card. Avoid changing the battery or card where the camera is likely to get wet or dirty, and make sure that your hands are dry.
- If the camera is very dirty or after it has been used in the sea, make sure that it is turned off and the battery/card cover is firmly closed before rinsing it under running tap water or leaving it in a bowl of clean water for a short time (2 or 3 minutes).
- Avoid cleaning with agents such as soap water, mild detergents, and alcohol as this may compromise the waterproof performance of the camera.
- Wipe off any dirt or sand on the waterproof packing or the packing contact surface. The camera's waterproof function may be compromised by loose packing, or cracks or dents in the packing or packing contact surface. If there is any such damage, contact your nearest PENTAX Service Center.
- To maintain the waterproof performance of the camera, you are recommended to change the waterproof packing once a year. Contact your nearest PENTAX Service Center regarding changing the packing. (A charge will be made.)
- Avoid subjecting the camera to substantial vibrations, shocks, or pressure as this may cause a loss in waterproof performance. If the camera is subjected to substantial vibrations, shocks or pressure, take your camera to your nearest PENTAX Service Center and have it checked.
- Avoid getting sunscreen or sun oil on the camera as it may cause discoloration of the surface. If any oil gets on the camera, wash it off immediately with warm water.
- The waterproof function does not apply to the camera's accessories.

Contents

FOR SAFE USE OF YOUR CAMERA	1
Care to be Taken During Handling	3
Contents	6
Composition of the Operating Manual	11
Camera Features	12
Checking the Contents of the Package	16
Names of Parts	17
Names of Operating Parts	18
Monitor Indications	18
Getting Started	21
Attaching the Strap	21
Powering the Camera	22
Charging the Battery	22
Installing the Battery	23
Charging the Battery Abroad	25
Using the AC Adapter	27
Installing the SD Memory Card	28
Recorded Pixels and Quality Level of Still Pictures	31
Recorded Pixels, Quality Level and Frame Rate of Movies	32
Turning the Camera On and Off	34
Playback Only Mode	35
Initial Settings	36
Setting the Display Language	36
Setting the Date and Time	38
Quick Start	40
Taking Still Pictures	40
Playing Back Still Pictures	42
Playing Back Images	42
Playing Back the Previous or Next Image	42
Rotating the Displayed Image	43
Common Operations	44
Understanding the Button Functions	44
 Mode	44
 Mode	46

Setting the Camera Functions	48
Setting with the Menu	48
Menu List	51
Setting the Shooting Mode	53
Calling Up a Specific Menu	58
Setting the Playback Mode	60
Taking Pictures	63
<hr/>	
Taking Pictures	63
Letting the Camera Choose the Optimal Settings (Program Mode) ...	63
Taking Pictures in the Basic Mode (Green Mode)	64
Taking Pictures of Dark Scenes	
(Night Scene/Candlelight/Fireworks Mode)	66
Framing Your Pictures (Frame Composite)	67
Taking Pictures of People (Portrait/Self-portrait/Natural Skin Tone) ...	68
Taking Pictures of Your Pet (Pet Mode)	70
Taking Underwater Pictures	
(Underwater Mode/Underwater Movie Mode)	72
Taking Still Pictures with Sound (Synchro Sound Record)	74
Taking Pictures of Text (Text Mode)	75
Using the Self-timer	76
Taking a Series of Pictures (Continuous Shooting Mode/High	
Speed Continuous Shooting Mode)	77
Taking Pictures at a Set Interval (Interval Shoot)	78
Using the Zoom	80
Setting the Exposure (EV Compensation)	82
Displaying Shooting Information in Capture Mode	83
Setting the Shooting Functions	85
Selecting the Focus Mode	85
Selecting the Flash Mode	87
Selecting the Recorded Pixels	89
Selecting the Quality Level	91
Adjusting the White Balance	92
Setting the AE Metering	94
Setting the Sensitivity	96
Setting the Autofocus Conditions	97
Setting the Instant Review Time (Instant Review)	99
Setting the Image Sharpness (Sharpness)	100
Setting the Color Saturation (Saturation)	101
Setting the Image Contrast (Contrast)	102
Saving the Settings (Memory)	103

Recording Movies	105
Recording a Movie	105
Selecting the Recorded Pixels for Movies	107
Selecting the Quality Level of Movies	108
Selecting the Frame Rate	109
Recording Movies in Black and White or Sepia Tones (Color Mode) ...	110
Setting the Movie Anti-Shake Function	111
Setting the Optical Zoom	112
Playing Back and Deleting Images	113
Playing Back Images	113
To Switch Between  Mode and  Mode	113
Playing Back Still Pictures	113
Nine-Image Display, Folder Display and Calendar Display	114
Zoom Playback	116
Displaying Shooting Information in Playback Mode	118
Slideshow	119
Playing Back Movies	121
Playing Back a Movie	121
Connecting the Camera to AV Equipment	122
Deleting Images	123
Deleting Single Images/Sound Files	123
Deleting Selected Images and Sound Files (from Nine-Image Display)	125
Deleting All Images	127
Recovering Deleted Images	128
Protecting Images and Sound Files from Deletion (Protect)	129
Editing and Printing Images	131
Editing Images	131
Changing the Image Size and Quality (Resize)	131
Trimming Images	133
Copying Images and Sound Files	134
Using the Digital Filters	136
Using the Brightness Filter	137
Red-eye Compensation	138
Adding a Frame (Frame Composite)	139
Editing Movies	141
Setting the Printing Service (DPOF)	145
Printing Single Images	145
Printing All Images	147

Printing Using PictBridge	148
Connecting the Camera to the Printer	148
Printing Single Images.....	149
Printing All Images.....	151
Printing Using the DPOF Settings	152
Disconnecting the Cable from the Printer	152
Recording and Playing Back Sound	153
Recording Sound (Voice Recording Mode).....	153
Playing Back Sound	155
Adding a Voice Memo to Images	156
Recording a Voice Memo	156
Playing Back a Voice Memo	157
Settings	158
Camera Settings.....	158
Formatting an SD Memory Card or the Built-in Memory	158
Changing the Date and Time.....	159
Changing the Sound Settings.....	161
Setting the Alarm	163
Setting the World Time	165
Changing the Display Language	167
Changing the Image Folder Name	168
Changing the USB Connection Mode.....	169
Changing the Video Output Format.....	170
Adjusting the Brightness of the LCD Monitor.....	171
Using the Power Saving Function	172
Setting Auto Power Off	173
Changing the Start-up Screen	174
Changing the Menu Order	175
Resetting to Default Settings (Reset)	176
Displaying the Clock Mode	178
Appendix	179
List of World Time Cities	179
Default Settings.....	180
Functions Available for Each Shooting Mode.....	183
Optional Accessories	185
Messages.....	186
Troubleshooting.....	188
Main Specifications	190
WARRANTY POLICY.....	194
Index.....	199

In this manual, the method for operating the four-way controller is shown in illustrations, such as in the one below.

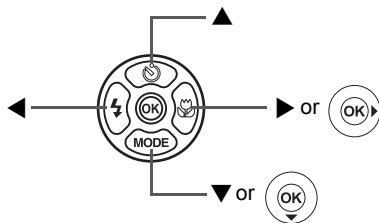

The meanings of the symbols used in this operating manual are explained below.

	indicates the reference page number for an explanation of the related operation.
	indicates information that is useful to know.
	indicates precautions to be taken when operating the camera.
mode	This is the mode for capturing still pictures and recording movies and sound files. In this manual, the mode for taking still pictures is referred to as the "Still Picture Capture Mode", the mode for recording movies is referred to as the " mode" and the mode for recording sound files is referred to as the " mode".
mode	This is the mode for viewing still pictures and playing back movies and sound files.
 SOFT	<p>The icons above the title show the shooting modes that can activate the function.</p> <p>Ex. </p> <p>Setting the Image Sharpness (Sharpness)</p>

Composition of the Operating Manual

This operating manual contains the following chapters.

1 Getting Started

This chapter explains what you need to do after purchasing the camera before you start taking pictures. Be sure to read it and follow the instructions.

2 Quick Start

This chapter explains the simplest way to take pictures and play back images. Use it if you want to start taking pictures or playing back images straightaway.

3 Common Operations

This chapter explains common operations such as the functions of the buttons and how to use the menus. For more details, refer to the respective chapters below.

4 Taking Pictures

This chapter explains the various ways of capturing images and how to set the relevant functions.

5 Playing Back and Deleting Images

This chapter explains how to view still pictures and movies on the camera or on a TV and how to delete images from the camera.

6 Editing and Printing Images

This chapter explains the various ways of printing still pictures and how to edit images with the camera. For information on transferring images to a PC and installing ACDSee for PENTAX, see the supplied "PC Connection Manual". For details on editing and printing images on a PC, see the Help section in the ACDSee for PENTAX software.

7 Recording and Playing Back Sound

This chapter explains how to record sound files or add sound (a voice memo) to an image, and how to play back sound files.

8 Settings

This chapter explains how to set the camera-related functions.

9 Appendix

This section deals with troubleshooting and lists the optional accessories.

1

2

3

4

5

6

7

8

9

Camera Features

In addition to basic picture-taking, the Optio W10 has a variety of shooting modes to suit different situations. This section describes how to make the most of the key features of your camera. Together with the explanations of camera operations, it will enable you to enjoy your camera to the full.

Forget Your Worries About Water Getting in the Camera!

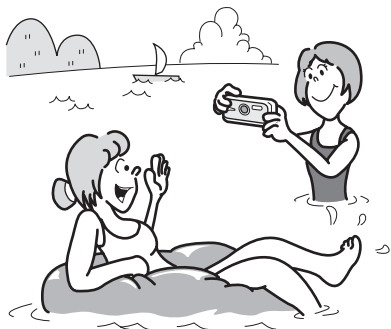

The Optio W10 has high waterproof performance that lets you take pictures continuously for 30 minutes 1.5 m (5 ft.) underwater. The lock mechanism of the battery/card cover is designed for underwater picture-taking. (p.72)

- For taking pictures while snorkeling.
- For taking pictures at the pool or while playing in a river or lake.
- For taking pictures while enjoying various outdoor activities without worrying about your camera getting a bit dirty. A quick wipe with a wet cloth is all it needs!

Advanced Movie Recording and Picture Taking Functions

The Optio W10 has an anti-shake function to prevent camera shake during movie recording. (p.111) You can also take pictures while recording a movie. (p.106)

- For recording the action of sporting events as a movie while capturing the winning shot in a picture.

Record Sound Before and After Taking Pictures!

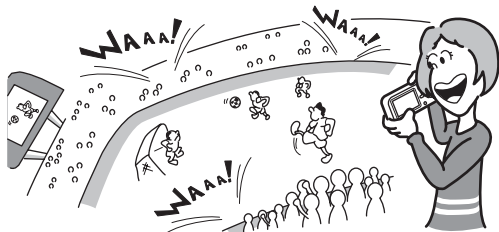

With the Optio W10, not only can you add a voice memo to a still picture, but by switching to Synchrony Sound Record mode, the surrounding sounds are automatically captured until you press the shutter release button to take the picture. A total of 20 seconds of sound, 10 seconds before and 10 seconds after the shutter release button is pressed, are saved. (p.74)

- For recording yourself saying “Say cheese!” or “Look at the camera”
- For including the cheers of the crowd at exciting moments of a sporting event.

Add Fun Frames to Your Pictures!

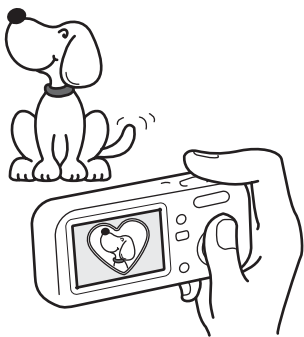

With the Optio W10, you can add a fun frame when taking a picture of a child or your pet, for example. (p.67) You can also add frames to pictures you have taken. Adjust the position of the subject in the picture or reduce or enlarge the picture size to match the frame shape and size. Now you no longer have to worry about the subject not being aligned in the frame. (p.139)

- For decorating your pictures with a frame.

Easy-to-Navigate Capture and Playback Functions!

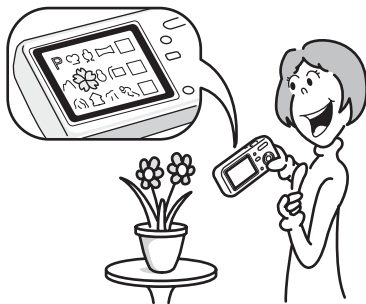

The user-friendly design of the Optio W10 enables easy operation with only a few buttons. Simply by choosing the appropriate icon, you can select Shooting mode (p.53) and choose the optimal settings for the situation, or Playback mode (p.113, p.131) and enjoy the various playback and editing functions. A guide on the LCD monitor lets you check the functions available in each mode and how to use them. (p.62)

- **Press the Green button while the Capture Mode Palette or Playback Mode Palette is displayed to display the guide. (p.62)**
- **Use the Green Mode to take pictures easily using standard settings. (p.64)**

Display Images and Sound Files in Calendar Format!

With the Optio W10, you can display recorded images and sound files by date in calendar format. (p.115) This lets you quickly find the image or sound file you want to play back.

Perfect Size for Carrying Around With You!



With its compact, stylish design, the Optio W10 is just right to slip into a pocket of your bag or hang round your neck, so you always have it with you, like your cell phone. It has a useful clock function, “Clock Mode” for telling the time too. (p.178)

Enjoy Playback and Editing Functions Without a Computer!

The Optio W10 lets you play back and edit images without having to connect the camera to your computer and transfer the images first. The camera is all you need to take and edit still pictures and movies. (p.131) And no more worries about accidentally deleting images, because now, with the Optio W10, you can recover them again. (p.128)



- **The wide range of editing functions includes resizing (p.131), trimming (p.133), changing the color (p.136) and adjusting the brightness. (p.137)**
- **If your subject's eyes appear red in the picture, you can correct them while the image is displayed in Playback mode. (p.138)**
- **You can divide a movie into two, stitch two movies together or select a frame from a movie to save as a still picture. (p.141)**

Checking the Contents of the Package



Camera
Optio W10

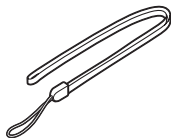

Strap
O-ST20 (*)

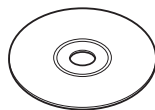

Software (CD-ROM)
S-SW48

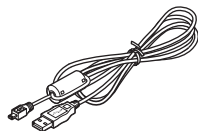

USB cable
I-USB7 (*)

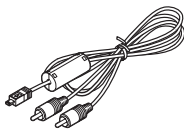

AV cable
I-AVC7 (*)



Rechargeable lithium-ion
battery D-LI8 (*)

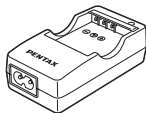

Battery charger
D-BC8 (*)



AC plug cord
D-CO2 (*)

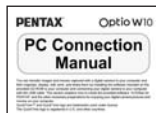

PC Connection Manual



Operating Manual
(this manual)

Quick Guide

Items marked with an asterisk (*) are also available as optional accessories. For other optional accessories, refer to "Optional Accessories" (p.185).

Names of Parts

Front

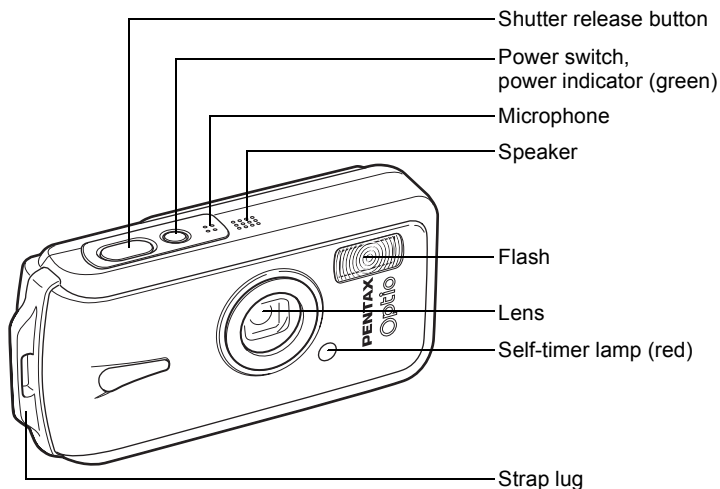

Back

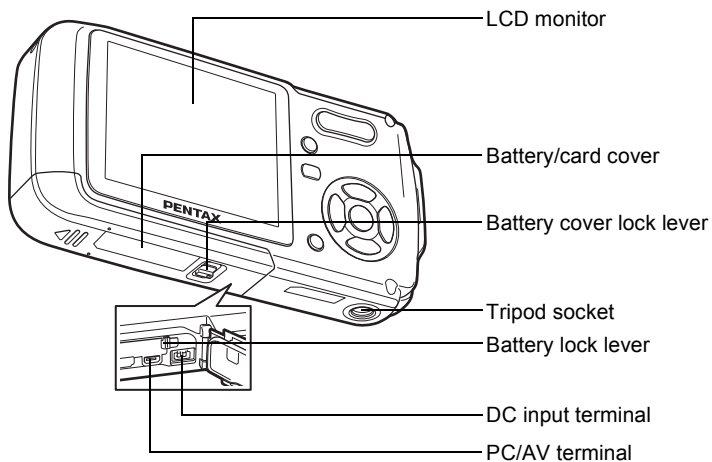

Names of Operating Parts

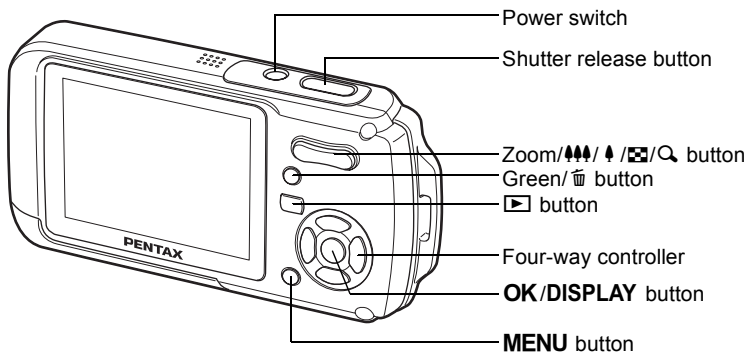





Refer to “Understanding the Button Functions” (p.44 - p.47) for an explanation of the function of each button.

Monitor Indications

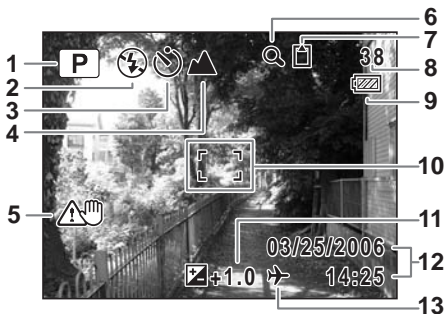
Normal Display in Still Picture Capture Mode

The display shows information such as the shooting conditions.



- | | |
|---------------------------------|------------------------------------|
| 1 Shooting mode (p.53) | 8 Remaining image storage capacity |
| 2 Flash mode (p.87) | 9 Battery indicator (p.24) |
| 3 Drive mode (p.76, p.77, p.78) | 10 Focus frame (p.40) |
| 4 Focus mode (p.85) | 11 EV compensation (p.82) |
| 5 Camera shake icon (p.83) | 12 Date and time (p.38) |
| 6 Digital zoom icon (p.80) | 13 World time setting (p.165) |
| 7 Memory status (p.34) | |
-  : Built-in memory
 (without card)
 : SD Memory Card
 : Card is write-protected

Histogram + Info Display in Still Picture Capture Mode



- | | |
|--------------------------------|------------------------|
| 1 Bright portion (blinks red) | 6 Quality (p.91) |
| 2 Dark portion (blinks yellow) | 7 White balance (p.92) |
| 3 Shutter speed | 8 AE Metering (p.94) |
| 4 Aperture | 9 Sensitivity (p.96) |
| 5 Recorded pixels (p.89) | 10 Histogram (p.84) |

About the Bright and Dark Portions

When there is an area in the frame that is so bright it appears white, the indicated area blinks red as a warning. Similarly, when there is an area that is so dark it appears black, the indicated area blinks yellow as a warning.

Full Display in Still Picture Playback Mode

(All of the display items are displayed here for explanatory purposes.)

The display shows information such as the shooting conditions. A1 to A11 appear when [Normal Display] or [Histogram + Info] is selected. B1 to B10 only appear when [Histogram + Info] is selected. (p.118)

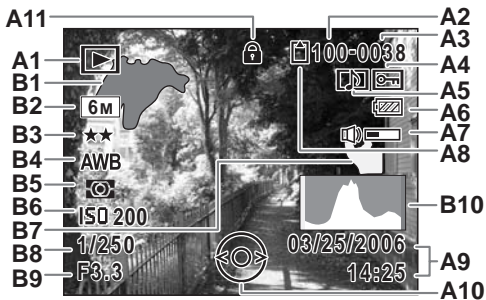

- | | |
|---|---|
| A1 Playback mode (p.60) | A10 Four-way controller guide |
| A2 Folder number (p.168) | A11 Key lock icon (p.64) |
| A3 File number | B1 Bright portion (blinks red) (p.19) |
| A4 Protect icon (p.129) | B2 Recorded pixels (p.89) |
| A5 Voice memo icon (p.157) | B3 Quality (p.91) |
| A6 Battery indicator (p.24) | B4 White balance (p.92) |
| A7 Volume icon (p.157) | B5 AE Metering (p.94) |
| A8 Memory status (p.34) | B6 Sensitivity (p.96) |
| : Built-in memory (without card) | B7 Dark portion (blinks yellow) (p.19) |
| : SD Memory Card | B8 Shutter speed |
| : Card is write-protected | B9 Aperture |
| A9 Captured date and time (p.38) | B10 Histogram (p.84) |

In Normal Display, A6 and A9 disappear if no operation is performed in two seconds.

Guide Indications

A guide to available button operations appears on the LCD monitor during operation.

The buttons are indicated as shown below.

Four-way controller (▲)	▲
Four-way controller (▼)	▼
Four-way controller (◀)	◀
Four-way controller (▶)	▶
MENU button	

Zoom button	
OK/DISPLAY button	
Shutter release button	
Green/ button	

Attaching the Strap

Attach the strap (O-ST20) supplied with the camera.

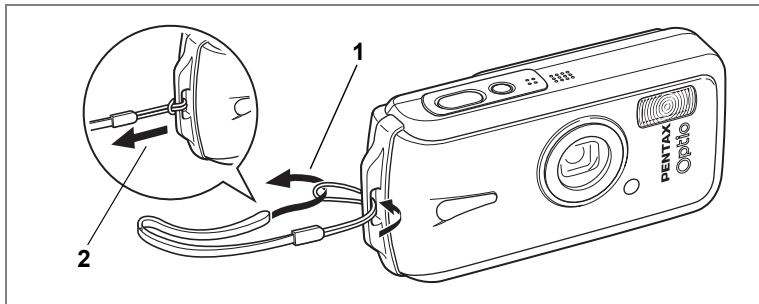

- 1** Pass the narrow end of the strap through the strap lug.
- 2** Pass the other end of the strap through the loop and pull tight.

Powering the Camera

1

Getting Started

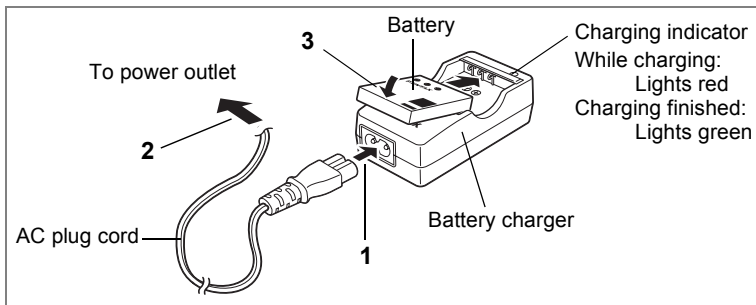

Charging the Battery

Use the battery charger to charge the battery before using it in the camera for the first time or after a long period of non-use, or when the [Battery depleted] message appears.

- 1 Connect the AC plug cord to the battery charger D-BC8.**
- 2 Plug the AC plug cord into the power outlet.**
- 3 Place the battery in the charger so that the PENTAX logo is visible.**

The charging indicator lights red while the battery is charging and changes to green when charging is finished.
- 4 Remove the battery from the battery charger when charging is finished.**



- The time required to fully charge the battery is about 100 minutes (max.). The appropriate ambient temperature for charging the battery is 0°C to 40°C (32°F to 104°F). (The charging time may vary depending on the ambient temperature and charging conditions.)
- The battery has reached the end of its service life when it starts to run down soon after being charged. Replace with a new battery.



- Do not use the battery charger to charge batteries other than the rechargeable lithium-ion battery D-LI8, as the charger may overheat or be damaged.
- If the battery is inserted correctly but the charging indicator fails to light, the battery may be faulty. Replace with a new battery.

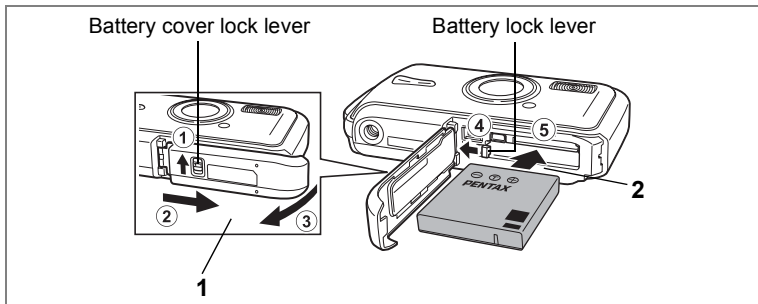

Installing the Battery

Use the battery that is provided with the camera. Charge the battery before using it in the camera for the first time.

1 Open the battery/card cover.

Press the battery cover lock lever in the direction of ①, slide the battery/card cover in the direction of ② and flip the cover open in the direction of ③.

2 Using the side of the battery to press the battery lock lever in the direction of ④, insert the battery with the side with the PENTAX logo pointing toward the lens.

Push the battery in until it is locked in place.

3 Close the battery/card cover.

Press the battery cover lock lever in the opposite direction to ①. Press it until the red area under the lever cannot be seen.

Removing the Battery

1 Open the battery/card cover.

2 Release the battery by using your finger to press the battery lock lever in the direction of ④.

The battery will be ejected. Pull the battery out of the camera.



Do not apply excessive pressure to the front or back of the camera when opening and closing the battery/card cover as this may dislodge the waterproof packing. If the packing is not in the correct position, the waterproof performance of the camera will be compromised.



- This camera uses a rechargeable lithium-ion battery D-LI8. Use of any other type of battery may damage the camera and cause malfunction.
- Insert the battery correctly. If the battery is incorrectly oriented, malfunction may result.
- Do not remove the battery while the camera is turned on.
- If you do not intend to use the camera for a long time, remove the battery.
- The date and time may be returned to the default setting if the camera is left without the battery for a long time.
- Allow the camera to dry completely before changing the battery. Avoid changing the battery where the camera is likely to get wet or dirty, and make sure that your hands are dry.

• **Image Storage Capacity, Movie Recording Time, Sound Recording Time, and Playback Time**
(at 23°C with the LCD monitor on and the battery fully charged)

Image Storage Capacity ^{*1} (the flash used for 50% of shots)	Movie Recording Time ^{*2}	Sound Recording Time ^{*2}	Playback Time ^{*2}
240 pictures	80 min.	240 min.	240 min.

*1: Recording capacity shows approximate number of shots recorded during CIPA-compliant testing. (with LCD monitor on, flash used for 50% of the shots, and 23 degrees centigrade) Actual performance may vary according to operating conditions.





*2: According to the result of in-house testing.



- In general, battery performance may temporarily deteriorate as the temperature decreases.
- Be sure to take a spare battery with you when traveling abroad or to a cold region, or if you intend to take a lot of pictures.

• **Battery Level Indicator**

You can check the battery level by the  indicator on the LCD monitor.

Screen Display	Battery Status
 (green)	Adequate power remains.
 (green)	Battery is running low.
 (yellow)	Battery is running very low.
 (red)	Battery is exhausted.
[Battery depleted]	The camera will turn off after this message appears.

● Recycling Batteries



This symbol indicates that the battery is recyclable. Cover the terminals with insulating tape and take the battery to a store displaying this symbol.

Li-ion

Charging the Battery Abroad

The battery charger supplied with the camera is designed to switch automatically to the voltage (100-240V) and frequency (50Hz, 60Hz) of the electricity supply in the country or region where used.

However, electrical socket shapes differ from country to country. Before traveling abroad, you are advised to check the socket shape in the country of your destination (see “Main Socket Types in the Major Countries and Regions of the World” (p.26)) and take an appropriately shaped adapter plug with you.

The socket shape does not affect the charging method.

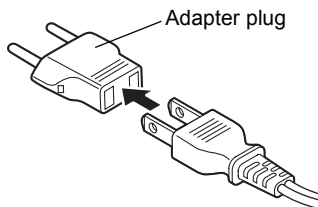

- Use of an off-the-shelf transformer may lead to defective operation.
- Unplug the adapter plug from the power outlet when the battery charger is not in use.

Type	A	B	BF	C	S
Shape					
Adapter plug	-				

Main Socket Types in the Major Countries and Regions of the World

1

Getting Started

		A	B	BF	C	S
North America	U.S.A., Canada	✓				
Europe, Former Soviet Union	Iceland, Ireland, Italy, Ukraine, Austria, Netherlands, Kazakhstan, Greece, Sweden, Denmark, Germany, Norway, Hungary, Finland, France, Belarus, Belgium, Rumania, Russia				✓	
	U.K.		✓	✓		
	Spain	✓			✓	
	Switzerland, Poland, Portugal		✓		✓	
Asia	Taiwan, Japan	✓				
	Sri Lanka, Maldives		✓			
	Nepal, Bangladesh, Mongolia				✓	
	Vietnam	✓			✓	
	India, Indonesia, Pakistan, Macau		✓		✓	
	Thailand	✓		✓	✓	
	Korea	✓	✓		✓	
	Philippines	✓			✓	✓
	Singapore, Hong Kong		✓	✓		
	China	✓	✓	✓	✓	✓
	Malaysia		✓	✓	✓	
Oceania	Australia, Tonga, New Zealand, Fiji					✓
	Guam	✓				
	Tahiti				✓	
Central and South America	Colombia, Jamaica, Haiti, Panama, Bahamas, Puerto Rico, Venezuela, Mexico	✓				
	Brazil, Peru	✓			✓	
	Chile		✓		✓	
	Argentina			✓	✓	✓
Middle East	Israel, Iran				✓	
	Kuwait		✓		✓	
	Jordan		✓	✓		
Africa	Canary Islands, Guinea, Mozambique, Morocco				✓	
	Kenya, South Africa		✓		✓	
	Algeria	✓	✓	✓		
	Egypt		✓	✓	✓	
	Zambia, Tanzania		✓	✓		

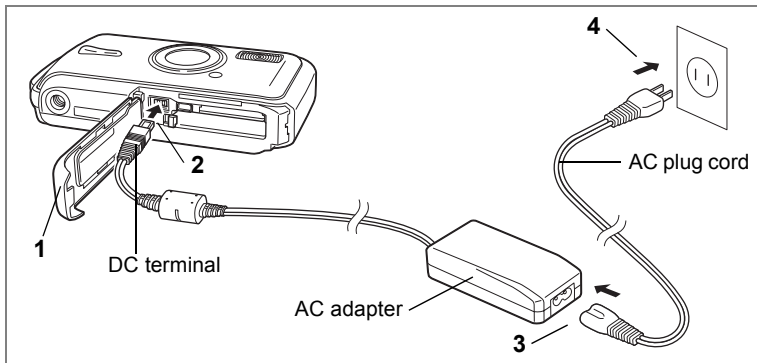

Using the AC Adapter

Use of the AC adapter kit K-AC8 (optional) is recommended if you intend to use the camera for a long time or connect it to a PC.

- 1** Make sure that the camera is turned off and open the battery/card cover.
- 2** Connect the DC terminal of the AC adapter to the DC input terminal of the camera with the ▲ symbol pointed toward the LCD monitor.
- 3** Connect the AC plug cord to the AC adapter.
- 4** Plug the AC plug cord into the power outlet.

Caution

- Make sure that the camera is turned off before connecting or disconnecting the AC adapter.
- Make sure that the AC plug cord and the power cord connecting the AC adapter to the camera are inserted securely. The data may be lost if either becomes disconnected while data is being recorded on the SD Memory Card or the built-in memory.
- Use the AC adapter with due care to avoid fire or electric shock. Be sure to read "FOR SAFE USE OF YOUR CAMERA" (p.1) before using the AC adapter.
- Be sure to read the operation manual accompanying the AC adapter kit K-AC8 before using the adapter.
- The battery inside the camera is not charged by connecting the AC adapter to the camera.
- Do not apply excessive pressure to the front or back of the camera when opening and closing the battery/card cover as this may dislodge the waterproof packing. If the packing is not in the correct position, the waterproof performance of the camera will be compromised.

Installing the SD Memory Card

Battery cover lock lever

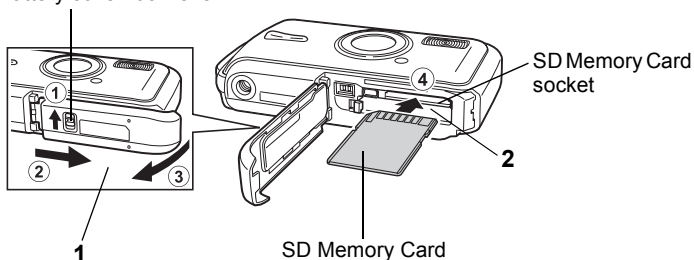

This camera uses an SD Memory Card. Captured images and sound files are saved on the SD Memory Card if a card is inserted in the camera. They are saved in the built-in memory if a card is not inserted. (p.34)



• **Be sure to use this camera to format an SD Memory Card that is unused or has been used on another camera. Refer to “Formatting an SD Memory Card or the Built-in Memory” (p.158) for instructions on formatting.**

- Make sure that the camera is turned off before inserting or removing the SD Memory Card.
- Allow the camera to dry completely before changing the SD Memory Card. Avoid changing the card where the camera is likely to get wet or dirty, and make sure that your hands are dry.
- Do not apply excessive pressure to the front or back of the camera when opening and closing the battery/card cover as this may dislodge the waterproof packing. If the packing is not in the correct position, the waterproof performance of the camera will be compromised.



- The still picture storage capacity varies depending on the capacity of the SD Memory Card and the selected number of recorded pixels and quality level. (p.31)
- The power indicator blinks while the SD Memory Card is being accessed (data is being recorded or read).

Backing Up Data

The camera may not be able to access data in the built-in memory in the case of a malfunction. Use a computer or other device to back up important data in another location.

1 Open the battery/card cover.

Press the battery cover lock lever in the direction of ①, slide the battery/card cover in the direction of ② and flip the cover open in the direction of ③.

2 Insert the SD Memory Card into the SD Memory Card socket so that the label is facing toward the LCD monitor.

Push the card in until it clicks. Images and sound may not be recorded correctly if the card is not inserted all the way.

3 Close the battery/card cover.

Press the battery cover lock lever in the opposite direction to ①. Press it until the red area under the lever cannot be seen.

Removing the SD Memory Card**1 Open the battery/card cover.****2 Push the card into the SD Memory Card socket to eject it.**

Pull the card out.

Precautions When Using an SD Memory Card

- The SD Memory Card is equipped with a write-protect switch. Setting the switch to LOCK protects the existing data by prohibiting recording of new data, deletion of existing data or formatting of the card.  appears on the LCD monitor when the card is write-protected.
- Care should be taken when removing the SD Memory Card immediately after using the camera, as the card may be hot.
- Do not remove the SD Memory Card or turn the camera off while data is being saved to the card, images or sound files are being played back, or the camera is connected to a computer with the USB cable, as this may cause the data to be lost or the card to be damaged.
- Do not bend the SD Memory Card or subject it to violent impact. Keep it away from water and store away from high temperature.
- Do not remove the SD Memory Card during formatting as this may damage the card and render it unusable.
- The data on the SD Memory Card may be deleted in the following circumstances. PENTAX does not accept any liability for data that is deleted
 - (1) when the SD Memory Card is mishandled by the user.
 - (2) when the SD Memory Card is exposed to static electricity or electrical interference.
 - (3) when the card has not been used for a long time.
 - (4) when the card is ejected or the battery is removed while the data on the card is being recorded or accessed.
- The SD Memory Card has a limited service life. If it is not used for a long time, the data on the card may become unreadable. Be sure to regularly make a backup of important data on a computer.
- Avoid using or storing the card where it may be exposed to static electricity or electrical interference.
- Avoid using or storing the card in direct sunlight or where it may be exposed to rapid changes in temperature or to condensation.
- When using an SD Memory Card with a slow recording speed, recording may stop while you are taking movies even when there is adequate space in the memory, or shooting and playback may take a long time.
- For information on compatible SD Memory Cards, visit the PENTAX website or contact your nearest PENTAX Service Center.

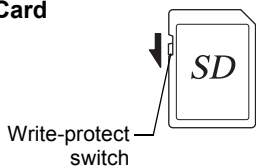

Recorded Pixels and Quality Level of Still Pictures

Choose the number of pixels (size) and quality level (data compression rate) of still pictures according to how you intend to use the pictures you have taken.

Higher quality levels and numbers of pixels produce clearer images, but the resulting increase in data volume reduces the total number of pictures that can be taken (stored in the camera's built-in memory or on the SD Memory Card).

The quality of the captured photo or printed picture also depends on the quality level, exposure compensation, resolution of the printer and a variety of other factors, so you do not need to select more than the required number of pixels. As a rough guide, **2M** (1600×1200) is adequate for making postcard-size prints. Refer to the table below for the appropriate settings according to use.

● Appropriate Number of Recorded Pixels According to Use

Recorded Pixels	Use	
6M 2816×2112	↑ Clearer	For printing high quality photos or A4-size pictures, or editing images on a PC.
5M 2560×1920		
4M 2304×1728		For making postcard-size prints.
3M 2048×1536		
2M 1600×1200		
1280 1280× 960		For posting on a website or attaching to e-mail.
1024 1024× 768		
640 640× 480		

The default setting is **6M** (2816×2112).

- **1280** (1280×960) can only be set for recorded pixels when  mode is set.

● Appropriate Quality Level According to Use

★★★	Best	Lowest compression rate. Suitable for photo prints.
★★	Better	Standard compression rate. Suitable for viewing the image on a computer screen.
★	Good	Highest compression rate. Suitable for posting on a website or attaching to e-mail.

The default setting is ★★ (Better).

Choose the appropriate number of recorded pixels and quality level for still pictures on the [📷 Rec.Mode] menu.

Selecting the Recorded Pixels 📷p.89

Selecting the Quality Level 📷p.91

● Recorded Pixels, Quality Level and Image Storage Capacity (Approximate numbers of pictures)

	★★★ (Best)		★★ (Better)		★ (Good)	
	Built-in Memory	128 MB	Built-in Memory	128 MB	Built-in Memory	128 MB
6M 2816×2112	3 pictures	41 pictures	7 pictures	83 pictures	10 pictures	124 pictures
5M 2560×1920	4 pictures	49 pictures	8 pictures	95 pictures	11 pictures	137 pictures
4M 2304×1728	5 pictures	62 pictures	10 pictures	124 pictures	15 pictures	178 pictures
3M 2048×1536	6 pictures	77 pictures	13 pictures	153 pictures	19 pictures	223 pictures
2M 1600×1200	10 pictures	124 pictures	17 pictures	206 pictures	26 pictures	301 pictures
1280 1280× 960	13 pictures	153 pictures	23 pictures	270 pictures	32 pictures	373 pictures
1024 1024× 768	21 pictures	244 pictures	35 pictures	412 pictures	45 pictures	522 pictures
640 640× 480	42 pictures	489 pictures	61 pictures	712 pictures	84 pictures	979 pictures

- The above figures may vary depending on the subject, shooting conditions, shooting mode and SD Memory Card, etc.
- **1280** (1280×960) can only be set for recorded pixels when 📷 mode is set.

Recorded Pixels, Quality Level and Frame Rate of Movies

Choose the recorded pixels, quality level and frame rate (number of frames per second) according to how you intend to use the movies you have taken.

The higher the number of recorded pixels and quality level, the clearer the details, but the bigger the file size.

The more frames per second, the better the quality of the movie, but the bigger the file size.

Choose the appropriate number of recorded pixels, quality level and frame rate in [Movie] on the [📷 Rec.Mode] menu.

Selecting the Recorded Pixels for Movies 📷p.107

Selecting the Quality Level of Movies 📷p.108

Selecting the Frame Rate 📷p.109

● Appropriate Number of Recorded Pixels According to Use

640 (640×480)	Suitable for viewing on a TV or computer screen.
320 (320×240)	Suitable for posting on a website or attaching to e-mail.

The default setting is **640** (640×480).

● Appropriate Quality Level According to Use

★★★	Best	↑ Clearer images ↓ Grainier images
★★	Better	
★	Good	

The default setting is ★★★ (Best).

● Appropriate Frame Rate According to Use

30fps	Produces high quality movies, but reduces the total recording time.
15fps	Increases the total recording time because the file size is smaller.

The default setting is 30fps (frames per second).

● Recorded Pixels, Quality Level, Frame Rate and Recording Time (Approximate recording time)

		30fps		15fps		Sound	
		Built-in Memory	128 MB	Built-in Memory	128 MB	Built-in Memory	128 MB
640 640×480	★★★	10 sec.	1 min. 56 sec.	19 sec.	3 min. 50 sec.	8 min. 22 sec.	1 hr. 36 min. 59 sec.
	★★	13 sec.	2 min. 36 sec.	26 sec.	5 min. 1 sec.		
	★	20 sec.	3 min. 57 sec.	39 sec.	7 min. 40 sec.		
320 320×240	★★★	16 sec.	3 min. 6 sec.	30 sec.	5 min. 55 sec.		
	★★	21 sec.	4 min. 12 sec.	42 sec.	8 min. 9 sec.		
	★	30 sec.	5 min. 55 sec.	1 min. 1 sec.	11 min. 51 sec.		

- The above figures are based on PENTAX standard shooting conditions and may vary depending on the subject, shooting conditions and type of SD Memory Card used.

Turning the Camera On and Off

1

Getting Started

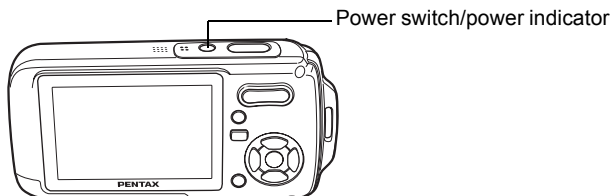

1 Press the power switch.

The camera turns on and the power indicator turns on. If the Initial Setting screen or Date Adjust screen appears when you turn the camera on, follow the procedure on p.36 to set the display language and/or current date and time.

2 Press the power switch again.

The camera turns off and the power indicator turns off.

Taking Pictures p.63

Checking the Memory Card

The memory card is checked automatically when the camera turns on. appears on the LCD monitor when there is no SD Memory Card inserted in the camera. In this case, images and sound files will be saved in the built-in memory.

appears instead of when the write-protect switch on the SD Memory Card is in the locked position. Images and sound cannot be recorded when the write-protect switch is locked.

Memory status



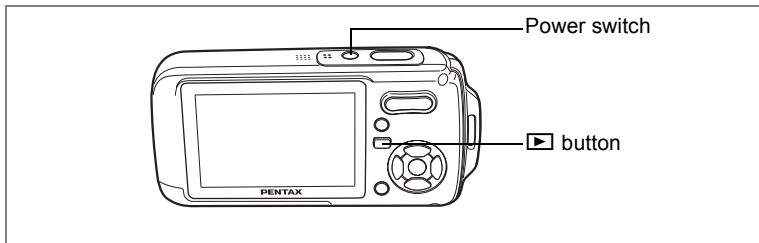

Playback Only Mode

Use this mode when you want to play back an image or sound file straightaway without taking any more pictures.

Pressing the shutter release button does not change the mode to  mode.

1 Press the power switch while holding down the button.

The camera turns on in Playback Only Mode.



To switch from Playback Only Mode to  mode, turn the camera off and then turn it on again.

Playing Back Still Pictures  p.42

Initial Settings

1

Getting Started

Set the language, time, and date after purchasing the camera before you start taking pictures.

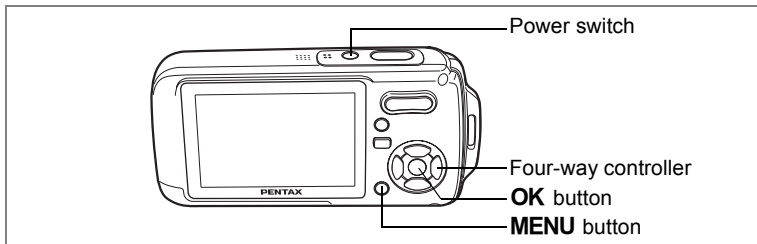

The Initial Setting screen appears when the camera is turned on for the first time. Perform the operations in “Setting the Display Language” below to set the language, and in “Setting the Date and Time” (p.38) to set the current date and time.

Go to “Setting the Date and Time” (p.38) when the Date Adjust screen appears.

Language, Date, and Time can be changed. Refer to the pages below for instructions.

- To change the language, follow the steps in “Changing the Display Language” (p.167).
- To change the date and time, follow the steps in “Changing the Date and Time” (p.159).

Setting the Display Language

1 Press the four-way controller (▶).

The Language/言語 screen appears.

2 Use the four-way controller (▲▼◀▶) to choose the display language.

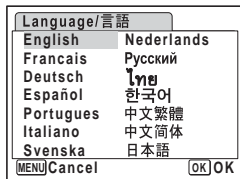

3 Press the OK button.

The Initial Setting screen appears in the selected language. If the desired settings for [Hometown] and daylight saving time appear, press the **OK** button again to display the [Date Adjust] screen. Go to “Setting the Date and Time” (p.38).

Go to Step 4 in “Setting Hometown and DST” if the desired settings do not appear.

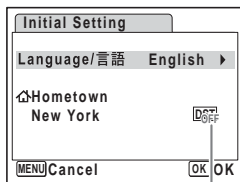

Daylight saving time

If you accidentally select another language and go to the next procedure, perform the following operation to set the language back.

● When Another Language Has Been Inadvertently Selected

- 1 Press the four-way controller (▶).
- 2 Use the four-way controller (▲ ▼ ◀ ▶) to select the language and press the **OK** button.

The Initial Setting screen appears in the selected language.

● When the Screen After Step 3 Appears in Another Language

- 1 Press the **OK** button.
- 2 Press the **MENU** button.
- 3 Press the four-way controller (▶).
- 4 Use the four-way controller (▼ ▲) to select [Language/言語].
- 5 Press the four-way controller (▶).
The Language/言語 screen appears.
- 6 Use the four-way controller (▲ ▼ ◀ ▶) to select the language.
- 7 Press the **OK** button.

The [X Setting] menu appears in the selected language.

The language is now switched to your desired language. To reset Hometown and the Date and Time, refer to the pages below for instructions.

- To change Hometown, follow the steps in “Setting the World Time” (p.165).
- To change the Date and Time, follow the steps in “Changing the Date and Time” (p.159).

Setting Hometown and DST

- 4 Press the four-way controller (▼).**
The frame moves to [Hometown].
- 5 Press the four-way controller (▶).**
The Hometown screen appears.
- 6 Use the four-way controller (◀▶) to choose the city.**
- 7 Press the four-way controller (▼).**
The frame moves to [DST] (Daylight Saving Time).
- 8 Use the four-way controller (◀▶) to select (On) or (Off).**
- 9 Press the OK button.**
The Initial Setting screen appears.
- 10 Press the OK button.**
The Date Adjust screen appears. Next, set the date and time.

Setting the Date and Time

Set the current date and time and the display style.

- 1 Press the four-way controller (▶).**
The frame moves to [mm/dd/yy].
- 2 Use the four-way controller (▲▼) to choose the date and time display style.**
- 3 Press the four-way controller (▶).**
The frame moves to [24h].
- 4 Use the four-way controller (▲▼) to select [24h] (24-hour display) or [12h] (12-hour display).**
- 5 Press the four-way controller (▶).**
The frame returns to [Date Style].

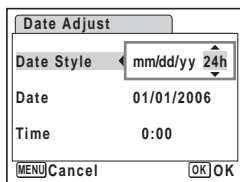
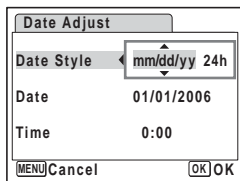

6 Press the four-way controller (▼).

The frame moves to [Date].

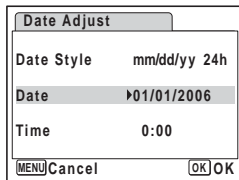

7 Press the four-way controller (▶).

The frame moves to the month.

8 Use the four-way controller (▲▼) to change the month.

Change the day and year in the same manner. Next, change the time.

If you selected [12h] in Step 4, the setting switches between am and pm corresponding to the time.

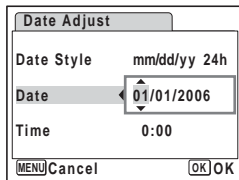

9 Press the OK button.

The setting is set and the camera returns to capture status.

Language, Date, Time, Hometown, and DST can be changed. Refer to the pages below for instructions.

- To change the language, follow the steps in “Changing the Display Language” (p.167).
- To change the date and time, follow the steps in “Changing the Date and Time” (p.159).
- To change the city or turn DST on and off, follow the steps in “Setting the World Time” (p.165).



When the Initial Setting or Date Adjust screen is displayed, you can cancel the setting operation and switch to Capture mode by pressing the **MENU** button. In this case, the Initial Setting screen will appear next time you turn the camera on.



If you press the **OK** button in Step 9, the camera clock is reset to 00 seconds. To set the exact time, press the **OK** button when the time signal (on the TV, radio, etc.) reaches 00 seconds.

The video output format is set to the format of the country or region selected in [Language/言語] on the Initial Setting screen. You can change the setting. (p.170)

Taking Still Pictures

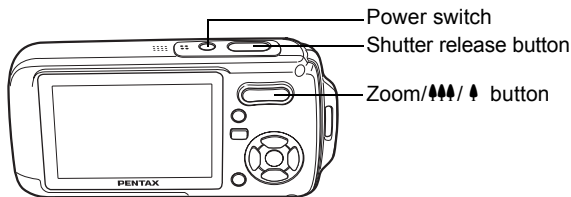

The standard procedure for taking still pictures is described below. The flash fires automatically depending on the light conditions.

1 Press the power switch.

The camera turns on and is ready to take still pictures. In this manual, this is called Still Picture Capture mode.

2 Confirm the subject and shooting information on the LCD monitor.

The focus frame in the middle of the LCD monitor indicates the zone of automatic focusing.



Focus frame

You can change the captured area by pressing the Zoom/▲▲▲/▲ button to the left or right.

▲ : enlarges the subject

▲▲▲ : widens the area that is captured by the camera

3 Press the shutter release button halfway.

The focus frame on the LCD monitor turns green if the subject is in focus.

4 Press the shutter release button fully.

The picture is taken.

The image appears on the LCD monitor for one second (Instant Review) and is saved to the SD Memory Card or built-in memory. (p.41)



Press the Green button to switch to the Green Mode and let the camera set all the shooting functions automatically. Selecting the Green Mode is the easiest way to ensure that pictures come out well. (p.64)

Using the Shutter Release Button

The shutter release button works in a two-step action as follows.

Press halfway

The focus and exposure are locked when the shutter release button is pressed halfway. The green focus frame lights on the LCD monitor when the shutter release button is pressed halfway and the subject is in focus. If the subject is out of focus, the frame will light red.

Press fully

Press the shutter release button all the way down to take the picture.

[Poor focusing conditions]

The camera may not be able to focus under the following conditions. In this case, lock the focus on an object the same distance away as the subject (by pressing the shutter release button halfway), then aim the camera at your subject and press the shutter release button fully.

- Objects that lack contrast such as a blue sky or white wall
- Dark places or objects, or conditions that prevent light being reflected back
- Horizontal lines or intricate patterns
- Fast moving objects
- When there is an object in the foreground and an object in the background in the same picture
- Strongly reflected light or strong backlighting (bright background)

Instant Review

The image appears on the LCD monitor for one second (Instant Review) immediately after it is captured. You can change the Instant Review time. (p.99)

You can delete the image during Instant Review by pressing the  button.

Playing Back Still Pictures

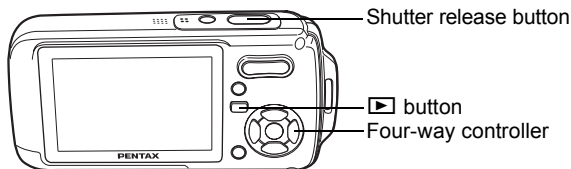

Playing Back Images

- 1 **Press the ▶ button after taking a picture.**

The image appears on the LCD monitor. In this manual, this is called ▶ mode (Playback mode). Displaying one image in full in ▶ mode (▶ mode default setting) is called single-image display.

Press the ▶ button again in ▶ mode or press the shutter release button halfway to switch to mode.

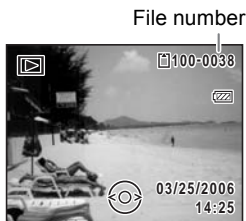

Playing Back the Previous or Next Image

- 1 **Press the ▶ button after taking a picture.**
The image appears on the LCD monitor.
- 2 **Press the four-way controller (◀▶).**
The previous or next image appears.

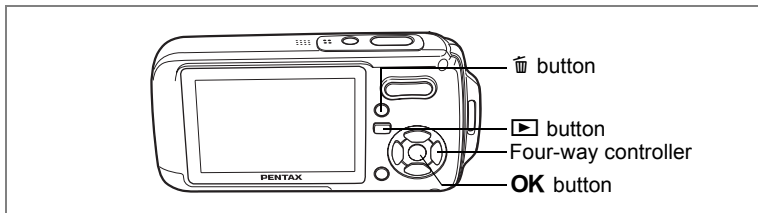

Rotating the Displayed Image

- 1 Press the button after taking a picture.**

The image appears on the LCD monitor.

- 2 Press the four-way controller ().**

The Playback Mode Palette appears.

- 3 Use the four-way controller () to select (Image Rotation) and press the OK button.**

The rotation selection screen (0°, Right 90°, Left 90°, or 180°) appears.

- 4 Use the four-way controller () to choose the rotation direction and press the OK button.**

The rotated image appears.

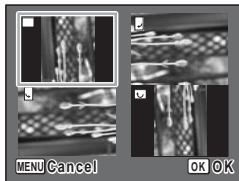

- Movies cannot be rotated.
- Protected images can be rotated, but they cannot be saved in a rotated state.

Deleting the Displayed Image



Press the button while the image is displayed to display the Delete screen. Use the four-way controller () to select [Delete] and press the OK button. (p.123)

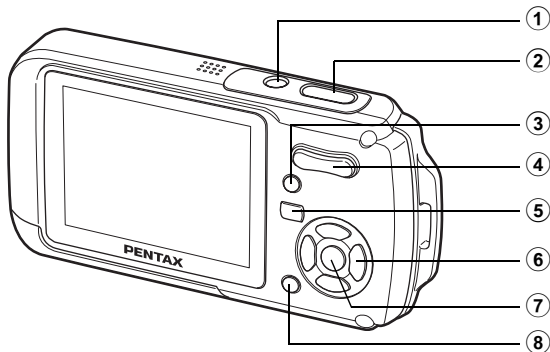

Understanding the Button Functions



Mode

- ① **Power switch**
Turns the camera off. (p.34)
- ② **Shutter release button**
Focuses the camera on the subject when pressed halfway in Still Picture Capture mode. (Except in **▲**, **PF** and **MF** modes) (p.40)
Takes the still picture when pressed down fully. (p.40)
Starts and stops movie recording in **MOVIE** mode. (p.105)
Starts and stops sound file recording in **RECORD** mode. (p.153)
- ③ **Green button**
Switches to the Green Mode. (p.64)
Calls up the assigned menu. (p.58)
Displays an explanation of the function selected on the Capture Mode Palette. (p.62)
Takes a still picture during movie recording. (p.106)
- ④ **Zoom/**▲▲▲**/**▲**/**□**/**Q** button**
Changes the captured area. (p.80)
- ⑤ ** button**
Switches to the  mode. (p.113)

⑥ **Four-way controller**

- (▲) : Changes the drive mode. (p.76, p.77, p.78)
- (▼) : Displays the Capture Mode Palette. (p.53)
- (◀) : Changes the flash mode. (p.87)
- (▶) : Changes the focus mode. (p.85)
- (▲▼) : Adjusts **MF** in **MF** mode. (p.86)

⑦ **OK/DISPLAY button**







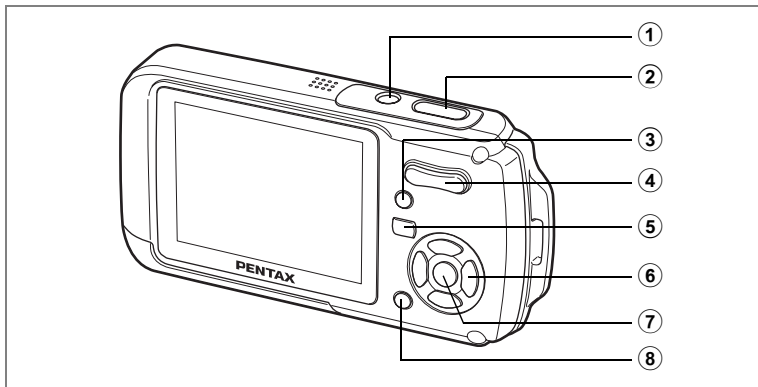



Changes the information displayed on the LCD monitor. (p.83)



⑧ **MENU button**

Displays the [📷 Rec.Mode] menu. (p.48)



▶ Mode

- ① **Power switch**
Turns the camera off. (p.34)
- ② **Shutter release button**
Switches to  mode. (p.113)
- ③ **Green/  button**
Switches from single-image display to the Delete screen. (p.123)
Switches from nine-image display to the Select & Delete screen. (p.125)
Displays a guide of the function selected on the Playback Mode Palette. (p.62)
Switches from folder display to the calendar display screen. (p.115)
Switches from calendar display to the folder display screen. (p.115)
- ④ **Zoom/  /  button**
Press  during single-image display to change to nine-Image display.
Returns to the previous display when  is pressed. (p.114)
Enlarges the image when  is pressed during single-image display.
Returns to the previous display when  is pressed. (p.116)
Press  during nine-image display to change to folder or calendar display. (p.115)
Press  during folder display to change to nine-image display of the selected folder. (p.115)
Press  during calendar display to change to nine-image display for the selected date. (p.115)
Can be used to adjust the volume during playback of movies or sound files. (p.121, p.155)

- ⑤ **▶ button**
Switches to  mode. (p.113)
- ⑥ **Four-way controller**
- (▲) : Plays back and pauses a movie or sound file. (p.121, p.155)
 - (▼) : Displays the Playback Mode Palette. (p.61)
Stops a movie or sound file during playback. (p.121, p.155)
 - (◀▶) : Displays the previous or next image and sound file during single-image display. (p.42)
Frame forwards, frame reverses and reverses a movie during playback. (p.121)
Fast forwards, reverses, and moves to the index in sound file playback. (p.155)
 - (▲▼◀▶) : Moves the display area during zoom display. (p.116)
Selects an image in nine-image display, a folder in folder display, and a date in calendar display. (p.114, p.115)
Moves the image when using the Frame Composite function. (p.139)
- ⑦ **OK/DISPLAY button**
Changes the information displayed on the LCD monitor. (p.118)
Returns zoom display or nine-image display to single-image display. (p.114, p.116)
Changes to nine-image display of the selected folder during folder display. (p.115)
Changes to single-image display of the selected date during calendar display. (p.115)
- ⑧ **MENU button**
Displays the [ Setting] menu during single-image display. (p.48)
Returns to single-image display during Playback Mode Palette display. (p.60)
Returns zoom display or nine-image display to single-image display. (p.114)
Changes to nine-image display of the selected folder during folder display. (p.115)
Changes to nine-image display of the selected date during calendar display. (p.115)

Setting the Camera Functions

To change the camera settings, press the **MENU** button to display the [📷 Rec.Mode] menu or [⚙️ Setting] menu. Menus for playing back and editing images and sound files are displayed from the Playback Mode Palette.

Setting with the Menus

Press the **MENU** button in 📷 mode to display the [📷 Rec.Mode] menu. Press the **MENU** button in ▶ mode to display the [⚙️ Setting] menu.

During recording

During playback

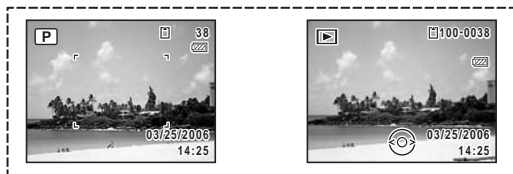

MENU

MENU

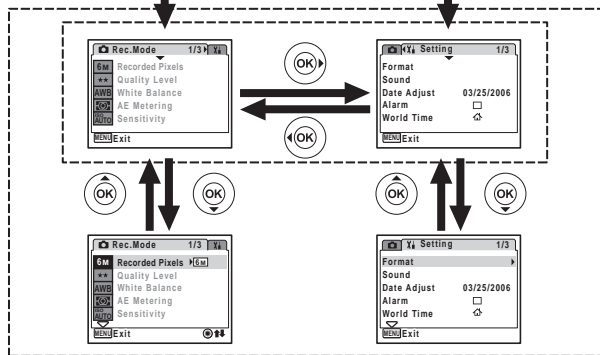

SHUTTER
Press halfway

MENU, OK or ▶

The setting is complete and the camera returns to 📷 mode



The setting is complete and the camera returns to ▶ mode





A guide to available button operations appears on the LCD monitor during menu operation.

Ex.) To set the [Quality Level] on the [Rec.Mode] menu

1 Press the MENU button in camera mode.

The [Rec.Mode] menu appears.

2 Press the four-way controller (▼).

The frame moves to [Recorded Pixels].

3 Press the four-way controller (▼).

The frame moves to [Quality Level].

4 Press the four-way controller (▶).

A pull-down menu appears with the items that can be selected.

The pull-down menu displays only those items that can be selected with the current camera settings.

5 Use the four-way controller (▲▼) to change the setting.

The quality level changes each time the four-way controller (▲▼) is pressed.

Refer to the following page for instructions on saving settings and canceling changes.

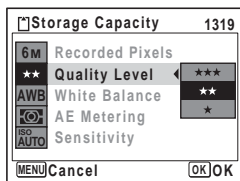
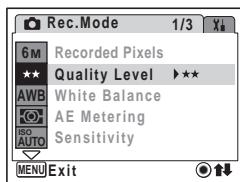
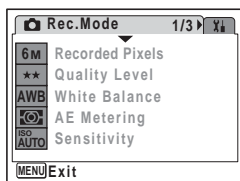

To Save the Setting and Start Taking Pictures

6 Press the shutter release button halfway.

The setting is saved and the camera returns to capture status.
When the shutter release button is pressed fully, the picture is taken.

To Save the Setting and Begin Playback of Images

6 Press the button.

The setting is saved and the camera returns to playback status.

To Save the Setting and Continue with Menu Operations

6 Press the OK button or the four-way controller (◀).

The setting is saved and the screen returns to Step 3.

To Cancel the Changes and Continue with Menu Operations

6 Press the MENU button.

The changes are canceled and the screen returns to Step 3.

The **MENU** button function differs depending on the screen. Refer to the guide indications.

 Exit : Exits the menu and returns to the original screen.

  : Returns to Step 3 with the current setting.

 Cancel : Cancels the current selection, exits the menu and returns to Step 3.

Menu List

This displays the items that can be set with the menus and provides descriptions of each item. See the list of default settings in the Appendix “Default Settings” (p.180) to decide whether you want the settings saved when the camera is turned off and whether you want the settings returned to the defaults when the camera is reset.

[📷 Rec.Mode] Menu

This menu shows the functions related to taking still pictures and recording movies.

Item		Description	Page
Recorded Pixels		For choosing the number of recorded pixels of still pictures	p.89
Quality Level		For choosing the quality level of still pictures	p.91
White Balance		For adjusting the color balance according to the light conditions	p.92
AE Metering		For setting the area of the screen where the brightness is metered to determine the exposure	p.94
Sensitivity		For setting the sensitivity	p.96
EV Compensation		For adjusting the overall brightness of the picture	p.82
AF Setting	Focusing Area	For changing the area of the autofocus	p.97
	Focus Limiter	For limiting the lens movement area according to the conditions	p.98
Movie	Recorded Pixels	For choosing the number of recorded pixels of movies	p.107
	Quality Level	For choosing the quality level of movies	p.108
	Frame Rate	For setting the frame rate (number of frames per second)	p.109
	Color Mode	For choosing a color mode for movies	p.110
	Movie anti-shake	For choosing whether to use the movie anti-shake function	p.111
	Optical Zoom	For choosing whether to use the optical zoom function for movies	p.112
Interval Shoot	Interval	For setting the interval for shooting	p.78
	Number of Shot	For setting the number of shots taken	p.78
	Start Time	For setting the start time for interval shooting	p.78
Digital Zoom		For choosing whether to use the digital zoom function	p.81
Instant Review		For setting the Instant Review time	p.99
Memory		For choosing whether to save the set values of the shooting function or return to the defaults when the camera is turned off	p.103
Sharpness		For choosing sharp or soft outlines	p.100
Saturation		For setting the color saturation	p.101
Contrast		For setting the image contrast level	p.102



- Use the Green Mode to enjoy easy picture-taking using standard settings, regardless of the settings in the [📷 Rec.Mode] menu. (p.64)
- Assigning frequently used functions to the Green button enables you to go straight to the menu. (p.58) You can also change the order of the menu items, so that you can put frequently used items on top of less used ones. (p.175)

[X] Setting Menu

Item	Description	Page	
Format	For formatting the SD Memory Card or built-in memory	p.158	
Sound	For adjusting the playback volume and setting the start-up sound, shutter sound, key operation sound and self-timer sound	p.161	
Date Adjust	For adjusting the date, time, and date and time styles	p.159	
Alarm	For setting the alarm	p.163	
World Time	For setting the world time	p.165	
Language/言語	For setting the language in which menus and messages appear	p.167	
Folder Name	For choosing how names are assigned to folders for storing images and sound files	p.168	
USB Connection	For setting the USB cable connection (to PC or printer)	p.169	
Video Out	For setting the output format to the AV equipment	p.170	
Brightness Level	For changing the brightness of the LCD monitor	p.171	
Power Saving	For setting the time until the camera enters power-saving mode	p.172	
Quick Zoom	For displaying an image at maximum magnification by pressing on the Zoom// button during still picture playback	p.117	
Green Button	For assigning a function to the Green button in Capture mode	p.58	
Auto Power Off	For setting the time until the camera turns off automatically	p.173	
Reset	Reset menu setting	For returning settings other than the date and time, language, world time, video out and menu order to their defaults	p.176
	Reset menu item order	For resetting the menu order to its default	p.176

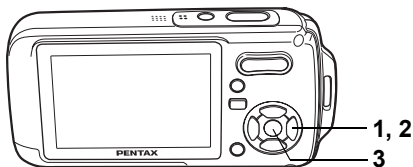

Setting the Shooting Mode

The Optio W10 has a variety of shooting modes that let you take pictures or record movies and sound in different situations simply by choosing the right mode for the particular situation from the Capture Mode Palette.

1 Press the four-way controller (▼) in mode.

The Capture Mode Palette appears.

2 Use the four-way controller (▲▼◀▶) to choose a shooting mode.

Choose a shooting mode and press the Green button to display a guide of the shooting mode. (p.62)



3 Press the OK button.

The shooting mode is selected and the camera returns to capture status.



- In shooting modes other than , , , and , the flash, focus, saturation, contrast, sharpness, white balance, etc. are automatically set to the optimal settings for each mode.
- Some functions may not be available or may not function fully depending on the shooting mode. For details, refer to “Functions Available for Each Shooting Mode” (p.183).

There are 25 available shooting modes.

① **P Program**

The basic picture-taking mode. You can let the camera set the functions or choose various functions yourself. (p.63)

② **Night Scene**

Ideal for taking night views. It is best to use a tripod in this mode. Use the flash if including people in your picture. (p.66)



③ **Movie**

Use this mode for taking movies. Sound is recorded at the same time. (p.105)

④ **Voice Recording**

Use this mode to record sound files. Be careful not to cover the microphone on the top of the camera with your hand. (p.153)

⑤ **Frame Composite**

Use this mode to take pictures with a frame. The number of recorded pixels is fixed at **3M**. (p.67)



⑥ **Landscape**

Use this mode for taking landscape views. The depth of field encompasses a wide area.



⑦ **Flower**

Use this mode for taking bright, colorful pictures of flowers with soft outlines.



8

Portrait

Use this mode for taking pictures of people. Gives your subject a bright, healthy look.



9

Underwater

Use this mode for taking pictures underwater. Captures the blueness of the sea. (p.72)



10

Underwater Movie

Use this mode to record movies underwater. Captures the blueness of the sea. (p.72)



11

Surf & Snow

For capturing images with dazzling backgrounds, such as beaches or snowy mountains.



12

Synchro Sound Record

Automatically records the sound 10 sec. before and after the shutter is released. (p.74)

13

Sport

Ideal for taking fast-moving action shots. The camera keeps the moving subject in focus until the shutter release button is pressed.



14 🐾 **Pet**

Ideal for taking pictures of pets. The camera keeps the moving pet in focus until the shutter release button is pressed. You can select settings according to the color of your pet's coat. (p.70)

**15** 🕯️ **Candlelight**

Ideal for capturing a candlelit atmosphere. (p.66)

**16** 👶 **Kids**

Ideal for taking pictures of children who are moving around. Gives your subject a bright, healthy look.

**17** **SOFT Soft**

For taking pictures with soft, blurred outlines.

**18** 📷 **Self-portrait**

Use this mode to take pictures of yourself or include yourself in pictures. The camera adjusts the focus and color.

**19** 🎆 **Fireworks**

Use this mode to take spectacular pictures of fireworks. It is best to use a tripod as the shutter speed is fixed at 4 sec. (p.66)



20  **Sunset**

For taking beautiful pictures of sunsets. This mode can also be used to capture sunrises.

**21**  **Food**

Use this mode for taking pictures of food. The increased saturation gives pictures a bright, vivid finish.

**22**  **Text**

Use this mode to take clear pictures of text. You can change the image to black and white or reverse the colors. (p.75)

Over the years PENTAX distinguished itself as a leader in the photographi industry. Today PENTAX proud to manufacture a v variety of cameras, lense flashes and photo ories.

23  **Museum**

For taking pictures in museums and art galleries where flash photography is not permitted. Take care to avoid camera shake.

**24**  **Natural Skin Tone**

Adjusts the color and brightness to reproduce skin tone more beautifully than Portrait mode.

**25**  **Report**

For capturing image with fixed 1280×960 pixels for reports.





Choose a shooting mode and press the Green button to display a guide of the shooting mode. (p.62)

Calling Up a Specific Menu

When you assign functions to the Green button, pressing the Green button displays the menus one after another. This is useful for going straight to the setting screens of frequently used functions such as EV Compensation, Sensitivity and White Balance.

3

Common Operations



- The following functions can be assigned to the Green button: Green Mode, Recorded Pixels, Quality Level, White Balance, AE Metering, Sensitivity, EV Compensation, Focusing Area, Sharpness, Saturation and Contrast.
- The default setting is Green Mode in [1] and no function in [2], [3] or [4].
- The Green Button setting can be returned to the default setting by selecting [Reset] on the [X] Setting] menu.
- The functions assigned to the Green button can be used in the usual manner on the original menu ([Rec.Mode] and [X] Setting]).
- You cannot save different settings for the same function on the Green button and on the original menu.

Assigning a Function to the Green Button

- 1 Select [Green Button] on the [X] Setting] menu.**
- 2 Press the four-way controller (▶).**
The Green Button screen appears.
- 3 Use the four-way controller (▲ ▼) to choose a number.**

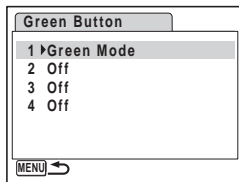

4 Press the four-way controller (▶).

A pull-down menu appears.

5 Choose a function and press the OK button.

6 Repeat Steps 3 to 5 to register the necessary functions.

7 Press the MENU button twice.

The camera returns to capture status with the current setting.

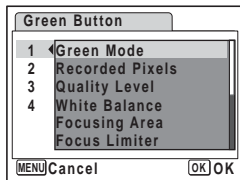

Using the Green Button

1 Press the Green button in mode.

The function assigned to [1] in [Green Button] on the [Fn Setting] menu is called up.



Next function assigned to Green button

2 Press the Green button again.

The function assigned to [2] is called up. While the screen at right is displayed, use the Green button to recall functions allocated to [3] and [4].



3 Change the settings and press the OK button.

The camera returns to capture status.



- If the Green Mode has been assigned to the Green button, the camera enters the Green Mode one second after the Green button is pressed (p.64).
- If a function other than the Green Mode has been assigned to the Green button, the camera returns to the original screen if no operation is performed for five seconds after the Green button is pressed.







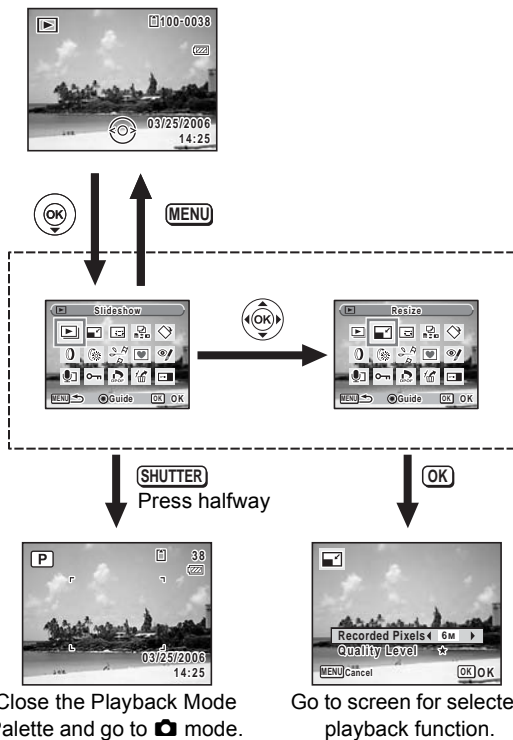







Setting the Playback Mode

Press the four-way controller (▼) in Playback mode to display the Playback Mode Palette.

You can display the playback function you want to use simply by using the four-way controller (▲▼◀▶) to choose an icon and pressing the **OK** button.



Playback Mode Palette

Item		Description	Page
	Slideshow	For playing back recorded images one after another	p.119
	Resize	For changing the recorded pixels and quality of images	p.131
	Trimming	For deleting the unneeded part of a picture	p.133
	Image/Sound Copy	For copying images and sound files from the built-in memory to the SD Memory Card and vice versa	p.134
	Image Rotation	For rotating still pictures	p.43
	Digital Filter	For changing the color of still pictures	p.136
	Brightness Filter	For changing the brightness of still pictures	p.137
	Movie Edit		
	Save as Still image	For saving one frame from a movie as a still picture	p.142
	Divide Movies	For dividing a movie into two	p.143
	Stitch Movies	For joining two movies together	p.144
	Frame Composite	For adding a decorative frame to a still picture	p.139
	Red-eye Compensation	For correcting still pictures where the flash has caused the subject to appear with red eyes	p.138
	Voice Memo	For adding a voice memo to still pictures	p.156
	Protect	For protecting images and sound files from accidental deletion	p.129
	DPOF	For setting the DPOF print order data for still pictures	p.145
	Image Recovery	For recovering deleted images	p.128
	Start-up Screen	For setting the start-up screen	p.174

Viewing a Guide of the Shooting and Playback Modes

Selecting a mode on the Capture Mode Palette or Playback Mode Palette and pressing the Green button displays an explanation of the selected item.

1 Press the four-way controller (▼) in mode.

The Capture Mode Palette appears.

Press the four-way controller (▼) in  mode to display the Playback Mode Palette.

2 Use the four-way controller (▲▼◀▶) to choose a shooting mode.



3 Press the Green button.

A guide of the selected shooting mode appears.

4 Press the OK button.

The camera returns to capture status with the selected shooting mode.

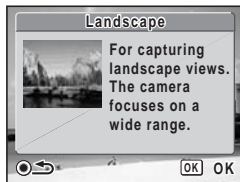

Press the Green button while the guide is displayed to return to the Capture Mode Palette or Playback Mode Palette.

Taking Pictures

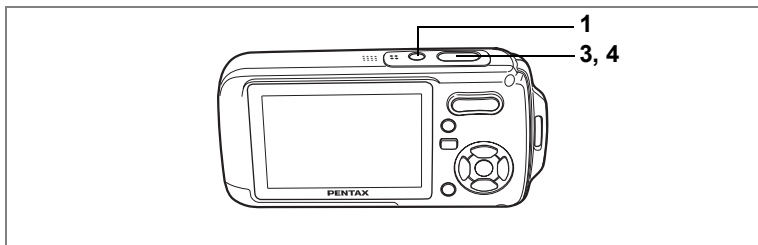

P

Letting the Camera Choose the Optimal Settings (Program Mode)

In **P** (Program mode), the camera automatically sets the shutter speed and aperture for taking still pictures. However, you can select other functions such as the flash mode and recorded pixels.

- 1 Press the power switch.**
- 2 Set the functions you want to use.**
- 3 Press the shutter release button halfway.**

The camera turns on and is ready to take still pictures.

Refer to “Setting the Shooting Functions” (p.85 - p.102) for details of how to set the functions.

The focus frame on the LCD monitor turns green if the subject is in focus.

- 4 Press the shutter release button fully.**

The picture is taken.



If a shooting mode other than **P** mode has been selected, select **P** mode from the Capture Mode Palette. (p.53)

Taking Still Pictures p.40

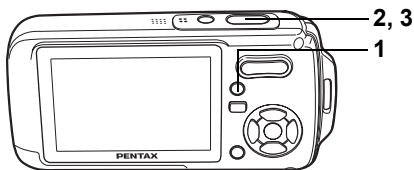

Taking Pictures in the Basic Mode (Green Mode)

In the Green Mode, you can enjoy easy picture-taking using standard settings*, regardless of the settings in the [📷 Rec.Mode] menu.

4

Taking Pictures

1 Press the Green button in 📷 mode.

The camera switches to the Green Mode. Press the Green button again to return to the status before the Green Mode was selected.

2 Press the shutter release button halfway.

The focus frame on the LCD monitor turns green if the subject is in focus.



Key lock icon







3 Press the shutter release button fully.

The picture is taken.



- If any other functions have been assigned to the Green button, the menus appear in sequence each time the button is pressed. (p.59)
- In Green Mode, you cannot change the information displayed on the LCD monitor by pressing the **OK/DISPLAY** button.
- You cannot use the [📷 Rec.Mode] menu or Capture Mode Palette in Green Mode. If you try to display the [📷 Rec.Mode] menu or Capture Mode Palette, 🔒 (key lock icon) appears.
- If you switched to ▶ mode from Green Mode, you cannot display the [X↓ Setting] menu by pressing the **MENU** button. If you try to display the [X↓ Setting] menu, 🔒 (key lock icon) appears.
- When the camera is turned off in the Green Mode, it turns on in the Green Mode next time the power switch is pressed.

* The Green Mode settings are as shown below.

Flash Mode	 (Auto)
Drive Mode	<input type="checkbox"/> (Standard)
Focus Mode	AF (Standard)
Information Display	Normal
Recorded Pixels	
Quality Level	★★ (Better)
White Balance	AWB (Auto)
Focusing Area	 (Multiple)
Focus Limiter	<input checked="" type="checkbox"/> (On)
Sensitivity	Auto
EV Compensation	±0.0
Digital Zoom	<input checked="" type="checkbox"/> (On)
Instant Review	1sec
Sharpness	 (Normal)
Saturation	 (Normal)
Contrast	 (Normal)

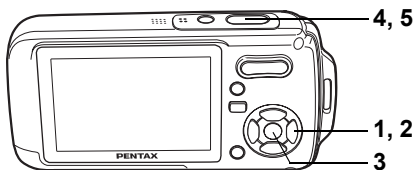

Taking Pictures of Dark Scenes (Night Scene/Candlelight/Fireworks Mode)

4

You can choose settings appropriate for taking pictures of dark scenes, such as nightscapes.

	Use this mode when taking pictures of night views.
	This mode is ideal for capturing a candlelit atmosphere.
	Use this mode to take spectacular pictures of fireworks.

1 Press the four-way controller (▼) in mode.

The Capture Mode Palette appears.

2 Use the four-way controller (▲▼◀▶) to select (Night Scene), (Candlelight) or (Fireworks).

3 Press the OK button.

The shooting mode is selected and the camera returns to capture status.

4 Press the shutter release button halfway.

The focus frame on the LCD monitor turns green if the subject is in focus.

5 Press the shutter release button fully.

The picture is taken.



- The shutter speed is slower when taking pictures of dark scenes.
- To prevent camera shake, use a tripod and the self-timer function. (p.76)
- In mode, the sensitivity is automatically adjusted to between 64 and 800 when set to [Auto]. (p.96)
- The sensitivity is set at 64, the focus mode is set to ▲, and the flash mode is set to in mode. In addition, the shutter speed is set at 4 sec. and the aperture is left open, and EV compensation is not available.
- In , or mode, AE metering is set to multi-segment metering.

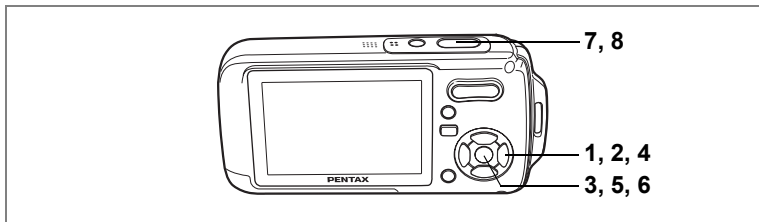

Framing Your Pictures (Frame Composite)

In this mode you can take pictures using the frames stored in the camera.

1 Press the four-way controller (▼) in mode.

The Capture Mode Palette appears.

2 Use the four-way controller (▲▼◀▶) to select (Frame Composite).

3 Press the OK button.

A 9-frame display of the frame selection screen appears.

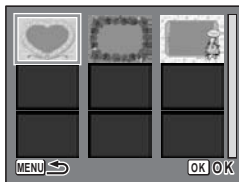

4 Use the four-way controller (▲▼◀▶) to choose the frame you want to use.

5 Press the OK button.

The selected frame appears in single-image display. You can choose another frame using either of the following operations.

- Use the four-way controller (◀▶) to choose a different frame.
- Press the **MENU** button or on the Zoom//Q button to return to the 9-frame display of the frame selection screen, and then perform Step 4 to choose a different frame.



6 Press the OK button.

The frame appears on the screen.

7 Press the shutter release button halfway.

The focus frame on the LCD monitor turns green if the subject is in focus.

8 Press the shutter release button fully.

The picture is taken.

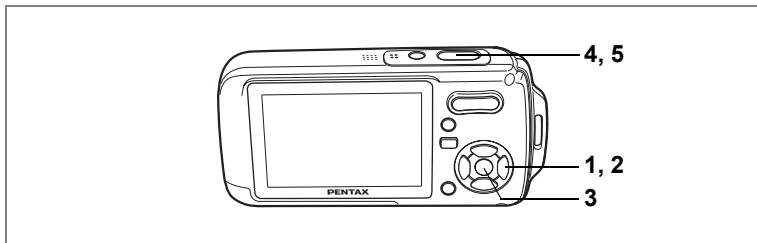

Taking Pictures of People (Portrait/Self-portrait/ Natural Skin Tone)

In , or mode, Face Recognition AF and Face Recognition AE are activated. Simply point the camera toward your subject's face and the camera automatically recognizes the location of the subject's face, adjusts the focus (using Face Recognition AF) and the exposure (using Face Recognition AE) and allows you to take a picture.

	Use this mode when taking pictures of people.
	Use this mode when taking self-portraits or pictures of you and a friend.
	Use this mode when you want to enhance the natural skin tone of the people in your pictures.

- 1 Press the four-way controller (▼) in mode.**
The Capture Mode Palette appears.
- 2 Use the four-way controller (▲▼◀▶) to select (Portrait), (Self-portrait) or (Natural Skin Tone).**
- 3 Press the OK button.**

The shooting mode is selected and the camera returns to capture status. When the location of the subject's face is recognized, a yellow focus frame appears on the LCD monitor at the location of the face. As the subject moves, the size and location of the focus frame change to match the location of the subject's face.

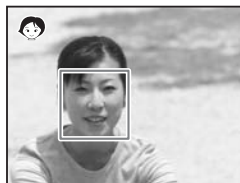

- 4 Press the shutter release button halfway.**
The focus frame on the LCD monitor turns green if the subject is in focus.
- 5 Press the shutter release button fully.**
The picture is taken.



- If the camera cannot recognize the location of the subject's face, the camera focuses using the normal Focusing Area (Multiple).
- The digital zoom function cannot be used in , or mode.
- Continuous Shooting cannot be used in , or mode.
- In , or mode, only , or and the focus frame appear on the LCD monitor. No other shooting information is displayed. In addition, you cannot change the information displayed on the LCD monitor by pressing the **OK/DISPLAY** button.
- Face Recognition AF and Face Recognition AE may not work if the subject is wearing sunglasses or has part of the face covered or if the subject is not looking toward the camera.
- In , or mode, AE metering is set to multi-segment metering.

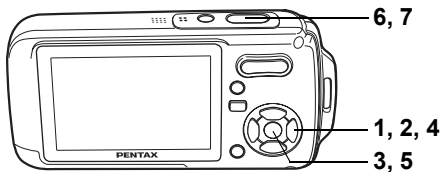

Taking Pictures of Your Pet (Pet Mode)

Use this mode to keep your moving pet in focus while you take the picture and capture the color of your pet's coat. Choose the appropriate icon depending on what color your pet is (closer to black or white or in between).

- 1 Press the four-way controller (▼) in mode.**
The Capture Mode Palette appears.
- 2 Use the four-way controller (▲▼◀▶) to select (Pet).**

- 3 Press the OK button.**

The Pet mode selection screen appears.

- 4 Use the four-way controller (▲▼) to select , , , , or .**

There are two types of icons: a cat and dog icon.

(Choosing either the cat or dog icon does not affect the resulting picture. Choose whichever you prefer.)



- 5 Press the OK button.**

The Pet mode is selected and the camera returns to capture status.

- 6 Press the shutter release button halfway.**

The focus frame on the LCD monitor turns green if the subject is in focus.

The focus frame follows the pet while the shutter release button is pressed halfway.



7 Press the shutter release button fully.

The picture is taken.



In  mode, AE metering is set to multi-segment metering.

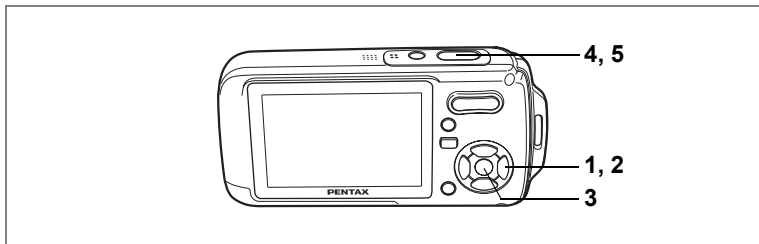

Taking Underwater Pictures (Underwater Mode/Underwater Movie Mode)

4

This camera has been proven to comply with JIS Class 8 (IP58) waterproof performance and can be used to take pictures at a depth of 1.5 m continuously for 30 minutes. In addition, this camera complies with JIS Class 5 dustproof performance (IP58).

Taking Pictures

	Use the Underwater mode to take underwater still pictures that capture the blueness of the sea.
	Use the Underwater Movie mode to record movies underwater.

1 Press the four-way controller (▼) in mode.

The Capture Mode Palette appears.

2 Use the four-way controller (▲▼◀▶) to select (Underwater) or (Underwater Movie).

3 Press the OK button.

The shooting mode is selected and the camera returns to capture status. If you selected , go to Step 5.

4 Press the shutter release button halfway.

The focus frame on the LCD monitor turns green if the subject is in focus.

5 Press the shutter release button fully.

If you selected , the picture is taken.

If you selected , recording starts. To stop recording, press the shutter release button fully. Perform the same steps as to record movies.

Recording a Movie p.105



- Before taking pictures underwater, make sure that there is no dirt or sand on the waterproof packing of the battery/card cover and check that the cover is securely locked. (p.23)
- Before opening the battery/card cover after using the camera underwater, make sure that there is no water, dirt or sand on the battery/card cover or anywhere on the camera. Wipe the camera before opening the cover.
- In mode, AE metering is set to multi-segment metering.

Waterproof and Dustproof Function p.5



- The flash will not discharge in mode.
- In mode, the default setting for focus mode is **PF**. (p.85)
The focus mode can be changed before recording starts.
- When the Focus Mode is set to **MF**, you can adjust the focus before recording starts and during recording.
- You can use the optical zoom and digital zoom before recording starts and during recording.
- Changing the LCD monitor display mode by pressing the **OK/DISPLAY** button while recording a movie will not display the histogram.

Setting the Optical Zoom p.112

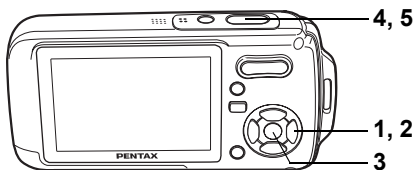

Taking Still Pictures with Sound (Synchro Sound Record)

A total of 20 seconds, the 10 seconds before and after the shutter release button is pressed fully, of sounds are recorded with the still picture.

- 1 Press the four-way controller (▼) in mode.**
The Capture Mode Palette appears.
- 2 Use the four-way controller (▲▼◀▶) to select .**
(Synchro Sound Record).
- 3 Press the OK button.**
The Synchro Sound Record mode is selected and the camera returns to capture status.
- 4 Press the shutter release button halfway.**
The focus frame on the LCD monitor turns green if the subject is in focus.
- 5 Press the shutter release button fully.**
The picture is taken.
A countdown of the remaining recording time appears on the Instant Review screen.



- You can play back sound recorded in Synchro Sound Record mode in the same way as playing a voice memo. (p.157)
- In Synchro Sound Record mode, the default setting for focus mode is **PF** (Pan Focus). (p.85)
- Sound recording before taking a picture starts immediately when Synchro Sound Record mode is selected. Ten seconds of sound before the shutter release button is pressed fully are recorded with the still picture. Sound prior to this is not recorded.
- The shutter sound, operation sound, and self-timer sound are muted when the Synchro Sound Record mode is set.
- If you press the shutter release button fully while the camera is recording sound after taking the picture, the camera immediately switches to capture status, so the time that sound is recorded may be reduced.

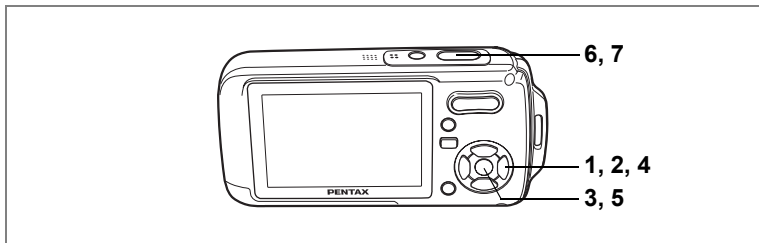

Taking Pictures of Text (Text Mode)

You can take pictures of text in documents or on a whiteboard so that the text is easy to read. Choose from four text modes.

	Color	A picture of the text is taken in its original color.
	Reversed Color	A picture of text is taken with the colors reversed.
	Black and White	A picture of the text is taken in black and white.
	Negative	A picture of text is taken with the black and white portions reversed.

- 1 Press the four-way controller (▼) in mode.**
The Capture Mode Palette appears.
- 2 Use the four-way controller (▲▼◀▶) to select (Text).**
- 3 Press the OK button.**
The text mode selection screen appears.
- 4 Use the four-way controller (▲▼) to select .**
- 5 Press the OK button.**
The text mode setting is saved and the camera returns to capture status.
- 6 Press the shutter release button halfway.**
The focus frame on the LCD monitor turns green if the subject is in focus.
- 7 Press the shutter release button fully.**
The picture is taken.



In mode, AE metering is set to multi-segment metering.

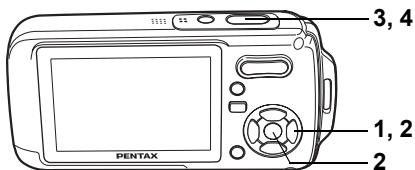

Using the Self-timer

In Self-timer mode, the picture is taken ten seconds or two seconds after the shutter release button is pressed.

Stabilize the camera with a tripod when taking a picture with the self-timer.

	<p>Use this mode when you want to be included in a group picture. The picture is taken approximately ten seconds after the shutter release button is pressed.</p>
	<p>Use this mode to avoid camera shake. The picture is taken approximately two seconds after the shutter release button is pressed.</p>

1 Press the four-way controller (▲) in mode.

2 Use the four-way controller (◀▶▼) to select or and press the OK button.

The camera is ready to take the picture using the self-timer.

3 Press the shutter release button halfway.

The focus frame on the LCD monitor turns green if the subject is in focus.

4 Press the shutter release button fully.

The picture is taken ten seconds or two seconds later.



Focusing may be compromised if you move the camera while the self-timer lamp is blinking when taking still pictures.



- In mode, recording will start after ten seconds (or two seconds).
- Press the shutter release button halfway while the self-timer is engaged to stop the countdown and press fully to restart the countdown.
- cannot be selected while is in default setting. Select in another shooting mode and then switch the shooting mode to .

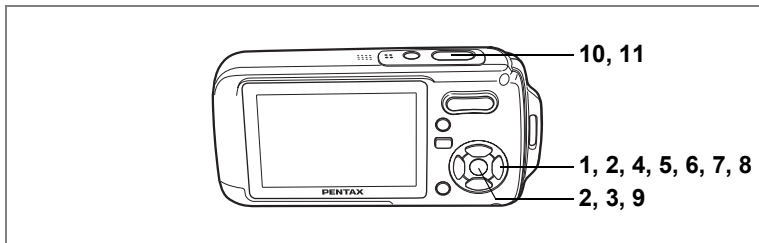

Taking Pictures at a Set Interval (Interval Shoot)

In this mode, a set number of pictures can be taken automatically at a set interval from a set time.

4

Taking Pictures

Interval	10 sec. – 99 min.	Set the camera to take pictures at one second intervals from ten seconds to four minutes or at one minute intervals from four minutes to 99 minutes. You cannot set the camera to take interval shots for less than ten seconds.
Number of Shot	2 shots – number of recordable images	You can set this to up to 1000 shots. However, this cannot exceed the number of recordable images.
Start Time	In 0 min. – 24 hours, 0 min.	Set the start time in one minute intervals for when the camera is to begin interval shooting. If the start time is set to 0 min., the first picture is taken as soon as the shutter release button is pressed.

1 Press the four-way controller (▲) in mode.

2 Use the four-way controller (◀▶) to select (Interval Shoot) and press the OK button.

The current interval shoot setting appears for approximately five seconds. To take pictures with the current setting, go to Step 8.



3 Press the OK button while the setting is displayed.

The Interval Shoot setting screen appears. [Interval] is marked with a frame.

4 Set the interval.

- 1 Press the four-way controller (▶).
- 2 Use the four-way controller (▲▼) to set the minute, then press the four-way controller (▶).
- 3 Use the four-way controller (▲▼) to set the seconds, then press the four-way controller (▶).

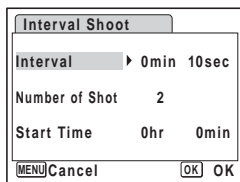

The frame returns to [Interval].

5 Press the four-way controller (▼).

The frame moves to [Number of Shot].

6 Set the number of shots.

- 1 Press the four-way controller (▶).
- 2 Use the four-way controller (▲▼) to set [Number of Shot], then press the four-way controller (▶).

The frame returns to [Number of Shot].

7 Press the four-way controller (▼).

The frame moves to [Start Time].

8 Set the start time.

- 1 Press the four-way controller (▶).
- 2 Use the four-way controller (▲▼) to set the hour, then press the four-way controller (▶).
- 3 Use the four-way controller (▲▼) to set the minute, then press the four-way controller (▶).

The frame returns to [Start Time].

9 Press the OK button.

The Interval Shoot setting is saved and the camera returns to capture status.

10 Press the shutter release button halfway.

The focus frame on the LCD monitor turns green if the subject is in focus.







11 Press the shutter release button fully.

Interval shooting starts.

The camera turns off between shots (during standby). Press the power switch during standby to display the remaining number of pictures and interval on the LCD monitor.

To cancel interval shooting, press the **MENU** button to display the message [Stop interval shooting] and then press the **OK** button.



Interval shooting is not available in , , , , , or  mode.

Setting the Digital Zoom

The digital zoom is set to (On) in the default settings. To take pictures using only the optical zoom, set the digital zoom to (Off).

1 Press the MENU button in  mode.

The [ Rec.Mode] menu appears.

2 Use the four-way controller (▲▼) to select [Digital Zoom].

3 Use the four-way controller (◀▶) to select (On) or (Off).

The selected setting is saved.

4 Press the MENU button halfway.

The setting is complete and the camera returns to capture status.

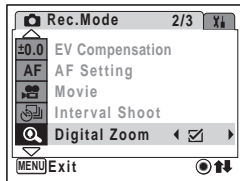

Saving the Digital Zoom Function Setting  p.103



The digital zoom function cannot be used in ,  or  mode.

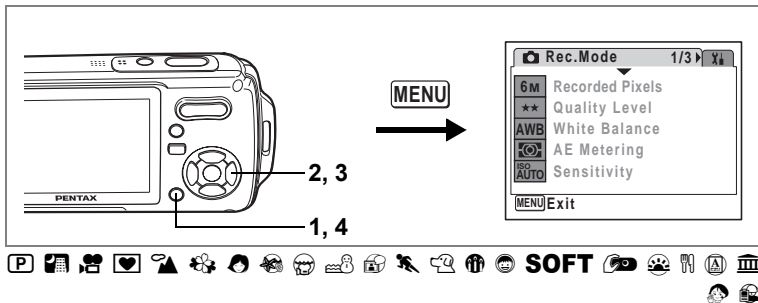

Setting the Exposure (EV Compensation)

4

Taking Pictures

You can adjust the overall brightness of the picture.

Use this function to take pictures that are intentionally overexposed or underexposed.

1 Press the **MENU** button in mode.

The [Rec.Mode] menu appears.

2 Use the four-way controller () to select [**EV Compensation**].

3 Use the four-way controller () to select the **EV** value.

The selected EV value is saved.

To brighten, select a positive (+) value. To darken, select a negative (-) value.

You can choose the EV setting in the range of -2.0 EV to +2.0 EV in 1/3 EV steps.

4 Press the **MENU** button.

The setting is complete and the camera returns to capture status.

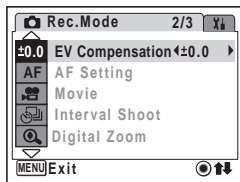

- If you use the EV compensation function frequently, you can save time by assigning it to the Green button. (p.58)
- When the histogram is displayed, bright portions and dark portions are indicated on the LCD monitor, enabling you to check the exposure. (p.84)
- The EV compensation function cannot be used in or mode.

Saving the EV Compensation Value p.103

Displaying Shooting Information in Capture Mode

The LCD monitor display changes in the following sequence each time you press the **OK/DISPLAY** button: Normal Display, Histogram + Info, No Icons, Backlight Off.

For details of each display mode, refer to “Monitor Indications” (p.18).



- All the camera buttons function as normal even when the backlight is off. Press the shutter release button to take pictures as normal.
- appears when camera shake is likely to occur. To prevent camera shake, use a tripod and the self-timer function. (p.76)
- In , , or mode, only , , or and the focus frame appear on the LCD monitor. No other shooting information is displayed. In addition, you cannot change the information displayed on the LCD monitor by pressing the **OK/DISPLAY** button.

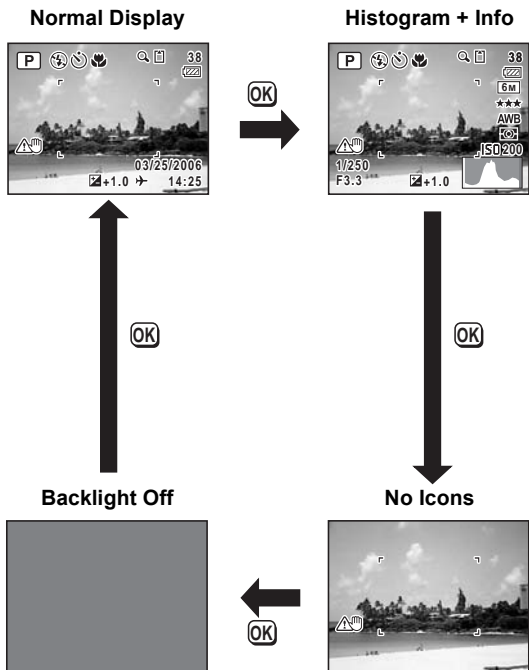

Using the Histogram

A histogram shows the brightness distribution of an image. The horizontal axis represents brightness (dark at the left and bright at the right) and the vertical axis represents the number of pixels.

The shape of the histogram before and after shooting tells you whether the brightness and contrast are correct or not, and lets you decide if you need to use EV compensation and take the picture again.

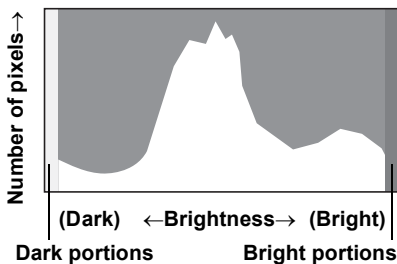

Setting the Exposure (EV Compensation) p.82

Understanding Brightness

If the brightness is correct, the graph peaks in the middle. If the image is too dark, the peak is on the left side, and if it is too bright, the peak is on the right side.

Dark image

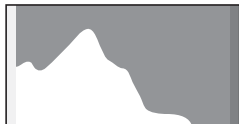

Correct image

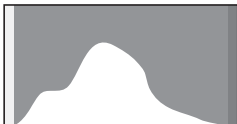

Bright image

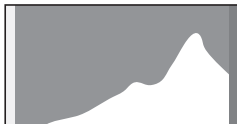

When the image is too dark, the part to the left is cut off (dark portions) and when the image is too bright, the part to the right is cut off (bright portions).

Bright portions blink red on the LCD monitor and dark portions blink yellow.

Displaying Shooting Information in Capture Mode p.83

Displaying Shooting Information in Playback Mode p.118

Understanding Contrast

The graph peaks gradually for images in which contrast is balanced. The graph peaks on both sides but sinks in the middle for images with a large difference in contrast and low amounts of mid-level brightness.

Setting the Shooting Functions

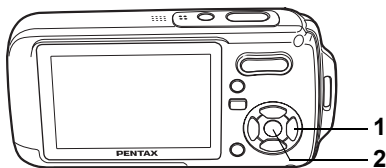

Selecting the Focus Mode

Focus Mode

AF	Standard	Use this mode when the distance to the subject is 40 cm (16 in.) or more. The camera is focused on the subject in the autofocus area when the shutter release button is pressed halfway.
	Macro	This mode is used when the distance to the subject is approx. 1 cm to 60 cm (0.4 in. to 24 in.). The camera is focused on the subject in the autofocus area when the shutter release button is pressed halfway.
	Infinity	This mode is used for taking distant objects. The flash is set to (Flash Off).
PF	Pan Focus	This mode is used when you ask someone to take pictures for you, or when taking pictures of the scenery through the window of a car or train. The entire picture, from the front to the back, is focused sharply.
MF	Manual Focus	This mode lets you adjust the focus manually.

1 Press the four-way controller (▶) in mode.

The focus mode changes each time the button is pressed. You can also change the setting using the four-way controller (▲▼).

2 Press the OK button.

The Focus Mode setting is saved and the camera returns to capture status.

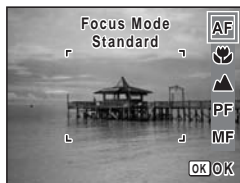



- In mode, the focus mode is set to .
- In mode, you can only select **AF** and .

Saving the Focus Mode p.103

Manual Focus

The procedure for setting the focus manually (**MF**) is described below.

- 1 Press the four-way controller (▶) in mode.**
- 2 Use the four-way controller (▶) to select MF and press the OK button.**

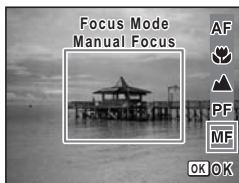

The central portion of the image is magnified to fill the screen of the LCD monitor when focusing.

- 3 Press the four-way controller (▲▼).**

The **MF** indicator appears on the LCD monitor to indicate the approximate distance to the subject. Use the four-way controller (▲▼) to adjust the focus using the indicator as a guide.

- ▲ : for distant focus
- ▼ : for closer focus

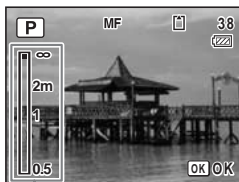

MF indicator

- 4 Press the OK button.**

The focus is fixed and the camera returns to capture status. In addition, the focus position is fixed five seconds after you remove your finger from the four-way controller (▶). After the focus is fixed, you can press the four-way controller (▶) again to display the **MF** bar and readjust the focus.



To switch from **MF** to another focus mode, press the four-way controller (▶) while the **MF** bar is displayed.



Capture mode and drive mode cannot be changed while the **MF** bar is displayed.

1 Press the four-way controller (◀) in mode.



The flash mode changes each time the button is pressed. You can also change the setting using the four-way controller (▲▼).

2 Press the OK button.

The camera returns to capture status with the selected flash mode.



[About the red-eye phenomenon]

Taking pictures using the flash may cause the subject's eyes to appear red in the resulting picture. This phenomenon occurs when the light from the flash is reflected in the subject's eyes. It can be reduced by illuminating the area around the subject or moving closer to the subject and zooming out to a wider angle. Setting the flash mode to  (Auto + Red-eye) or  (Flash On + Red-eye) is also an effective way of reducing red eyes.

If the subject's eyes appear red despite such precautions, they can be corrected by the red-eye compensation function (p.138).

Saving the Flash Mode  p.103

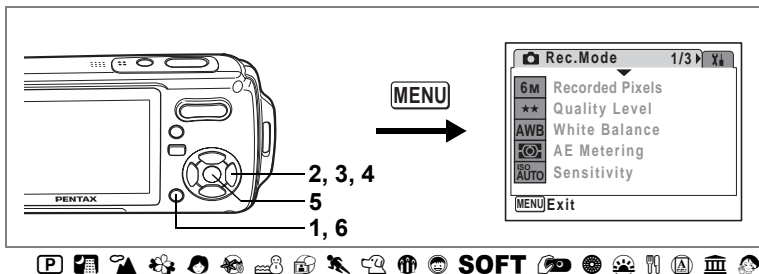

Selecting the Recorded Pixels

You can choose from seven recorded pixels settings for still pictures. The larger your recorded pixels, the clearer the details will appear when you print your picture. As the quality of the printed picture also depends on the image quality, exposure control, resolution of the printer and other factors, you do not need to select more than the required number of recorded pixels. **2M** (1600×1200) is adequate for making postcard-size prints. The more pixels there are, the larger the picture and the bigger the file size. The data volume also varies depending on the quality level setting (p.91).

Recorded Pixels

Recorded Pixels	Use
6M 2816×2112	For printing high quality photos or A4-size pictures, or editing images on a PC.
5M 2560×1920	
4M 2304×1728	For making postcard-size prints.
3M 2048×1536	
2M 1600×1200	
1024 1024× 768	For posting on a website or attaching to e-mail.
640 640× 480	

- 1 Press the MENU button in mode.**
The [Rec.Mode] menu appears.
- 2 Use the four-way controller () to select [Recorded Pixels].**

3 Press the four-way controller (▶).

A pull-down menu appears.

4 Use the four-way controller (▲▼) to change the number of recorded pixels.

5 Press the OK button.

The Recorded Pixels setting is saved.

6 Press the MENU button.

The camera returns to capture status with the current setting.

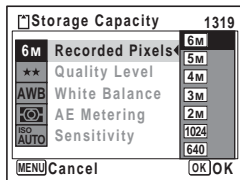

- When shooting mode is set to , the number of recorded pixels is set to **3M** and quality level is set to **★★**.
- When drive mode is set to the number of recorded pixels is set to **3M**, and when Capture mode is set to , the number of recorded pixels is set to **1280** (1280×960).
- If you use the [Recorded Pixels] function frequently, you can save time by assigning it to the Green button. (p.58)

Recorded Pixels and Quality Level of Still Pictures p.31

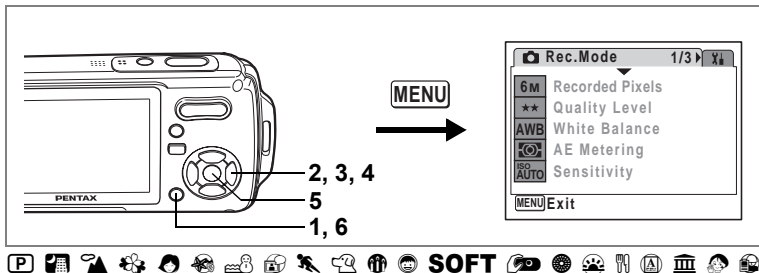

Selecting the Quality Level

You can select the quality (compression rate) of still pictures. The more stars, the lower the compression rate and the clearer the picture, but the file size becomes larger. The recorded pixels setting also affects the file size (p.89).

Quality Level

★★★	Best	Lowest compression rate. Suitable for photo prints.
★★	Better	Standard compression rate. Suitable for viewing the image on a computer screen.
★	Good	Highest compression rate. Suitable for posting on a website or attaching to e-mail.

- 1 Press the MENU button in mode.**
The [Rec.Mode] menu appears.
- 2 Use the four-way controller (▲▼) to select [Quality Level].**
- 3 Press the four-way controller (▶).**
A pull-down menu appears.
- 4 Use the four-way controller (▲▼) to change the quality level.**
- 5 Press the OK button.**
The Quality Level setting is saved.
- 6 Press the MENU button.**
The camera returns to capture status with the current setting.

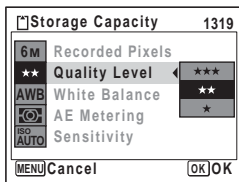

- If you use the [Quality Level] function frequently, you can save time by assigning it to the Green button. (p.58)
- Quality level is set at ★★ when shooting mode is set to .

Recorded Pixels and Quality Level of Still Pictures p.31

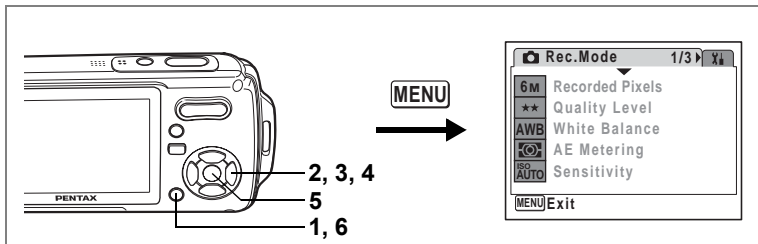

Adjusting the White Balance

You can take pictures in natural colors by adjusting the white balance according to the light conditions at the time of shooting.

4

White Balance

AWB	Auto	The camera adjusts the white balance automatically.
	Daylight	Use this mode when taking pictures outside in sunlight.
	Shade	Use this mode when taking pictures outside in the shade.
	Tungsten Light	Use this mode when taking pictures under electric or other tungsten light.
	Fluores. Light	Use this mode when taking pictures under fluorescent light.
	Manual	Use this mode when adjusting the white balance manually.

- 1 Press the MENU button in mode.**
The [Rec.Mode] menu appears.
- 2 Use the four-way controller () to select [White Balance].**
- 3 Press the four-way controller ().**
The White Balance screen appears.
- 4 Use the four-way controller () to change the setting.**

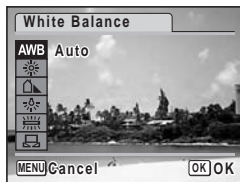

5 Press the OK button.

The White Balance setting is saved.

6 Press the MENU button.

The camera returns to capture status with the current setting. Refer to “Manual Setting” below for instructions on adjusting the white balance manually.



If you use the [White Balance] function frequently, you can save time by assigning it to the Green button. (p.58)

Saving the White Balance p.103

Manual Setting

Have a blank sheet of white paper or similar material ready.

1 In the White balance screen, use the four-way controller (▲▼) to select (Manual).

2 Point the camera at the blank sheet of paper or other material so that it fills the frame displayed in the center of the screen.

3 Press the shutter release button fully.

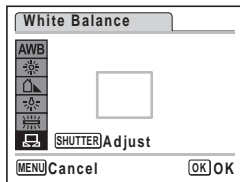

The white balance is automatically adjusted.

4 Press the OK button.

The setting is saved and the screen returns to the [Rec.Mode].

5 Press the MENU button.

The camera returns to capture status.

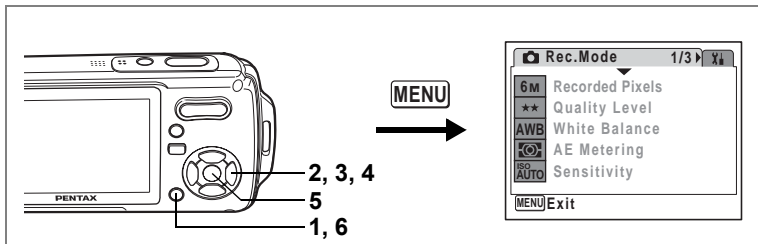

Setting the AE Metering

You can set the area of the screen where the brightness is metered to determine the exposure.

4

AE metering

	Multi-segment metering	The camera divides the image into 16 areas, meters the brightness and determines the exposure.
	Center-weighted metering	The camera takes a uniform reading of the overall brightness of the picture with the metering focused at the center of the image.
	Spot AE metering	The camera determines the exposure by metering the brightness only at the center of the image.

1 Press the **MENU** button in mode.

The [Rec.Mode] menu appears.

2 Use the four-way controller () to select [**AE Metering**].

3 Press the four-way controller ().

A pull-down menu appears.

4 Use the four-way controller () to select the **AE Metering** setting.

5 Press the **OK** button.

The AE Metering setting is saved.

6 Press the **MENU** button.

The camera returns to capture status with the current setting.

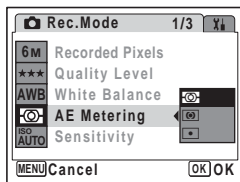



- When the shutter release button is pressed halfway, the brightness is metered and the exposure is determined.
- When the subject is outside the focusing area and you want to use spot AE metering, aim the camera at the subject and press the shutter release button halfway to lock the exposure, then compose your picture again and press the shutter release button fully.
- If you use the [AE Metering] function frequently, you can save time by assigning it to the Green button. (p.58)
- In , , , , , , , , **SOFT** , , , , , , , or mode, AE metering is set to multi-segment metering.

Saving the AE Metering p.103

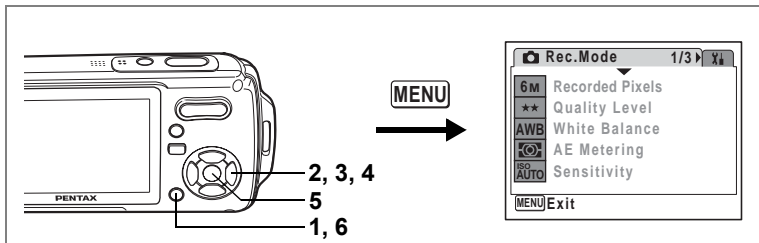

Setting the Sensitivity

You can select the sensitivity to suit the brightness of the surroundings.

4

Sensitivity

Auto	Sensitivity is automatically adjusted to between 64 and 400.
64	<ul style="list-style-type: none"> The lower the sensitivity, the less noise that affects the image. The shutter speed will be slower in low light conditions. Higher sensitivity settings use faster shutter speeds in low light conditions to reduce camera shake, but the image may be affected by noise.
100	
200	
400	
800	

- 1 Press the MENU button in mode.**
The [Rec.Mode] menu appears.
- 2 Use the four-way controller () to select [Sensitivity].**
- 3 Press the four-way controller ().**
A pull-down menu appears.
- 4 Use the four-way controller () to change the sensitivity.**
- 5 Press the OK button.**
The Sensitivity setting is saved.
- 6 Press the MENU button.**

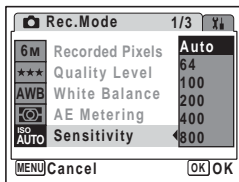

The camera returns to capture status with the current setting.



- When set to [Auto] with the shooting mode set to or , the sensitivity is automatically adjusted to between 64 and 800.
- Sensitivity is set at 64 when shooting mode is set to . Other values cannot be set.
- If you use the [Sensitivity] function frequently, you can save time by assigning it to the Green button. (p.58)

Saving the Sensitivity p.103

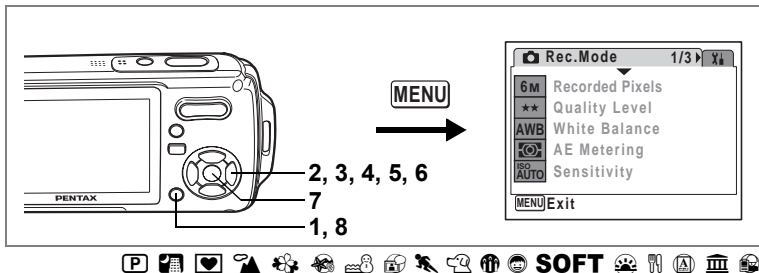

Setting the Autofocus Conditions

You can set various conditions for autofocus.

Setting the Focusing Area

You can change the autofocus area (Focusing Area).

Focusing Area

[]	Multiple	Normal range
[]	Spot	The autofocus range becomes smaller.
[]	Automatic Tracking AF	Keeps moving subjects in focus.

- 1 Press the MENU button in mode.**
The [Rec.Mode] menu appears.
- 2 Use the four-way controller (▲▼) to select [AF Setting].**
- 3 Press the four-way controller (▶).**
The AF Setting screen appears.
- 4 Use the four-way controller (▲▼) to select [Focusing Area].**
- 5 Press the four-way controller (▶).**
A pull-down menu appears.
- 6 Use the four-way controller (▲▼) to change the AF setting.**

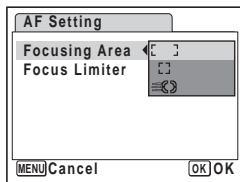

7 Press the **OK** button.

The AF Setting is saved.

8 Press the **MENU** button twice.

The camera returns to capture status with the current setting.



- In , and mode, [Focusing Area] can only be set to (Multiple) or (Spot).
- In , and mode, [Focusing Area] is set to (Multiple).
- If you use the [Focusing Area] function frequently, you can save time by assigning it to the Green button. (p.58)

Setting the Focus Limiter

You can limit the lens movement range according to the conditions. Set the [Focus Limiter] to (On) to limit the focus to far distances from normal range during normal shooting and to close distances during macro shooting. This enables faster focusing.

1 Press the **MENU** button in mode.

The [Rec.Mode] menu appears.

2 Use the four-way controller () to select [AF Setting].

3 Press the four-way controller ().

The AF Setting screen appears.

4 Use the four-way controller () to select [Focus Limiter].

5 Use the four-way controller () to select (On) or (Off).

The Focus Limiter setting is saved.

6 Press the **MENU** button twice.

The camera returns to capture status with the current setting.

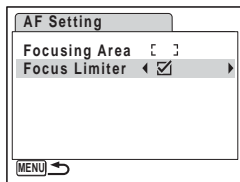

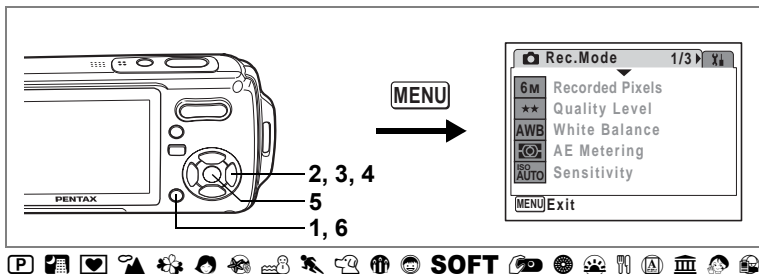

Setting the Instant Review Time (Instant Review)

You can choose the Instant Review time (the length of time the image is displayed immediately after capture) from 0.5sec, 1sec, 2sec, 3sec, 5sec and Off (no display).

1 Press the **MENU** button in **📷** mode.

The [📷 Rec.Mode] menu appears.

2 Use the four-way controller (▲▼) to select [Instant Review].

3 Press the four-way controller (▶).

A pull-down menu appears.

4 Use the four-way controller (▲▼) to change the display time.

5 Press the **OK** button.

The Instant Review setting is saved.

6 Press the **MENU** button.

The camera returns to capture status with the current setting.

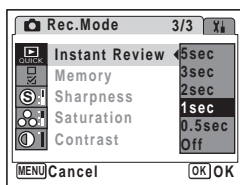

Instant Review p.41

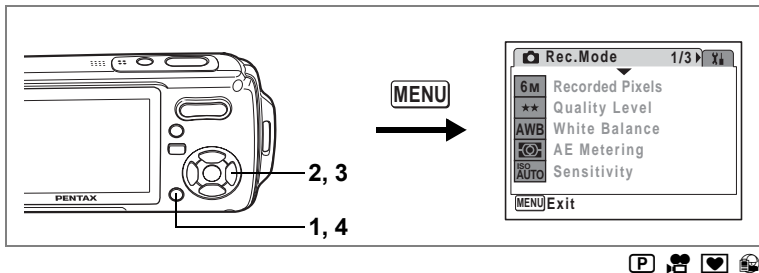

Setting the Image Sharpness (Sharpness)

You can give the image sharp or soft outlines.

- 1 Press the MENU button in mode.**
The [Rec.Mode] menu appears.
- 2 Use the four-way controller () to select [Sharpness].**
- 3 Use the four-way controller () to change the sharpness level.**

The following setting is saved.

- (Soft)
- (Normal)
- (Hard)

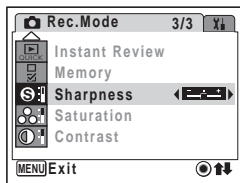

- 4 Press the MENU button.**

The Sharpness setting is saved and the camera returns to capture status.



If you use the [Sharpness] function frequently, you can save time by assigning it to the Green button. (p.58)

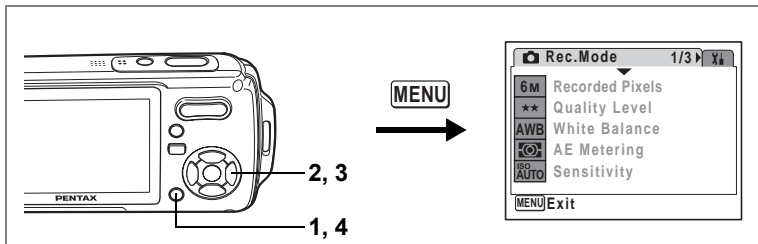

Setting the Color Saturation (Saturation)

You can set the color saturation.

- 1 Press the MENU button in mode.**
The [Rec.Mode] menu appears.
- 2 Use the four-way controller () to select [Saturation].**
- 3 Use the four-way controller () to change the saturation level.**

The following setting is saved.

- (Low)
- (Normal)
- (High)

- 4 Press the MENU button.**

The Saturation setting is saved and the camera returns to capture status.

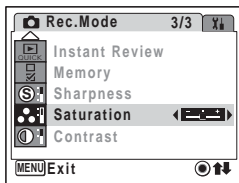

If you use the [Saturation] function frequently, you can save time by assigning it to the Green button. (p.58)

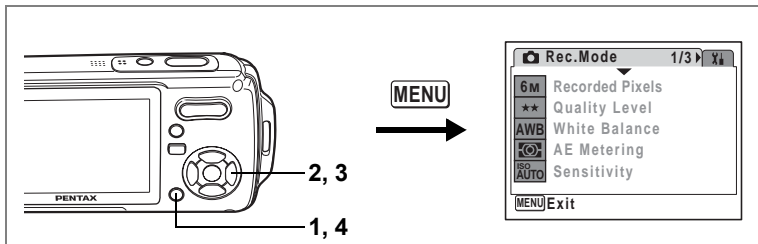

Setting the Image Contrast (Contrast)

You can set the image contrast level.

4

1 Press the MENU button in mode.

The [Rec.Mode] menu appears.

2 Use the four-way controller () to select [Contrast].

3 Use the four-way controller () to change the contrast level.

The following setting is saved.

(Low)

(Normal)

(High)

4 Press the MENU button.

The Contrast setting is saved and the camera returns to capture status.

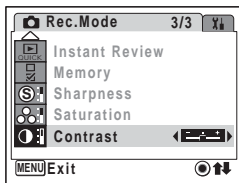

If you use the [Contrast] function frequently, you can save time by assigning it to the Green button. (p.58)







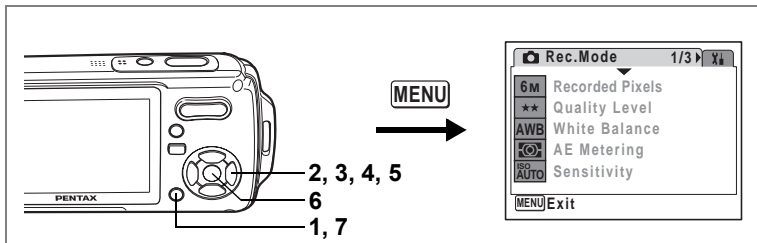

Saving the Settings (Memory)

The Memory function is for saving the current camera settings when the camera is turned off.

For some camera settings, the Memory function is always set to (On) (the settings are saved when the camera is turned off), while for others you can choose on or off (to choose whether the settings are saved or not when the camera is turned off). The items which can be set to (On) or (Off) in the Memory function are shown in the table below. (Items not listed here will be saved in the selected settings when the camera is turned off.) If you select (On), the settings will be saved in the status they were in immediately before the camera was turned off. If you select (Off), the settings will be reset to the defaults when the camera is turned off. The table below also shows whether the Memory default setting for each item is on or off.

Item	Description	Default Setting
Flash Mode	The flash mode set with the four-way controller (◀) (p.87)	<input checked="" type="checkbox"/>
Drive Mode	The drive mode set with the four-way controller (▲) (p.76, p.77, p.78)	<input type="checkbox"/>
Focus Mode	The focus mode set with the four-way controller (▶) (p.85)	<input type="checkbox"/>
Zoom Position	The zoom position set with the Zoom/⬆️/⬇️ button (p.80)	<input type="checkbox"/>
MF Position	The manual focus position set with the four-way controller (▲▼) (p.86)	<input type="checkbox"/>
White Balance	The [White Balance] setting on the [📷 Rec.Mode] menu (p.92)	<input type="checkbox"/>
Sensitivity	The [Sensitivity] setting on the [📷 Rec.Mode] menu (p.96)	<input type="checkbox"/>
EV Compensation	The [EV Compensation] setting on the [📷 Rec.Mode] menu (p.82)	<input type="checkbox"/>
AE Metering	The [AE Metering] setting on the [📷 Rec.Mode] menu (p.94)	<input type="checkbox"/>
Digital Zoom	The [Digital Zoom] setting on the [📷 Rec.Mode] menu (p.81)	<input checked="" type="checkbox"/>
DISPLAY	The LCD monitor information display mode set with the OK/DISPLAY button (p.83, p.118)	<input type="checkbox"/>
File #	If a new SD Memory Card is inserted when On has been selected, file numbers are assigned sequentially.	<input checked="" type="checkbox"/>



- 1 **Press the MENU button in  mode.**
The [ Rec.Mode] menu appears.
- 2 **Press the four-way controller ( ) to select [Memory].**
- 3 **Press the four-way controller () .**
The Memory screen appears.
- 4 **Use the four-way controller ( ) to choose an item.**
- 5 **Use the four-way controller ( ) to select (On) or (Off).**
- 6 **Press the OK button.**
The Memory setting is saved.
- 7 **Press the MENU button.**
The camera returns to capture status with the current setting.

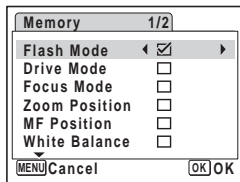

Recording Movies

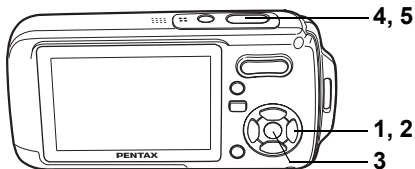

Recording a Movie

This mode enables you to record movies. Sound is recorded at the same time.

1 Press the four-way controller (▼) in mode.

The Capture Mode Palette appears.

2 Use the four-way controller (▲▼◀▶) to select (Movie).



3 Press the OK button.

mode is selected and the camera returns to capture status.

The following information appears on the LCD monitor.

- 1 Movie mode icon
- 2 Recording indicator (blinks during recording)
- 3 Recording time
- 4 Movie anti-shake function icon
- 5 Still picture capture icon (p.106)

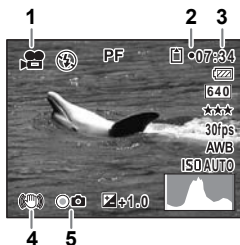

You can change the captured area by pressing the Zoom//▲ button to the left or right.

▲ : enlarges the subject

▲▲▲ : widens the area that is captured by the camera

4 Press the shutter release button fully.

Recording starts.



- The flash will not discharge in mode.
- In mode, the default setting for focus mode is **PF**. (p.85)
The focus mode can be changed before recording starts.
- When the Focus Mode is set to **MF**, you can adjust the focus before recording starts and during recording.
- You can use the optical zoom and digital zoom before recording starts and during recording.
- Changing the LCD monitor display mode by pressing the **OK/DISPLAY** button while recording a movie will not display the histogram.

4

Setting the Optical Zoom p.112

5 Press the shutter release button fully.

Recording stops.

Playing Back Movies p.121

Keeping the Shutter Release Button Pressed

If you keep the shutter release button pressed for more than one second, recording will continue for as long as you keep the button pressed. Shooting stops when you take your finger off the shutter release button.

Taking Still Pictures During Movie Recording (Still picture capture)

Press the Green button during movie recording to take still pictures while continuing to record the movie. After the Green button is pressed, a still picture is taken and stored.



When the battery level indicator is at (battery is exhausted), the flash will not discharge when taking still pictures during movie recording.

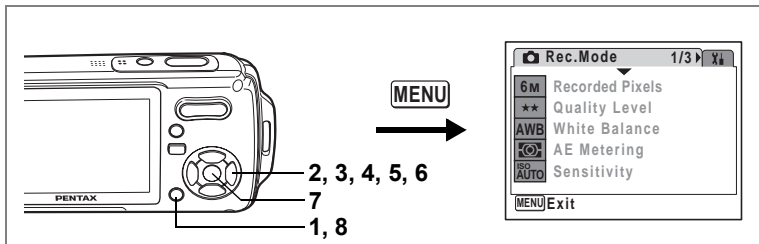

Selecting the Recorded Pixels for Movies

You can choose from two recorded pixels settings for movies: **640** and **320**.

The more pixels there are, the clearer the details and the bigger the file size. The data volume also varies depending on the quality level and frame rate settings. (p.32)

Recorded Pixels for Movies

640 (640×480)	Suitable for viewing on a TV or computer screen.
320 (320×240)	Suitable for posting on a website or attaching to e-mail.

- 1 Press the MENU button in mode.**
The [Rec.Mode] menu appears.
- 2 Use the four-way controller (▲▼) to select [Movie].**
- 3 Press the four-way controller (▶).**
The Movie screen appears.
- 4 Use the four-way controller (▲▼) to select [Recorded Pixels].**
- 5 Press the four-way controller (▶).**
A pull-down menu appears.
- 6 Use the four-way controller (▲▼) to change the number of recorded pixels.**
- 7 Press the OK button.**
The Recorded Pixels setting is saved.
- 8 Press the MENU button twice.**
The camera returns to capture status with the current setting.

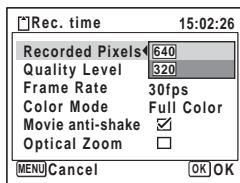

Recorded Pixels, Quality Level and Frame Rate of Movies p.32

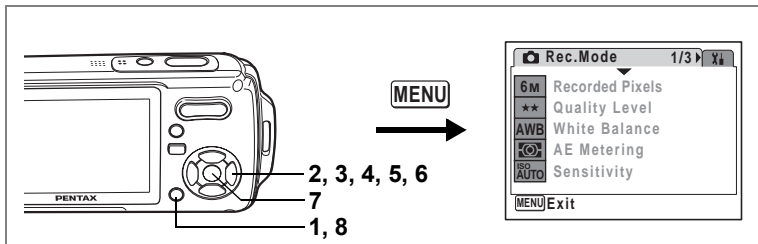

Selecting the Quality Level of Movies

You can set the quality level of movies. The higher the quality level, the clearer the details and the bigger the file size.

4

Quality level of movies

★★★	Best	↑ ↓	Clearer images
★★	Better		Grainier images
★	Good		

- 1 Press the MENU button in mode.**
The [Rec.Mode] menu appears.
- 2 Use the four-way controller (▲▼) to select [Movie].**
- 3 Press the four-way controller (▶).**
The Movie screen appears.
- 4 Use the four-way controller (▲▼) to select [Quality Level].**
- 5 Press the four-way controller (▶).**
A pull-down menu appears.
- 6 Use the four-way controller (▲▼) to change the quality level.**
- 7 Press the OK button.**
The Quality Level setting is saved.
- 8 Press the MENU button twice.**
The camera returns to capture status with the current setting.

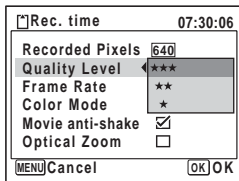

Recorded Pixels, Quality Level and Frame Rate of Movies p.32

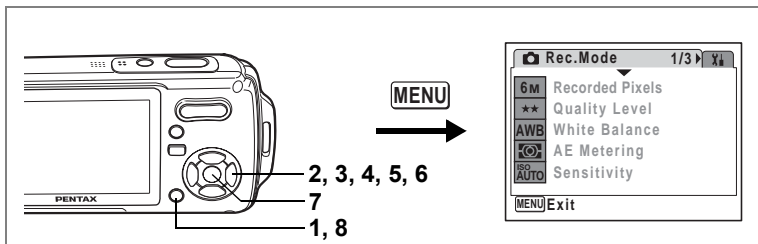

Selecting the Frame Rate

You can choose from two frame rates (number of frames per second) for movies: 30fps (frames per second) and 15fps. The more frames per second, the better the quality of the movie, but the file size becomes larger.

- 1 Press the MENU button in mode.**
The [Rec.Mode] menu appears.
- 2 Use the four-way controller () to select [Movie].**
- 3 Press the four-way controller ().**
The Movie screen appears.
- 4 Use the four-way controller () to select [Frame Rate].**
- 5 Press the four-way controller ().**
A pull-down menu appears.
- 6 Use the four-way controller () to select [30fps] or [15fps].**
- 7 Press the OK button.**
The Frame Rate setting is saved.
- 8 Press the MENU button twice.**
The camera returns to capture status with the current setting.

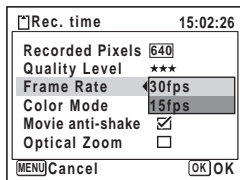

Recorded Pixels, Quality Level and Frame Rate of Movies p.32

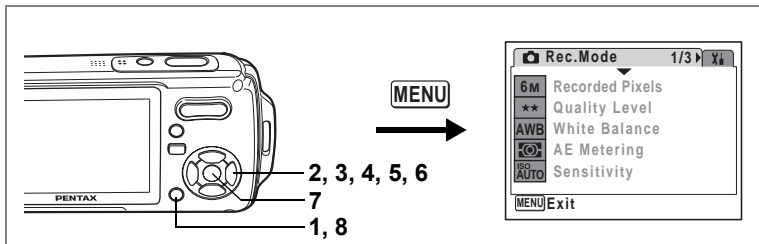

Recording Movies in Black and White or Sepia Tones (Color Mode)

4

You can set the color mode to black and white or sepia, as well as full color, when recording a movie.

1 Press the **MENU** button in mode.

The [Rec.Mode] menu appears.

2 Use the four-way controller () to select [Movie].

3 Press the four-way controller ().

The Movie screen appears.

4 Use the four-way controller () to select [Color Mode].

5 Press the four-way controller ().

A pull-down menu appears.

6 Use the four-way controller () to choose a color.

7 Press the **OK** button.

The Color Mode setting is saved.

8 Press the **MENU** button twice.

The camera returns to capture status with the current setting.

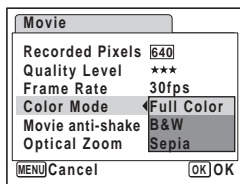

The color mode setting cannot be changed after a movie is recorded.

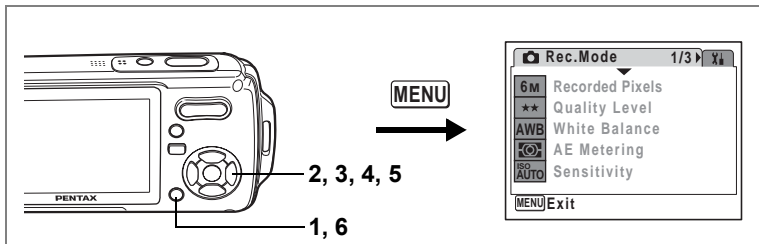

Setting the Movie Anti-Shake Function

In and mode, you can use the Movie anti-shake function to prevent camera shake.

- 1 Press the MENU button in mode.**
The [Rec.Mode] menu appears.
- 2 Use the four-way controller (▲▼) to select [Movie].**
- 3 Press the four-way controller (▶).**
The Movie screen appears.
- 4 Use the four-way controller (▲▼) to select [Movie anti-shake].**
- 5 Use the four-way controller (◀▶) to select (On) or (Off).**
The Movie anti-shake setting is saved.
- 6 Press the MENU button twice.**
The camera returns to capture status with the current setting.

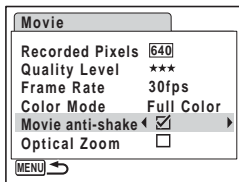

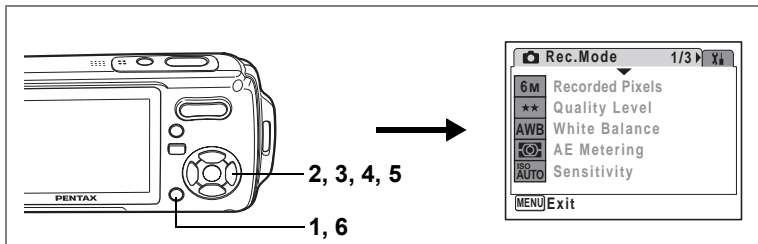

Setting the Optical Zoom

You can set whether or not to use the optical zoom during movie recording.

4

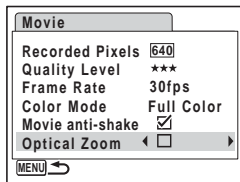

Taking Pictures

- 1 Press the MENU button in mode.**
The [Rec.Mode] menu appears.
- 2 Use the four-way controller (▲▼) to select [Movie].**
- 3 Press the four-way controller (▶).**
The Movie screen appears.
- 4 Use the four-way controller (▲▼) to select [Optical Zoom].**
- 5 Use the four-way controller (◀▶) to select (On) or (Off).**
The Optical Zoom setting is saved.
- 6 Press the MENU button twice.**
The camera returns to capture status with the current setting.



Playing Back Images

To Switch Between Mode and Mode

In this manual, the capture mode, such as for taking still pictures, is referred to as [ mode]. The playback mode, such as for displaying captured images on the LCD monitor, is referred to as [ mode]. In [ mode], you can perform simple editing operations on the images that are played back.

Follow the procedure below to switch between  mode and [ mode].

To Switch from Mode to [Mode

1 Press the [ button.

The camera switches to [ mode.

To Switch from [Mode to Mode



1 Press the [ button or shutter release button halfway.

The camera switches to  mode.

Playing Back Still Pictures

Refer to “Playing Back Images” (p.42) for instructions.

Switching to Folder Display or Calendar Display

In nine-image display, press  on the Zoom//Q button to switch to folder display or calendar display. Press the Green button to switch between folder display and calendar display.

1 In mode, press on the Zoom//Q button.





The screen changes to nine-image display.



2 Press on the Zoom//Q button.

The screen changes to folder display or calendar display.

Folder display

The list of folders with recorded images and sound files appears.

Use the four-way controller (   ) to move the frame.

Press the **OK** button or  on the Zoom//Q button to switch to nine-image display.

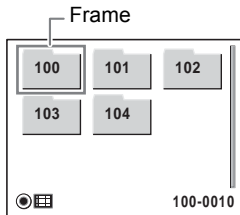







Calendar display

Recorded images and sound files are displayed by date in calendar format.

The first image recorded on a date is displayed for that date on the calendar.



 appears for dates on which a sound file was first recorded.

Use the four-way controller (   ) to move the frame.

Press  on the Zoom//Q button to display the images for a date in nine-image display.

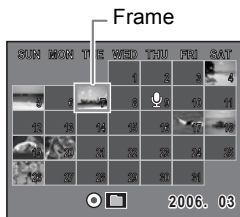
Select a date and press the **OK** button to switch to single-image display of the first image recorded on that date.



- Press the **MENU** button in folder display or calendar display to switch to normal nine-image display.
- Press the  button or half-press the shutter release button in folder display or calendar display to switch to  mode.

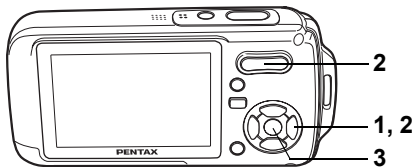

Zoom Playback

You can magnify an image up to eight times. A guide showing the center of the magnified portion of the image appears on the LCD monitor during zoom playback.

- 1 Enter the mode and use the four-way controller () to choose the image you want to magnify.**
- 2 Press on the Zoom// button.**

The image is magnified ($\times 1.1$ to $\times 8$). Holding down on the Zoom// button changes the magnification continuously. You can use the guide at the bottom left of the screen to check which portion of the image is magnified.



Guide

The following operations can be performed while the magnified image is displayed.

- | | |
|---------------------------|--|
| Four-way controller () | Moves the position to be magnified |
| Zoom// button () | Makes the image bigger (max. $\times 8$) |
| Zoom// button () | Makes the image smaller (min. $\times 1.1$) |

- 3 Press the OK button.**

The image returns to single-image display.



- Movies cannot be magnified.
- The guide does not appear if the LCD monitor display mode is set to “No Icons”.

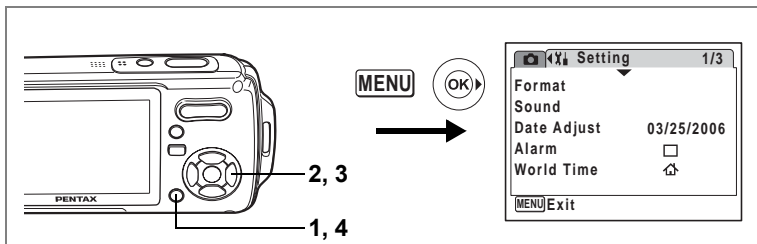

Setting the Quick Zoom Function

When the Quick Zoom function is enabled, you can display an image at maximum magnification ($\times 8$) simply by pressing \mathcal{Q} on the Zoom/ \mathcal{Q} button once.

1 Press the MENU button in \mathcal{P} mode.

The [X] Setting] menu appears.

2 Use the four-way controller (\blacktriangle \blacktriangledown) to select [Quick Zoom].

3 Use the four-way controller (\blacktriangleleft \blacktriangleright) to select (On) or (Off).

- : Jumps to $\times 8$ magnification
- : Pressing \mathcal{Q} on the Zoom/ \mathcal{Q} button once magnifies the image in stages from $\times 1.1$ to $\times 8.0$

4 Press the MENU button.

The camera returns to \mathcal{P} mode.

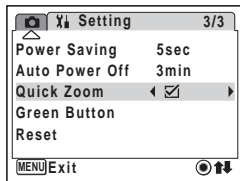

Displaying Shooting Information in Playback Mode

Shooting information can be displayed on the LCD monitor in  mode. Pressing the **OK/DISPLAY** button changes the display mode. Refer to p.20 for details of each display mode.

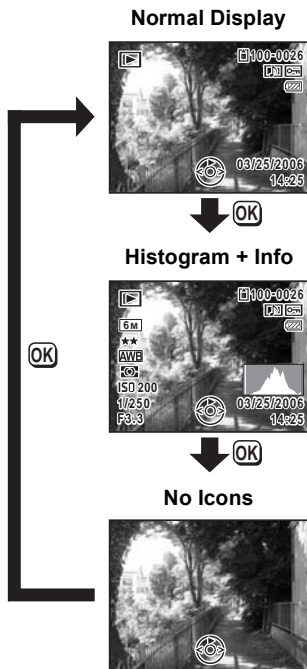



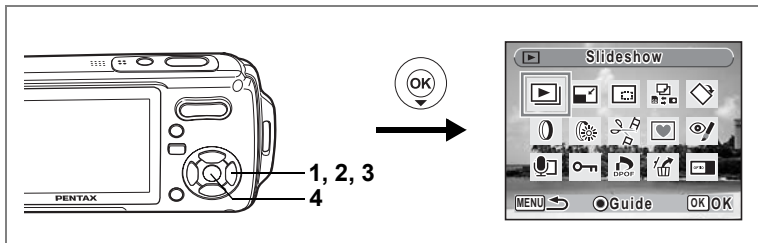





Displaying Shooting Information in Capture Mode  p.83









Slideshow

You can play back recorded images one after another.

- 1 Enter the  mode and use the four-way controller ( ) to choose an image to start the slideshow with.**
- 2 Press the four-way controller (.**
The Playback Mode Palette appears.
- 3 Use the four-way controller (   ) to select  (Slideshow).**
- 4 Press the OK button twice.**
The slideshow starts.
Pressing the **OK** button during the slideshow pauses the slideshow. To resume the slideshow, press the **OK** button while the slideshow is paused.
- 5 Press any button other than the OK button or the power switch.**
The slideshow stops.

Setting the Slideshow Conditions

You can set the playback interval and also a screen effect and sound effect for when one image changes to the next.

- 1 Press the four-way controller ( in  mode.**
The Playback Mode Palette appears.
- 2 Use the four-way controller (   ) to select  (Slideshow).**

3 Press the OK button.

The screen for setting the slideshow conditions appears.

4 Use the four-way controller (▲▼) to select [Interval].**5 Press the four-way controller (▶).**

A pull-down menu appears.

6 Use the four-way controller (▲▼) to change the interval and press the OK button.

You can choose from 3sec, 5sec, 10sec, 20sec, and 30sec.

7 Use the four-way controller (▲▼) to select [Screen Effect].

After selecting [Screen Effect], press the four-way controller (▶). A pull-down menu appears with the following items that can be selected. Use the four-way controller (▲▼) to select an item and press the **OK** button.

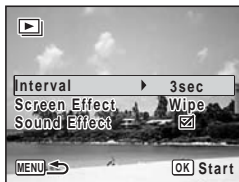

Off	No effect
Wipe	The next image slides over the previous one from left to right
Checker	The next image appears in small square mosaic blocks
Fade	The current image gradually fades out and the next image fades in

8 Use the four-way controller (▲▼) to select [Sound Effect].**9 Use the four-way controller (◀▶) to select (On) or (Off).**

Except when the screen effect is set to Off, you can choose (On) or (Off) for the sound that is played when one image changes to the next.

10 Press the OK button.

The slideshow starts using the selected interval and effect.



- The slideshow will continue until you press any button other than the **OK** button or the power switch.
- Movies or pictures with sound will normally be played through to the end before the next picture is played back, regardless of the interval setting. However, pressing the four-way controller (▶) while playing back a movie or a picture with sound skips to the next image.
- Sound files made in Voice Recording mode are not played back in the slideshow.

Connecting the Camera to AV Equipment p.122

Playing Back Movies

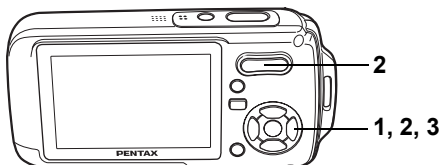

Playing Back a Movie

You can play back the movies you have taken. Sound is played back at the same time.

1 Enter the  mode and use the four-way controller (◀▶) to choose the movie you want to play back.

2 Press the four-way controller (▲).

Playback starts.



The following operations can be performed during playback.

- Four-way controller (◀) Reverse playback
- Four-way controller (▲) Pause
- Zoom/▲/▲/▲/▲ button (▲) Increases the volume
- Zoom/▲/▲/▲/▲ button (▲) Reduces the volume

The following operations can be performed while playback is paused.

- Four-way controller (◀) Frame reverse
- Four-way controller (▶) Frame forward
- Four-way controller (▲) Releases the Pause function (Play)

3 Press the four-way controller (▼).

Playback stops.

Connecting the Camera to AV Equipment

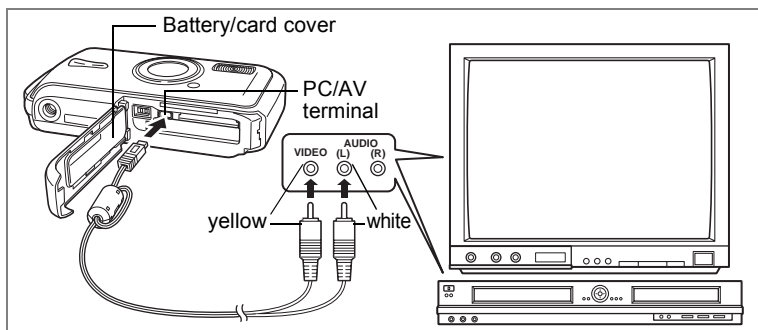

By using the AV cable, you can capture and play back images on equipment with a video IN jack, such as a TV. Make sure the camera and TV are turned off before connecting the camera to the TV.

5

Playing Back and Deleting Images

- 1 Open the battery/card cover and connect the AV cable to the PC/AV terminal.**
- 2 Connect the other ends of the AV cable (yellow: video, white: audio) to the AV device's video input terminal and audio input terminal.**

When using stereo sound equipment, insert the sound terminal into the L (white) terminal.

- 3 Turn the AV device on.**

When the device that the camera is connected to and the device that plays back images are different, turn both devices on.

When viewing images on AV equipment with multiple video input terminals (such as a TV), refer to the operation manual of the device and select the video input terminal to which the camera is connected.

- 4 Turn the camera on.**



- You are recommended to use the AC adapter kit K-AC8 (optional) if you intend to use the camera for a long time.
- Depending on the country or region, images and sound files may fail to be played back if the video output format is set different from the one in use there. If this happens, change the video output format setting. (p.170)
- The camera LCD monitor turns off while the camera is connected to AV equipment.
- Volume cannot be adjusted with the zoom button while the camera is connected to AV equipment.

Deleting Images

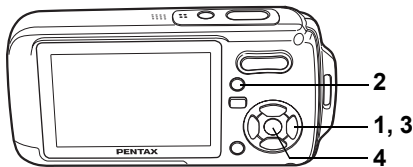

Delete images and sounds with mistakes or that are unnecessary.

When images or sounds are inadvertently deleted







Deleted images and sounds can be recovered with the Optio W10. (p.128)
Deleted images and sounds can be recovered even if the camera has been turned off after deletion as long as the SD memory card has not been removed. However, deleted images and sounds cannot be recovered after operations to write data such as taking pictures, recording movies, protecting images, saving DPOF settings, resizing images, or trimming images have been performed.

Deleting Single Images/Sound Files

You can delete single images and sound files one at a time.



Protected images and sound files cannot be deleted. (p.129)

- 1 Enter the  mode and use the four-way controller ( ) to choose the image/sound file you want to delete.**
- 2 Press the .**
The confirmation screen appears.
- 3 Use the four-way controller ( ) to select [Delete].**
- 4 Press the OK button.**
The image or sound file is deleted.





If you press the  button during Instant Review, the screen in Step 2 appears, enabling you to delete the image you have just taken. (p.43)

Recovering Deleted Images  p.128

Deleting a Sound File

If sound has been recorded with an image (p.156), you can delete the sound without deleting the image.

- 1 Enter the  mode and use the four-way controller (◀▶) to choose an image with sound.**
- 2 Press the  button.**
The confirmation screen appears.
- 3 Use the four-way controller (▲▼) to select [Delete Sound].**
- 4 Press the OK button.**

The sound file is deleted.



5



Select [Delete] in Step 3 above to delete both the image and sound file.

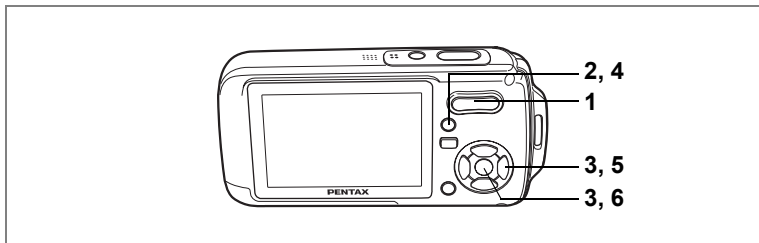

Deleting Selected Images and Sound Files (from Nine-Image Display)

You can delete several images/sound files selected from the nine-image display at once.



Protected images and sound files cannot be deleted.

- 1 In mode, press on the Zoom//Q button.**

Nine thumbnail images appear.

- 2 Press the button.**

appears on the images and sound files.



- 3 Use the four-way controller (>>><<) to choose the images and sound files that you want to delete and press the OK button.**



appears on the selected images and sound files.



If you select an image and press on the Zoom//Q button, the selected image appears in single-image display for as long as the button is pressed, enabling you to check whether you really want to delete it or not. (The display returns to the nine-image display when you release the button.) However, protected images cannot be displayed in single-image display.

4 Press the  button.

A confirmation dialog appears.

5 Use the four-way controller ( ) to select [Select & Delete].

6 Press the OK button.

The selected images and sound files are deleted.



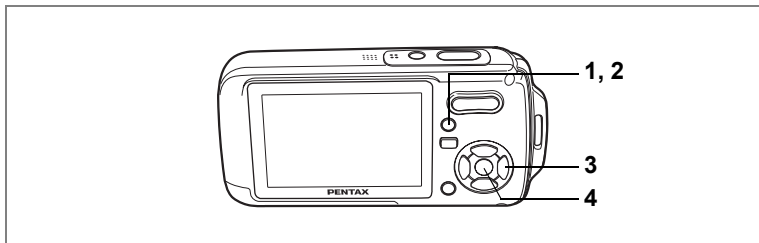





Deleting All Images

You can delete all the images and sound files at once.



Protected images and sound files cannot be deleted. (p.129)

- 1 Press the  button in  mode.**
A confirmation dialog appears.
- 2 Press the  button.**
A confirmation dialog appears.
- 3 Use the four-way controller ( ) to select [Delete All].**
- 4 Press the OK button.**
All the images and sound files are deleted.



Recovering Deleted Images  p.128

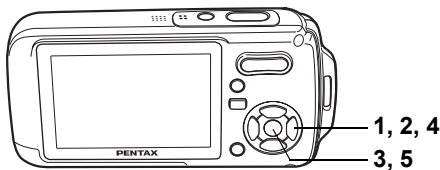

Recovering Deleted Images

You can recover images or sound files that were taken with this camera and then deleted.



After deleting an image, once the camera has been turned off after deletion or operations to write data such as taking pictures, recording movies, protecting images, saving DPOF settings, resizing images, or trimming images have been performed and the SD memory card is removed, the message “No image to be processed” appears in Step 3 and the deleted images and sound files cannot be recovered.

5

Playing Back and Deleting Images

- 1 After deleting a file, press the four-way controller (▼).**
The Playback Mode Palette appears.
- 2 Use the four-way controller (▲▼◀▶) to select .**
(Image Recovery).
- 3 Press the OK button.**
The number of recoverable images appears.
- 4 Use the four-way controller (▲▼) to select [Recover].**
- 5 Press the OK button.**
Deletion of the images is cancelled and the files are recovered.



Recovered images and sound files have the same file name as before they were deleted.

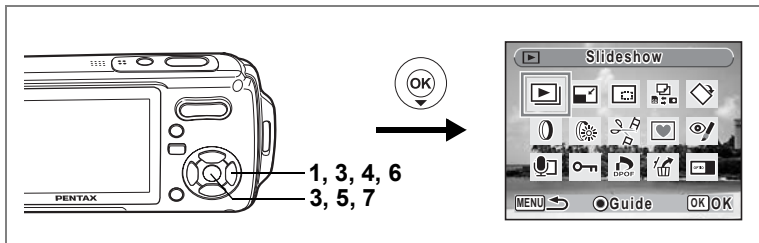

Protecting Images and Sound Files from Deletion (Protect)

You can protect stored images and sound files from being accidentally deleted.

- 1 Press the four-way controller (▼) in [▶] mode.**
The Playback Mode Palette appears.
- 2 Use the four-way controller (▲▼◀▶) to select [Protect].**
- 3 Press the OK button.**
The screen for selecting [Select image/sound] or [All Images/Sounds] appears.
- 4 Use the four-way controller (▲▼) to select [Select image/sound].**
- 5 Press the OK button.**
The message [Protect this image/sound] appears.
To protect another image or sound file, use the four-way controller (◀▶) to select another image or sound file.
- 6 Use the four-way controller (▲▼) to select [Protect].**
- 7 Press the OK button.**
The selected image or sound file is protected.



- To cancel the Protect setting, select [Unprotect] in Step 6.
- [▶] appears below the file number on protected images and sound files during playback.

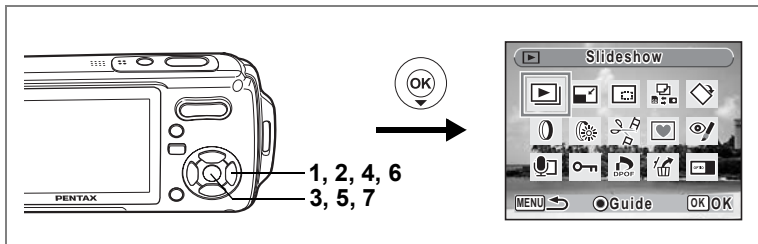

Protecting All Images and Sound Files

- 1 Press the four-way controller (▼) in [▶] mode.**
The Playback Mode Palette appears.
- 2 Use the four-way controller (▲▼◀▶) to select [Protect].**
- 3 Press the OK button.**
The screen for selecting [Select image/sound] or [All Images/Sounds] appears.
- 4 Use the four-way controller (▲▼) to select [All Images/Sounds].**
- 5 Press the OK button.**
The screen for selecting [Protect] or [Unprotect] appears.
- 6 Use the four-way controller (▲▼) to select [Protect].**
- 7 Press the OK button.**
All the images and sound files are protected.



Protected images and sound files will be deleted when the SD Memory Card or built-in memory is formatted.



To cancel the Protect setting on all your images and sound files, select [Unprotect] in Step 6.

Editing Images

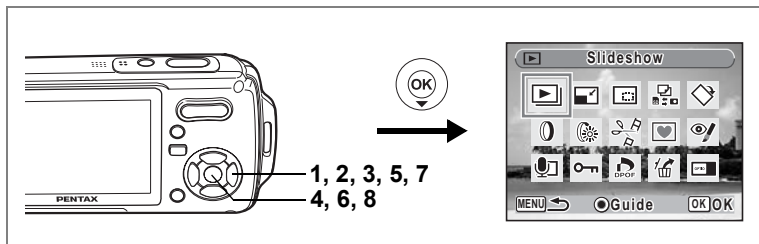

Changing the Image Size and Quality (Resize)

By changing the size and quality of a selected image, you can make the file size smaller than the original. You can use this function to continue taking pictures when the SD Memory Card or built-in memory is full, by making the images smaller and overwriting the original images to make more space available.



- Movies cannot be resized.
- You cannot select a larger resolution or higher quality than that of the original image.

- 1 Enter the mode and use the four-way controller (◀▶) to choose the image you want to resize.**
- 2 Press the four-way controller (▼).**
The Playback Mode Palette appears.
- 3 Use the four-way controller (▲▼◀▶) to select (Resize).**
- 4 Press the OK button.**
The screen for choosing the size and quality appears.
- 5 Select [Recorded Pixels] and [Quality Level].**

Use the four-way controller (◀▶) to choose the size and quality.

Use the four-way controller (▲▼) to switch between [Recorded Pixels] and [Quality Level].



6 Press the OK button.

A confirmation dialog for overwriting the image appears.
[Save as] is the only available option for protected images.

7 Use the four-way controller (▲▼) to select [Overwrite] or [Save as].

8 Press the OK button.

The resized image is saved.



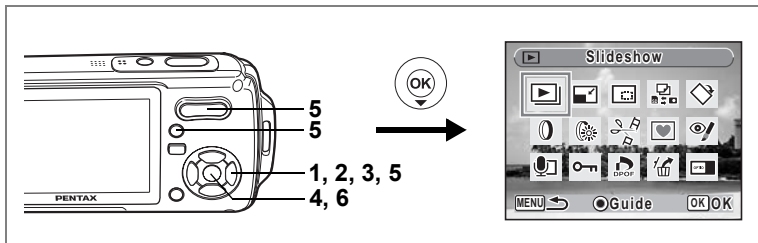

Trimming Images

You can delete the unwanted part of a picture and save the trimmed image as a separate image.

- 1** Enter the mode and use the four-way controller () to choose the image you want to trim.
- 2** Press the four-way controller ().
The Playback Mode Palette appears.
- 3** Use the four-way controller () to select (Trimming).
- 4** Press the OK button.
The Trimming screen appears.
- 5** Choose the trimming conditions.

Zoom//Q button

Changes the size of the trimmed section

Four-way controller ()

Moves the trimming position up, down, left and right

Green button Rotates the trimming frame

- 6** Press the OK button.

The trimmed image is saved with a new file name.

The trimmed image is saved in the same quality as the original image.

The number of recorded pixels is selected automatically according to the size of the trimmed section.

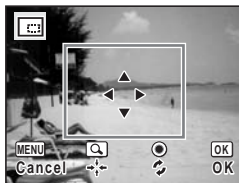

Movies cannot be trimmed.

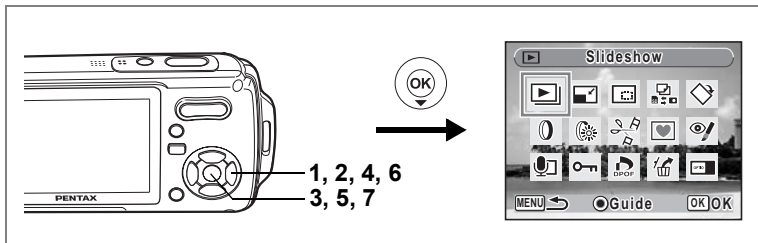

Copying Images and Sound Files

You can copy images and sound files from the built-in memory to the SD Memory Card and vice versa. This function can only be selected when an SD Memory Card has been inserted in the camera.



Make sure that the camera is turned off before inserting or removing the SD Memory Card.

- 1 Press the four-way controller (▼) in mode.**
The Playback Mode Palette appears.
- 2 Use the four-way controller (▲▼◀▶) to select .**
(Image/Sound Copy).
- 3 Press the OK button.**
The copying method selection screen appears.

To Copy Files from the Built-in Memory to the SD Memory Card

All the images and sound files in the built-in memory are copied to the SD Memory Card at once. Before copying the images, make sure that there is enough space in the SD Memory Card.

- 4 Use the four-way controller (▲▼) to select [→ SD].**
- 5 Press the OK button.**
All the images and sound files are copied.



To Copy Files from the SD Memory Card to the Built-in Memory

Selected images and sound files from the SD Memory Card are copied to the built-in memory one at a time.

4 Use the four-way controller (▲▼) to select [SD] → [●].

5 Press the OK button.

6 Use the four-way controller (◀▶) to select the file you want to copy.

7 Press the OK button.



The selected image/sound file is copied.



- If sound has been recorded with the image, the sound file is copied with the image.
- When a file is copied from the SD Memory Card to the built-in memory, it is assigned a new file name.

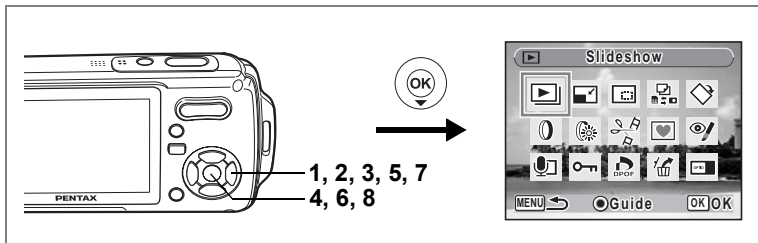

Using the Digital Filters

This function lets you edit selected images with digital filters to change the color, etc.

You can choose from nine filters: B&W, sepia, red, pink, purple, blue, green, yellow and soft.

1 Enter the mode and use the four-way controller () to choose the image you want to edit.

2 Press the four-way controller ().
The Playback Mode Palette appears.

3 Use the four-way controller () to select (Digital Filter).

4 Press the **OK** button.
The digital filter selection screen appears.

5 Use the four-way controller () to choose a digital filter.
You can preview the results of the filter effect.

6 Press the **OK** button.
A confirmation dialog for overwriting the image appears.

7 Use the four-way controller () to select [Overwrite] or [Save as].
[Save as] is the only available option for protected images.

8 Press the **OK** button.
The edited image is saved with the same number of recorded pixels and quality level as the original.

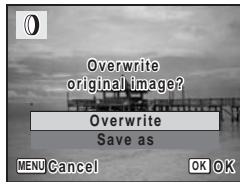

Using the Brightness Filter

This function lets you adjust the brightness of the selected image.

1 Enter the  mode and use the four-way controller (◀▶) to choose the image you want to edit.

2 Press the four-way controller (▼).

The Playback Mode Palette appears.

3 Use the four-way controller (▲▼◀▶) to select  (Brightness Filter).

4 Press the OK button.

The brightness adjustment screen appears.

5 Use the four-way controller (◀▶) to adjust the brightness.

You can preview the results of the brightness adjustment.



6 Press the OK button.

A confirmation dialog for overwriting the image appears.

7 Use the four-way controller (▲▼) to select [Overwrite] or [Save as].

[Save as] is the only available option for protected images.

8 Press the OK button.

The edited image is saved with the same number of recorded pixels and quality level as the original.





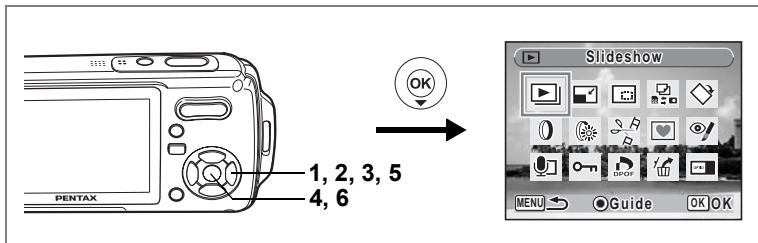







Movies or images taken with another camera cannot be edited using [Digital Filter] or [Brightness Filter]. An error message appears if you choose this function from the Playback Mode Palette and press the **OK** button.



Red-eye Compensation

You can correct images where the flash has caused the subject to appear with red eyes.

- 1 Enter the  mode and use the four-way controller ( ) to choose the image you want to correct.**
- 2 Press the four-way controller ().**
The Playback Mode Palette appears.
- 3 Use the four-way controller (   ) to select  (Red-eye Compensation).**
- 4 Press the OK button.**
A confirmation dialog for overwriting the image appears.
- 5 Use the four-way controller ( ) to select [Overwrite] or [Save as].**
[Save as] is the only available option for protected images.
- 6 Press the OK button.**



The edited image is saved with the same number of recorded pixels and quality level as the original.



- The red-eye compensation function cannot be used on movies or on images where red eyes cannot be detected on the camera. An error message appears in Step 4.
- The red-eye compensation function can only be used with still pictures taken with this camera.

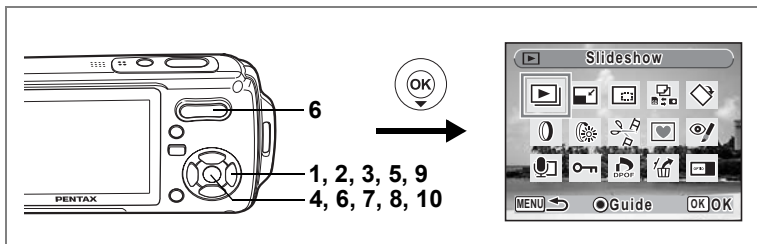

Adding a Frame (Frame Composite)

This function lets you add a decorative frame to still pictures. There are three frames already stored in the camera.

1 Enter the mode and use the four-way controller (</>) to choose the image to which you want to add a frame.

2 Press the four-way controller ().

The Playback Mode Palette appears.

3 Use the four-way controller (>>>) to select (Frame Composite).

4 Press the OK button.

A 9-frame display of the frame selection screen appears.

5 Use the four-way controller (>>>) to choose a frame.

6 Press the OK button or on the Zoom/> button.

The selected frame appears in single-image display.

You can choose another frame using either of the following operations.

- Use the four-way controller (>) to choose a different frame.
- Press the **MENU** button or on the Zoom/> button to return to the 9-frame display of the frame selection screen, and then perform Step 5 to choose a different frame.

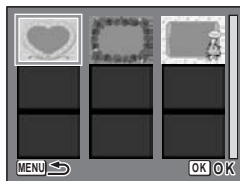

7 Press the OK button.

The frame position and size adjustment screen appears. Use the four-way controller (▲▼◀▶) to adjust the position of the image, and use the Zoom/☒/Q button to make the image larger or smaller.



8 Press the OK button.

A confirmation dialog for overwriting the image appears.

9 Use the four-way controller (▲▼) to select [Overwrite] or [Save as].

[Save as] is the only available option for protected images.



10 Press the OK button.

The edited image is saved with the recorded pixels of **3M**.

Caution

The Frame Composite function cannot be used on movies or images of size **2M** and smaller. An error message appears in Step 4.

6

Using a New Frame

Frames downloaded from a website or other source can be used when taking pictures. To display the frames available in the built-in memory or the SD Memory Card, in Step 3, select  (Frame Composite) and press the **OK** button.

Visit the PENTAX website at the URL below to download new frames.

http://www.pentax.co.jp/english/support/digital/optio_frame.html

Caution

- The three frames stored in the internal memory cannot be deleted.
- Up to 96 downloaded frames can be displayed. Including the three frames already stored in the internal memory, you can choose from up to 99 frames.

How to display the Movie Edit menu

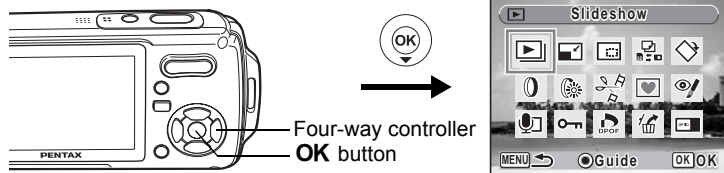

Editing Movies

You can select a frame from a recorded movie to save as a still picture, divide a movie into two or stitch two movies together.

1 Enter the mode and use the four-way controller () to choose the movie you want to edit.

To stitch two movies together (p.144), choose the first movie (first half).

2 Press the four-way controller ()

The Playback Mode Palette appears.

3 Use the four-way controller () to select (Movie Edit).

4 Press the OK button.

The movie edit selection screen appears.

Go to the following pages.

- “Saving a Frame from a Movie as a Still Picture” (p.142)
- “Dividing a Movie” (p.143)
- “Stitching Movies” (p.144)

Caution

Protected movies cannot be divided or stitched.

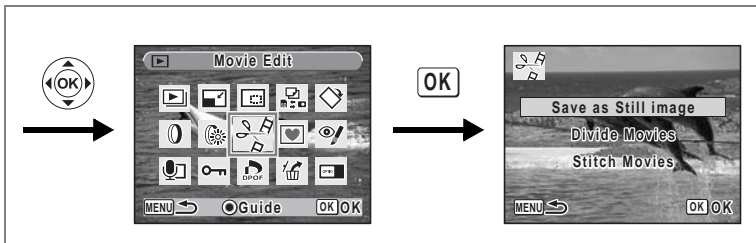

Saving a Frame from a Movie as a Still Picture

5 Select [Save as Still image] on the movie edit selection screen.

6 Press the OK button.

The screen appears for selecting a frame to be saved as a still picture.

7 Use the four-way controller (▲▼◀▶) to choose the frame you want to save.

- ▲ : Plays or pauses the movie
- ▼ : Stops the movie and returns to the first frame
- ◀ : Reverses the movie frame by frame
- ▶ : Advances the movie frame by frame

8 Press the OK button.

The selected frame is saved as a still picture.



How to display the Movie Edit menu

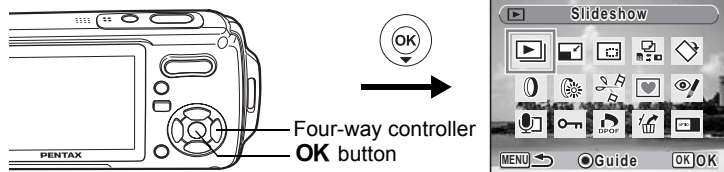

Dividing a Movie

5 Select **[Divide Movies]** on the movie edit selection screen.

6 Press the **OK** button.

The screen for choosing the dividing position appears.

7 Use the four-way controller (**▲▼◀▶**) to determine the dividing position.

▲ : Plays or pauses the movie

▼ : Stops the movie and returns to the first frame

◀ : Reverses the movie frame by frame

▶ : Advances the movie frame by frame

8 Press the **OK** button.

A confirmation dialog appears.

9 Use the four-way controller (**▲▼**) to select **[Divide]**.

10 Press the **OK** button.

The movie is divided at the specified position and the two portions are saved as new files.

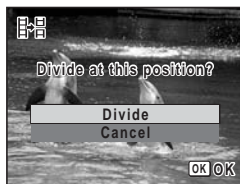

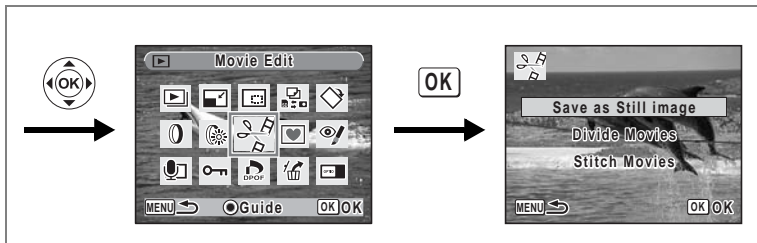

Stitching Movies

- 5 Select [Stitch Movies] on the movie edit selection screen.
- 6 Press the OK button.
The movie selection screen appears.
- 7 Use the four-way controller (◀▶) to choose the second movie (latter half).

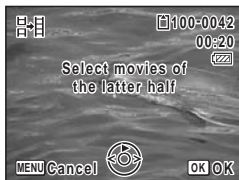

- 8 Press the OK button.
A confirmation dialog appears.
- 9 Use the four-way controller (▲▼) to select [Stitch].
- 10 Press the OK button.

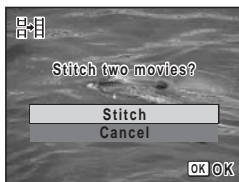

The two selected movies are stitched together and saved in the first movie file. (The movie that was selected as the first half is overwritten by the stitched movie and the movie that was selected as the second half is deleted.)



- When a stitched movie is played back, it may appear to stop for about one second at the point where the two movies were joined. This is because, in Movie Edit mode, the movie data is edited in units of one second, so if the last frame of the first movie lasts less than one second, it is drawn out to one second when it is joined to the second movie.
- When two movies are joined together, the second movie file is deleted.

Setting the Printing Service (DPOF)

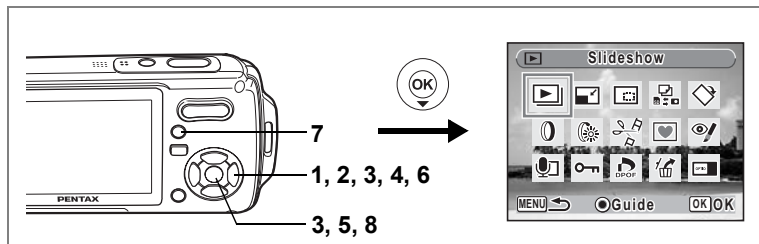

DPOF (Digital Print Order Format) is the format for storing print order data on still pictures captured with a digital camera. Once the print order data has been stored, the pictures can be printed according to the DPOF settings using a DPOF-compatible printer or photo processing lab. You cannot store print order data for movies or sound-only files.



Printing Single Images

Set the following items for each image.

Copies	Choose the number of copies up to 99.
Date	Specify whether you want the date inserted on the print or not.

- 1 In  mode, press the four-way controller (▼).**
The Playback Mode Palette appears.
- 2 Use the four-way controller (▲▼◀▶) to select  (DPOF).**
- 3 Press the OK button.**
The screen for selecting [Single Image] or [All Images] appears.
- 4 Use the four-way controller (▲▼) to select [Single Image].**



5 Press the OK button.

The message [DPOF setting for this image] appears.

To make DPOF settings for another image, use the four-way controller (◀▶) to select another image.

If DPOF settings have already been made for an image, the previous number of copies and date setting (☑ or ☐) will be displayed.



6 Use the four-way controller (▲▼) to choose the number of copies.

7 Use the Green button to choose whether to insert the date or not.

☑ (On) : The date will be imprinted.

☐ (Off) : The date will not be imprinted.

To continue setting DPOF print order data, use the four-way controller (◀▶) to choose another image and repeat Steps 6 and 7.



8 Press the OK button.

The DPOF settings are saved and the screen returns to the DPOF menu.



Depending on the printer or printing equipment at the photo processing lab, the date may not be imprinted on the pictures even if ☑ (On) was selected in the DPOF settings.



To cancel DPOF settings, set the number of copies to [00] in Step 6 and press the **OK** button.

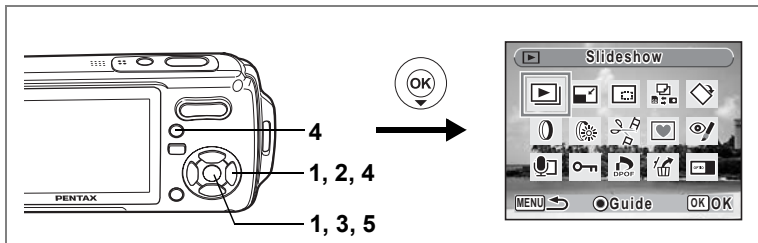

Printing All Images

When you choose the number of copies and whether or not to insert the date, the settings are applied to all the images stored in the camera.

- 1 Display the screen for DPOF settings in mode.**
Refer to Steps 1 to 3 on p.145.
- 2 Use the four-way controller () to select [All Images].**
- 3 Press the OK button.**

The message [DPOF setting for all images] appears.

- 4 Choose the number of copies and whether to insert the date or not.**

Refer to Steps 6 and 7 in "Printing Single Images" (p.146) for details of how to make the settings.

- 5 Press the OK button.**

The DPOF settings for all the images are saved and the camera returns to the DPOF setting screen.



The number of copies specified in the DPOF settings applies to all the images. Before printing, check that the number is correct.



Settings for single images are canceled when settings are made for all images.

Printing Using PictBridge

By connecting the camera to a printer that supports PictBridge using the USB cable (I-USB7) provided, you can print images directly from the camera without using a PC. Connect the camera to the printer and select the images you want to print and the number of copies on the camera.



- You are recommended to use the AC adapter kit K-AC8 when the camera is connected to the printer. The printer may not work properly or the image data may be lost if the battery runs out of power while the camera is connected to the printer.
- Do not disconnect the USB cable during data transfer.
- Depending on the model of printer, not all the settings made on the camera (such as print settings and DPOF settings) may be valid.
- A printing error may occur if the selected number of copies exceeds 500.
- Printing the index of the images (printing multiple images on a single sheet) cannot be performed directly from the camera. Make the settings on a printer supporting index printing function or use a PC.

6

Connecting the Camera to the Printer

- 1 Select [PictBridge] for the [USB Connection] mode on the [X] Setting] menu.**
Refer to “Changing the USB Connection Mode” (p.169).
- 2 Turn off the camera.**
- 3 Connect the camera to the printer using the USB cable provided.**
- 4 Turn the printer on.**
- 5 When the printer is ready to print, turn the camera on.**

The printing mode selection screen appears.

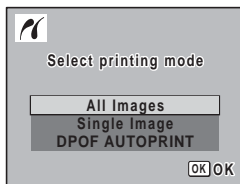

Printing Single Images

- 1 In the printing mode selection screen, use the four-way controller (▲▼) to select [Single Image].**

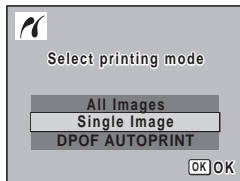

- 2 Press the OK button.**

The setting screen appears.

- 3 Use the four-way controller (◀▶) to choose an image to print.**

- 4 Use the four-way controller (▲▼) to choose the number of copies.**

You can print up to 99 copies.



- 5 Use the Green button to choose whether to insert the date or not.**

(On) : The date will be imprinted.

(Off) : The date will not be imprinted.

- 6 Press the OK button.**

A confirmation dialog appears.

To print the pictures according to the print settings on the printer, press the **OK** button.

To change the print settings, go to Step 7.

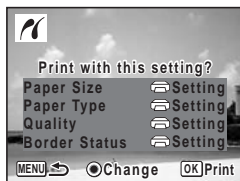

- 7 Press the Green button.**

The screen for changing the print settings appears.

- 8 Select [Paper Size] and press the four-way controller (▶).**

The Paper Size screen appears.

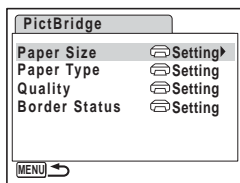

9 Use the four-way controller (▲▼◀▶) to choose the paper size.

You can only choose a size that is supported by your printer.

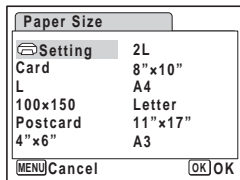

10 Press the OK button.

The Paper Size setting is saved, and the screen returns to the print settings screen.

11 Use the four-way controller (▲▼) to select [Paper Type] and press the four-way controller (▶).

A pull-down menu appears.

12 Use the four-way controller (▲▼) to select the paper type and press the OK button.

The Paper Type setting is saved, and the screen returns to the print settings screen. Set [Quality] and [Border Status] in the same way as in Steps 11 and 12.

If you select [⊞ Setting] for each print setting, images are printed according to the settings made on the printer.

Paper Type with more ★ supports higher quality paper.

Quality with more ★ indicates higher print quality.

A confirmation dialog appears after each item has been set.

13 Press the MENU button.

The screen returns to the confirmation dialog.

14 Press the OK button.

The image is printed according to the settings.

Press the **MENU** button to cancel printing.



- The power indicator lights while the camera is communicating with the printer, and blinks while the card is being accessed and during printing. Do not disconnect the USB cable while the power indicator is blinking.
- The [Paper Size], [Paper Type], [Quality] and [Border Status] settings are reset to the defaults when the camera is turned off.

Disconnecting the Cable from the Printer p.152

Printing All Images

- 1 In the printing mode selection screen, use the four-way controller (▲▼) to select [All Images].**

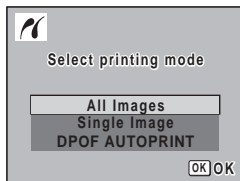

- 2 Press the OK button.**

The setting screen appears.

- 3 Choose the number of copies and whether to insert the date or not.**

The number of copies and date setting that you choose apply to all the images.

Refer to Steps 4 and 5 in "Printing Single Images" (p.149) for details of how to make the settings.

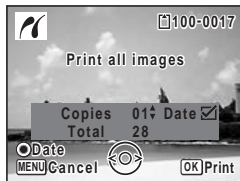

- 4 Press the OK button.**

A confirmation dialog appears.

Refer to Steps 7 to 11 of "Printing Single Images" (p.149 and p.150) for details of changing print settings.

- 5 Press the OK button on the print settings confirmation screen.**

All the images are printed according to the settings.

Press the **MENU** button to cancel printing.

Printing Using the DPOF Settings

1 In the printing mode selection screen, use the four-way controller (▲▼) to select [DPOF AUTOPRINT].

2 Press the **OK** button.

The DPOF settings you have made appear. Use the four-way controller (◀▶) to check the number of copies for each picture, whether to insert the date or not, and the total number of copies. Refer to p.145 for instructions on how to make the DPOF settings.

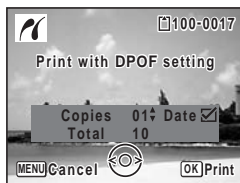

3 Press the **OK** button.

A confirmation dialog appears.

Refer to Steps 7 to 11 of “Printing Single Images” (p.149 and p.150) for details of changing print settings.

4 Press the **OK** button.

The images are printed according to the settings.

Press the **MENU** button to cancel printing.

Disconnecting the Cable from the Printer

Disconnect the USB cable from the camera and printer when you have finished printing.

1 Turn off the camera.

2 Disconnect the USB cable from the camera and printer.

Recording Sound (Voice Recording Mode)

You can record sound with the camera. The microphone is located on the top of the camera. When recording sound, aim the camera to obtain the best conditions.

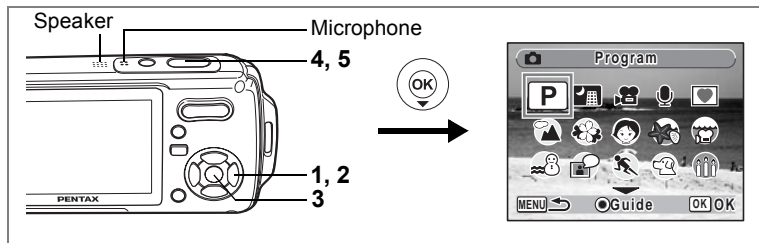

- 1 Press the four-way controller (▼) in mode.**
The Capture Mode Palette appears.
- 2 Use the four-way controller (▲▼◀▶) to select (Voice Recording).**

- 3 Press the OK button.**

The remaining recordable time and the recording time of the current file appear on the LCD monitor.

- Recording time
- Remaining recordable time

- 4 Press the shutter release button fully.**

Recording starts. The self-timer lamp blinks during recording.

When the Green button is pressed during recording, an index can be added to the current sound file.

- 5 Press the shutter release button fully.**

Recording stops.

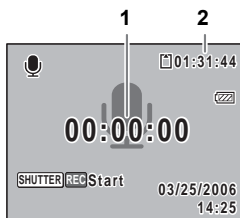





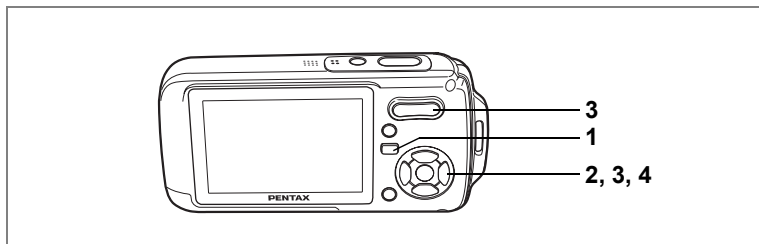

- If you press and hold down the shutter release button for more than one second in Step 4, recording continues until you take your finger off the button. This is useful for making short sound recordings, such as for the user sound in the [Sound] menu.
- Sound is saved in WAVE monaural files.
- Pressing the **OK** button clears the voice recording screen from the LCD monitor. Press the **OK** button again to display the voice recording screen.

Playing Back Sound

You can play back the sound files you made in  mode.



- 1 Press the  button.
- 2 Use the four-way controller ( ) to choose a sound file to play back.
- 3 Press the four-way controller ().



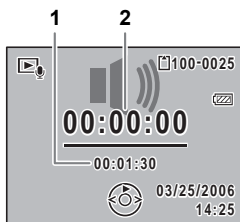

The sound file is played back.

1 Total file recording time

2 Playback time





The following operations can be performed during playback.

- Four-way controller () Pauses playback
- Zoom/ button () Increases the volume
- Zoom/ button () Reduces the volume



If there are no recorded indexes:

- Four-way controller () Reverses playback
- Four-way controller () Fast forwards playback

If there are recorded indexes:

- Four-way controller () Plays back starting from the previous index
- Four-way controller () Plays back starting from the next index

The following operations can be performed while playback is paused.

- Four-way controller () Resumes playback
- Four-way controller () Rewinds approx. 5 seconds
- Four-way controller () Advances approx. 5 seconds

- 4 Press the four-way controller ().

Playback stops.

Adding a Voice Memo to Images

You can add a voice memo to your still pictures.

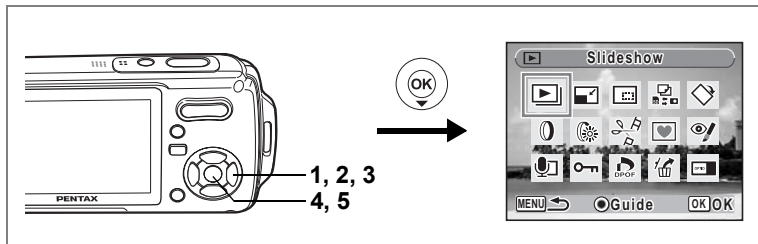

Recording a Voice Memo

- 1 Enter mode and use the four-way controller (◀▶) to choose the still picture to which you want to add a voice memo.
- 2 Press the four-way controller (▼).
The Playback Mode Palette appears.
- 3 Use the four-way controller (▲▼◀▶) to select (Voice Memo).
- 4 Press the OK button.



Recording starts. You can record until the SD Memory Card or built-in memory is full.

- 5 Press the OK button.

Recording stops.



- A voice memo cannot be added to an image that already has a voice memo or that was taken in Synchro Sound Record mode. Delete the old voice memo and record a new one. (p.124)
- A voice memo cannot be added to protected (Ⓚ) images (p.129).

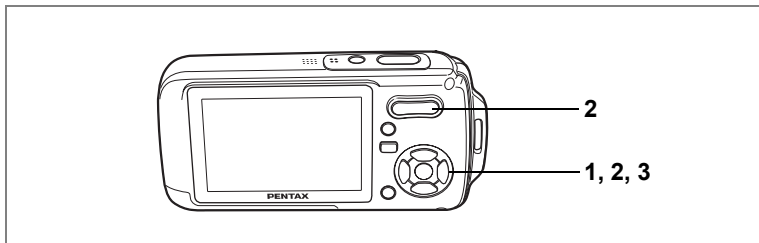

Playing Back a Voice Memo

- 1 Enter mode and use the four-way controller (◀▶) to choose the still picture with the voice memo that you want to play back.**

appears on images with voice memos in single-image display.



- 2 Press the four-way controller (▲).**

Playback starts.

The following operations can be performed during playback.

- Zoom/ button (▲) Increases the volume
- Zoom/ button (▲) Reduces the volume

- 3 Press the four-way controller (▼).**

Playback stops.



Sound files for images taken in Synchro Sound Record mode can be played back in the same manner.

Deleting a Sound File p.124

Camera Settings

How to display the [X Setting] menu

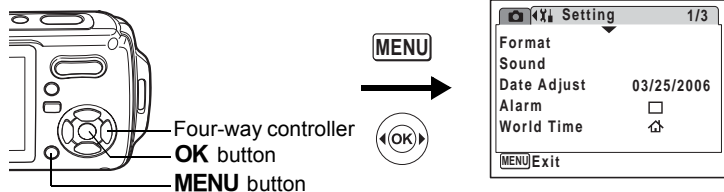

Formatting an SD Memory Card or the Built-in Memory

Formatting will delete all the data on the SD Memory Card. All the data in the built-in memory will be deleted if no SD Memory Card is inserted in the camera.

Caution:

- Do not remove the SD Memory Card during formatting as this may damage the card and render it unusable.
- Formatting will delete protected images and any data recorded on the card with a camera other than this camera.
- SD Memory Cards formatted on a PC or device other than the camera cannot be used. Be sure to format the card with the camera.

8

Settings

- 1 Use the four-way controller (▲ ▼) to select [Format] on the [X Setting] menu.**
- 2 Press the four-way controller (▶).**
The Format screen appears.
- 3 Use the four-way controller (▲ ▼) to select [Format].**
- 4 Press the OK button.**

When formatting is completed, the camera returns to Capture mode or Playback mode.

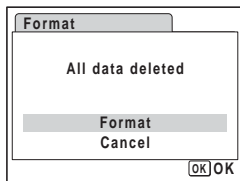

How to display the [X Setting] menu



Four-way controller

MENU button

MENU

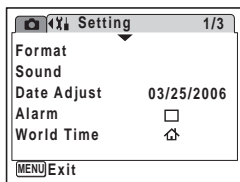

Changing the Date and Time

You can change the initial date and time settings. You can also set the style in which the date appears on the camera.

1 Use the four-way controller (▲▼) to select [Date Adjust] on the [X Setting] menu.

2 Press the four-way controller (▶).

The Date Adjust screen appears.

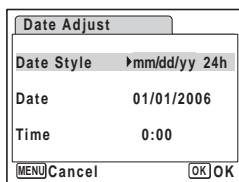

3 Press the four-way controller (▶).

The frame moves to [mm/dd/yy].

Depending on the initial setting or previous setting, [dd/mm/yy] or [yy/mm/dd] may be displayed.

4 Use the four-way controller (▲▼) to choose the date and time display style.

Choose [mm/dd/yy], [dd/mm/yy] or [yy/mm/dd].

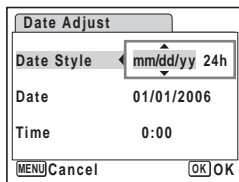

5 Press the four-way controller (▶).

The frame moves to [24h].

6 Use the four-way controller (▲▼) to select [24h] (24-hour display) or [12h] (12-hour display).

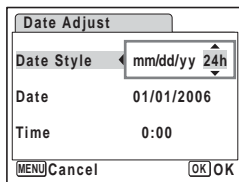

7 Press the four-way controller (▶).

The frame returns to [Date Style].

8 Press the four-way controller (▼).

The frame moves to [Date].

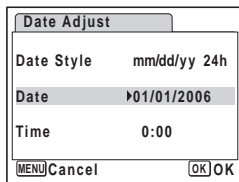

9 Press the four-way controller (▶).

The frame moves to one of the following items depending on the date style set in Step 4.

For [mm/dd/yy] month (Example: [01])

For [dd/mm/yy] day (Example: [01])

For [yy/mm/dd] year (Example: [2006])

The following operations and screens use [mm/dd/yy] as an example. The operations are the same even if another date style has been selected.

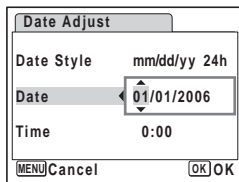

10 Use the four-way controller (▲▼) to change the month.

11 Press the four-way controller (▶).

The frame moves to the day field. Use the four-way controller (▲▼) to change the day. After changing the day, change the year in the same manner.

8

12 Change the time in the same way as in Steps 7 to 10.

If you selected [12h] in Step 6, the setting switches between am and pm corresponding to the time.

13 Press the OK button.

The date and time settings are saved.



When you finish the settings and press the **OK** button, the camera clock is reset to 00 seconds. To set the exact time, press the **OK** button when the time signal (on the TV, radio, etc.) reaches 00 seconds.

How to display the [X Setting] menu

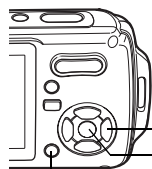

Four-way controller
OK button
MENU button

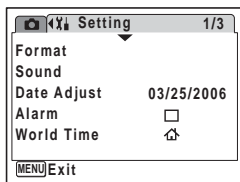

Changing the Sound Settings

You can adjust the volume of operation sounds and change the type of sound.

- 1 Use the four-way controller (▲▼) to select [Sound] on the [X Setting] menu.
- 2 Press the four-way controller (▶).
The Sound screen appears.

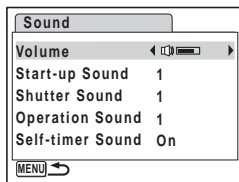

Changing the Operation Volume

- 3 Use the four-way controller (▲▼) to select [Volume].
- 4 Use the four-way controller (◀▶) to adjust the volume.
The selected volume is saved.
Set the volume to 0 to mute the start-up sound, shutter sound, operation sound, and self-timer sound.

Changing the Sound Type

- 5 Use the four-way controller (▲▼) to select [Start-up Sound].
- 6 Press the four-way controller (▶).
A pull-down menu appears.

- 7 Use the four-way controller (▲▼) to select [1], [2], [3], [Off] or [USER] and press the OK button.**

The selected sound type is saved.

- 8 Set [Shutter Sound], [Operation Sound] and [Self-timer Sound] in the same way as in Steps 5 to 7.**

Select [On], [Off] or [USER] for the self-timer sound.

- 9 Press the MENU button.**

The setting is changed and the screen returns to the [X Setting] menu.

Setting the User Sound

You can set the first two seconds of your favorite recorded sound as the user sound and then use this as the start-up sound or shutter sound. The sound to be used is recorded with the camera. (p.153)

- 1 Select [USER] in Steps 7 and 8 above.**

- 2 Press the OK button.**

The Playback screen appears if a sound that can be used as the user sound has been saved in the camera. USER appears for the sound set as the user sound.



- 3 Use the four-way controller (◀▶) to choose a sound file.**

Four-way controller (▲) Plays back the first two seconds of the sound file

Four-way controller (▼) Stops playback

- 4 Press the OK button.**

The selected sound is set as the user sound for the start-up sound or shutter sound.

How to display the [X Setting] menu

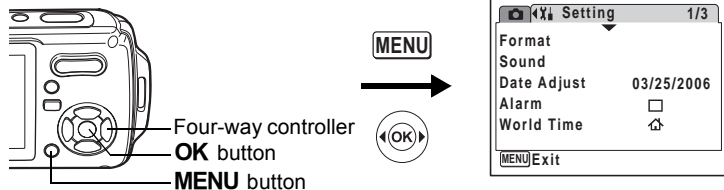

Setting the Alarm

You can set the alarm to ring at a specified time.

You can choose whether the alarm will ring at the same time every day or only once at the set time.

Setting the Alarm

- 1 Use the four-way controller (▲▼) to select [Alarm] on the [X Setting] menu**
- 2 Press the four-way controller (▶).**
The Alarm screen appears.
- 3 Press the four-way controller (▶).**
A pull-down menu appears.
- 4 Use the four-way controller (▲▼) to select [Off], [Once] or [Everyday] and press the OK button.**
- 5 Press the four-way controller (▼).**
Next, set the [Time].
- 6 Press the four-way controller (▶).**
The frame moves to the hour field.
- 7 Use the four-way controller (▲▼) to change the hour, then press (▶).**
The frame moves to the minute field.
Change the minutes in the same manner.

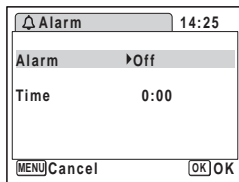

8 Press the OK button twice.

The screen returns to the [X Setting] menu. Check that [Alarm] is set to (On).

9 Press the OK button.

[Alarm is set] appears and the camera turns off.

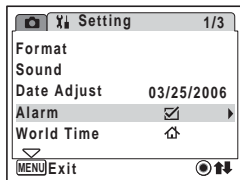

Checking the Alarm

1 Use the four-way controller (▲▼) to select [Alarm] on the [X Setting] menu.

Check that [Alarm] is set to (On).

2 Press the four-way controller (▶).

The Alarm screen appears. Check the alarm frequency and time.

3 Press the MENU button twice.

The camera returns to capture status.

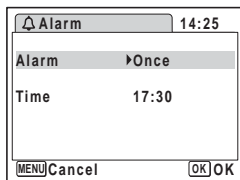

Turning the Alarm Off

The Clock mode screen appears and the alarm rings for one minute when the set time is reached while the camera is turned off.

You can stop the alarm by pressing any button on the camera while the alarm is ringing.



The alarm will not ring if the camera is on when the set time is reached.

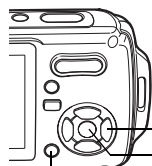

How to display the [X Setting] menu



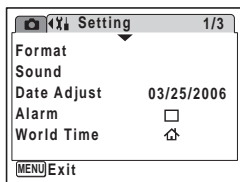
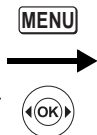











Four-way controller
OK button
MENU button



Setting the World Time

The date and time selected in “Setting the Date and Time” (p.38) and “Changing the Date and Time” (p.159) serve as the  (Hometown) date and time. By using the world time function, you can display the time in a city other than the Hometown ( Destination). This is useful when taking pictures in a different time zone.

Setting the Destination

- 1 Use the four-way controller ( ) to select [World Time] on the [X Setting] menu.**
- 2 Press the four-way controller ().**
The World Time screen appears.
- 3 Use the four-way controller ( ) to select  (Destination).**
- 4 Press the four-way controller ().**
The Destination screen appears. The city that is currently selected blinks on the map.
- 5 Use the four-way controller ( ) to change the Destination city.**
The current time, location and time difference of the selected city appear.
- 6 Use the four-way controller ( ) to select [DST].**
- 7 Use the four-way controller ( ) to select (On) or (Off).
Select (On) if the Destination city uses daylight saving time.**

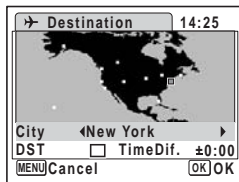

8 Press the OK button.

The World Time setting is saved.

9 Press the MENU button twice.

The camera returns to capture status with the current setting.



Select (Hometown) in Step 3 of p.165 to set the city and DST setting for the Hometown city.

Displaying the Time of the Destination on the LCD Monitor (Select Time)

1 Use the four-way controller (▲ ▼) to select [World Time] on the [X↓ Setting] menu.

2 Press the four-way controller (▶).

The World Time screen appears.

3 Use the four-way controller (▲ ▼) to select [Select time].

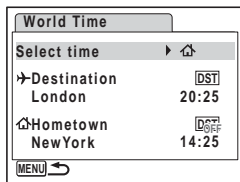

4 Press the four-way controller (▶).

A pull-down menu appears.

5 Use the four-way controller (▲ ▼) to select (Destination) or (Hometown).

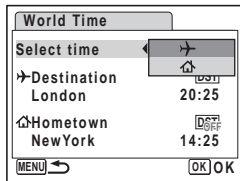

: Displays the time in the city selected as the Destination city

: Displays the time in the city selected as the Hometown city

6 Press the OK button.

The Select time setting is saved.

7 Press the MENU button twice.

The camera returns to mode or mode.

(Destination) appears on the LCD monitor when the camera returns to mode and World Time is selected.



How to display the [X Setting] menu

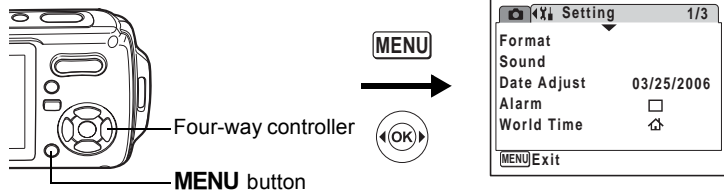

Changing the Display Language

You can change the language in which the menus, error messages, etc. are displayed.

You can choose from English, French, German, Spanish, Portuguese, Italian, Swedish, Dutch, Russian, Thai, Korean, Chinese (traditional and simplified) and Japanese.

- 1 Use the four-way controller (▲▼) to select [Language/言語] on the [X Setting] menu.**
- 2 Press the four-way controller (▶).**
The Language/言語 screen appears.
- 3 Use the four-way controller (▲▼◀▶) to select the language.**
- 4 Press the OK button.**
The selected language is set to be displayed.

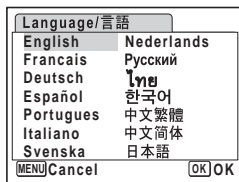

How to display the [X] Setting] menu

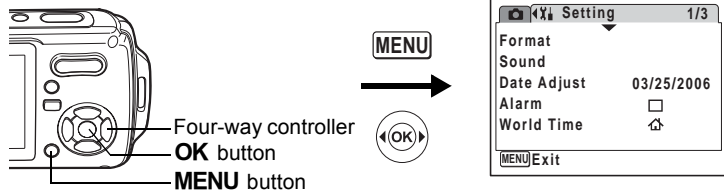

Changing the Image Folder Name

You can change the image folder name from the standard name to the date that pictures were taken. When the name is changed to the date, pictures are saved in separate folders by the date they were taken.

Folder Name

Standard	xxxPENTX (where xxx is the 3-digit folder number)
Date	xxx_mmdd (3-digit folder number_month day) * xxx_ddmm (3-digit folder number_day month) when the date style is set to [dd/mm/yy]

Picture taken with standard folder name
(Example: March 25)

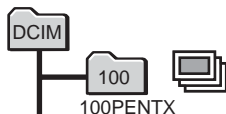

Folder name changed to date setting
(Example: March 25)

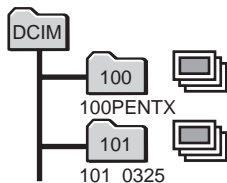

Next time a picture is taken
(Example: April 1)

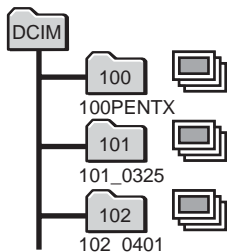

8

Settings

- 1 Use the four-way controller (▲▼) to select [Folder Name] on the [X] Setting] menu.**
- 2 Press the four-way controller (▶).**
A pull-down menu appears.
- 3 Use the four-way controller (▲▼) to select [Standard] or [Date].**
- 4 Press the OK button.**
The Folder Name setting is saved.

How to display the [X Setting] menu

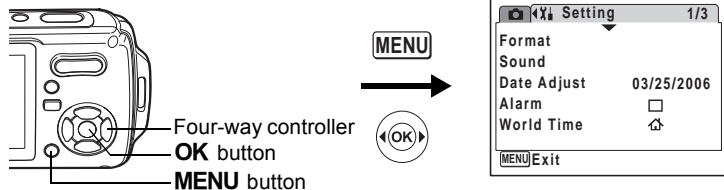

Changing the USB Connection Mode

Choose the appropriate USB connection mode depending on whether you are going to connect the USB cable to a PC or a PictBridge-compatible printer.



Refer to the PC Connection Manual for instructions on connecting the camera to a computer.

- 1 Use the four-way controller (▲▼) to select [USB Connection] on the [X Setting] menu.**
- 2 Press the four-way controller (▶).**
A pull-down menu appears.
- 3 Use the four-way controller (▲▼) to select [PC] or [PictBridge].**

[PC] : Select this option when transferring image data to a computer

[PictBridge] : Select this option when connecting the camera to a PictBridge-compatible printer

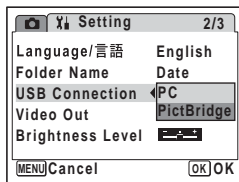

- 4 Press the OK button.**

The USB Connection setting is saved.



Do not connect the camera to your PC while [PictBridge] is selected for the USB Connection mode. And do not connect the camera to your printer while [PC] is selected.

How to display the [X Setting] menu

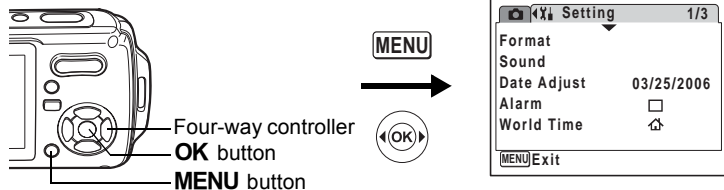

Changing the Video Output Format

When you connect the camera to AV equipment, choose the appropriate video output format (NTSC or PAL) for taking and playing back images.

1 Use the four-way controller (▲▼) to select [Video Out] on the [X Setting] menu.

2 Press the four-way controller (▶).

A pull-down menu appears.

3 Use the four-way controller (▲▼) to select [NTSC] or [PAL].

Choose the video output format to match the output format of the AV equipment.

4 Press the OK button.

The Video Out setting is saved.

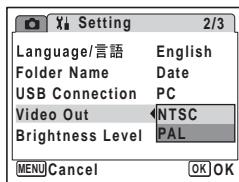

8

Settings



Depending on the country or region, images and sound files may fail to be played back if the video output format is set different from the one in use there. If this happens, change the video output format setting.

Connecting the Camera to AV Equipment p.122

How to display the [X Setting] menu

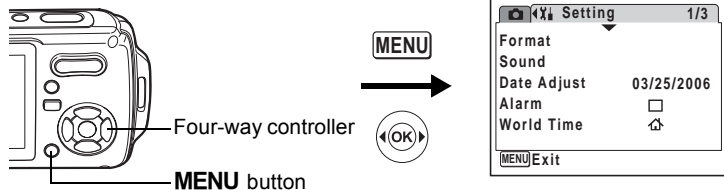

Adjusting the Brightness of the LCD Monitor

You can adjust the brightness of the LCD monitor.

- 1 Use the four-way controller (▲▼) to select [Brightness Level] on the [X Setting] menu.
- 2 Use the four-way controller (◀▶) to adjust the brightness.

The following setting is saved.

(Dark)

(Normal)

(Bright)

- 3 Press the MENU button.

The camera returns to Capture mode or Playback mode.

The LCD monitor is displayed with the set brightness. To change the brightness setting, perform the above steps again.

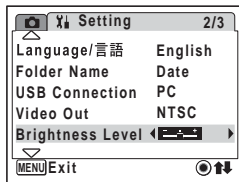

How to display the [X Setting] menu

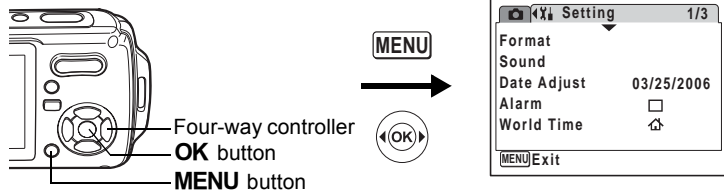

Using the Power Saving Function

You can save battery power by setting the LCD monitor to turn off automatically when no operation is performed for a fixed time. After the power saving function has been activated, you can turn the LCD monitor on again by pressing any of the buttons.

- 1 Use the four-way controller (▲▼) to select [Power Saving] on the [X Setting] menu.**
- 2 Press the four-way controller (▶).**
A pull-down menu appears.
- 3 Use the four-way controller (▲▼) to select [2min], [1min], [30sec], [15sec], [5sec] or [Off].**
- 4 Press the OK button.**

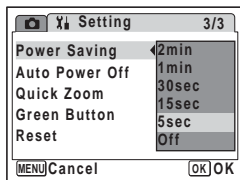

The Power Saving setting is saved.



Power Saving does not function in the following situations:

- in Playback mode
- while the camera is connected to a PC or printer
- when using the AC adapter
- while recording a movie

How to display the [X Setting] menu

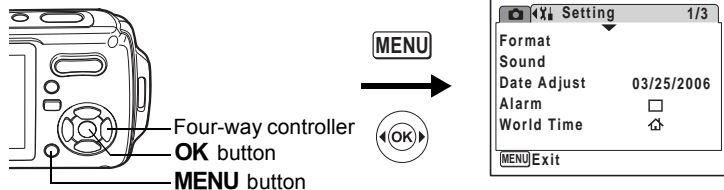

Setting Auto Power Off

You can set the camera to turn off automatically when no operation is performed for a fixed time.

- 1 Use the four-way controller (▲▼) to select [Auto Power Off] on the [X Setting] menu.**
- 2 Press the four-way controller (▶).**
A pull-down menu appears.
- 3 Use the four-way controller (▲▼) to select [5min], [3min] or [Off].**
- 4 Press the OK button.**

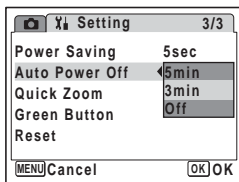

The Auto Power Off setting is saved.



Auto Power Off does not function in the following situations:

- during a slideshow or movie playback
- while the camera is connected to a PC or printer

How to display the Playback Mode Palette

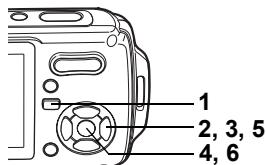

Changing the Start-up Screen

You can choose an image to be displayed as the start-up screen when the camera is turned on.

1 Press the button.

The camera enters mode.

2 Press the four-way controller ().

The Playback Mode Palette appears.

3 Use the four-way controller () to select (Start-up Screen).

4 Press the OK button.

The image selection screen appears.

5 Use the four-way controller () to choose an image for the start-up screen.

6 Press the OK button.

The Start-up Screen setting is saved.



- Once the start-up screen has been set, it will not be deleted even if the original image is deleted or the SD Memory Card or built-in memory is formatted.
- Select [Off] to hide the start-up screen.

How to display the [📷 Rec.Mode] menu

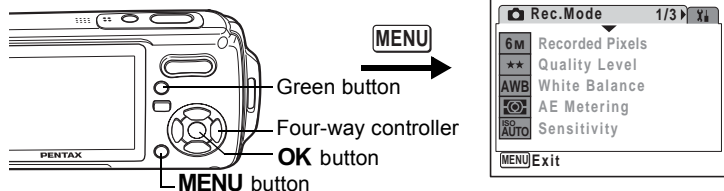

Changing the Menu Order

You can change the order of menu items in the [📷 Rec.Mode] and [⚙️ Setting] menus. Setting frequently used menu items to the top of the menu enables you to go straight to the menu of the desired item.

Ex.) To move [AE Metering] to the top of the [📷 Rec.Mode] menu

1 Select [AE Metering] on the [📷 Rec.Mode] menu.

2 Press the Green button.

The Reordering screen appears.

3 Use the four-way controller (▲▼) to move the setting in the desired direction.

In the example, [↑] is pressed to move [AE Metering] up.

4 Press the OK button.

Each time you press the four-way controller (▲▼), [AE Metering] moves up one position in the menu.

5 Once [AE Metering] is moved to the top, press the Green Button or the MENU button.

The Menu Order setting is saved.

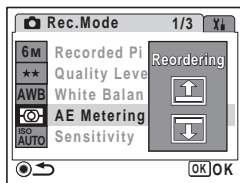

How to display the [X Setting] menu

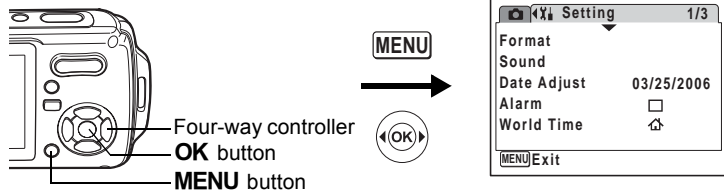

Resetting to Default Settings (Reset)

You can reset the camera settings to their defaults. Refer to “Default Settings” (p.180) for the reset settings.

- 1 Use the four-way controller (▲▼) to select [Reset] on the [X Setting] menu.**
- 2 Press the four-way controller (▶).**
The Reset screen appears.
- 3 Use the four-way controller (▲▼) to select [Reset menu setting].**
- 4 Press the OK button.**
A confirmation dialog for resetting the menu setting appears.
- 5 Use the four-way controller (▲▼) to select [Reset].**
- 6 Press the OK button.**
The settings return to the defaults.

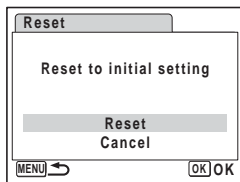

The following settings are not affected by resetting:
Date Adjust, Language/言語, World Time, Video Out and Menu Order.

Resetting the Menu Order

You can reset the menu order to its default.

- 1 Use the four-way controller (▲▼) to select [Reset] on the [X Setting] menu.**
- 2 Press the four-way controller (▶).**
The Reset screen appears.

- 3 Use the four-way controller (▲ ▼) to select [Reset menu item order].**
- 4 Press the OK button.**
A confirmation dialog for resetting the menu item order appears.
- 5 Use the four-way controller (▲ ▼) to select [Reset].**
- 6 Press the OK button.**
The menu order is reset.

Displaying the Clock Mode

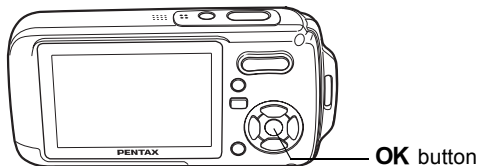

You can use the camera as a clock. With the camera turned off, press and hold down the **OK** button to display the clock on the LCD monitor.

1 Press and hold down the **OK** button.

The camera turns on and the clock appears on the screen.

The camera turns off automatically after approximately 10 seconds.

Pressing the power switch turns the camera off immediately.



List of World Time Cities

Refer to the following list of cities when setting the World Time.

Region	City	Region	City
North America	Honolulu	Africa/ West Asia	Jerusalem
	Anchorage		Nairobi
	Vancouver		Jeddah
	San Francisco		Tehran
	Los Angeles		Dubai
	Calgary		Karachi
	Denver		Kabul
	Chicago		Male
	Miami		Delhi
	Toronto		Colombo
	New York		Kathmandu
Halifax	Dacca		
Central and South America	Mexico City	East Asia	Yangon
	Lima		Bangkok
	Santiago		Kuala Lumpur
	Caracas		Vientiane
	Buenos Aires		Singapore
	Sao Paulo		Phnom Penh
	Rio de Janeiro		Ho Chi Minh
Europe	Lisbon		Jakarta
	Madrid		Hong Kong
	London		Beijing
	Paris		Shanghai
	Amsterdam		Manila
	Milan		Taipei
	Rome		Seoul
	Berlin	Tokyo	
	Stockholm	Guam	
	Athens	Oceania	Perth
	Helsinki		Adelaide
Moscow	Sydney		
Africa/ West Asia	Dakar		Noumea
	Algiers		Wellington
	Johannesburg	Auckland	
	Istanbul	Pago Pago	
	Cairo		

Default Settings

The table below lists the factory default settings.

The meaning of the indications for menu items with a default setting is explained below.

Last Memory Setting

Yes : The current setting (last memory) is saved when the camera is turned off.

No : The setting returns to the default setting when the camera is turned off.

* : The setting depends on the [Memory] setting (p.103).

Reset Setting

Yes : The setting returns to the default setting with the Reset function (p.176).

No : The setting is saved even after reset.

● [📷 Rec.Mode] Menu Items

Item		Default Setting	Last Memory Setting	Reset Setting	Page
Recorded Pixels		[6M] (2816×2112)	Yes	Yes	p.89
Quality Level		★★ (Better)	Yes	Yes	p.91
White Balance		AWB (Auto)	*	Yes	p.92
AE Metering		[📷] (Multi-segment)	*	Yes	p.94
Sensitivity		Auto	*	Yes	p.96
EV Compensation		±0.0	*	Yes	p.82
AF Setting	Focusing Area	[] (Multiple)	Yes	Yes	p.97
	Focus Limiter	On	Yes	Yes	p.98
Movie	Recorded Pixels	[640] (640×480)	Yes	Yes	p.107
	Quality Level	★★★ (Best)	Yes	Yes	p.108
	Color Mode	Full Color	Yes	Yes	p.110
	Frame Rate	30fps	Yes	Yes	p.109
	Movie anti-shake	On	Yes	Yes	p.111
	Optical Zoom	Off	Yes	Yes	p.112
Interval Shoot	Interval	10 sec	Yes	Yes	p.78
	Number of Shot	2 pictures	Yes	Yes	p.78
	Start Time	In 0 hr 0 min	Yes	Yes	p.78
Digital Zoom		On	*	Yes	p.81
Instant Review		1 sec	Yes	Yes	p.99

Item		Default Setting	Last Memory Setting	Reset Setting	Page
Memory	Flash Mode	On	—	Yes	p.87
	Drive Mode	Off	—	Yes	p.76, p.77, p.78
	Focus Modes	Off	—	Yes	p.85
	Zoom Position	Off	—	Yes	p.80
	MF Position	Off	—	Yes	p.86
	White Balance	Off	—	Yes	p.92
	Sensitivity	Off	—	Yes	p.96
	EV Compensation	Off	—	Yes	p.82
	AE Metering	Off	—	Yes	p.94
	Digital Zoom	On	—	Yes	p.81
	DISPLAY	Off	—	Yes	p.83, p.118
File #	On	—	Yes	—	
Sharpness		Normal	Yes	Yes	p.100
Saturation		Normal	Yes	Yes	p.101
Contrast		Normal	Yes	Yes	p.102

● [M Setting] Menu Items















Item		Default Setting	Last Memory Setting	Reset Setting	Page
Sound	Volume	3	Yes	Yes	p.161
	Start-up Sound	1	Yes	Yes	
	Shutter Sound	1	Yes	Yes	
	Operation Sound	1	Yes	Yes	
	Self-timer Sound	On	Yes	Yes	
Date Adjust	Date Style (date)	According to initial setting	Yes	No	p.38
	Date Style (time)	According to initial setting	Yes	No	
	Date	According to initial setting	Yes	No	
	Time	According to initial setting	Yes	No	
Alarm	Alarm Setting	Off	Yes	Yes	p.163
	Time	0:00	Yes	Yes	
World Time	World Time Setting	Off	Yes	Yes	p.165
	Destination (City)	Same as Hometown	Yes	No	
	Destination (DST)	Same as Hometown	Yes	No	
	Hometown (City)	According to initial setting	Yes	No	
	Hometown (DST)	According to initial setting	Yes	No	

Item	Default Setting	Last Memory Setting	Reset Setting	Page
Language/言語	According to initial setting	Yes	No	p.36
Folder Name	Date	Yes	Yes	p.168
USB Connection	PC	Yes	Yes	p.169
Video Out	According to initial setting	Yes	No	p.170
Brightness Level	Normal	Yes	Yes	p.171
Power Saving	5 sec	Yes	Yes	p.172
Auto Power Off	3 min	Yes	Yes	p.173
Quick Zoom	Off	Yes	Yes	p.117
Green Button	Green Mode	Yes	Yes	p.58

● Playback Mode Palette Items

Item	Default Setting	Last Memory Setting	Reset Setting	Page
Slideshow	Interval	3 sec	Yes	p.119
	Screen Effect	Wipe	Yes	
	Sound Effect	On	Yes	
Digital Filter	B&W	No	—	p.136
Brightness Filter	Standard	No	—	p.137
Start-up Screen	Optio Logo screen	Yes	Yes	p.174

● Key Operation

Item	Function	Default Setting	Last Memory Setting	Reset Setting	Page
 button	Operation Mode	 mode	—	—	—
Zoom/     button	Zoom Position	Full wide-angle	*	Yes	p.80
Four-way controller	 Drive Mode	 (Standard)	*	Yes	p.76, p.77, p.78
	 Shooting Mode	 (Program)	Yes	Yes	p.53
	 Flash Mode	 (Auto)	*	Yes	p.87
	 Focus Modes	AF (Standard)	*	Yes	p.85
MENU button	Menu Display	Capture mode:  Rec.Mode] menu Playback mode: [ Setting] menu	—	—	p.48
OK/DISPLAY button	Information Display	Normal	*	Yes	p.83, p.118

Functions Available for Each Shooting Mode

Yes: Can be set and function is available.

No : Cannot be set.

: Can be set but function is not available.

(Auto)	Yes	Yes	Yes	No*3	No	Yes	No*3	Yes	Yes	Yes
(Flash Off)	Yes	Yes	Yes	Yes*3	No	Yes	Yes*3	Yes	Yes	Yes
(Flash On)	No	Yes	Yes	No*3	No	Yes	No*3	Yes	Yes	Yes
(Auto + Red-eye)	No	Yes	Yes	No*3	No	Yes	No*3	Yes	Yes	Yes
(Flash On + Red-eye)	No	Yes	Yes	No*3	No	Yes	No*3	Yes	Yes	Yes
(Soft)	No	Yes	Yes	No*3	No	Yes	No*3	Yes	Yes	Yes
(Self-timer)	Yes*1	Yes	Yes	Yes	No	Yes	Yes	Yes	Yes	Yes
(2 Sec. Self-timer)	Yes*1	Yes	Yes	Yes	No	Yes	Yes	Yes	Yes	Yes
(Continuous Shooting)	No	Yes	No	No	No	No	No	Yes	No	No
(HS Cont. Shooting)	No	Yes	No	No	No	No	No	Yes	No	No
(Interval Shoot)	No	Yes	Yes	No	No	No	No	Yes	Yes	No
AF (Standard)	Yes	Yes	Yes	Yes	No	Yes	Yes	Yes	Yes	Yes
(Macro)	Yes	Yes	Yes	Yes	No	Yes	Yes	Yes	Yes	Yes
(Infinity)	No	Yes	Yes	Yes	No	Yes	Yes	Yes	Yes	Yes
PF (Pan Focus)	No	Yes	Yes	Yes	No	Yes	Yes	Yes	Yes	Yes
MF (Manual Focus)	No	Yes	Yes	Yes	No	Yes	Yes	Yes	Yes	Yes
Recorded Pixels	No	Yes	Yes	#*4	#	No*8	#*4	Yes	Yes	Yes
Quality Level	No	Yes	Yes	#*4	#	No*9	#*4	Yes	Yes	Yes
White Balance	No	Yes	No	Yes	#*7	Yes	No	No	No	Yes
AE Metering	No	Yes	No*2	#	#	Yes	#	No*2	No*2	Yes
Sensitivity	No	Yes	Yes	Yes	#	Yes	Yes	Yes	Yes	Yes
EV Compensation	No	Yes	Yes	Yes*5	#	Yes	Yes*5	Yes	Yes	Yes
Focusing Area	No	Yes	Yes	#	#	Yes*10	Yes	Yes	No*11	Yes*10
Focus Limiter	No	Yes	Yes	#	#	Yes	Yes	Yes	Yes	Yes
Movie	No	#	#	Yes	#	Yes	Yes	#	#	#
Digital Zoom	No	Yes	Yes	Yes	#	Yes	Yes	Yes	No	Yes
Instant Review	No	Yes	Yes	#	#	Yes	#	Yes	Yes	#
Memory	No	Yes	Yes	Yes*6	Yes*6	Yes	Yes*6	Yes	Yes	Yes
Sharpness	No	Yes	No	Yes	#	Yes	No	No	No	Yes
Saturation	No	Yes	No	Yes	#	Yes	No	No	No	Yes
Contrast	No	Yes	No	Yes	#	Yes	No	No	No	Yes

*1 If you select one of these functions in another shooting mode and then enter the Green mode, only the function selected is available.

*2 Fixed at

*3 Fixed at (flash off)

*4 Follows setting for [Movie]

*5 Not available during recording

*6 Some related settings are applied

*7 (Manual) is not available

		SOFT							
Yes	Yes	Yes	No*3	Yes	Yes	Yes	Yes	Yes	(Auto)
Yes	Yes	Yes	Yes*3	Yes	Yes	Yes	Yes	Yes	(Flash Off)
Yes	Yes	Yes	No*3	Yes	Yes	Yes	Yes	Yes	(Flash On)
Yes	Yes	Yes	No*3	Yes	Yes	Yes	Yes	Yes	(Auto + Red-eye)
Yes	Yes	Yes	No*3	Yes	Yes	Yes	Yes	Yes	(Flash On + Red-eye)
Yes	Yes	Yes	No*3	Yes	Yes	Yes	Yes	Yes	(Soft)
Yes	Yes	Yes	Yes	Yes	Yes	Yes	Yes	Yes	(Self-timer)
Yes	Yes	Yes	Yes	Yes	Yes	Yes	Yes	Yes	(2 Sec. Self-timer)
Yes	Yes	No	No	Yes	Yes	Yes	No	Yes	(Continuous Shooting)
Yes	Yes	No	No	Yes	Yes	Yes	No	Yes	(HS Cont. Shooting)
Yes	Yes	Yes	Yes	Yes	Yes	Yes	Yes	Yes	(Interval Shoot)
Yes	Yes	Yes	No*12	Yes	Yes	Yes	Yes	Yes	AF (Standard)
Yes	Yes	Yes	No*12	Yes	Yes	Yes	Yes	Yes	(Macro)
Yes	Yes	Yes	Yes*12	Yes	Yes	Yes	Yes	Yes	(Infinity)
Yes	Yes	Yes	No*12	Yes	Yes	Yes	Yes	Yes	PF (Pan Focus)
Yes	Yes	Yes	No*12	Yes	Yes	Yes	Yes	Yes	MF (Manual Focus)
Yes	Yes	Yes	Yes	Yes	Yes	Yes	Yes	No*14	Recorded Pixels
Yes	Yes	Yes	Yes	Yes	Yes	Yes	Yes	Yes	Quality Level
No	No	No	No	No	No	No	No	Yes	White Balance
No*2	No*2	No*2	No*2	No*2	No*2	No*2	No*2	No*2	AE Metering
Yes	Yes	Yes	No*13	Yes	Yes	Yes	Yes	Yes	Sensitivity
Yes	Yes	Yes	No	Yes	Yes	Yes	Yes	Yes	EV Compensation
Yes	Yes	Yes	#	Yes	No*10	Yes	No*11	Yes	Focusing Area
Yes	Yes	Yes	#	Yes	Yes	Yes	Yes	Yes	Focus Limiter
#	#	#	#	#	#	#	#	#	Movie
Yes	Yes	Yes	Yes	Yes	Yes	Yes	No	Yes	Digital Zoom
Yes	Yes	Yes	Yes	Yes	Yes	Yes	Yes	Yes	Instant Review
Yes	Yes	Yes	Yes	Yes	Yes	Yes	Yes	Yes	Memory
No	No	No	No	No	No	No	No	No	Sharpness
No	No	No	No	No	No	No	No	No	Saturation
No	No	No	No	No	No	No	No	No	Contrast

*8 Set at (2048×1536)

*9 Fixed at ★★

*10 (Automatic Tracking AF) is not available

*11 Set to (Multiple) for Face Recognition AF

*12 Fixed at (Infinity)

*13 Fixed at 64

*14 Set at (1280×960)

Optional Accessories

A number of dedicated accessories are available for this camera.

AC adapter kit K-AC8 (AC adapter D-AC8, AC plug cord)

Battery charger kit K-BC8 (*) (Battery charger D-BC8, AC plug cord)

AC plug cord name differs depending on the country.

Rechargeable lithium-ion battery D-LI8 (*)

USB cable I-USB7 (*)

AV cable I-AVC7 (*)

Strap

O-ST20 (*)

O-ST24 Genuine leather strap

O-ST8 Silver chain strap

O-ST30 Waterproof strap for underwater use

Camera case

O-CC48

Products marked with an asterisk (*) are the same as those supplied with the camera.

Messages

Messages such as the following may appear on the LCD monitor during camera operation.

Battery depleted	The battery is exhausted. Charge the battery using the battery charger. (p.22)
Memory card full	The SD Memory Card is full and no more images can be saved. Insert a new SD Memory Card or delete unwanted images. (p.28, p.123) Change the quality level or recorded pixels of recorded images and try again. (p.131)
Memory card error	Shooting and playback are impossible due to a problem with the SD Memory Card. You may be able to display or copy the images on the card using a PC.
Card not formatted	The SD Memory Card you have inserted is unformatted or has been formatted on a computer or other device and is not compatible with this camera. (p.158)
Card locked	The SD Memory Card is write-protected. (p.30)
Compression error	This message appears when you have exceeded the capacity limit of the SD Memory Card while taking pictures.
No image/sound	There are no image/sound files on the SD Memory Card.
Movie recording stopped	This message appears when the internal temperature of the camera has exceeded normal operating limits while recording a movie.
Deleting	This message appears when deleting an image or sound file.
Camera cannot display this image	You are trying to play back an image or sound in a format not supported by this camera. You may be able to play it back on another brand of camera or your computer.
Image folder could not be created	The largest file number (9999) has been assigned to an image in the largest folder number (999) and no more images can be saved. Insert a new SD Memory Card or format the card. (p.158)
Protected	The image or sound file you are trying to delete is protected.











Data being recorded	This message appears when you try to switch to  mode while an image is still being recorded, or when the protect setting or DPOF setting is being changed. It disappears after the image is recorded or the setting is changed.
Data being processed	This message appears when the camera takes more than five seconds to display an image due to image processing, or when the SD Memory Card or built-in memory is being formatted.
Alarm is set	This message appears when the alarm is set and before the camera automatically turns off.

Messages such as the following may appear on the LCD monitor when using the PictBridge function.

No paper in the printer	There is no paper in the printer.
No ink in the printer	There is no ink in the printer.
Printer error	An error message has been sent from the printer.
Data error	A data error message has been sent from the printer.
Paper stuck in the printer	The paper is stuck in the printer.

Troubleshooting

Problem	Cause	Remedy
Camera will not turn on	Battery is not installed	Check if battery is installed. If not, install battery.
	Battery is installed incorrectly	Check orientation of battery. Reinsert battery according to ⊕ ⊖ symbols. (p.23)
	Battery power is low	Charge the battery.
No image on LCD monitor	Camera is connected to a PC	LCD monitor is off when camera is connected to a computer.
	Camera is connected to a TV	LCD monitor is off when camera is connected to a TV.
	LCD monitor is set to OFF	Press the OK/DISPLAY button to turn LCD monitor on. (p.83)
	Image is displayed but is hard to see	Image on LCD monitor may be hard to see when taking pictures outside in sunlight. Increase brightness of LCD monitor. (p.171)
Shutter will not release	Flash is charging	Pictures cannot be taken while the flash is charging. Wait until charging is finished.
	No available space on SD Memory Card or in the built-in memory	Insert SD Memory Card with available space or delete unwanted images. (p.28, 123)
	Recording	Wait until recording is finished.
Picture is dark	Subject is too far away in a dark environment, such as a night scene	Picture becomes dark if subject is too far away. Take picture within range of flash.

Problem	Cause	Remedy
Subject is not in focus	Subject is difficult to focus on with autofocus	Lock focus on another object located at same distance (press shutter release button halfway), then aim at target and press shutter release button fully (p.41), or use Manual Focus mode. (p.86)
	Subject is not in focusing area	Position subject in focus frame in middle of LCD monitor. If the subject is outside the focusing area, aim the camera at the subject and lock the focus (press shutter release button halfway), then compose picture and press the shutter release button fully.
	Subject is too close	Set focus mode to  . (p.85)
	Focus mode is set to 	Normal pictures will be out of focus if taken with focus mode set to  .
Flash does not discharge	Flash mode is set to  (flash off)	Set to Auto or  (Flash On). (p.87)
	Drive mode is set to  or  Focus mode is set to  Shooting mode is set to  ,  or 	Flash will not discharge in these modes.
USB connection with computer does not work properly	USB connection mode is set to [PictBridge]	Change the USB connection mode to [PC]. (p.169)
USB connection with printer does not work properly	USB connection mode is set to [PC]	Change the USB connection mode to [PictBridge]. (p.148)

Static electricity may occasionally prevent the camera from operating correctly. If this should occur, try removing and then reloading the battery. If the camera turns on and operates properly, this indicates that there is no malfunction. You can use the camera as usual.

Main Specifications

Type	Fully automatic compact digital still camera with built-in zoom lens	
Effective Pixels	6.0 megapixels	
Sensor	6.18 megapixels (total pixels) 1/2.5 inch interline transfer CCD with a primary color filter	
Recorded Pixels	Still Picture	6M (2816×2112 pixels), 5M (2560×1920 pixels) 4M (2304×1728 pixels), 3M (2048×1536 pixels) 2M (1600×1200 pixels), 1280 (1280×960 pixels) 1024 (1024×768 pixels), 640 (640×480 pixels)
	Movie	640 (640×480 pixels), 320 (320×240 pixels)
Sensitivity	Auto, manual (64/100/200/400/800: Standard Output Sensitivity)	
File Format	Still Picture	JPEG (Exif 2.2), DCF, DPOF, PictBridge, PRINT Image Matching III
	Movie	MOV (QuickTime Motion JPEG), VGA video, approx. 30fps/15fps, PCM system, monaural sound, full color/sepia/black and white
	Sound	Voice memo, voice recording: WAVE (PCM) system, monaural, Synchro sound record
Quality Level	Still Picture	★★★ "Best", ★★ "Better", ★ "Good"
Storage Medium	Built-in memory (approx. 10.5 MB), SD Memory Card	

Approximate Image Storage Capacity and Recording Time

Still Picture

	★★★ (Best)		★★ (Better)		★ (Good)	
	Built-in Memory	128MB	Built-in Memory	128MB	Built-in Memory	128MB
6M 2816×2112	3 pictures	41 pictures	7 pictures	83 pictures	10 pictures	124 pictures
5M 2560×1920	4 pictures	49 pictures	8 pictures	95 pictures	11 pictures	137 pictures
4M 2304×1728	5 pictures	62 pictures	10 pictures	124 pictures	15 pictures	178 pictures
3M 2048×1536	6 pictures	77 pictures	13 pictures	153 pictures	19 pictures	223 pictures
2M 1600×1200	10 pictures	124 pictures	17 pictures	206 pictures	26 pictures	301 pictures
1280 1280×960	13 pictures	153 pictures	23 pictures	270 pictures	32 pictures	373 pictures
1024 1024×768	21 pictures	244 pictures	35 pictures	412 pictures	45 pictures	522 pictures
640 640×480	42 pictures	489 pictures	61 pictures	712 pictures	84 pictures	979 pictures

- The image storage capacity is for reference only. The actual image storage capacity may vary depending on the SD memory card and the subject.
- **1280** (1280×960) can only be set for recorded pixels when  mode is set.

Movie

		30fps		15fps		Sound	
		Built-in Memory	128 MB	Built-in Memory	128 MB	Built-in Memory	128 MB
<div style="border: 1px solid black; padding: 2px; display: inline-block;">640</div> 640×480	★★★	10 sec.	1 min. 56 sec.	19 sec.	3 min. 50 sec.	8 min. 22 sec.	1 hr. 36 min. 59 sec.
	★★	13 sec.	2 min. 36 sec.	26 sec.	5 min. 1 sec.		
	★	20 sec.	3 min. 57 sec.	39 sec.	7 min. 40 sec.		
<div style="border: 1px solid black; padding: 2px; display: inline-block;">320</div> 320×240	★★★	16 sec.	3 min. 6 sec.	30 sec.	5 min. 55 sec.		
	★★	21 sec.	4 min. 12 sec.	42 sec.	8 min. 9 sec.		
	★	30 sec.	5 min. 55 sec.	1 min. 1 sec.	11 min. 51 sec.		

The recording time is for reference only. The actual recording time may vary depending on the SD memory card and the subject.

White Balance	Auto, Daylight, Shade, Tungsten Light, Fluorescent Light, Manual
Lens	Focal Length 6.3 mm - 18.9 mm (equivalent to 38 mm - 114 mm in 35 mm format)
	Aperture f/3.3 - f/4
	Lens Composition 11 elements in 9 groups (three aspherical elements)
	Zoom Type Electrically driven
Picture Range	Approx. 16.5 mm × 12.3 mm (screen is filled) (Macro mode)
Digital Zoom	Capture Mode Max. 4× (combines with 3× optical zoom to give zoom magnification equivalent to 12×)
LCD Monitor	2.5-inch low-reflection TFT color LCD monitor (with backlight) with brightness adjustment, approx. 115 kilopixels
Playback Functions	Single-frame, 9-frame index, enlargement (max. 8×, scroll), folder display, calendar display, rotating, sound playback, slideshow, movie playback and editing (saving as still image, dividing, stitching), histogram display, bright/dark portion display, image/sound copying, digital filter, brightness filter, trimming, resizing, framing, red-eye compensation, image recovery
Focus Modes	Autofocus, Macro, Infinity, Pan Focus, Manual Focus

Focus	Type	TTL contrast detection system by sensor 9-point autofocus (multiple/spot/automatic tracking AF changeable)
	Still Picture (from lens front)	Normal : Approx. 0.4 m - ∞ (full zoom range. Telephoto only: approx. 0.5 m - ∞) Macro : Approx. 0.01 m - 0.6 m (Wide-angle) Pan Focus : Approx. 1.5 m - ∞ (Wide-angle), approx. 5.0 m - ∞ (Telephoto) Landscape : ∞ (full zoom range) Manual focus: Approx. 0.01 m - ∞ (Wide-angle), approx. 0.5 m - ∞ (Telephoto) * Continuous AF is available only when automatic tracking AF is set
	Movie (from lens front)	Normal : Approx. 0.4 m - ∞ (full zoom range. Telephoto only: approx. 0.5 m - ∞) Macro : Approx. 0.01 m - 0.6 m (Wide-angle) Pan Focus : Approx. 1.5 m - ∞ (Wide-angle), approx. 5.0 m - ∞ (Telephoto) Landscape : ∞ (full zoom range) Manual focus: Approx. 0.01 m - ∞ (Wide-angle), approx. 0.5 m - ∞ (Telephoto)
	Focus Lock	By half-pressing shutter release button
Exposure Mechanism	AE metering	TTL metering by sensor (multi-segment, center-weighted, spot)
	EV Compensation	±2 EV (can be set in 1/3 EV steps)
Shooting Modes	Green, Program, Night Scene, Movie, Voice Recording, Frame Composite, Landscape, Flower, Portrait, Underwater, Underwater Movie, Surf & Snow, Synchro Sound Record, Sport, Pet, Candlelight, Kids, Soft, Self-portrait, Fireworks, Sunset, Food, Text, Museum, Natural Skin Tone, Report	
Digital Filters	B&W, Sepia, Red, Pink, Purple, Blue, Green, Yellow, Soft, Brightness	
Movie	Continuous Recording Time	Approx. 1 second - until built-in memory or SD Memory Card is full
Shutter	Type	Electronic/mechanical shutter
	Speed	Approx. 1/2000 sec. - 4 sec.
Flash	Type	Auto flash with red-eye reduction function
	Flash Modes	Auto (at low illumination), Flash Off, Flash On, Auto + Red-eye, Flash On + Red-eye, Soft Flash (Slow synchronization is possible only in Night Scene mode)
	Effective Range	Wide-angle: Approx. 0.2 m - 3.6 m (Standard Output Sensitivity: in Auto condition) Telephoto: Approx. 0.5 m - 3 m (Standard Output Sensitivity: in Auto condition)

Drive Modes	Single-frame, Self-timer (approx. 10 sec., approx. 2 sec.), Continuous (Normal, High Speed), Interval Shoot	
Self-timer	Electronic control type, control time: Approx. 10 sec., 2 sec.	
Time Function	World Time	71 cities (28 time zones)
	Clock Mode	Clock display by holding down OK/DISPLAY button while camera is turned off (approx. 10 sec.)
	Alarm	Alarm with simultaneous display of the Clock mode at specified time
Power Supply	Rechargeable lithium-ion battery D-LI8, AC adapter kit (optional)	
Battery Life	Number of Recordable Images 240 pictures	* Recording capacity shows approximate number of shots recorded during CIPA-compliant testing (with LCD monitor on, flash used for 50% of the shots, and 23 degrees centigrade). Actual performance may vary according to operating conditions.
	Playback Time 240 min.	* According to the result of in-house testing. Actual time may differ depending on usage conditions.
	Movie Recording Time 80 min.	
	Sound Recording Time 240 min.	
Max. Charging Time	Approx. 100 min.	
In/Out Port	PC/AV terminal, DC input terminal	
Video Output Format	NTSC/PAL (monaural)	
PictBridge	Printer	PictBridge-compatible printer
	Print Modes	Print One, Print All, DPOF AUTOPRINT
	Paper Size	Card, L, 2L, Postcard, 100 mm×150 mm, 4"×6", 8"×10", Letter, 11"×17", A4, A3, printer setting
	Paper Type	★★★, ★★, ★, printer setting
	Quality	★★★, ★★, ★, printer setting
	Border Status	With/without, printer setting
Waterproof and Dustproof Function	Complies with JIS Class 8 waterproof performance and Class 5 dustproof performance (IP58) Continuous underwater picture-taking possible for 30 min. at depth of 1.5 m.	
Size	106.5 (W) × 54.5 (H) × 23 (D) mm (excluding operating or protruding parts)	
Weight	140 g (excluding battery and SD Memory Card)	
Weight When Shooting	155 g (including battery and SD Memory Card)	
Accessories	Rechargeable lithium-ion battery, battery charger, AC plug cord, USB cable, AV cable, software (CD-ROM), strap, operating manual	

WARRANTY POLICY

All PENTAX cameras purchased through authorized bona fide photographic distribution channels are guaranteed against defects of material or workmanship for a period of twelve months from date of purchase. Service will be rendered, and defective parts will be replaced without cost to you within that period, provided the equipment does not show evidence of impact, sand or liquid damage, mishandling, tampering, battery or chemical corrosion, operation contrary to operating instructions, or modification by an unauthorized repair shop. The manufacturer or its authorized representatives shall not be liable for any repair or alterations except those made with its written consent and shall not be liable for damages from delay or loss of use or from other indirect or consequential damages of any kind, whether caused by defective material or workmanship or otherwise; and it is expressly agreed that the liability of the manufacturer or its representatives under all guarantees or warranties, whether expressed or implied, is strictly limited to the replacement of parts as hereinbefore provided. No refunds will be made on repairs by non-authorized PENTAX service facilities.

Procedure During 12-month Warranty Period

Any PENTAX which proves defective during the 12-month warranty period should be returned to the dealer from whom you purchased the equipment or to the manufacturer. If there is no representative of the manufacturer in your country, send the equipment to the manufacturer, with postage prepaid. In this case, it will take a considerable length of time before the equipment can be returned to you owing to the complicated customs procedures required. If the equipment is covered by warranty, repairs will be made and parts replaced free of charge, and the equipment will be returned to you upon completion of servicing. If the equipment is not covered by warranty, regular charges of the manufacturer or of its representatives will apply. Shipping charges are to be borne by the owner. If your PENTAX was purchased outside of the country where you wish to have it serviced during the warranty period, regular handling and servicing fees may be charged by the manufacturer's representatives in that country. Notwithstanding this, your PENTAX returned to the manufacturer will be serviced free of charge according to this procedure and warranty policy. In any case, however, shipping charges and customs clearance fees to be borne by the sender. To prove the date of your purchase when required, please keep the receipt or bills covering the purchase of your equipment for at least a year. Before sending your equipment for servicing, please make sure that you are sending it to the manufacturer's authorized representatives or their approved repair shops, unless you are sending it directly to the manufacturer. Always obtain a quotation for the service charge, and only after you accept the quoted service charge, instruct the service station to proceed with the servicing.

- This warranty policy does not affect the customer's statutory rights.
- The local warranty policies available from PENTAX distributors in some countries can supersede this warranty policy. Therefore, we recommend that you review the warranty card supplied with your product at the time of purchase, or contact the PENTAX distributor in your country for more information and to receive a copy of the warranty policy.



The CE Mark is a Directive conformity mark of the European Union.

For customers in USA

STATEMENT OF FCC COMPLIANCE

This device complies with Part 15 of the FCC Rules. Operation is subject to the following two conditions: (1) This device may not cause harmful interference, and (2) this device must accept any interference received, including interference that may cause undesired operation.

Changes or modifications not approved by the party responsible for compliance could void the user's authority to operate the equipment.

This equipment has been tested and found to comply with the limits for a Class B digital device, pursuant to part 15 of the FCC Rules.

These limits are designed to provide reasonable protection against harmful interference in a residential installation. This equipment generates, uses and can radiate frequency energy and, if not installed and used in accordance with the instructions, may cause harmful interference to radio communications. However, there is no guarantee that interference will not occur in a particular installation.

If this equipment does cause harmful interference to radio or television reception, which can be determined by turning the equipment off and on, the user is encouraged to try to correct the interference by one or more of the following measures:

- Reorient or relocate the receiving antenna.
 - Increase the separation between the equipment and receiver.
 - Connect the equipment into an outlet on a circuit different from that to which the receiver is connected.
- * Consult the dealer or an experienced radio/TV technician for help.

For customers in Canada

This Class B digital apparatus meets all requirements of the Canadian Interference - Causing Equipment Regulations.

Pour les utilisateurs au Canada

Cet appareil numérique de la classe B respecte toutes les exigences du Règlement sur le matériel brouilleur du Canada.

Declaration of Conformity
According to 47CFR, Parts 2 and 15 for
Class B Personal Computers and Peripherals

We: PENTAX Imaging Company
A Division of PENTAX of America, Inc.

Located at: 600 12th Street, Suite 300
Golden, Colorado 80401 U.S.A.
Phone: 303-799-8000 FAX: 303-790-1131

Declare under sole responsibility that the product identified herein complies with 47CFR Parts 2 and 15 of the FCC rules as a Class B digital device. Each product marketed is identical to the representative unit tested and found to be compliant with the standards. Records maintained continue to reflect the equipment being produced can be expected to be within the variation accepted, due to quantity production and testing on the statistical basis as required by 47CFR §2.909. Operation is subject to the following two conditions: (1) This device may not cause harmful interference, and (2) This device must accept any interference received, including interference that may cause undesired operation. The above named party is responsible for ensuring that the equipment complies with the standards of 47CFR §15.101 to §15.109.

Product Name: PENTAX Digital Still Camera

Model Number: Optio W10

Contact person: Customer Service Manager

Date and Place: February, 2006, Colorado

Information on disposal for users



1. In the European Union

If your product is marked with this symbol, it means that used electrical/electronic products should not be mixed with general household waste. There exists a separate collection system for these products.

Used electric/electronic equipment must be treated separately and in accordance with legislation that requires proper treatment, recovery and recycling of these products. Following the implementation by member states, private households within the EU states may return their used electrical/electronic equipments to designated collection facilities free of charge*. In some countries your local retailer may also take back your old product free of charge if you purchase a similar new one.

*Please contact your local authority for further details.

By disposing of this product correctly you will help ensure that the waste undergoes the necessary treatment, recovery and recycling and thus prevent potential negative effects on the environment and human health which could otherwise arise due to inappropriate waste handling.

2. In other countries outside the EU

If you wish to discard this product, please contact your local authorities and ask for the correct method of disposal.

For Switzerland: Used electrical/electronic equipment can be returned free of charge to the dealer, even when you don't purchase a new product. Further collection facilities are listed on the home page of www.swico.ch or www.sens.ch.

Symbols

[Rec.Mode] menu	51
mode	10, 113
button	44, 47
mode	10, 113
[Setting] menu	52
Green Mode	64
Green Button ...	44, 46, 58
Delete	43, 123
Tele	80
Wide	80
Magnify	116
Nine-image display	114
Self-timer	76
Continuous Shooting	77
Program	54, 63
Night Scene	54, 66
Movie	54
Voice Recording ...	54, 153
Frame Composite ..	54, 67
Landscape	54
Flower	54
Portrait	55
Underwater	55, 72
Underwater Movie	55
Surf & Snow	55
Synchro Sound	
Record	55, 74
Sport	55
Pet	56, 70
Candlelight	56, 66
Kids	56
SOFT Soft	56
Self-portrait	56
Fireworks	56, 66
Sunset	57
Food	57

Text	57, 75
Museum	57
Natural Skin Tone	57
Report	57

A

AC adapter	27
Adapter plug	25
Adding sound (Voice Memo)	156
AE metering	94
Alarm	163
Auto + Red-eye 	87
Auto AWB	92
Auto Power Off	173
Auto 	87
Autofocus conditions	97
AV equipment	122

B



B&W	110, 136
Basic mode	64
Battery level indicator ..	24
Bright portions	19
Brightness Filter	137

C





Calendar display	115
Calling up menus	58
Camera shake	80, 83
Capture Mode Palette	53
Center-weighted metering 	94
Changing volume	155, 161
Charging a battery	22, 25
Checking the memory card	34
Clock mode	178

Color Mode	110
Computer	169
Connecting to a printer	148
Continuous Shooting 	77
Contrast	102
Copy	134

D

Dark portions	19
Date and time	38, 159
Daylight 	92
Daylight saving time	38
Default setting	36, 180
Delete 	43, 123
Deleting sounds	124
Digital Filter	136
Digital Zoom	81
Dividing movies	143
DPOF printing	152
DPOF settings	145

F

File #	103
Flash Off 	87
Flash On + Red-eye 	87
Flash On 	87
Fluores. Light 	92
Focus Limiter	98
Focus Mode	85
Focusing	85
Focusing Area	97
Folder display	115
Format	158
Four-way controller	45, 47
Frame Composite	139
Frame Rate	32, 109



G

Green Button 	44, 46, 58
Green Mode 	64

H

High Speed Continuous Shooting 	77
Histogram	84
Hometown	38





I

Infinity 	85
Installing a battery	23
Instant Review	41, 99
Interval	78
Interval Shoot 	78

L

Language	36, 167
LCD monitor brightness ...	171

M









Macro 	85
Magnify 	116
Manual Focus MF	85
Manual 	92
Memory	103
MENU button	45, 47
Menu order	175
Movie anti-shake	111
Multi-segment metering  ..	94

N

Nine-image display 	114
NTSC	170
Number of pixels	89
Number of Recordable Images	32
Number of Shot	78

O

OK/DISPLAY button ...	45, 47
Optional accessory	185

P	
PAL	170
Pan Focus PF	85
Photo processing lab	145
PictBridge	148
Playback	42, 113, 121, 155, 157
Playback Mode Palette	60
Playback Only Mode	35
Playing back movies	121
Playing back sounds	155
Power Saving	172
Power saving function	172
Power switch	34, 44, 46
Press fully (shutter release button)	41
Press halfway (shutter release button)	41
Printing	148
Protect 	129
Q	
Quality Level	31, 91
Quick Zoom	117
R	
Recorded Pixels	31, 32, 89, 107
Recording movies	105
Recording sounds	153
Recovering images	128
Red-eye Compensation ...	138
Red-eye reduction   ..	87, 88
Resetting settings	176
Resize	131
Rotating	43
S	
Saturation	101
Saving as still picture (movie)	142
Saving by date	168
Saving settings	103
SD Memory Card	28
Select time	166
Self-timer 	76
Sensitivity	96
Sepia	110, 136
Setting the exposure	82
Shade 	92
Sharpness	100
Shooting information ..	83, 118
Shooting Mode	53
Shooting with sound	74
Shutter release button	41, 44, 46
Slideshow	119
Soft (digital filter)	136
Soft Flash ^{SOFT} 	87
Sound settings	161
Sound types	161
Spot AE metering 	94
Standard AF	85
Start Time	78
Start-up screen	174
Stitching movies	144
Strap	21
T	
Trimming	133
Tungsten Light 	92
TV	122
U	
Underwater shooting	72
USB connection mode	169
V	
Video output format	170
Viewing a guide	62
Voice Memo	156

W

Waterproof and dustproof	5, 72
White Balance	92
World Time	165

Z

Zoom button	44, 46
Zoom ▲▲▲▲	80

Memo

Memo

Memo

PENTAX Corporation	2-36-9, Maeno-cho, Itabashi-ku, Tokyo 174-8639, JAPAN (http://www.pentax.co.jp/)
PENTAX Europe GmbH (European Headquarters)	Julius-Vosseler-Strasse, 104, 22527 Hamburg, GERMANY (HQ - http://www.pentaxeurope.com) (Germany - http://www.pentax.de)
PENTAX U.K. Limited	PENTAX House, Heron Drive, Langley, Slough, Berks SL3 8PN, U.K. (http://www.pentax.co.uk)
PENTAX France S.A.S.	112 Quai de Bezons, B.P. 204, 95106 Argenteuil Cedex, France (http://www.pentax.fr)
PENTAX Benelux B.V.	(for Netherlands) Spinveld 25, 4815 HR Breda, NETHERLANDS (http://www.pentax.nl) (for Belgium & Luxembourg) Weiveldlaan 3-5, 1930 Zaventem, BELGIUM (http://www.pentax.be)
PENTAX (Schweiz) AG	Widenholzstrasse 1 Postfach 367 8305 Dietlikon, SWITZERLAND (http://www.pentax.ch)
PENTAX Scandinavia AB	P.O. Box 650, 75127 Uppsala, SWEDEN (http://www.pentax.se)
PENTAX Imaging Company A Division of PENTAX of America, Inc.	(Headquarters) 600 12th Street, Suite 300 Golden, Colorado 80401, U.S.A. (PENTAX Service Department) 12000 Zuni Street, Suite 100B Westminster, Colorado 80234, U.S.A. (http://www.pentaximaging.com)
PENTAX Canada Inc.	1770 Argentia Road Mississauga, Ontario L5N 3S7, CANADA (http://www.pentax.ca)



<http://www.pentax.co.jp/english>

- Specifications and external dimensions are subject to change without notice.