

PENTAX



Digital Camera

Optio W90

Operating Manual



To ensure the best performance from your camera, please read the Operating Manual before using the camera.

Thank you for purchasing this PENTAX Digital Camera. Please read this manual before using the camera in order to get the most out of all the features and functions. Keep this manual safe, as it can be a valuable tool in helping you to understand all the camera's capabilities.

Regarding copyrights

Images taken using the PENTAX Digital Camera that are for anything other than personal enjoyment cannot be used without permission according to the rights as specified in the Copyright Act. Please take care, as there are cases where limitations are placed on taking pictures even for personal enjoyment during demonstrations, performances or of items on display. Images taken with the purpose of obtaining copyrights also cannot be used outside the scope of use of the copyright as laid out in the Copyright Act, and care should be taken here also.

Regarding trademarks

- PENTAX and Optio are trademarks of HOYA CORPORATION.
- SDHC logo () is a trademark of SD-3C, LLC.
- Microsoft and Windows are registered trademarks of Microsoft Corporation in the United States and other countries. Windows Vista is either a registered trademark or trademark of Microsoft Corporation in the United States and/or other countries.
- Macintosh and Mac OS are trademarks of Apple Inc., registered in the U.S. and other countries.
- ArcSoft[®], and its logo are either the registered trademark or trademark of ArcSoft Inc. in the United States and/or other countries.
- HDMI, the HDMI Logo and High-Definition Multimedia Interface are trademarks or registered trademarks of HDMI Licensing LLC.
- Eye-Fi, the Eye-Fi *connected* are trademarks of Eye-Fi, Inc.
- This product supports PRINT Image Matching III. PRINT Image Matching enabled digital still cameras, printers and software help photographers to produce images more faithful to their intentions. Some functions are not available on printers that are not PRINT Image Matching III compliant. Copyright 2001 Seiko Epson Corporation. All Rights Reserved. PRINT Image Matching is a trademark of Seiko Epson Corporation. The PRINT Image Matching logo is a trademark of Seiko Epson Corporation.
- All other brands or product names are trademarks or registered trademarks of their respective companies.

Regarding Product Registration

In order to better serve you, we request that you complete the product registration, which can be found on the CD-ROM supplied with the camera or on the PENTAX website. Thank you for your cooperation. Refer to "Product Registration on the Internet" (p.266) for more information.

To users of this camera

- Do not use or store this device in the vicinity of equipment that generates strong electromagnetic radiation or magnetic fields.
Strong static charges or the magnetic fields produced by equipment such as radio transmitters could interfere with the monitor, damage the stored data, or affect the product's internal circuitry and cause camera misoperation.
- The liquid crystal panel used in the display is manufactured using extremely high precision technology. Although the level of functioning pixels is 99.99% or better, you should be aware that 0.01% or fewer of the pixels may not illuminate or may illuminate when they should not. However, this has no effect on the recorded image.
- A band of light may appear on the display if the camera is aimed at a bright subject. This is known as a smear, but it is not a malfunction.
- There is a possibility that the illustrations and the display screen in this manual are different from the actual product.
- In this manual, both an SD Memory Card and an SDHC Memory Card are referred to as SD Memory Cards hereafter.
- In this manual, the generic term "computer(s)" refers to either a Windows PC or a Macintosh hereafter.
- In this manual, the term "battery" refers to any type of batteries used for this camera and accessories.

Using Your Camera Safely

We have paid close attention to the safety of this product. When using this product, we request your special attention regarding items marked with the following symbols.



Warning This symbol indicates that violating this item could cause serious personal injuries.



Caution This symbol indicates that violating this item could cause minor or medium personal injuries, or loss of property.

About the Camera

Warning

- Do not attempt to take the camera apart or modify the camera. High voltages are present within the camera, and there is a danger of electric shock if the camera is taken apart.
- If the inside of the camera should become exposed as a result of, for example, the camera being dropped, please do not under any circumstances touch such exposed portions, as there is a danger of receiving an electric shock.
- Wrapping the strap of the camera around your neck is also dangerous. Please take care that small children do not hang the strap around their necks.
- If any irregularities occur during use, such as smoke or a strange odor, stop use immediately, remove the battery or the AC adapter, and contact your nearest PENTAX Service Center. Continuing to use the product can cause a fire or electric shock.

Caution

- Do not place your finger on the flash when it is discharging as there is a risk of burns.
- Do not discharge the flash while it is touching your clothing as there is a risk of discoloring.
- Some portions of the camera heat up during use, so please take care, as there is a risk of low temperature burns if such portions are held for long periods of time.
- Should the LCD be damaged, be careful of glass fragments. Also, be careful not to allow the liquid crystal to get on your skin, in your eyes, or in your mouth.
- Depending on your individual factors or physical condition, the use of the camera may cause itching, rashes or blisters. In case of any abnormality, stop using the camera and get medical attention immediately.

About the Battery Charger and the AC Adapter

Warning

- Always use the battery charger and AC adapter exclusively developed for this product, with the specified power and voltage. Using a battery charger or AC adapter not exclusive to this product, or using the exclusive battery charger or AC adapter with an unspecified power or voltage can cause a fire, electric shock, or camera breakdown. The specified voltage is 100-240V AC.
- Do not disassemble or modify the product. This can cause a fire or electric shock.
- If the generation of smoke or strange odor from the product or other abnormality occurs, immediately discontinue its use and consult a PENTAX Service Center. Continuing to use the product can cause a fire or electric shock.
- If water should happen to get inside the product, consult a PENTAX Service Center. Continuing to use the product can cause a fire or electric shock.
- If a thunder storm should occur while using the battery charger or AC adapter, unplug the AC plug cord and discontinue use. Continuing to use the product can cause damage to the equipment, fire, or electric shock.
- Wipe off the plug of the AC plug cord if it becomes covered with dust. Dust on the plug may cause a fire.

Caution

- Do not place heavy objects on the AC plug cord, allow heavy objects to drop onto it or allow the AC plug cord to become damaged due to excessive bending. If the AC plug cord becomes damaged, consult a PENTAX Service Center.
- Do not short or touch the output terminals of the product while it is still plugged in.
- Do not plug in the AC plug cord with wet hands. This can cause an electric shock.
- Do not subject the product to strong impacts or allow it to drop onto a hard surface. This can cause a malfunction.
- Do not use the battery charger to charge a battery other than a rechargeable lithium-ion battery D-LI88. This can cause overheating, explosion, or battery charger failure.

- To reduce the risk of hazards, use only a CSA/UL certified power supply cord set, cord is Type SPT-2 or heavier, minimum NO.18 AWG copper, one end with a molded-on male attachment plug cap (with a specified NEMA configuration), and the other is provided with a molded-on female connector body (with a specified IEC nonindustrial type configuration) or the equivalent.

About the Battery

Warning

- Be sure to store the battery out of the reach of small children. Placing it in their mouths may cause an electric shock.
- If any leakage from the battery should come in contact with your eyes, it may cause a loss of sight. Flush your eyes with clean water and get medical attention immediately. Do not rub them.

Caution

- Only use the specified battery with this camera. Use of other batteries may cause an explosion or fire.
- Do not disassemble the battery. Disassembling the battery may cause an explosion or leakage.
- Remove the battery from the camera immediately if it becomes hot or begins to smoke. Be careful not to burn yourself during removal.
- Keep wires, hairpins, and other metal objects away from the + and - contacts of the battery.
- Do not short the battery or dispose of the battery in fire. This can cause an explosion or fire.
- If any leakage from the battery should come in contact with skin or clothes, it may cause irritation to the skin. Wash the affected areas thoroughly with water.
- Precautions for D-LI88 Battery Usage:
 - BATTERY MAY EXPLODE OR FIRE IF MISTREATED.
 - DO NOT DISASSEMBLE OR DISPOSE OF IN FIRE.
 - DO NOT CHARGE EXCEPT SPECIFIED CHARGING CONDITION.
 - DO NOT HEAT ABOVE 140°F / 60°C, OR SHORT CIRCUIT.
 - DO NOT CRUSH OR MODIFY.

Keep the Camera and Accessories Away from Children

Warning

- Always keep the camera and accessories out of the reach of young children and infants.
 1. The camera could fall unexpectedly and cause an injury.
 2. Putting the strap around a child's neck could cause asphyxiation.
 3. Children may swallow small objects (such as the battery, SD memory card). If this happens contact a doctor immediately.

Care to be Taken During Handling

Before Starting Use

- When traveling, take the Worldwide Service Network listing that is included in the package. This will be useful if you experience problems abroad.
- When the camera has not been used for a long time, confirm that it is still working properly, particularly prior to taking important pictures (such as at a wedding or when traveling). Contents of the recording cannot be guaranteed if recording, playback or transferring your data to a computer, etc. is not possible due to a malfunction of your camera or recording media (SD Memory Card), etc.
- The lens on this camera is not interchangeable. The lens is not removable.

About the Battery and Battery Charger

- Storing the battery fully charged may decrease the battery performance. Avoid storing it especially in high temperatures.
If the battery is left inserted and the camera is not used for a long time, the battery will over-discharge and shorten the battery's service life.
- Charging the battery a day before use or on the day of use is recommended.
- The AC plug cord supplied with the camera is for exclusive use with the battery charger D-BC88. Do not use it with any other equipment.

Cautions when Carrying and Using the Camera

- Hot and humid places should be avoided. Particular care should be taken regarding vehicles, which can become very hot inside.
- Ensure that the camera is not subjected to substantial vibrations, shocks, or pressure as this may cause damage, malfunction, or a loss in waterproof performance. Place the camera on a cushion for protection when the camera is subjected to the vibrations of a motorbike, car, ship, etc. If the camera is subjected to substantial vibrations, shocks, or pressure, take your camera to your nearest PENTAX Service Center and have it checked.
- The temperature range in which the camera can be used is -10°C to 40°C (14°F to 104°F).
- The liquid crystal display will become black at high temperatures but will return to normal at normal temperatures.
- The response speed of the liquid crystal display becomes slow at low temperatures. This is due to the properties of the liquid crystal and is not a malfunction.
- If the camera is subjected to rapid temperature changes, condensation may form on the inside and outside of the camera. Therefore put the camera in a bag or plastic bag and take the camera out when the difference in temperature has subsided.
- Avoid contact with garbage, mud, sand, dust, water, toxic gases, or salts. These could cause the camera to breakdown. Wipe the camera to dry off any rain or water drops.
- Please do not press forcefully on the display. This could cause it to break or malfunction.
- Be careful not to sit down with the camera in your back pocket as this may damage the exterior of the camera or the display.
- When using a tripod with the camera, be careful not to overtighten the screw in the tripod socket on the camera.

About Repairs

- Do not clean the product with organic solvents such as thinner, alcohol or benzene.
- Use a lens brush to remove dust accumulated on the lens. Never use a spray blower for cleaning as it may damage the lens.

About Storage

- Avoid storing the camera where pesticides and chemicals are handled. Remove the camera from its case and store it in a well-ventilated place to prevent the camera from becoming moldy during storage.

Others

- Periodic checks are recommended every 1 to 2 years in order to maintain high performance.
- Refer to “Precautions When Using an SD Memory Card” (p.47) regarding the SD Memory Card.
- Please note that deleting images or sound files, or formatting the SD Memory Cards or the built-in memory does not completely erase the original data. Deleted files can sometimes be recovered using commercially available software. It is the user’s responsibility to ensure the privacy of such data.

Regarding Waterproof, Dustproof, and Shockproof Design

- This camera is provided with a waterproof/dustproof design complying with JIS waterproof grade 8 and JIS dustproof grade 6 (equivalent to IP68).
- The camera satisfies the PENTAX drop test (1.2 m height onto a 5 cm thick plywood surface) complying with MIL-Standard 810F Method 516.5-Shock testing.
- The camera satisfies the PENTAX test for the waterproof, dustproof, and shockproof performance, but this does not guarantee it will remain free of trouble or damages.
- Waterproof performance is not guaranteed if the camera is exposed to impact such as being dropped or hit.

Precautions Before Using the Camera in the Water

Check the Following Before Going Near the Water

- Make sure that there are no cracks or scratches on the rubber seal of the battery/card and terminal covers.

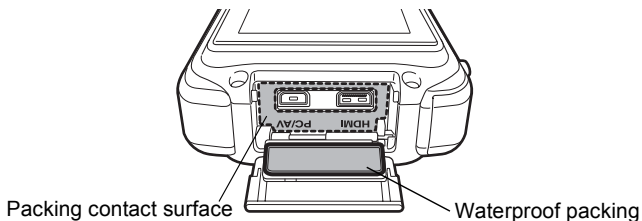
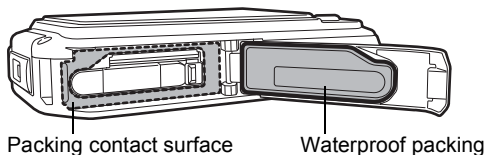

- Make sure there are no foreign objects (dust, sand, hair, lint or liquid) on the rubber seals or the surface they contact before closing the battery/card and terminal covers. Wipe off any foreign objects with a clean lint-free cloth.

- Close the battery/card and terminal covers properly until they click. Otherwise water may get in and damage the camera.

Be Careful Near the Water

- Avoid opening the battery/card and terminal covers when near the waterside or with wet hands. Wait until the camera is completely dry before changing the battery or the SD Memory Card. Avoid changing the battery or card where the camera is likely to get wet or dirty, and make sure that your hands are dry.
- The camera will sink if dropped in water, so be sure to attach the strap and slip the strap over your wrist when using the camera in or near water.
- To enhance the waterproof performance of the camera, the front of the lens is protected by glass. As any dirt or water on the glass will affect the quality of pictures taken, the glass should be kept clean at all times.

Precautions When Using the Camera in the Water

- Do not use the camera deeper than 6 meters underwater. Do not use the camera underwater for more than 120 minutes consecutively.
- Do not open the battery/card and terminal covers underwater.
- Do not use in hot water or in a hot spring.
- Do not apply excessive force to the camera, for example diving into water with it. Doing so may compromise the waterproof performance of the camera or cause the covers to open.
- Leaving the camera on the sand at the beach may cause the camera to exceed its operating temperature or cause the speaker or microphone to become blocked with sand.
- Avoid subjecting the camera to substantial vibrations, shocks, or pressure as this may cause a loss in waterproof performance. If the camera is subjected to substantial vibrations, shocks or pressure, take your camera to your nearest PENTAX Service Center and have it checked.
- Avoid getting sunscreen or sun oil on the camera as it may cause discoloration of the surface. If any oil gets on the camera, wash it off immediately with warm water.
- Sudden and extreme changes in temperature may cause condensation to form in and on the camera. Keep the camera in a bag or case to reduce the difference in temperature.



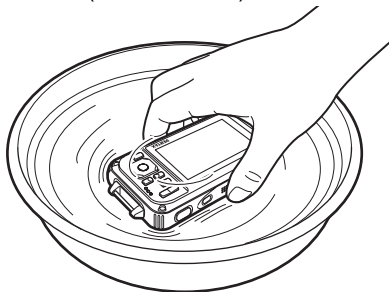

Precautions After Using the Camera in the Water

- Do not open the battery/card cover or terminal cover if the camera is wet. Wipe off any water with a clean lint-free cloth.
- The inside surface of the covers may get wet when they are opened. Wipe off any water that is on the cover.
- Wiping off the camera while there is sand or dust on it may scratch the surface of the camera. Make sure that the battery/card cover and terminal cover are firmly closed before washing the camera in tap water. After washing the camera, dry it with a soft cloth.
- Wipe off any dirt or sand on the waterproof packing or the packing contact surface. The camera's waterproof performance may be compromised by loose packing or cracks or dents in the packing or packing contact surface. If there is any such damage, contact your nearest PENTAX Service Center.
- If the camera is very dirty or after it has been used in the sea, make sure that it is turned off and the battery/card and terminal covers are firmly closed before rinsing it under running tap water or leaving it in a bowl of clean water for a short time (2 or 3 minutes).



- Avoid cleaning with agents such as soapy water, mild detergents, or alcohol as this may compromise the waterproof performance of the camera.
- To maintain the waterproof performance of the camera, you are recommended to change the waterproof packing once a year. Contact your nearest PENTAX Service Center regarding changing the packing. (A charge will be made.)
- The camera's accessories are not waterproof.

Contents

Using Your Camera Safely	1
Care to be Taken During Handling	5
Regarding Waterproof, Dustproof, and Shockproof Design	8
Precautions Before Using the Camera in the Water	8
Precautions When Using the Camera in the Water	9
Precautions After Using the Camera in the Water	10
Contents	11
Composition of the Operating Manual	17
Camera Features	18
Checking the Contents of the Package	22
Names of Parts	23
Names of Operating Parts	24
Monitor Indications	24
Getting Started	35
<hr/>	
Attaching the Strap	36
Attaching the Strap	36
Attaching the Carabiner Strap	36
Powering the Camera	38
Charging the Battery	38
Installing the Battery	39
Using the AC Adapter	43
Installing the SD Memory Card	45
Number of Images Recordable on an SD Memory Card	48
Turning the Camera On and Off	49
Starting-up in the Playback Mode	50
Initial Settings	51
Setting the Display Language	51
Setting the Date and Time	55
Common Operations	59
<hr/>	
Understanding the Button Functions	60
 Mode	60
 Mode	62
Switching Between  Mode and  Mode	64
Setting the Camera Functions	65
Operating the Menus	65
Menu List	69

Taking Still Pictures	74
Taking Pictures	74
Setting the Shooting Mode	78
Using the Face Detection Function	81
Taking Pictures Automatically (Auto Picture Mode)	83
Setting the Functions (Program Mode).....	85
Taking Pictures in the Basic Mode (Green Mode).....	86
Using the Zoom	87
Taking Pictures of Dark Scenes (Night Scene, Night Scene Portrait, Digital SR, Fireworks, and Candlelight Modes).....	90
Taking Pictures of People (Portrait Mode).....	91
Taking Pictures of Children (Kids Mode)	93
Taking Pictures of Your Pet (Pet Mode)	94
Taking Pictures of Sports and Leisure Activities (Surf & Snow/ Sport Mode)	97
Taking Pictures of Text (Text Mode)	98
Taking Pictures in Digital Microscope Mode.....	99
Framing Your Pictures (Frame Composite Mode).....	101
Using the Self-timer	103
Taking a Series of Pictures (Continuous Shooting/ Burst Shooting)	104
Taking Pictures Using the Remote Control Unit (Optional)	106
Taking Pictures at a Set Interval (Interval Shoot).....	108
Taking Pictures with Automatic Exposure Adjustment (Auto Bracket)	110
Using the Digital Wide Function (Digital Wide Mode).....	111
Taking Panoramic Pictures (Digital Panorama Mode).....	114
Setting the Shooting Functions	117
Selecting the Flash Mode	117
Selecting the Focus Mode	119
Setting the Image Tone	124
Selecting the Number of Recorded Pixels	125
Selecting the Quality Level of Still Pictures	127
Adjusting the White Balance.....	128
Setting the AE Metering.....	130
Setting the Sensitivity	131
Setting ISO Correction in AUTO.....	132
Setting the Exposure (EV Compensation).....	133
Correcting the Brightness (D-Range Setting).....	134
Setting Pixel Track SR.....	135
Setting the Interval Shooting	136
Setting Blink Detection	138

Setting the Instant Review	139
Setting the Green Button	139
Setting the Image Sharpness (Sharpness).....	143
Setting the Saturation/Tone Adjustment.....	144
Setting the Image Contrast (Contrast).....	145
Setting the Date Imprint Function	145
Setting the Macro Light.....	146
Taking Pictures Underwater	148
Taking Underwater Pictures (Underwater Mode/Underwater Movie Mode)	148
Recording Movies	150
Recording Movies.....	150
Selecting the Number of Recorded Pixels and Frame Rate for Movies.....	152
Setting the Movie SR (Movie Shake Reduction) Function.....	153
Recording a Movie from Pictures Taken at a Set Interval (Interval Movie)	154
Saving the Settings (Memory)	158
Playing Back and Deleting Images	161
<hr/>	
Playing Back Images	162
Playing Back Still Pictures	162
Playing Back a Movie	163
Multi-Image Display	164
Using the Playback Function	166
Slideshow	169
Rotating the Image	172
Zoom Playback.....	173
Zoom In on the Subject's Face Automatically (Face Close-up Playback)	174
Deleting Images and Sound Files.....	176
Deleting a Single Image/Sound File	176
Deleting Selected Images and Sound Files.....	178
Deleting All Images and Sound Files.....	179
Recovering Deleted Images	180
Protecting Images and Sound Files from Deletion (Protect)	181
Connecting the Camera to AV Equipment.....	184
Connecting the Camera to a Video IN Jack	184
Connecting the Camera to an HDMI Terminal	186

Editing Images	190
Changing the Image Size (Resize)	190
Cropping Images	191
Processing Images So That Faces Look Smaller	192
Using the Digital Filters	194
Using the Ink Rubbing Filter	199
Creating a Collage Image	200
Red-eye Compensation	205
Adding a Frame (Frame Composite)	206
Overlaying Your Original Frame on an Image	209
Editing Movies	214
Copying Images and Sound Files	217
Setting the Printing Service (DPOF)	219
Printing a Single Image	219
Printing All Images	221
Recording and Playing Back Sound	223
Recording Sound (Voice Recording Mode)	224
Setting Voice Recording	224
Recording Sounds	225
Playing Back Sound	226
Adding a Voice Memo to Images	228
Recording a Voice Memo	228
Playing Back a Voice Memo	229
Settings	231
Camera Settings	232
Formatting an SD Memory Card	232
Changing the Sound Settings	233
Changing the Date and Time	235
Setting the Alarm	237
Setting the World Time	239
Setting the Text Size on the Menu	242
Changing the Display Language	243
Changing the System for Naming Folders	244
Changing the Video Output Format	246
Selecting the HDMI Output Format	247
Setting the Eye-Fi Communication	249
Adjusting the Brightness of the Display	250
Using the Power Saving Function	251

Setting Auto Power Off	252
Setting the Quick Zoom Function	253
Setting the Guide Display	254
Perform Pixel Mapping	255
Registering the Subscreen Image (Subscreen Input).....	256
Changing the Start-up Screen	257
Resetting to Default Settings (Reset)	258
Displaying the Clock Mode	259
Connecting to a Computer	261
Setting Up Your Computer	262
Provided Software	262
System Requirements	263
Installing the Software	264
Setting the USB Connection Mode	267
Connecting to a Windows PC	269
Connecting the Camera and Your Windows PC	269
Transferring Images	270
Disconnecting the Camera from Your Windows PC	273
Starting "Medialmpression 2.0 for PENTAX"	274
Viewing Images	277
Details on How to Use "Medialmpression 2.0 for PENTAX"	278
Connecting to a Macintosh	279
Connecting the Camera and Your Macintosh.....	279
Transferring Images	280
Disconnecting the Camera from Your Macintosh	281
Starting "Medialmpression 2.0 for PENTAX"	282
Viewing Images	284
Details on How to Use "Medialmpression 2.0 for PENTAX"	284
Transferring Images Using an Eye-Fi Card	285
Appendix	287
Functions Available for Each Shooting Mode	288
Messages	291
Troubleshooting	293
Default Settings	295
List of World Time Cities	300
Optional Accessories	301
Main Specifications	302
Warranty Policy	307
Index	312

In this manual, the method for operating the four-way controller is shown in illustrations, such as in the one below.

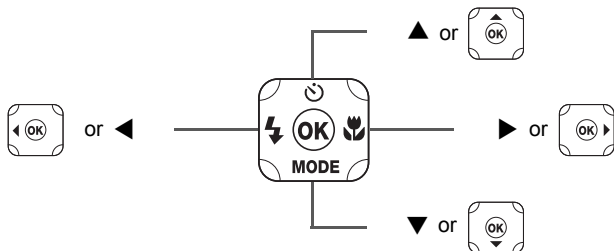

The meanings of the symbols used in this Operating Manual are explained below.

	Indicates the reference page number for an explanation of the related operation.
	Indicates information that is useful to know.
	Indicates precautions to be taken when operating the camera.
Mode	This is the mode for taking still pictures and movies. In this manual, “Still Picture Capture Mode” is the mode for taking still pictures while “ mode” is the mode for taking movies.
Mode	This is the mode for viewing still pictures and playing back movies and sound files.

Composition of the Operating Manual

This Operating Manual contains the following chapters.

1 Getting Started

This chapter explains what you need to do after purchasing the camera before you start taking pictures. Be sure to read it and follow the instructions.

2 Common Operations

This chapter explains common operations such as the functions of the buttons and how to use the menus. For more details, refer to the respective chapters below.

3 Taking Pictures

This chapter explains the various ways of capturing images and how to set the relevant functions.

4 Playing Back and Deleting Images

This chapter explains how to view still pictures and movies on the camera or on a TV and how to delete images, sound files, and movies from the camera.

5 Editing and Printing Images

This chapter explains the various ways of printing still pictures and how to edit images with the camera.

6 Recording and Playing Back Sound

This chapter explains how to record sound files or add sound (a voice memo) to an image and how to play back sound files.

7 Settings

This chapter explains how to set camera-related functions.

8 Connecting to a Computer

This chapter explains how to connect the camera to a computer, and includes installation instructions and a general overview of the provided software.

9 Appendix

This chapter deals with troubleshooting and lists the optional accessories.

1

2

3

4

5

6

7

8

9

Camera Features

In addition to basic picture-taking, the Optio W90 has a variety of shooting modes to suit different situations. This section describes how to make the most of the key features of your camera. Together with the explanations of camera operations, it will enable you to enjoy your camera to the fullest.

Suitable for Outdoor Activities

The Optio W90 is both waterproof and dustproof and has a tough body. You need not worry about sprays of water while fishing or unexpected rain or dust while trekking.



Functions that expand photo opportunities to the sea, the hills, and the rivers

- Waterproof at a depth of 6 meters (19.7 ft.)
- Take pictures underwater for two hours
- Covers can be locked*1
- Shockproof performance*2
- Water repellent coating on the lens cover glass.

*1 This camera has locks for the battery/card and terminal covers. The battery compartment and the card and terminal compartment are not waterproof or dustproof. Lock the covers properly before approaching anywhere that is wet or dirty.

*2 The camera satisfies the PENTAX drop test (1.2 m height onto a 5 cm thick plywood surface) complying with MIL-Standard 810F Method 516.5-Shock testing.

- Waterproof performance is not guaranteed if the camera is exposed to impact such as being dropped or hit.
- The camera is not guaranteed to be free of trouble or damages under every condition.

- For taking enlarged pictures of very close objects such as the veins of leaves or specimens of tiny insects in Digital Microscope mode (p.99).
- For creating an image like an ink rubbing using the Ink Rubbing Filter (p.199).

Easy-to-Navigate Capture and Playback Functions!

The user-friendly design of the Optio W90 enables easy operation with only a few buttons. Simply by choosing the appropriate icon, you can select the shooting mode (p.79) and choose the optimal settings for the situation, or the playback mode (p.168) and enjoy the various playback and editing functions. A guide on the display lets you check the functions available in each mode and how to use them.

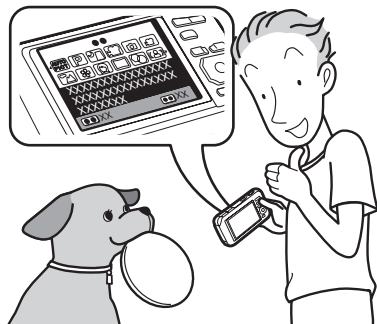

- A shooting mode guide is displayed in the Capture Mode Palette and a playback mode guide in the Playback Mode Palette (p.78, p.166).
- Use the Green Mode to take pictures easily using standard settings (p.86).

Perfect for Portrait Shots!

The Optio W90 comes with a “Face Detection” function that spots the faces in your shot and automatically adjusts the focus and exposure for the faces. It can recognize up to 32 people per shot (*), so it will help you take perfect group shots too. It will automatically release the shutter when people are smiling, or if anyone blinked, it will tell you that so you can take the shot again until it is perfect. It also has a feature that lets you enlarge each person’s face in sequence during playback so you can quickly check their facial expressions.

* Up to 31 face detection frames are displayed on the monitor.

- **Face Detection function (p.81).**
- **Modes for taking stunning pictures of people (p.91).**
- **Close-ups of people’s faces for easy checking during playback (p.174).**

Advanced Movie Recording Functions!

The Optio W90 includes Movie SR to reduce camera shake during movie recording (p.153). It also supports 1280×720 HDTV so you can view your recordings as stunning wide-screen movies.

- **Use the camera to shoot fun-filled movies of your children or pets as a visual diary of their development (p.150).**

A Multitude of Functions inside the Camera for Enjoying Images Without a Computer!

The Optio W90 has a variety of functions to let you enjoy playing back and editing images without having to connect the camera to your computer and transfer the images first. The camera is all you need to take and edit still pictures and movies (p.190). And no more worries about accidentally deleting images, because now, with the Optio W90, you can recover them again (p.180).

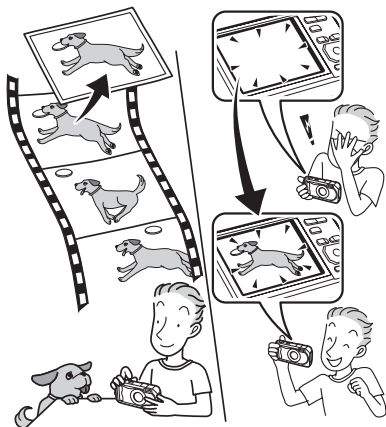

- **Resize (p.190), Cropping (p.191) and Red-eye Compensation (p.205) can be used, while the image is displayed in the playback mode.**
- **You can divide a movie in two or select a frame from a movie to save it as a still picture (p.214).**

Checking the Contents of the Package



Camera
Optio W90

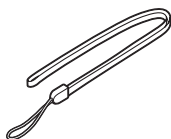

Strap
O-ST104 (*)

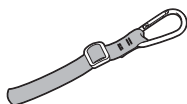

Carabiner strap
O-ST103 (*)

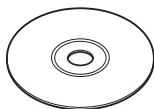

Software (CD-ROM)
S-SW102

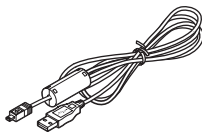

USB cable
I-USB7 (*)

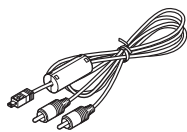

AV cable
I-AVC7 (*)



Rechargeable lithium-ion
battery D-LI88 (*)

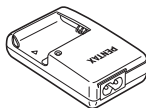

Battery charger
D-BC88 (*)



AC plug cord



Operating Manual
(this manual)



Quick Guide

Items marked with an asterisk (*) are also available as optional accessories. The battery charger and AC plug cord are only sold as a set (battery charger kit K-BC88).

For other optional accessories, refer to "Optional Accessories" (p.301).

Names of Parts

Front

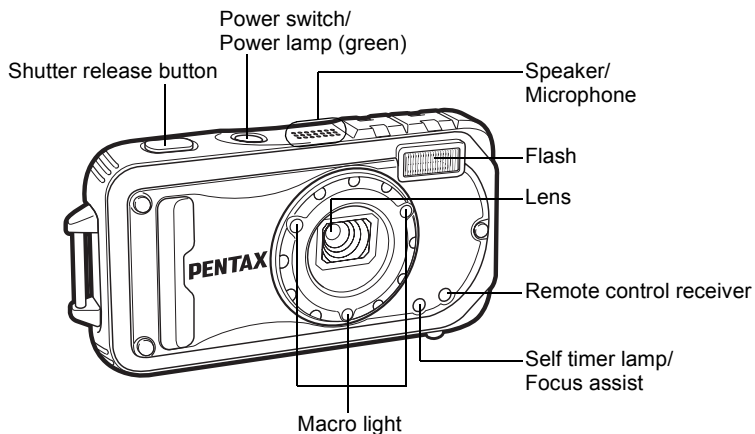

Back

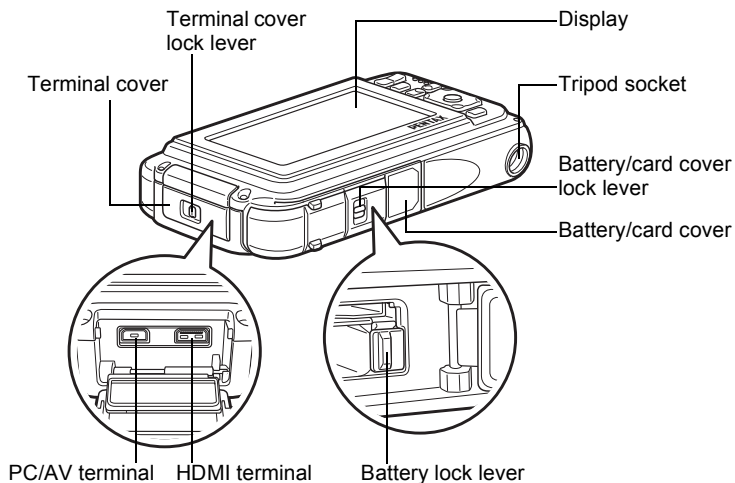

Names of Operating Parts

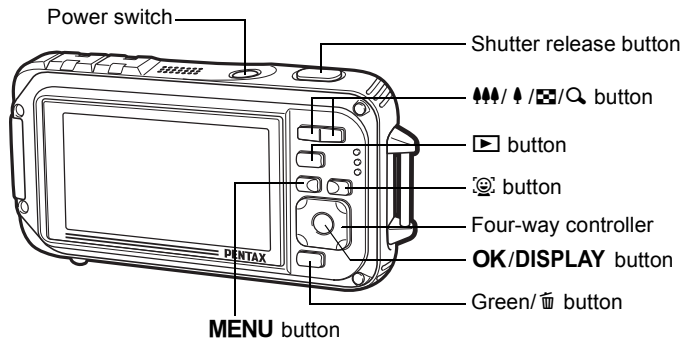





Refer to “Understanding the Button Functions” (p.60 - 63) for an explanation of the function of each button.

Monitor Indications

Display in Mode

The display changes in the following sequence each time you press the **OK/DISPLAY** button: “Normal Display”, “Histogram + Info”, “No Info”, “LCD Off”, “Simple Display + Subscreen”.



- All the camera buttons function as normal even when the LCD is off. Press the shutter release button to take pictures as normal.
-  appears if you press the shutter release button halfway when camera shake is likely to occur. To prevent the camera from shaking, use a tripod, a remote controller (optional) and/or the self-timer function (p.103, p.106).
- You cannot turn off the LCD or change the information on the display to “Simple Display + Subscreen” in  (Frame Composite) and  (Digital Panorama) modes.
- You cannot change the information on the display by pressing the **OK/DISPLAY** button in  (Green) mode or **WIDE** (Digital Wide) mode.
- In  (Digital Microscope) mode, the **OK/DISPLAY** button only switches between the Normal display and the No Info display.

Normal Display



Simple Display + Subscreen



LCD Off



Histogram + Info



No Info



Normal Display in Still Picture Capture Mode

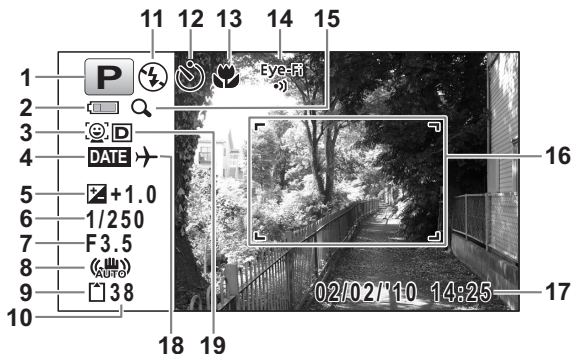



- | | |
|-------------------------------------|--|
| 1 Shooting mode (p.78) | 11 Flash mode (p.117) |
| 2 Battery level indicator (p.42) | 12 Drive mode (p.103 - p.110) |
| 3 Face Detection icon (p.81) | 13 Focus mode (p.119) |
| 4 Date Imprint setting (p.145) | 14 Eye-Fi communication status (p.249) |
| 5 EV Compensation (p.133) | 15 Digital Zoom/Intelligent Zoom icon (p.87) |
| 6 Shutter speed | 16 Focus frame (p.74) |
| 7 Aperture | 17 Date and time (p.55) |
| 8 Pixel Track SR icon (p.135) | 18 World Time setting (p.239) |
| 9 Memory status (p.49) | 19 D-Range Setting (p.134) |
| 10 Remaining image storage capacity | |

- * 6 and 7 are only displayed when the shutter release button is pressed half-way.
- * For 8, is displayed when Pixel Track SR is set to (On) on the [Rec. Mode] menu. is displayed when the shutter release button is pressed halfway if Pixel Track SR is set to (Off) and there is a danger of camera shake.
- * For 13, when the focus mode is set to **AF** and the Auto Macro function is activated, the appears on the display (p.119).

- * 14 changes as follows depending on the [Eye-Fi] setting in [⏏ Setting] menu.

Eye-Fi  During Eye-Fi communication. The camera is communicating or searching for the access point when [Eye-Fi] is set to (on).

Eye-Fi  Eye-Fi communication waiting. The camera is not communicating when [Eye-Fi] is set to (on).

Eye-Fi  Eye-Fi communication prohibited. [Eye-Fi] is set to (off).

Eye-Fi  Eye-Fi version error. The version of the Eye-Fi card is out of date.

- * 17 disappears two seconds after the camera is turned on.
- * 19 depends on the [D-Range Setting] setting in the [📷 Rec. Mode] menu.

 When [Highlight Correction] is set to

 When [Shadow Correction] is set to

 When [Highlight Correction] and [Shadow Correction] are both set to

If [Highlight Correction] and [Shadow Correction] are both set to (Off), nothing appears in 19.



- * Some indications may not appear depending on the shooting mode.



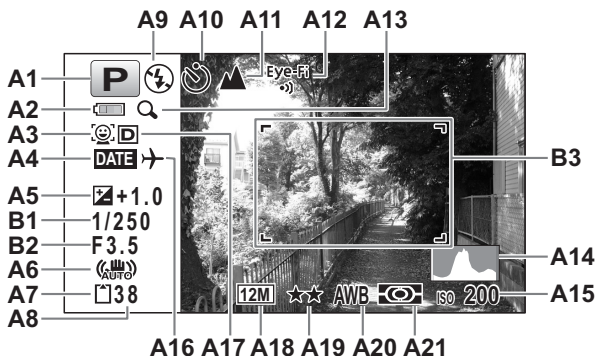



Histogram + Info/No Info Display in Still Picture Capture Mode

A1 to A21 and B3 appear when “Histogram + Info” is selected. Only B3 appears when “No Info” is selected.



- | | |
|--|--|
| A1 Shooting mode (p.78) | A13 Digital Zoom/Intelligent Zoom icon (p.87) |
| A2 Battery level indicator (p.42) | A14 Histogram (p.34) |
| A3 Face Detection icon (p.81) | A15 Sensitivity (p.131) |
| A4 Date Imprint setting (p.145) | A16 World time setting |
| A5 EV Compensation (p.133) | A17 D-Range Setting (p.134) |
| A6 Pixel Track SR icon (p.135) | A18 Recorded pixels (p.125) |
| A7 Memory status (p.49) | A19 Quality Level (p.127) |
| A8 Remaining image storage capacity | A20 White Balance (p.128) |
| A9 Flash mode (p.117) | A21 AE Metering (p.130) |
| A10 Drive mode (p.103 - p.110) | B1 Shutter speed |
| A11 Focus mode (p.119) | B2 Aperture |
| A12 Eye-Fi communication status (p.249) | B3 Focus frame (p.74) |

* For A6,  is displayed when Pixel Track SR is set to (On) on the [Rec. Mode] menu.  is displayed when the shutter release button is pressed halfway if Pixel Track SR is set to (Off) and there is a danger of camera shake.

- * A12 changes as follows depending on the [Eye-Fi] setting in [Setting] menu.
 - Eye-Fi  During Eye-Fi communication. The camera is communicating or searching for the access point when [Eye-Fi] is set to (on).
 - Eye-Fi  Eye-Fi communication waiting. The camera is not communicating when [Eye-Fi] is set to (on).
 - Eye-Fi  Eye-Fi communication prohibited. [Eye-Fi] is set to (off).
 - Eye-Fi  Eye-Fi version error. The version of the Eye-Fi card is out of date.
- * A17 depends on the [D-Range Setting] setting in the [Rec. Mode] menu.
 -  When [Highlight Correction] is set to
 -  When [Shadow Correction] is set to
 -  When [Highlight Correction] and [Shadow Correction] are both set to

If [Highlight Correction] and [Shadow Correction] are both set to (Off), nothing appears in A17.
- * B1 and B2 are only displayed when the shutter release button is pressed half-way.
- * When the shooting mode is  (Auto Picture) and if you press the shutter release button halfway, the automatically selected shooting mode appears in A1 even when “No Info” is selected (p.83).
- * Some indications may not appear depending on the shooting mode.
- * When there is an area on the screen that is so bright it appears white, the indicated area blinks red as a warning. Similarly, when there is an area that is so dark it appears black, the indicated area blinks yellow as a warning.

Simple Display + Subscreen in Still Picture Capture Mode

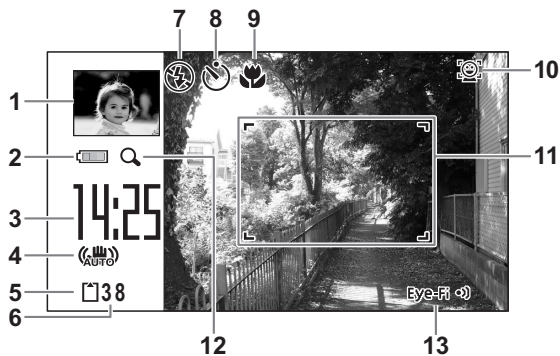

- | | |
|---------------------------------------|--|
| 1 Subscreen image (p.256) | 8 Drive Mode (p.103 - p.110) |
| 2 Battery level indicator (p.42) | 9 Focus Mode (p.119) |
| 3 Current time (p.55) | 10 Face Detection icon (p.81) |
| 4 Camera shake reduction icon (p.135) | 11 Focus frame (p.74) |
| 5 Memory status (p.49) | 12 Digital Zoom/
Intelligent Zoom icon (p.87) |
| 6 Remaining image storage capacity | 13 Eye-Fi communication status (p.249) |
| 7 Flash Mode (p.117) | |

* For 9, when the focus mode is set to **AF** and the Auto-Macro function is activated, the 🍄 appears on the display (p.119).

* Some indications may not appear depending on the shooting mode.

Display in Mode

The display shows the shooting information of the image in the playback mode. The display changes in the following sequence each time you press the **OK/DISPLAY** button:



The display cannot be changed by pressing the **OK/DISPLAY** button while playing back a voice memo/movie or pausing playback.

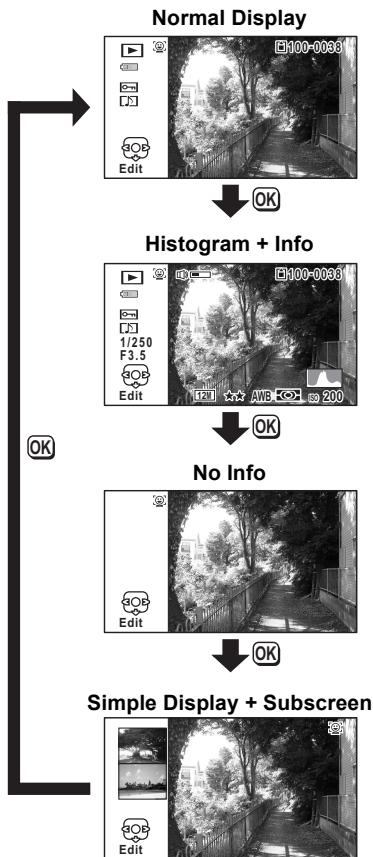

Histogram + Info Display in Playback Mode

(All of the display items are displayed here for explanatory purposes.)

The display shows information such as the shooting conditions. A1 to A11 also appear when “Normal Display” is selected. B1 to B8 appear only when “Histogram + Info” is selected.



- | | |
|--|--|
| A1 Face Detection icon (p.81) | A10 Eye-Fi communication status (p.249) |
| A2 Playback mode
▶ : Still Picture (p.162)
▶ : Movie (p.163)
▶ : Sound (p.226) | A11 Volume icon |
| A3 Battery level indicator (p.42) | B1 Shutter speed |
| A4 Protect icon (p.181) | B2 Aperture |
| A5 Voice memo icon (p.229) | B3 Histogram (p.34) |
| A6 Four-way controller guide | B4 Sensitivity (p.131) |
| A7 File number | B5 Recorded pixels (p.125) |
| A8 Folder number (p.244) | B6 Quality Level (p.127) |
| A9 Memory status (p.49) | B7 White Balance (p.128) |
| | B8 AE Metering (p.130) |

- * A1 appears only if the Face Detection function worked when the image was shot.
- * In “Normal Display”, A3 disappears if no operation is performed for two seconds.
- * A6 appears even when “No Info” is selected, but disappears if no operation is performed for two seconds. When no operation is performed for two seconds in “Normal Display” or “Histogram + Info”, only “Edit” disappears.

- * A11 appears only when the volume is being adjusted during playback of movies, sounds, or voice memos (p.163, p.226, p.229).
- * When “Normal Display” is selected, the current date and time appears for two seconds in the B4 to B8 positions.
- * When there is an area on the screen that is so bright it appears white, the indicated area blinks red. Similarly, when there is an area that is so dark it appears black, the indicated area blinks yellow.

Simple Display + Subscreen in Playback Mode

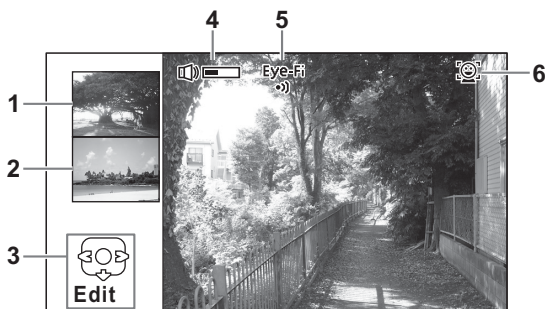

- | | |
|-----------------------------|---------------------------------------|
| 1 Next image | 5 Eye-Fi communication status (p.249) |
| 2 Previous image | 6 Face Detection icon (p.81) |
| 3 Four-way controller guide | |
| 4 Volume icon | |

* For 3, when no operation is performed for two seconds, only “Edit” disappears.

Guide Display

A guide for each available button operation appears as follows on the display during operation.

▲	Four-way controller (▲)
▼	Four-way controller (▼)
◀	Four-way controller (◀)
▶	Four-way controller (▶)
MENU	MENU button

	Zoom button
OK	OK/DISPLAY button
SHUTTER	Shutter release button
	Green/ button
	button

Histogram

A histogram shows the brightness distribution of an image. The horizontal axis represents brightness (dark at the left and bright at the right) and the vertical axis represents the number of pixels.

The shape of the histogram before and after shooting tells you whether the brightness and contrast are correct or not, and lets you

decide if you need to use EV compensation and take the picture again.

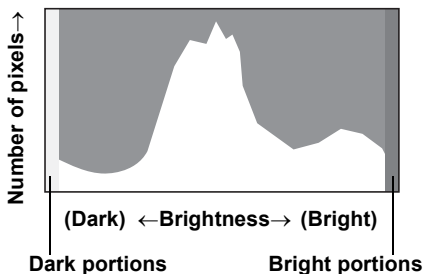

Setting the Exposure (EV Compensation) p.133

Understanding Brightness

If the brightness is correct, the graph peaks in the middle. If the image is too dark, the peak is on the left side, and if it is too bright, the peak is on the right side.

Dark image

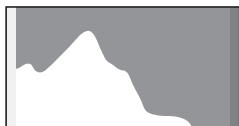

Correct image

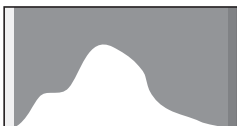

Bright image

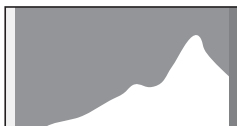

When the image is too dark, the part to the left is cut off (dark portions) and when the image is too bright, the part to the right is cut off (bright portions).

The Optio W90 has a function where bright portions are indicated as blinking red and dark portions as blinking yellow.

Understanding Contrast

The graph peaks gradually for images in which contrast is balanced. The graph peaks on both sides but sinks in the middle for images with a large difference in contrast and low amounts of mid-level brightness.

1 Getting Started

Attaching the Strap	36
Powering the Camera	38
Installing the SD Memory Card	45
Turning the Camera On and Off	49
Initial Settings	51

Attaching the Strap

Attaching the Strap

Attach the strap (O-ST104) supplied with the camera.

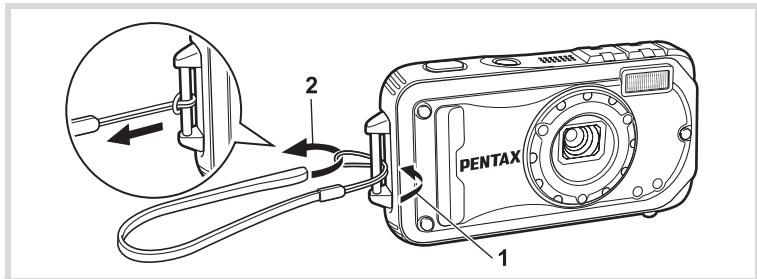

- 1** Pass the narrow end of the strap through the strap lug.
- 2** Pass the other end of the strap through the loop and pull tight.

Attaching the Carabiner Strap

Attach the carabiner strap (O-ST103) supplied with the camera.

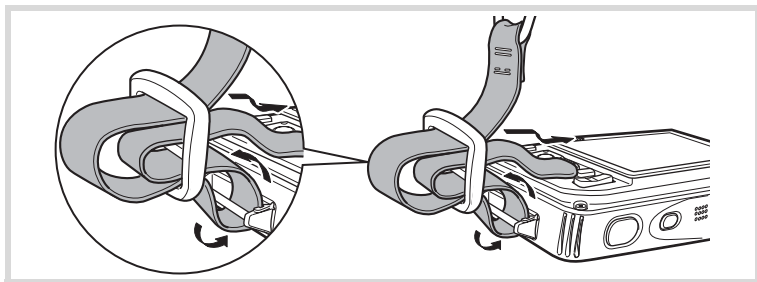

- 1** Pass the narrow end of the strap through the strap lug on the camera.
- 2** Fix the end of the strap to the stopper.

Protective rubber ring

The carabiner has rubber rings to prevent damage to the display. These rubber rings cushion the impact when the carabiner hits the display.

Be sure to adjust the position of the rubber rings as shown in the figure below for the best results before using the carabiner strap.

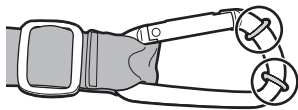

Powering the Camera

1

Getting Started

Charging the Battery

Use the supplied battery charger (D-BC88) to charge the supplied rechargeable lithium-ion battery (D-LI88) before using it in the camera for the first time or after a long period of non-use, or when the [Battery depleted] message appears.

Note: AC plug cord “Listed, Type SPT-2 or NISPT-2, 18/2 flexible cord, rated 125 V, 7A, minimum 6 ft (1.8 m)”

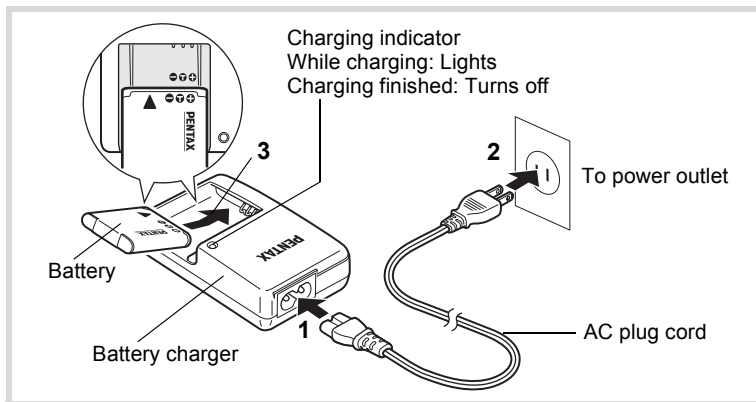

- 1** Connect the AC plug cord to the battery charger.
- 2** Plug the AC plug cord into the power outlet.
- 3** Place the battery in the battery charger so that the **PENTAX** logo is facing up.
The charging indicator turns on while charging.
When charging is finished, the charging indicator turns off.
- 4** Remove the battery from the battery charger when charging is finished.



- Do not charge batteries other than the rechargeable lithium ion D-LI88 battery using the supplied D-BC88 battery charger. Doing otherwise may cause damage or overheating.
- The battery has reached the end of its service life when it starts to run down soon after being charged. Replace it with a new battery.
- If the battery is inserted correctly but the charging indicator fails to light, the battery may be faulty. Replace it with a new battery.



The time required to fully charge the battery is about 120 minutes (max.). (The charging time may vary depending on the ambient temperature and charging conditions.) The appropriate ambient temperature for charging the battery is 0°C to 40°C (32°F to 104°F).

Installing the Battery

Use the rechargeable lithium-ion battery D-LI88 that is provided with the camera. Charge the battery before using it in the camera for the first time.

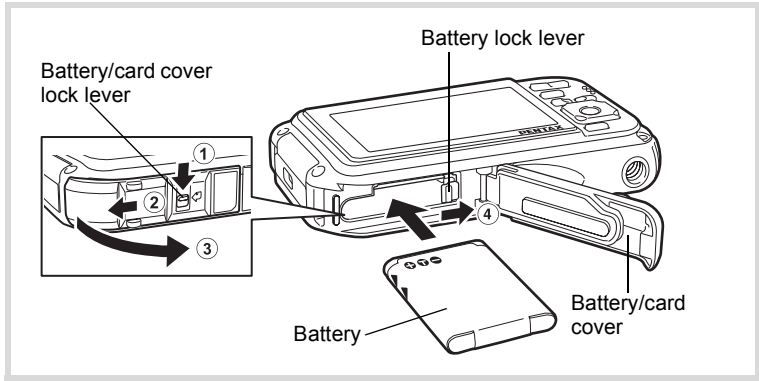

1 Open the battery/card cover.

Press the battery/card cover lock lever in the direction shown ①, slide the cover towards ② and open it towards ③.

-
- 2 Using the side of the battery to press the battery lock lever in the direction of ④, insert the battery with the PENTAX logo pointing toward the lens.**

Push the battery in until it is locked in place.



Make sure that the battery is inserted with the PENTAX logo pointing toward the lens. If the battery is incorrectly oriented, malfunction may result.

-
- 3 Close the battery/card cover.**

While lightly pressing the battery/card cover in the opposite direction indicated by ②, slide the cover. The cover clicks to confirm that it is securely closed.

Removing the Battery

- 1 Open the battery/card cover.**

- 2 Press the battery lock lever towards ④.**

The battery will be ejected. Take care not to drop the battery when removing it.



- Do not use excessive force when sliding the battery/card cover open and closed because the waterproof packing may peel off. If the packing is not in the correct position, the camera will not be waterproof.
- If the battery/card cover is not locked securely when you close it, water, sand, or dirt may get into the camera.
- This camera uses a rechargeable lithium-ion battery D-LI88. Use of any other type of battery may damage the camera and cause malfunction.
- Insert the battery correctly. If the battery is incorrectly oriented, malfunction may result.
- Do not remove the battery while the camera is turned on.
- When storing the battery for more than 6 months, charge the battery for 30 minutes using the battery charger and store the battery separately.

Be sure to recharge the battery every 6 to 12 months. Storing the battery below room temperature is ideal. Avoid storing it in high temperatures.

- The date and time may be returned to the default setting if the camera is left without the battery for a long time.
- Be careful as the camera or the battery may become hot when the camera is used continuously for a long period of time.
- Allow the camera to dry completely before changing the battery. Avoid changing the battery where the camera is likely to get wet or dirty, and make sure that your hands are dry.
- Battery performance may deteriorate as temperature decreases. When using the camera in cold regions, we recommend carrying a spare battery in your pocket to keep it warm. Battery performance will return to normal in normal temperatures.

- **Image Storage Capacity, Movie Recording Time, Sound Recording Time, and Playback Time**
(at 23°C or 73.4°F with the display on and the battery fully charged)

Image Storage Capacity ^{*1} (flash used for 50% of shots)	Movie Recording Time ^{*2}	Sound Recording Time ^{*2}	Playback Time ^{*2}
Approx. 205 pictures	Approx. 85 min.	Approx. 300 min.	Approx. 250 min.

*1 Recording capacity shows approximate number of shots recorded during CIPA-compliant testing (with display on, flash used for 50% of the shots, and 23°C or 73.4°F). Actual performance may vary according to operating conditions.

*2 According to the results of in-house testing.



- In general, battery performance may temporarily deteriorate as the temperature decreases.
- Be sure to take a spare battery with you when traveling abroad or to a cold region, or if you intend to take a lot of pictures.

• Battery Level Indicator

You can check the battery level by the indicator on the display.

Screen Display	Battery Status
(green)	Adequate power remains.
(green)	Battery is running low.
(yellow)	Battery is running very low.
(red)	Battery is exhausted.
[Battery depleted]	The camera will turn off after this message appears.

Using the AC Adapter

Use of the optional AC adapter kit (K-AC88) is recommended if you intend to use the camera for a long time or connect it to a computer.

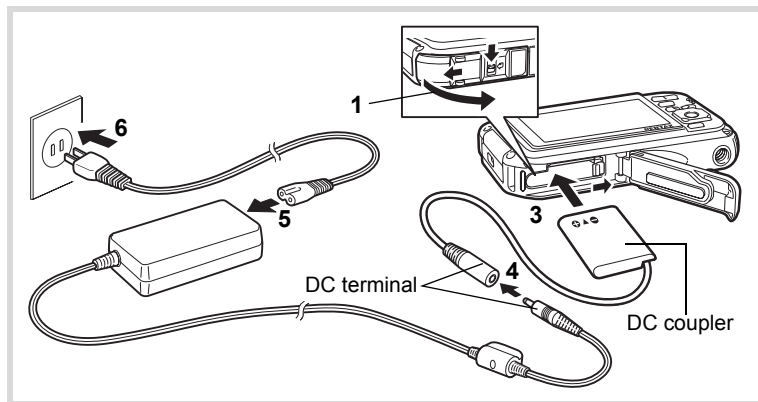

- 1 Make sure that the camera is turned off and open the battery/card cover.**
- 2 Remove the Battery.**

Refer to p.39 - p.40 on how to open the battery/card cover and remove the battery.
- 3 Insert the DC coupler.**

Using the side of the DC coupler to press the battery lock lever, insert the DC coupler. Confirm that the DC coupler is locked in place. The battery/card cover will not close while the DC coupler is inserted. Leave the cover open when using the AC adapter and do not attempt to close it.
- 4 Connect the DC terminal of the AC adapter to the DC terminal of the DC coupler.**
- 5 Connect the AC plug cord to the AC adapter.**
- 6 Plug the AC plug cord into the power outlet.**

- Make sure that the camera is turned off before connecting or disconnecting the AC adapter.
- Make sure that the AC plug cord and the DC terminal connecting the AC adapter to the camera are inserted securely. Data may be lost if either becomes disconnected while data is being recorded on the SD Memory Card or the built-in memory.
- Use the AC adapter with due care to avoid fire or electric shock. Be sure to read “About the Battery Charger and the AC Adapter” (p.3) before using the AC adapter.
- Be sure to read the operation manual accompanying the AC adapter kit K-AC88 before using the adapter.
- When connecting the AC adapter, you cannot set the camera upright on the table because the cord from the DC coupler comes out of the bottom of the camera.
- Do not use excessive force when sliding the battery/card cover open and closed because the waterproof packing may peel off. If the packing is not in the correct position, the camera will not be waterproof.

Installing the SD Memory Card

This camera uses either an SD Memory Card or an SDHC Memory Card. (Both cards are referred to as SD Memory Cards hereafter.) Captured images and sound files are saved on the SD Memory Card if a card is inserted in the camera. They are saved in the built-in memory if a card is not inserted (p.49).



- **Be sure to use this camera to format (initialize) an SD Memory Card that is unused or has been used on other cameras or digital devices. Refer to “Formatting an SD Memory Card” (p.232) for instructions on formatting.**
- Make sure that the camera is turned off before inserting or removing the SD Memory Card.
- Allow the camera to dry completely before changing the SD Memory Card. Avoid changing the card where the camera is likely to get wet or dirty, and make sure that your hands are dry.
- Do not use excessive force when sliding the battery/card cover open and closed because the waterproof packing may peel off. If the packing is not in the correct position, the camera will not be waterproof.



- The still picture storage capacity varies depending on the capacity of the SD Memory Card and the selected number of recorded pixels and quality level (p.303).
- The power lamp blinks while the SD Memory Card is being accessed (data is being recorded or read).

Backing Up Data

The camera may not be able to access data in the built-in memory in the case of a malfunction. Use a computer or other device to back up important data in another location.

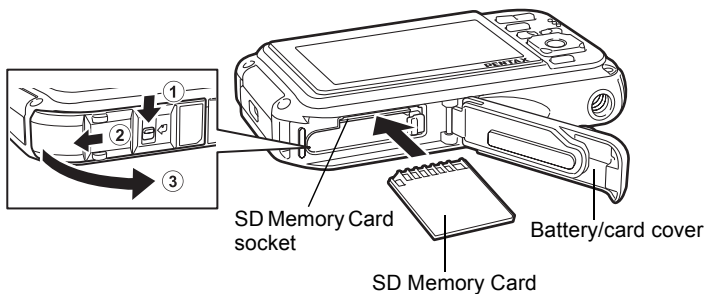

- 1 Open the battery/card cover.**

Press the battery/card cover lock lever in the direction shown ①, slide the cover towards ② and open it towards ③.
- 2 Insert the SD Memory Card into the SD Memory Card socket so that the label is facing toward the front of the camera (the side with the lens).**

Push the card in all the way. Images and sound may not be recorded correctly if the card is not inserted all the way.
- 3 Close the battery/card cover.**

While lightly pressing the battery/card cover in the opposite direction indicated by ②, slide the cover. The cover clicks to confirm that it is securely closed.

To Remove the SD Memory Card

- 1 Open the battery/card cover.**
- 2 Push the card into the SD Memory Card socket to eject it.**

Pull the card out.



If the battery/card cover is not locked securely when you close it, water, sand, or dirt may get into the camera.

Precautions When Using an SD Memory Card

- The SD Memory Card is equipped with a write-protect switch. Setting the switch to LOCK prevents new data from being recorded on the card, the stored data from being deleted, and the card from being formatted by the camera or a computer.  appears on the display when the card is write-protected.

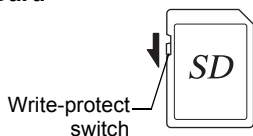

- Care should be taken when removing the SD Memory Card immediately after using the camera, as the card may be hot.
- Keep the card cover closed and do not remove the SD Memory Card or turn off the camera while the image is being written or played back from the SD Memory Card or while connected to a computer with a USB cable. Doing so may result in data corruption or damage to the card.
- Do not bend the SD Memory Card or subject it to violent impact. Keep it away from water and store away from high temperature.
- Never remove the SD Memory Card while it is being formatted. This may damage the card and make it unusable.
- The data on the SD Memory Card may be deleted in the following circumstances. We do not accept any liability for data that is deleted. This includes the following:
 - (1) When the SD Memory Card is mishandled by the user.
 - (2) When the SD Memory Card is exposed to static electricity or electrical interference.
 - (3) When the SD Memory Card has not been used for a long time.
 - (4) When the SD Memory Card is ejected or the battery is removed while the data on the card is being recorded or accessed.
- If it is not used for a long time, the data on the card may become unreadable. Be sure to regularly make a backup of important data on a computer.
- Avoid using or storing the card where it may be exposed to static electricity or electrical interference.
- Avoid using or storing the card in direct sunlight or where it may be exposed to rapid changes in temperature or to condensation.
- When using an SD Memory Card with a slow recording speed, recording may stop while you are taking movies even when there is adequate space in the memory, or shooting and playback may take a long time.
- Be sure to format SD Memory Cards that are unused or have been used on another camera. Refer to "Formatting an SD Memory Card" (p.232).

Number of Images Recordable on an SD Memory Card

1

Getting Started

The size of a recorded image differs depending on the number of recorded pixels of the images. This affects the number of images that can be saved on an SD Memory Card.

Choose the appropriate number of recorded pixels for still pictures on the [📷 Rec. Mode] menu.

Selecting the Number of Recorded Pixels 📷 p.125

Choose the appropriate number of recorded pixels and frame rate in [Movie] on the [📷 Rec. Mode] menu.

Selecting the Number of Recorded Pixels and Frame Rate for Movies 📷 p.152

For an approximate guide to the number of images or the length of recorded movies that can be saved on an SD Memory Card, see “Main Specifications” (p.302).

Turning the Camera On and Off

1

Getting Started

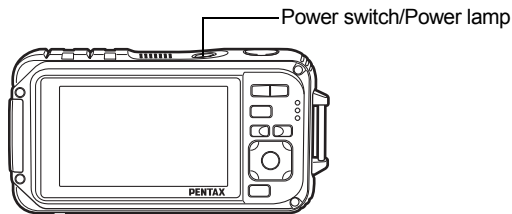

1 Press the power switch.

The camera turns on and both the power lamp and display turn on. If the [Language/言語] screen or [Date Adjustment] screen appears when you turn the camera on, follow the procedure on p.51 to set the display language and/or current date and time.

2 Press the power switch again.

The camera turns off and both the power lamp and display turn off.

Taking Still Pictures p.74

Checking the SD Memory Card

The SD Memory Card is checked when the camera turns on and the memory status is displayed.

	The SD Memory Card is inserted. Images and sound files will be saved on the SD Memory Card.
	The SD Memory Card is not inserted. Images and sound files will be saved in the built-in memory.
	The write-protect switch on the SD Memory Card is in the LOCK position (p.47). Images and sounds cannot be recorded.



Memory status

Starting-up in the Playback Mode

Use this function when you want to play back images or sound files straightaway without taking any pictures.

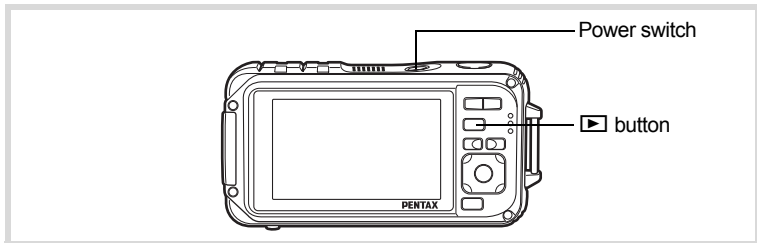

1 Press the power switch while holding down the ▶ button.

The display turns on and the camera starts up in playback mode.



To switch from Playback Mode to  mode, press the ▶ button or press the shutter release button halfway.

Playing Back Still Pictures  p.162

Initial Settings

1

Getting Started

The [Language/言語] screen appears when the camera is turned on for the first time. Perform the operations in “Setting the Display Language” below to set the language, and in “Setting the Date and Time” (p.55) to set the current date and time.

The language, date, and time can be changed later. Refer to the pages below for instructions.

- To change the language, follow the steps in “Changing the Display Language” (p.243).
- To change the date and time, follow the steps in “Changing the Date and Time” (p.235).

Setting the Display Language

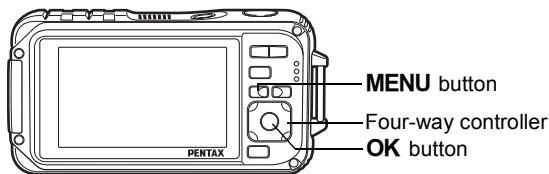

- 1 Use the four-way controller (▲▼◀▶) to choose the display language.

Language/言語		
English	日本語	Türkçe
Français	Dansk	Ελληνικά
Deutsch	Svenska	Русский
Español	Suomi	ไทย
Português	Polski	한국어
Italiano	Čeština	中文繁體
Nederlands	Magyar	中文简体
[MENU] Cancel		[OK] OK

2 Press the OK button.

The [Initial Setting] screen appears in the selected language. If the desired settings for [Hometown] and [DST] (Daylight Saving Time) appear, proceed to Step 3.

Proceed to "To Set Hometown and DST" (p.54) if the desired settings do not appear.

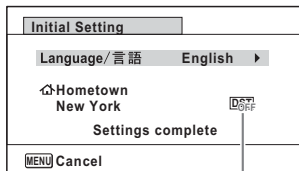

Daylight saving time

3 Press the four-way controller (▼) twice to select [Settings complete].

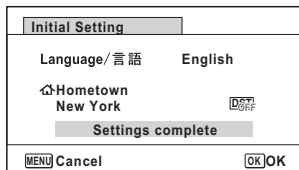

4 Press the OK button.

The [Date Adjustment] screen appears. Set the date and time by following the procedure in "Setting the Date and Time" (p.55).

If you accidentally select the wrong language and go to the next procedure, perform the following operation to set the language back.

● **When the Wrong Language Has Been Inadvertently Selected**

- 1 Press the four-way controller (▶).**
- 2 Use the four-way controller (▲ ▼ ◀ ▶) to select the language and press the OK button.**
The [Initial Setting] screen appears in the selected language.

● **When the Screen After Step 2 Appears in the Wrong Language**

- 1 Press the MENU button.**
This exits the settings screen and returns the camera to capture mode.
- 2 Press the MENU button.**
The [📷 Rec. Mode] menu appears.
- 3 Press the four-way controller (▶).**
- 4 Use the four-way controller (▼ ▲) to select [Language/言語].**
- 5 Press the four-way controller (▶).**
The [Language/言語] screen appears.
- 6 Use the four-way controller (▲ ▼ ◀ ▶) to select the language.**
- 7 Press the OK button.**
The [🔧 Setting] menu appears in the selected language.

The language is now switched to your desired language. To reset [Hometown], [Date] and [Time], refer to the pages below for instructions.

- To change [Hometown], follow the steps in "Setting the World Time" (p.239).
- To change the date and time, follow the steps in "Changing the Date and Time" (p.235).

To Set Hometown and DST

1

Getting Started

- 3** Press the four-way controller (▼).

The frame moves to [Hometown].

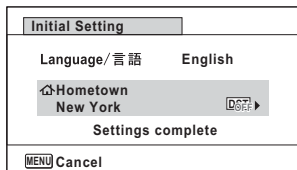

- 4** Press the four-way controller (▶).

The [Hometown] screen appears.

- 5** Use the four-way controller (◀▶) to choose a city.

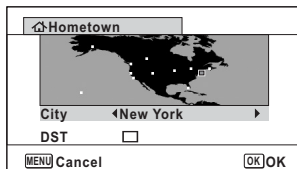

- 6** Press the four-way controller (▼).

The frame moves to [DST] (Daylight Saving Time).

- 7** Use the four-way controller (◀▶) to select or .

- 8** Press the OK button.

The [Initial Setting] screen reappears.

- 9** Press the four-way controller (▼) to select [Settings complete].

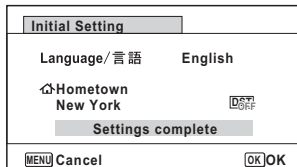

- 10** Press the OK button.

The [Date Adjustment] screen appears. Next, set the date and time.

The video output format (NTSC/PAL) is set to the format of the city selected in [Hometown] on the [Initial Setting] screen. See the following pages for information on the available video output formats and how to change the initial settings.

- Video output formats available initially: “List of World Time Cities” (p.300)
- To change the video out format, follow the steps in “Changing the Video Output Format” (p.246).

Setting the Date and Time

Set the current date and time and the display format.

1 Press the four-way controller (▶).

The frame moves to [mm/dd/yy].

2 Use the four-way controller (▲▼) to choose the date and time display format.

Choose from [mm/dd/yy], [dd/mm/yy] or [yy/mm/dd].

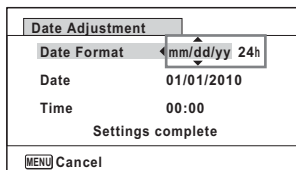

3 Press the four-way controller (▶).

The frame moves to [24h].

4 Use the four-way controller (▲▼) to select [24h] (24-hour display) or [12h] (12-hour display).

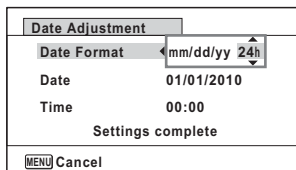

5 Press the four-way controller (▶).

The frame returns to [Date Format].

6 Press the four-way controller (▼).

The frame moves to [Date].

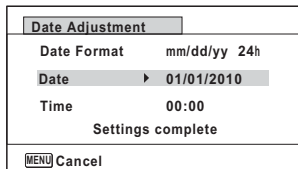

7 Press the four-way controller (▶).

The frame moves to the month.

8 Use the four-way controller (▲▼) to change the month.

Change the day and year in the same manner.

Next, change the time.

If you selected [12h] in step 4, the setting switches between am and pm corresponding to the time.

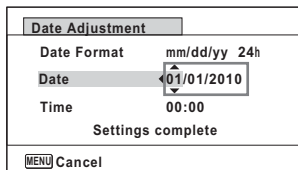

9 Press the four-way controller (▼) to select [Settings complete].

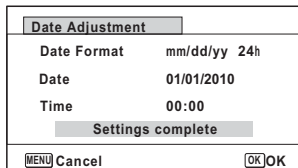

10 Press the OK button.

This confirms the date and time.



If you press the **OK** button in step 10, the camera clock is reset to 00 seconds. To set the exact time, press the **OK** button when the time signal (on the TV, radio, etc.) reaches 00 seconds.



When the [Initial Setting] or [Date Adjustment] screen is displayed, you can cancel the setting operation and switch to the capture mode by pressing the **MENU** button. In this case, the [Initial Setting] screen will appear next time you turn the camera on.

[Language/言語], [Date], [Time], [Hometown] and [DST] can be changed. Refer to the pages below for instructions.

- To change the language, follow the steps in “Changing the Display Language” (p.243).
- To change the date and time, follow the steps in “Changing the Date and Time” (p.235).
- To change the city or turn DST on and off, follow the steps in “Setting the World Time” (p.239).

Memo

2 Common Operations

Understanding the Button Functions	60
Setting the Camera Functions	65

Understanding the Button Functions

Mode

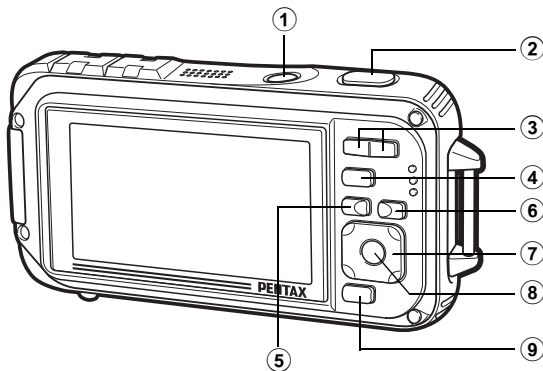

① Power switch

Turns the camera on and off (p.49).

② Shutter release button

Focuses the camera on the subject when pressed halfway in Still Picture Capture Mode (except when the focus mode is set to **PF**, **▲**, and **MF**) (p.75).

Takes a still picture when pressed down fully (p.75).

Pressing down fully starts and stops movie recording in **MOVIE** (Movie) and **UNDERWATER MOVIE** (Underwater Movie) modes (p.148, p.151).

Pressing down fully starts and stops sound file recording in **VOICE RECORDING** (Voice Recording) mode (p.225).

③ **AAA/▲** button

Changes the captured area (p.87).

④ **▶** button

Switches to the **▶** mode (p.64).

⑤ **MENU** button

Displays the [**MOVIE** Rec. Mode] menu (p.65).

⑥

☺ button

Switches the Face Detection function (p.81). The Face Detection function is switched as follows each time the ☺ button is pressed:

Smile Capture → Face Detection Off → Face Detection On

The Face Detection function cannot be set to off in  (Auto Picture)/

 (Night Scene Portrait)/ (Portrait)/ (Kids) modes.

⑦

Four-way controller

(▲) : Changes the drive mode (p.103 - p.110).

(▼) : Displays the Capture Mode Palette (p.79).

(◀) : Changes the flash mode (p.117).

(▶) : Changes the focus mode (p.119).

(▲▼) : Adjusts the focus when the focus mode is set to **MF** (p.120).

⑧

OK/DISPLAY button

Changes the information on the display (p.24).

⑨

Green button

Switches to the  (Green) mode (p.86).

Calls up the assigned function (p.139).

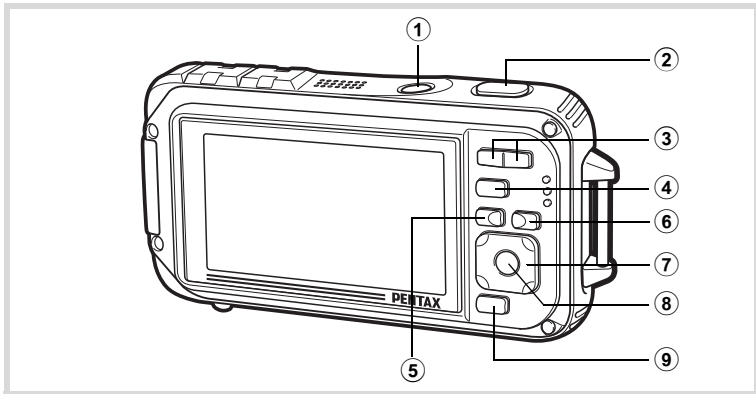

- ① **Power switch**
Turns the camera on and off (p.49).
- ② **Shutter release button**
Switches to mode (p.64).
- ③ **/Q button**
In single-image display, pressing switches to 6-image display. Pressing again switches to 12-image display (p.164). Press to return to the previous display.
In single-image display, pressing enlarges the image. Press to return to the previous display (p.173).
In 12-image display press to change to folder or calendar display (p.165).
In folder/calendar display, press to change to 12-image display (p.165, p.166).
Adjusts the volume during playback of movies, sound files or voice memo (p.163, p.226, p.229).
- ④ **button**
Switches to mode (p.64).
- ⑤ **MENU button**
Displays the [Setting] menu during single-image display (p.65).
Returns to single-image display during Playback Mode Palette display (p.167).
Returns zoom, 6- or 12-image display to single-image display.

Changes to 12-image display of the selected folder during folder display (p.166).
Changes to 12-image display of the selected date during calendar display (p.166).

6 button

Zooms up on the subjects' faces in the order in which they were recognized during shooting (Face close-up playback) (p.174).

7 **Four-way controller**

(▲) : Plays back and pauses a movie or sound file (p.163, p.226, p.229).

(▼) : Displays the Playback Mode Palette (p.168).
Stops a movie or sound file during playback (p.163, p.227, p.229).

(◀▶) : Displays the previous or next image and sound file during single-image display (p.162).
Fast-forwards, fast-reverses, frame forwards, frame reverses, reverses a movie and makes a movie play forwards during playback (p.163).
Fast forwards, reverses, and moves to the next index in sound file playback (p.226).

(▲▼◀▶) : Moves the display area during zoom display (p.173).
Selects an image in 6- or 12-image display, a folder in folder display, and a date in calendar display (p.164, p.165, p.166).
Moves the image when using the Frame Composite function (p.207).
Adjusts the position of a frame or an image when you are using the Original Frame function (p.211).

8 **OK/DISPLAY button**

Changes the information on the display (p.31).

Returns zoom, 6- or 12-image display to single-image display (p.165, p.173).

Changes to 12-image display of the selected folder during folder display (p.165).

Changes to single-image display of the selected date during calendar display (p.166).

9 **Green/ button**



Switches from single-image display to the Delete screen (p.176).



Switches from 6- or 12-image display to the Select & Delete screen (p.178).

Switches from folder display to the calendar display screen (p.165).

Switches from calendar display to the folder display screen (p.165).

Switching Between Mode and Mode

In this manual, the capture mode, such as for taking still pictures, is referred to as “ mode” (the capture mode). The playback mode, such as for displaying captured images on the monitor, is referred to as “ mode” (the playback mode). In  mode, you can perform simple editing operations on the images that are played back.

Follow the procedure below to switch between  mode and  mode.

To Switch from Mode to Mode

1 Press the button.

The camera switches to  mode.

To Switch from Mode to Mode

1 Press the button or the shutter release button halfway.

The camera switches to  mode.



Displaying data stored in the built-in memory

When an SD Memory Card is inserted in the camera, images, movies, and sounds on the SD Memory Card are displayed. If you want to display images, movies, and sounds stored in built-in memory, turn the camera off and remove the SD Memory Card, or follow the procedure below to use the “Built-in memory display” function.



Make sure that the camera is turned off before inserting or removing the SD Memory Card.

• Viewing images stored in built-in memory while the SD Memory Card is inserted (built-in memory display)

When you press and hold down the  button for more than one second in  mode, images, movies and sound files stored in the built-in memory are displayed after the message [Displays image/sound from built-in memory] appears.

- In the built-in memory display, you can play back still pictures (including enlarged display) (p.162, p.173), play back movies (p.163), play back sounds (p.226), and switch between 6- or 12-image display, folder display, and calendar display (p.164, p.165).
- In the built-in memory display, you cannot delete data, delete a selection, display the Playback Mode Palette or display the menu. If you want to perform any of these operations on images, movies, or sounds in the built-in memory, do so after removing the SD Memory Card.

Setting the Camera Functions

To change the camera settings, press the **MENU** button to display the [📷 Rec. Mode] menu or [⚙️ Setting] menu. Functions for playing back and editing images and sound files are displayed from the Playback Mode Palette.

Operating the Menus

Press the **MENU** button in 📷 mode to display the [📷 Rec. Mode] menu. Press the **MENU** button in ▶ mode to display the [⚙️ Setting] menu. Use the four-way controller (◀▶) to switch between [📷 Rec. Mode] menu and [⚙️ Setting] menu.

During recording

During playback



MENU

MENU

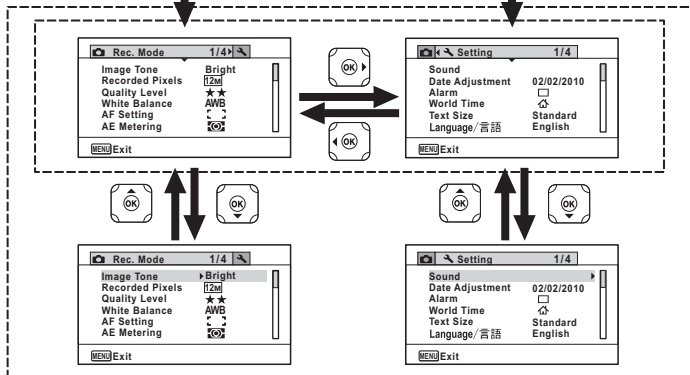

SHUTTER
Press halfway

MENU



The setting is complete and the camera returns to **P** mode.



The setting is complete and the camera returns to **▶** mode.



Available button operations appear on the display during menu operation.

e.g.: To set the [Quality Level] on the [📷 Rec. Mode] menu

1 Press the MENU button in 📷 mode.

The [📷 Rec. Mode] menu appears.

2 Press the four-way controller (▼).

The frame moves to [Image Tone].

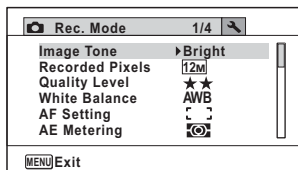

3 Press the four-way controller (▼) twice.

The frame moves to [Quality Level].

4 Press the four-way controller (▶).

A pull-down menu appears with the items that can be selected.

The pull-down menu displays only those items that can be selected with the current camera settings.

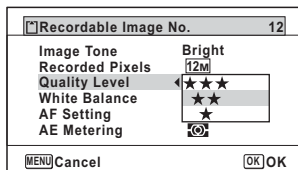

5 Use the four-way controller (▲▼) to change the setting.

The quality level changes each time the four-way controller (▲▼) is pressed.

6 Press the OK button or the four-way controller (◀).

The setting is saved and then the camera is ready for setting other functions.

To exit the settings, press the MENU button.

To use another operation, refer to the alternate step 6 options on the next page.

To Save the Setting and Start Taking Pictures

6 Press the shutter release button halfway.

The setting is saved and the camera returns to capture mode. When the shutter release button is pressed fully, the picture is taken.



When the [Setting] menu is displayed from mode, you can switch to mode by pressing the button.

To Save the Setting and Start Playback of Images

6 Press the button.

When the [Rec. Mode] menu is displayed from mode, the setting is saved and the camera returns to playback status.

To Cancel the Changes and Continue with Menu Operations

6 Press the MENU button.

The changes are canceled and the screen returns to step 3.



The **MENU** button function differs depending on the screen. Refer to the guide indications.



- | | |
|--------|---|
| Exit | Exits the menu and returns to the original screen. |
| | Returns to the previous screen with the current setting. |
| Cancel | Cancels the current selection, exits the menu and returns to the previous screen. |

Menu List

This displays the items that can be set with the menus and provides descriptions of each item. See the list of default settings in the Appendix “Default Settings” (p.295) to decide whether you want the settings saved when the camera is turned off and whether you want the settings returned to the defaults when the camera is reset.

[📷 Rec. Mode] Menu

This menu shows the functions related to taking still pictures and recording movies.

Item		Description	Page
Image Tone		For setting the tone of images	p.124
Recorded Pixels		For choosing the number of recorded pixels of still pictures	p.125
Quality Level		For setting the quality level of still pictures	p.127
White Balance		For adjusting the color balance according to the lighting conditions	p.128
AF Setting	Focusing Area	When AF (Standard),  (Macro), or  (1cm Macro) is selected as the focus mode, you can change the autofocus area (Focusing Area)	p.121
	Auto Macro	For choosing whether or not to use the auto macro function	p.122
	Focus Assist	For setting whether or not to use the focus assist light	p.123
AE Metering		For choosing the area of the screen that is metered to determine the exposure	p.130
Sensitivity		For setting the sensitivity	p.131
ISO Corction in AUTO		For setting the adjustment range when sensitivity is set to AUTO	p.132
EV Compensation		For adjusting the overall brightness of the picture	p.133
Movie	Recorded Pixels	For choosing the number of recorded pixels and the frame rate for movies	p.152
	Movie SR	For choosing whether or not to use the movie shake reduction function	p.153
	Interval Shoot	For recording multiple still pictures taken at a set interval as a movie file	p.154
D-Range Setting	Highlight Correction	For setting whether to perform bright portion compensation	p.134
	Shadow Correction	For setting whether to perform dark portion compensation	p.134
Pixel Track SR		For choosing whether to compensate for camera shake while taking still pictures	p.135
Interval Shoot		For setting the interval, number of pictures, and start time for taking pictures	p.136

Item	Description	Page
Blink Detection	For choosing whether to use the Blink Detection function with the Face Detection function	p.138
Digital Zoom	For choosing whether or not to use the digital zoom function	p.89
Instant Review	For choosing whether to display Instant Review	p.139
Memory	For choosing whether to save the set values of the shooting function or return to the defaults when the camera is turned off	p.158
Green Button	For assigning a function to the Green button in  mode	p.139
Sharpness	For choosing sharp or soft outlines	p.143
Saturation (Tone Adjustment)	For setting the color saturation. When [Monochrome] is selected, the item changes to [Tone Adjustment]	p.144
Contrast	For setting the image contrast level	p.145
Date Imprint	For choosing whether to imprint the date and/or time when taking still pictures	p.145
Macro Light	For setting whether or not to turn on the macro light for macro photography	p.146

● [📷 Rec. Mode] Menu 1

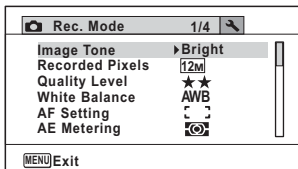

● [📷 Rec. Mode] Menu 2

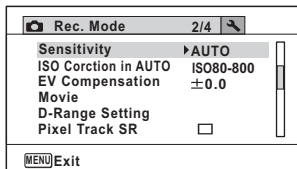

● [📷 Rec. Mode] Menu 3

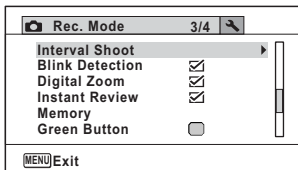

● [📷 Rec. Mode] Menu 4

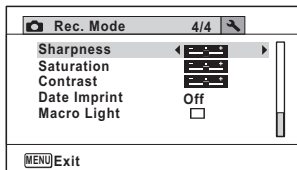

- Use the  (Green) mode to enjoy easy picture-taking using standard settings, regardless of the settings in the [📷 Rec. Mode] menu (p.86).
- Assigning frequently used functions to the Green button enables you to go straight to the desired function (p.139).

[Setting] Menu

Item	Description	Page
Sound	For adjusting the operation volume and playback volume, and setting the start-up sound, shutter sound, key operation sound, and self-timer sound	p.233
Date Adjustment	For adjusting the date and time	p.235
Alarm	For setting the alarm	p.237
World Time	For setting the hometown and destination	p.239
Text Size	For setting the text size of the menu	p.242
Language/言語	For setting the language in which menus and messages appear	p.243
Folder Name	For choosing how names are assigned to folders for storing images and sound files	p.244
USB Connection	For setting the method for connecting to a PC (MSC or PTP)	p.267
Video Out	For setting the output format to the AV equipment	p.246
HDMI Out	For setting the HDMI output format when connecting to an AV device with an HDMI terminal	p.247
Eye-Fi	For setting whether or not to use Eye-Fi communication	p.249
Brightness Level	For changing the brightness of the display	p.250
Power Saving	For setting the time until the camera enters power-saving mode	p.251
Auto Power Off	For setting the time until the camera turns off automatically	p.252
Quick Zoom	For choosing whether to use the Quick Zoom function (p.173) when playing back images	p.253
Guide Display	For setting whether to display explanations for selected items in Capture Mode Palette and Playback Mode Palette displays	p.254
Reset	For returning settings other than the date and time, language, world time and video out to their defaults	p.258
Delete All	For deleting all the images and sound files at once	p.179
Pixel Mapping	For correcting for defective pixels on the CCD sensor	p.255
Format	For formatting the SD Memory Card	p.232

● [Setting] Menu 1

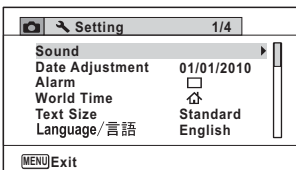

● [Setting] Menu 2

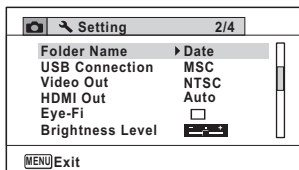

● [Setting] Menu 3

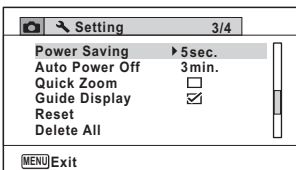

● [Setting] Menu 4

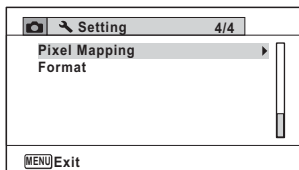

3 Taking Pictures

Taking Still Pictures	74
Setting the Shooting Functions	117
Taking Pictures Underwater	148
Recording Movies	150
Saving the Settings (Memory)	158

Taking Still Pictures

Taking Pictures

The Optio W90 is equipped with functions and shooting modes that support a wide array of scenes and subjects. This section explains shooting using the default settings when shipped.

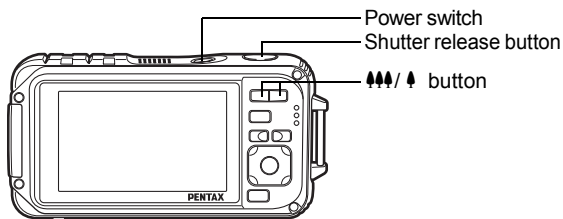

1 Press the power switch.

The camera turns on and is ready to take still pictures. In this manual, this is called Still Picture Capture mode.

2 Confirm the subject and shooting information on the display.

The focus frame in the middle of the display indicates the zone of automatic focusing.



Focus frame

When the camera detects a person's face, the Face Detection function is activated and the face detection frame appears (p.81).

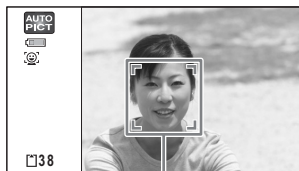

Face detection frame

You can change the captured area by pressing the zoom button (p.87).

Right (▲) Enlarges the subject.

Left (▼▼▼) Widens the area that is captured by the camera.

3

Press the shutter release button halfway.

The camera emits Focus Assist light in dark shooting situations.

The focus frame (or face detection frame) on the display turns green when the camera focuses on the subject at the correct distance.



4

Press the shutter release button fully.

The picture is taken.

The flash discharges automatically depending on the light conditions. The image appears on the display temporarily (Instant Review: p.77) and is saved to the SD Memory Card or the built-in memory.



Press the Green button to switch to the ● (Green) mode and let the camera set all the shooting functions automatically (p.86).

Using the Shutter Release Button

The shutter release button works in a two-step action as follows.

Press halfway

This refers to pressing the shutter release button gently to the first position. This locks the focus setting and the exposure. The green focus frame lights on the display when the shutter release button is pressed halfway and the subject is in focus. If the subject is out of focus, the frame turns white.

Press fully

This refers to pressing the shutter release button all the way down to the fully depressed position. This takes a picture.

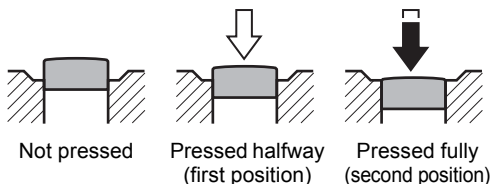

- Press the shutter release button gently when taking a picture to prevent camera shake.
- Practice pressing the shutter release button halfway/fully to learn where the first position and second position are.

Poor focusing conditions

The camera may not be able to focus under the following conditions. In these cases, lock the focus on an object the same distance away as the subject (by pressing and holding the shutter release button halfway), then aim the camera at your subject and press the shutter release button fully.

- Objects that lack contrast such as a blue sky or white wall
- Dark places or objects, or conditions that prevent light being reflected back
- Horizontal lines or intricate patterns
- Fast moving objects
- When there is an object in the foreground and an object in the background in the captured area
- Strongly reflected light or strong backlighting (bright background)

Instant Review and Blink Detection

The image appears on the display temporarily (Instant Review) immediately after it is captured. If the camera detects that the subject's eyes are closed while Face Detection (p.81) is activated, the message [Closed eyes have been detected] appears for 3 seconds (Blink Detection).



- When the Face Detection function does not work, Blink Detection also does not function. Even if the subject's faces are recognized, Blink Detection may not function depending on the condition of the recognized faces.
- You can also disable the Blink Detection function (p.138).

Setting the Shooting Mode

The Optio W90 has a variety of shooting modes that let you take pictures or record movies and sound in different situations simply by choosing the right mode for the particular situation from the Capture Mode Palette.

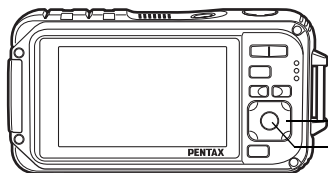

Four-way controller
OK button

- 1 Press the four-way controller (▼) in  mode.**

The Capture Mode Palette appears.

- 2 Use the four-way controller (▲▼◀▶) to choose a shooting mode.**

A guide of the selected shooting mode is displayed in the lower part of the display.



























- 3 Press the OK button.**

The shooting mode is selected and the camera returns to capture mode.











The following 24 modes can be selected with Capture Mode Palette.

Item	Description	Page
 Auto Picture	Automatically selects the best capture mode	p.83
 Program	Used for basic shooting. Various functions can also be set with this mode	p.85
 Night Scene	For night time images. Use of a tripod or other support is suggested	p.90
 Movie	For recording movies	p.150
 Underwater	For capturing images underwater	p.148
 Underwater Movie	Use this mode for taking underwater movies	p.148
 Landscape	For capturing landscape views. Enhances colors of sky and foliage	—
 Flower	For images of flowers. The outline of the flower is softened	—
 Portrait	For capturing portraits. Reproduces a healthy and bright skin tone	p.91
 Digital Microscope	Captures larger images of the small objects	p.99
 Digital Wide	Stitches two pictures together to create a wider image	p.111
 Digital SR	Higher sensitivity reduces blur	p.90
 Surf & Snow	For bright images such as sand or snow. Accurately meters for bright scenes	p.97
 Kids	For capturing moving kids. Reproduces a healthy and bright skin tone	p.93
 Pet	Automatically detects and captures a pet's full face	p.94
 Sport	For a fast moving subject. Tracks the subject until the picture is taken	p.97
 Fireworks	For capturing fireworks. Use of a tripod or other support is suggested	p.90
 Candlelight	For capturing scenes in candlelight	p.90
 Night Scene Portrait	For images of people at night. Use of a tripod or other support is advised	p.90
 Text	Captures text in an easy to read manner. Text contrast can be adjusted	p.98
 Food	For images of food and prepared dishes. Enhances saturation and contrast	—
 Digital Panorama	Stitches images taken with the camera to create a panoramic photograph	p.114

Item		Description	Page
	Frame Composite	For capturing images with a frame. Recorded pixels is fixed to 3M	p.101
	Report	For capturing image with fixed 1280×960 pixels for reports	—

* Green Mode (p.86) and Voice Recording (p.224) are available in addition to the ones noted above.



- In shooting modes other than  (Program),  (Night Scene),  (Movie),  (Digital Microscope),  (Digital SR),  (Digital Panorama),  (Digital Wide), and  (Frame Composite), saturation, contrast, sharpness, white balance, etc. are automatically set to the optimal settings for the selected mode.
- Some functions may not be available or may not function fully depending on the selected shooting mode. For details, refer to “Functions Available for Each Shooting Mode” (p.288).
- You can turn off the shooting mode guide on the Capture Mode Palette (p.254).

Using the Face Detection Function

When the camera detects a person's face in the image, the Face Detection function displays a yellow face detection frame around the face on the display screen, sets the focus (Face Detection AF) and compensates the exposure (Face Detection AE).

If the subject in the face detection frame moves, the frame also moves and changes size as it tracks the face.

The Face Detection function can recognize up to 32 people's faces. If it recognizes multiple faces, the camera displays a yellow frame over the main face and white frames over the other faces. It can display up to a total of 31 frames, including both the main and white frames.

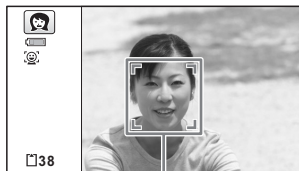

Face detection frame

When the multiple faces are detected



Main frame White frame



- Face Detection AF and AE may not work if the subject is wearing sunglasses, has part of their face covered or is not looking toward the camera.
- If the camera cannot detect the subject's face, the camera focuses using the setting currently selected in [Focusing Area].
- However, the Smile Capture function may not work and an image may not be captured, even when turned on, depending on the condition of the recognized faces, such as the faces being too small. If this happens, press the shutter release button to take a picture.
- In (Pet) mode, the Face Detection mode is switched to pet detection and the camera detects a registered pet's face.

To Switch the Face Detection Function

By default, the Face Detection function is set to Face Detection On. You can switch to the Smile Capture function, which automatically releases the shutter when your subject smiles. The Face Detection function is switched as follows each time the button is pressed:
Smile Capture → Face Detection Off → Face Detection On

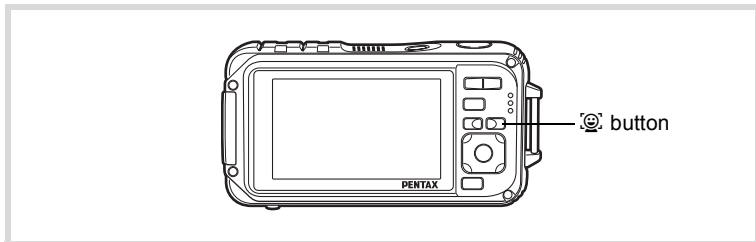

An icon indicating either Face Detection or Smile Capture appears on the display. (The Face Detection Off icon only appears right after the Face Detection function is switched to off.)

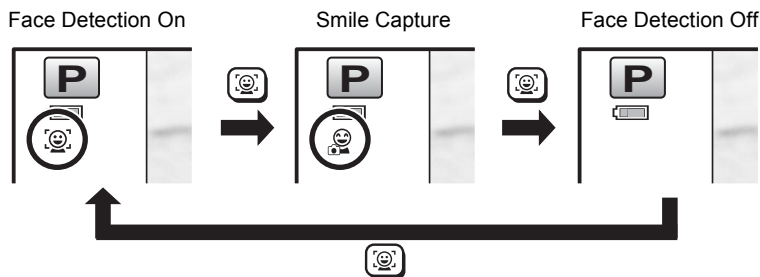

- The Face Detection function cannot be set to off in **AUTO PICT** (Auto Picture), (Night Scene Portrait), (Portrait), or (Kids). You can select either Face Detection On or Smile Capture in these modes.
- When Face Detection Off is selected, selecting (Green), **AUTO PICT** (Auto Picture), (Night Scene Portrait), (Movie), (Portrait), or (Kids) modes automatically switches to Face Detection On. When switching to another mode from one of these modes, the Face Detection setting returns to the previous setting.
- If you use the Face Detection function when the flash mode is set to (Auto), the flash mode automatically changes to (Flash On + Red-eye).

Taking Pictures Automatically (Auto Picture Mode)

In **AUTO PICT** (Auto Picture) mode, the camera automatically selects the most appropriate mode depending on the situations and subjects.

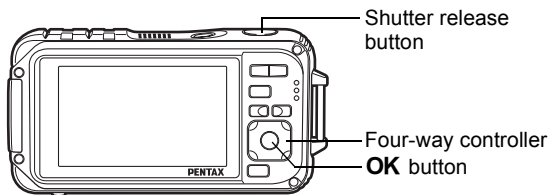

1 Press the four-way controller (▼) in **📷** mode.

The Capture Mode Palette appears.

2 Use the four-way controller (▲▼◀▶) to select **AUTO PICT** (Auto Picture).

3 Press the OK button.

Auto Picture mode is selected and the camera returns to capture mode. When the camera detects a person's face, the Face Detection function is activated and the face detection frame appears (p.81).



4 Press the shutter release button halfway.

The automatically selected capture mode appears on the top left of the display.

AUTO PICT 📷	Portrait	AUTO PICT 🌸	Flower	AUTO PICT 🕯️	Candlelight
AUTO PICT 🏞️	Landscape	AUTO PICT 🏃	Sport	AUTO PICT 😊	Others*
AUTO PICT 🌃	Night Scene	AUTO PICT 🌃📷	Night Scene Portrait		

The focus frame on the display turns green when the camera focuses on the subject at the correct distance.

* This mode is selected when the suitable shooting mode is not determined.

5

Press the shutter release button fully.

The picture is taken.



The following restrictions apply in mode:

- EV Compensation is unavailable.
- You cannot turn the Face Detection function off.
- The [Focusing Area] setting is fixed at [] (Multiple).
- Flower cannot be selected when using Digital Zoom or Intelligent Zoom.
- If Night Scene is selected when the flash mode is (Auto) or (Auto + Red-eye), the flash mode automatically changes to (Flash Off).
- If the (Night Scene Portrait) mode is selected when the flash mode is (Auto), the flash mode automatically changes to (Flash On + Red-eye) when the camera detects a face and determines that the flash is needed.

Setting the Functions (Program Mode)

In **P** (Program) mode, the shutter speed and the aperture are set automatically by the camera during shooting. However, you can select other functions such as the flash mode and recorded pixels.

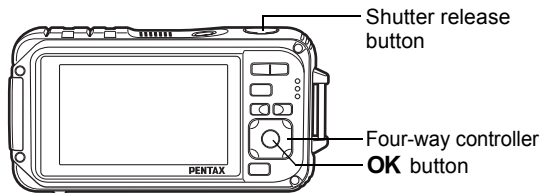

1 Press the four-way controller (▼) in **Q** mode.

The Capture Mode Palette appears.

2 Use the four-way controller (▲▼◀▶) to select **P** (Program).

3 Press the OK button.

Program mode is selected and the camera returns to capture mode. When the camera detects a person's face, the Face Detection function is activated and the face detection frame appears (p.81).



4 Set the functions you want to use.

Refer to "Setting the Shooting Functions" (p.117 - p.146) for details of how to set the functions.



5 Press the shutter release button halfway.







The focus frame on the display turns green when the camera focuses on the subject at the correct distance.

6 Press the shutter release button fully.

The picture is taken.



Taking Pictures in the Basic Mode (Green Mode)

In the  (Green) mode, you can enjoy easy picture-taking using standard settings, regardless of the settings in the [ Rec. Mode] menu.  mode settings are as shown below.

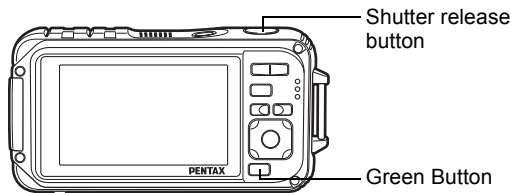
Flash Mode	 (Auto)	Quality Level	★★ (Better)
Drive Mode	<input type="checkbox"/> (Standard)	Highlight Correction	<input type="checkbox"/> (Off)
Focus Mode	AF (Standard)	Shadow Correction	<input type="checkbox"/> (Off)
Information Display	Standard	Sensitivity	AUTO (80-800)
Pixel Track SR	<input type="checkbox"/> (Off)	EV Compensation	±0.0
Recorded Pixels	 (4000×3000)	Blink Detection	<input checked="" type="checkbox"/> (On)
White Balance	AWB (Auto)	Digital Zoom	<input checked="" type="checkbox"/> (On)
Focusing Area	 (Multiple)	Instant Review	<input checked="" type="checkbox"/> (On)
Auto Macro	<input checked="" type="checkbox"/> (On)	Sharpness	 (Normal)
Focus Assist	<input checked="" type="checkbox"/> (On)	Saturation	 (Normal)
AE Metering	 (Multi-segment metering)	Contrast	 (Normal)
Image Tone	Bright	Date Imprint	Off
		Macro Light	<input type="checkbox"/> (Off)



1 Press the Green button in mode.

The camera switches to  mode. Press the Green button again to return to the status before  mode was selected.

When the camera detects a person's face, the Face Detection function is activated and the face detection frame appears (p.81).

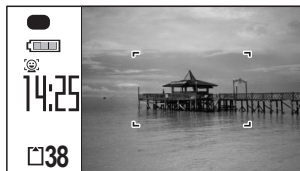

2 Press the shutter release button halfway.

The focus frame on the display turns green when the camera focuses on the subject at the correct distance.

3 Press the shutter release button fully.

The picture is taken.



- Assign mode to the [Green Button] on the [Rec. Mode] menu for using mode (p.140). (The default setting is mode).
- In mode, you cannot change the information on the display by pressing the **OK/DISPLAY** button.
- Press the **MENU** button in mode to display the [Setting] menu. The [Rec. Mode] menu cannot be displayed.
- When the camera is turned off in mode, it turns on in mode next time the power switch is pressed.

Using the Zoom

You can use the zoom to change the captured area.

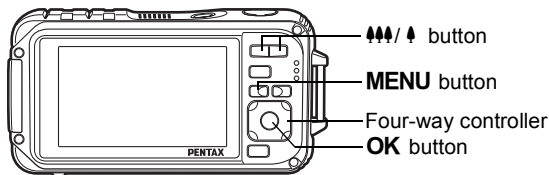

1 Press the button in mode.

Wide (left)

Widens the area that is captured by the camera.

Tele (right)

Enlarges the subject.

If you continue to press , the camera automatically switches from Optical Zoom to Intelligent Zoom and stops at the point where the zoom switches to Digital Zoom.

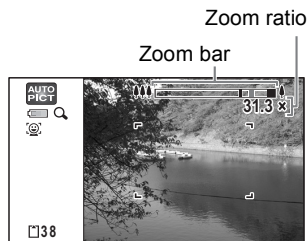

Once the button is released and pressed again, the camera switches to digital zoom.

If the Digital Zoom is set to off on the menu, the Optical Zoom and the Intelligent Zoom ranges are available for use. The zoom ratio of the intelligent zoom changes depending on the number of recorded pixels.

The zoom bar is displayed as follows.

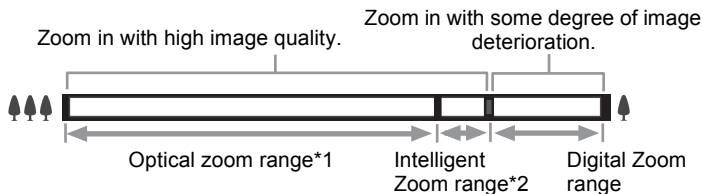

*1 You can zoom in to a maximum of 5× optically.

*2 The Intelligent Zoom range differs depending on the recorded pixels. See the following table.

Recorded pixels and the maximum zoom ratio

Recorded Pixels	Intelligent Zoom (The zoom ratio includes the 5× optical zoom.)	Digital Zoom
12M / 9M <small>1080</small>	Not Available (5× optical zoom only)	Equivalent to approx. 31.3×
7M / 5.3M <small>1080</small>	Approx. 6.5×	
5M / 3.8M <small>1080</small>	Approx. 7.7×	
3M	Approx. 9.8×	
2.1M <small>1080</small>	Approx. 10.4×	
1280	Not Available (5× optical zoom only)	Equivalent to approx. 31.3×
1024	Approx. 19.5×	
640	Approx. 31.3× (same as Digital Zoom)	



- We recommend you use a tripod to prevent camera shake when taking pictures at high zoom.
- Pictures taken in the digital zoom range appear grainier than pictures taken in the optical zoom range.
- Intelligent Zoom is not available under the following conditions:
When the number of recorded pixels is set to **12M** and **9M 16:9** (5× optical zoom available).
In (Green), (Movie), and (Underwater movie) mode
When the sensitivity is set to 3200 or 6400.
- Intelligent Zoom and Digital Zoom are not available in (Pet), (Digital SR), (Report), and (Burst Shooting) modes.
- The image enlarged using Intelligent Zoom may appear rough on the display. This does not affect the quality of the recorded image.
- Intelligent Zoom is available regardless of whether Digital Zoom is turned on or off.
- Digital Zoom is not available in (Digital Microscope) mode.
- Not every zooming function is available in **WIDE** (Digital Wide) mode.

To Set the Digital Zoom

The digital zoom is set to (On) in the default settings. To take pictures using only the optical zoom and Intelligent Zoom, set the digital zoom to (Off).

1 Press the MENU button in mode.

The [Rec. Mode] menu appears.

2 Use the four-way controller (▲▼) to select [Digital Zoom].

3 Use the four-way controller (◀▶) to switch between

- (On) or (Off).
- (On) Uses Digital Zoom
 - (Off) Uses only optical zoom and Intelligent Zoom

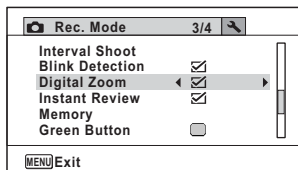

The setting is saved.





4 Press the MENU button.

The camera returns to capture mode.





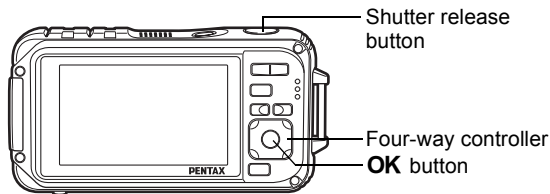

Saving the Digital Zoom Function setting p.158

Taking Pictures of Dark Scenes (Night Scene, Night Scene Portrait, Digital SR, Fireworks, and Candlelight Modes)

You can choose settings appropriate for taking pictures of dark scenes, such as nightscapes.

	Night Scene	For night time images. Use of a tripod or other support is suggested
	Night Scene Portrait	For images of people at night. Use of a tripod or other support is advised
	Digital SR	Higher sensitivity reduces blur
	Fireworks	For capturing fireworks. Use of a tripod or other support is suggested
	Candlelight	For capturing scenes in candlelight



- 1 Press the four-way controller (▼) in  mode.**
The Capture Mode Palette appears.
- 2 Use the four-way controller (▲▼◀▶) to select  (Night Scene),  (Night Scene Portrait),  (Digital SR),  (Fireworks), or  (Candlelight).**
- 3 Press the OK button.**
The shooting mode is selected and the camera returns to capture mode. When the camera recognizes a person's face, the Face Detection function is activated and the face detection frame appears (p.81).
- 4 Press the shutter release button halfway.**
The focus frame on the display turns green when the camera focuses on the subject at the correct distance.

Press the shutter release button fully.

The picture is taken.



- The shutter speed tends to be slower when taking pictures of dark scenes.
- To prevent the camera from shaking, set the Pixel Track SR (p.135) or use a tripod and/or the self-timer function (p.103).
- In (Digital SR) mode, the sensitivity is automatically set to AUTO, the [ISO Corction in AUTO] is set to 80-6400, and the number of recorded pixels is fixed at (2592×1944)/ (2592×1464).
- For (Fireworks) mode, the sensitivity is fixed at the minimum, the focus mode is (Infinity), and the flash mode is (Flash Off). Also, the shutter speed is set to 4 seconds and the aperture is fixed to open.
- Digital Zoom and Intelligent Zoom are not available in (Digital SR) mode.

Taking Pictures of People (Portrait Mode)

(Portrait) mode is suitable for taking pictures of people. It reproduces a healthy and bright skin tone. The Face Detection function (p.81) operates for the shooting mode, making it easier to emphasize the subject's face when taking pictures.

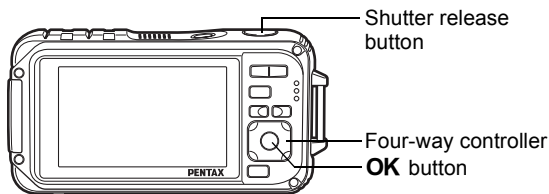

Press the four-way controller () in mode.

The Capture Mode Palette appears.

Use the four-way controller (, , ,) to select (Portrait).

3 Press the OK button.

The shooting mode is selected and the camera returns to capture mode. When the camera detects a person's face, the Face Detection function is activated and the face detection frame appears (p.81).

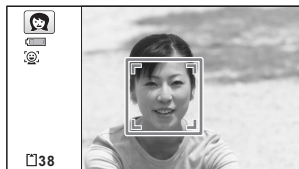
**4 Press the shutter release button halfway.**

The focus frame on the display turns green when the camera focuses on the subject at the correct distance.

5 Press the shutter release button fully.

The picture is taken.

Taking Pictures of Children (Kids Mode)

☺ (Kids) mode is suitable for taking pictures of moving children. It also reproduces healthy and bright skin tone. Face Detection function (p.81) operates automatically in ☺ mode, making it easier to emphasize the subject's face when taking pictures.

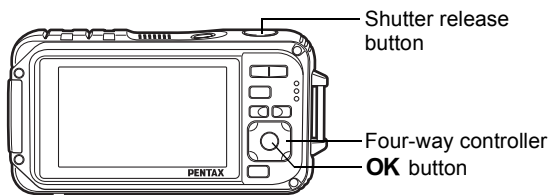

- 1 Press the four-way controller (▼) in  mode.**
The Capture Mode Palette appears.
- 2 Use the four-way controller (▲▼◀▶) to select ☺ (Kids).**

- 3 Press the OK button.**
Kids mode is selected and the camera returns to capture mode.
When the camera detects a person's face, the Face Detection function is activated and the face detection frame appears (p.81).





- 4 Press the shutter release button halfway.**
The focus frame on the display turns green when the camera focuses on the subject at the correct distance.
- 5 Press the shutter release button fully.**
The picture is taken.

Taking Pictures of Your Pet (Pet Mode)

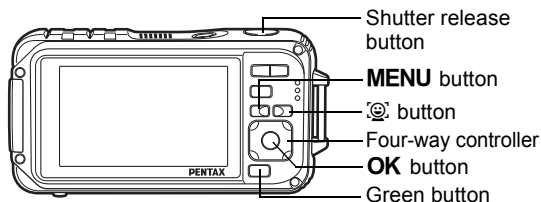
In  (Pet) mode, the camera automatically releases the shutter when a registered pet is detected. You can capture the color of your pet's coat.



- 1 Press the four-way controller (▼) in  mode.**
The Capture Mode Palette appears.
- 2 Use the four-way controller (▲▼◀▶) to select  (Pet).**

Press the OK button.

The pet registration screen appears. Aiming the camera at a pet's full face automatically releases the shutter and the pet registration confirmation screen appears. When you select [Registry] using four-way controller (▲) and press the **OK** button, the picture of the registered pet is indicated on the upper-left corner of the display and the camera returns to the capture status.

When the camera detects the pet's face, the camera automatically releases the shutter.

You can also take a picture by pressing the shutter release button.

When you press the  button twice in the capture status screen, the pet registration screen appears to register another pet. You can register up to three pets.



Pet registration screen





Registry confirmation screen





Capture status screen



- When you press the **MENU** button on the pet registration screen, the registration will be canceled and the camera returns to the still picture capture mode. However, the camera will not release the shutter automatically when it detects a pet's face if no pets are registered.
- Only dogs and cats can be registered using the Pet Detection function. Other animals or human faces cannot be registered. You may not be able to register a pet's face if, for example, the pet's face is too small.
- The camera may not detect the registered pet's face, depending on the shooting situation.
- Digital Zoom and Intelligent Zoom are not available in  (Pet) mode.
- You cannot turn off the LCD or change the display to "Simple Display + Subscreen" by pressing the **OK/DISPLAY** button in  (Pet) mode.

To Switch the Pet You Want to Shoot

If you have registered two or three pets, choose the pet you want to detect.



- 1 Press the  button on the capture status screen in  (Pet) mode.
The pet registration screen appears.



- 2 Use the four-way controller (◀▶) to select the pet you want to detect.
- 3 Press the OK button.

The selected pet is switched to the pet you want to detect and the camera returns to capture status.

To Delete the Pet from the Entry

- 1 Press the  button on the capture status screen in  (Pet) mode.
The pet registration screen appears.

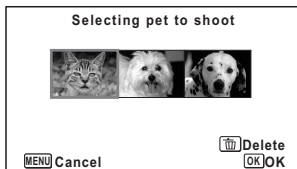

- 2 Use the four-way controller (◀▶) to select the pet you want to delete.
- 3 Press the Green button.
- 4 Use the four-way controller (▲) to select [Delete].
- 5 Press the OK button.
The selected pet is deleted.



- [Focusing Area] is set to (Automatic Tracking AF) and the flash mode is set to (Flash Off). However, you can change these settings.
- [Focus Assist] is set to off. However, you can change this setting.

Taking Pictures of Sports and Leisure Activities (Surf & Snow/Sport Mode)

	Surf & Snow	For bright images such as sand or snow. Accurately meters for bright scenes
	Sport	For a fast moving subject. Tracks the subject until the picture is taken

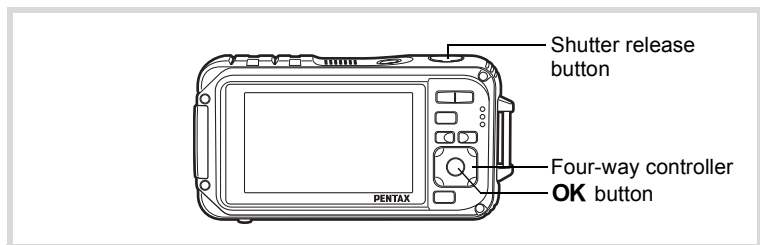

- 1 Press the four-way controller (▼) in mode.**
The Capture Mode Palette appears.
- 2 Use the four-way controller (▲▼◀▶) to select (Surf & Snow) or (Sport).**
- 3 Press the OK button.**
The shooting mode is selected and the camera returns to capture mode.
When the camera detects a person's face, the Face Detection function is activated and the face detection frame appears (p.81).

4 Press the shutter release button halfway.

The focus frame on the display turns green when the camera focuses on the subject at the correct distance. When the Sport mode is selected, the focus frame follows the subject while the shutter release button is pressed halfway.

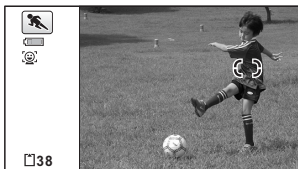

5 Press the shutter release button fully.

The picture is taken.

Taking Pictures of Text (Text Mode)

Take crisp and easy-to-read pictures of text. It is useful for taking pictures of and saving important documents, and when the text is too small and difficult to read.

	Color	A picture of the text is taken in its original color.
	Reversed Color	The colors are reversed.
	B&W	A picture of the text is taken in black and white.
	Negative	Black and white are reversed.

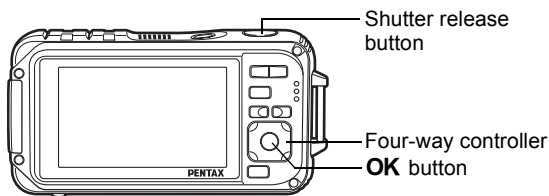

1 Press the four-way controller (▼) in mode.

The Capture Mode Palette appears.

2 Use the four-way controller (▲▼◀▶) to select (Text).

3 Press the OK button.

The text mode selection screen appears.

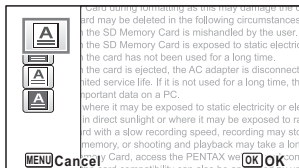

4 Use the four-way controller (▲▼) to select ▲, ■, ●, or □.

5 Press the OK button.

The selected icon appears and the camera returns to capture status.

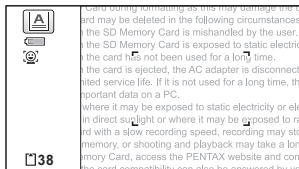

6 Press the shutter release button halfway.

The focus frame on the display turns green when the camera focuses on the subject at the correct distance.





7 Press the shutter release button fully.

The picture is taken.

Taking Pictures in Digital Microscope Mode

In the Digital Microscope mode, you can take pictures of objects as close as 1 cm, also because the 3 macro lights around the lens are always lighted, you can take minute pictures of text, the veins of leaves, or specimens of tiny insects etc.



- The number of recorded pixels is fixed at **2.1M** (1920×1080).
- The focus mode is fixed at  (1cm Macro).
-  (Continuous Shooting) /  (Burst Shooting) /  (Auto Bracket) cannot be selected.
- The flash does not discharge in this mode.
- The Face Detection function and the blink detection function are turned off.
- You can change the information display only between the normal and No Info displays.
- The illumination of the macro lights may be uneven or insufficient depending on the shooting conditions.

1 Press four-way controller (▼) in  mode.

2 Use the four-way controller (▲▼◀▶) to select  (Digital Microscope).

3 Press the OK button.

 (Digital Microscope) mode is selected and the camera returns to capture mode.

Card may be deleted in the following circumstances:
 on the memory card is mishandled by the user.
 on the card has not been used for a long time.
 on the card is ejected, the AC adapter is disconnected
 limited service life. If it is not used for a long time, the
 important data on a PC.
 d where it may be exposed to static electricity or elec
 d in direct sunlight or where it may be exposed to rap
 ard with a slow recording speed, recording may stop
 e n 38y, or shooting and playback may take a long

4 Press the  /  button.

If you press , the camera enlarges the subject.

 Wide (left)

Widens the area that is captured by the camera.

 Tele (right)

Enlarges the subject.

not used for a lo
 is selected, the AC adapter
 3.8 x
 vice life. If it is not used for
 data on a PC.
 may be exposed to static e
 sunlight or where it may be

5 Press the shutter release button halfway.

The focus frame on the display turns green at the position where the camera focuses on the subject.



6 Press the shutter release button fully.

The picture is taken.

Framing Your Pictures (Frame Composite Mode)

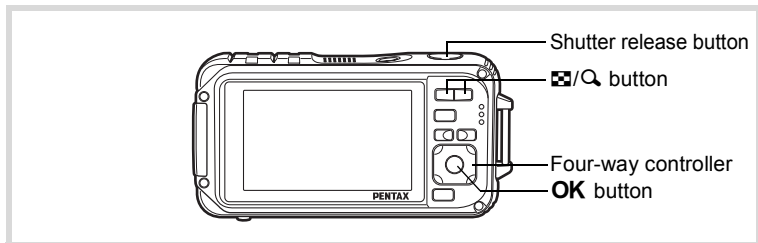
In  (Frame Composite) mode, you can take pictures using the frames stored in the camera.



- 1 Press the four-way controller (▼) in  mode.**
The Capture Mode Palette appears.
- 2 Use the four-way controller (▲▼◀▶) to select  (Frame Composite).**
- 3 Press the OK button.**
The 12-frame display of the frame selection screen appears.
- 4 Use the four-way controller (▲▼◀▶) to choose the frame you want to use.**



- 5 Press the  button.**
The selected frame appears in single-image display.
You can choose another frame using either of the following operations.

Four-way controller (◀▶)	Press to choose a different frame.
Zoom button ()	Press to return to the 12-frame display of the frame selection screen, and then perform step 4 to choose a different frame.

6 Press the OK button.

The frame appears on the display. When the camera detects a person's face, the Face Detection function is activated and the face detection frame appears (p.81).

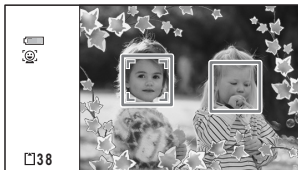
**7 Press the shutter release button halfway.**

The focus frame on the display turns green when the camera focuses on the subject at the correct distance.

8 Press the shutter release button fully.

The picture is taken.



- The number of recorded pixels is fixed at **[3M]** (2048×1536)/**2.1M** (1920×1080).
- You cannot turn off the LCD or change the display to “Simple Display + Subscreen” by pressing the **OK/DISPLAY** button in **[C]** (Frame composite) mode.
- At shipment, the camera includes 3 default frames and 42 optional frames for each aspect ratio (4:3 and 16:9). (The CD-ROM supplied with the camera contains a total of 90 frames, including the default frames.)

Optional Frames



The optional frames are stored in the built-in memory in the Optio W90. These optional frames are deleted if the files on the built-in memory are deleted with a computer or the built-in memory is formatted. To reload the optional frames into the built-in memory, copy the files from the CD-ROM (S-SW102) supplied with the camera (p.208).

Adding a Frame to a captured image p.206





Using the Self-timer

In Self-timer mode, the picture is taken ten seconds or two seconds after the shutter release button is pressed.

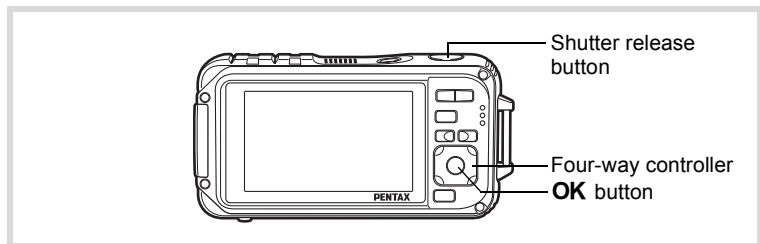
Stabilize the camera with a tripod or other support when taking a picture with the self-timer.

	Use this mode when you want to be included in a group picture. The picture is taken approximately ten seconds after the shutter release button is pressed.
	Use this mode to avoid camera shake. The picture is taken approximately two seconds after the shutter release button is pressed.



- 1 Press the four-way controller (▲) in  mode.**
The [Drive Mode] screen appears.
- 2 Use the four-way controller (◀▶) to select  and press the four-way controller (▼).**
- 3 Use the four-way controller (◀▶) to select  or  and press the OK button.**
The camera is ready to take the picture using the self-timer.
When the camera detects a person's face, the Face Detection function is activated and the face detection frame appears (p.81).
- 4 Press the shutter release button halfway.**
The focus frame on the display turns green when the camera focuses on the subject at the correct distance.

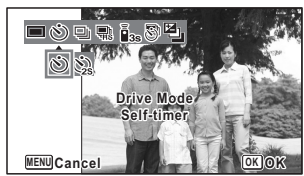

5

Press the shutter release button fully.

The picture is taken ten seconds or two seconds later.



Focusing may be compromised if you move the camera while the self-timer lamp is blinking when taking still pictures.



- In (Movie) mode, recording will start after ten seconds (or two seconds).
- Press the shutter release button halfway while the self-timer is engaged to stop the countdown and press fully to restart the countdown.
- cannot be selected while (Green) mode is in default setting. Select in another shooting mode and then switch the shooting mode to .
- The self-timer lamp does not flash in (Pet) mode.

3

Taking a Series of Pictures (Continuous Shooting/Burst Shooting)

Pictures are taken continuously as long as the shutter release button is pressed.

	Continuous Shooting	Each time a picture is taken, the image is saved in the memory before the next image is taken. The higher the image quality, the longer the interval between shots.
	Burst Shooting	The number of recorded pixels is fixed at 5M (2592×1944)/ 3.8M (2592×1464) and the interval between shots is shorter than “Continuous Shooting”.

* The number of images that can be shot continuously and the interval between shots depend on shooting situations.

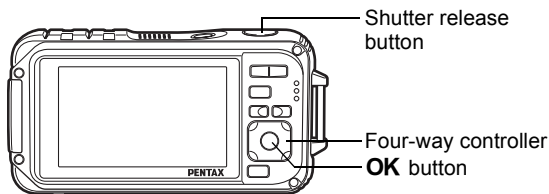

1

Press the four-way controller (▲) in mode.

The [Drive Mode] screen appears.

2 Use the four-way controller (◀▶) to select or and press the OK button.

The camera is ready for continuous shooting and burst shooting.

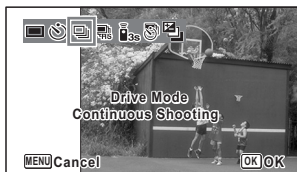















3 Press the shutter release button halfway.

The focus frame on the display turns green when the camera focuses on the subject at the correct distance.









4 Press the shutter release button fully.

Pictures are taken continuously as long as you keep the shutter release button pressed.





- The flash does not discharge in  and  modes.
-  and  cannot be selected in  (Green),  (Auto Picture),  (Digital Microscope),  (Night Scene),  (Movie),  (Underwater Movie),  (Fireworks),  (Frame Composite),  (Digital Wide) or  (Digital Panorama) modes.
- Digital Zoom and Intelligent Zoom are unavailable when the sensitivity is set to 3200 and higher.
- Digital Zoom and Intelligent Zoom are not available in  mode.



- With , you can continue shooting until the memory capacity of the SD Memory Card or built-in memory is full.
- The interval of  varies according to the [Recorded Pixels] and [Quality Level] settings.
- The focus, exposure and white balance are locked with the first shot.
- When the Face Detection function is activated (p.81), it works only when taking the first shot.
- The Blink Detection function works only for the last shot.
- The number of recorded pixels is fixed at  /  in  and  modes. When the shooting mode is set to  (Report), the number of recorded pixels is set to  (1280×960).

Taking Pictures Using the Remote Control Unit (Optional)





You can use the remote control (optional) to take pictures while you are away from the camera.

 3-sec Remote Control	The shutter will be released after about three seconds when the shutter release button on the remote control unit is pressed.
 0-sec Remote Control	The shutter will be released immediately when the shutter release button on the remote control unit is pressed.

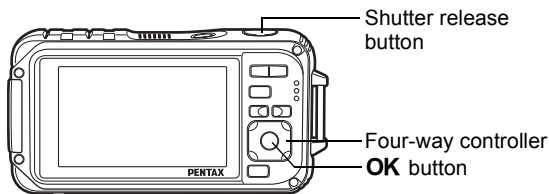
3

Taking Pictures



- 1 Press the four-way controller (▲) in  mode.**
The [Drive Mode] screen appears.
- 2 Use the four-way controller (◀▶) to select  and press the four-way controller (▼).**
- 3 Use the four-way controller (◀▶) to select  or  and press the OK button.**
The self-timer lamp begins to blink slowly and be ready to take a picture by the remote control.
When the camera detects a person's face, the Face Detection function is activated and the face detection frame appears (p.81).

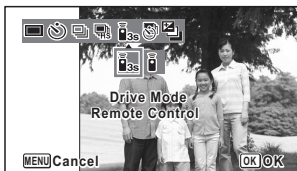

4 Point the remote control at the remote control receiver and press the shutter release button on the remote control.

The focus frame turns green when the subject is in focus and the camera takes a picture at the following timing.





When  (3-sec Remote Control) is selected:

The self-timer lamp blinks quickly and the camera takes a picture after about three seconds.

When  (0-sec Remote Control) is selected:

The camera takes a picture immediately.



- The operating range is approx. 4 m (13 ft) from the front of the camera when using the remote control unit.
- In  (Movie) mode, pressing the shutter release button again stops the recording.
- The camera takes a picture even if the focus is not achieved.
- If the shutter release button is pressed halfway during the countdown, the countdown stops. If the shutter release button is pressed fully, the camera starts the countdown again.
-  /  cannot be selected in  (Green) mode.
- The self-timer lamp does not flash in  (Pet) mode.

Taking Pictures at a Set Interval (Interval Shoot)

In this mode, a set number of pictures can be taken automatically at a set interval from a set time.

Interval	10 sec. – 99 min.	Set the camera to take pictures at intervals. The intervals can be set in increments of one second from ten seconds to 4 minutes, or in 1 minute increments from 4 to 99 minutes. You cannot set the camera to take interval shots at less than ten seconds.
Number of Shots	2 shots – number of recordable images	You can set this to up to 1000 shots. However, it cannot exceed the number of recordable images.
Start Delay	0 min. – 24 hours	You can set 1 minute increments for the first 59 minutes and 1 hour increments from there. If the start time is set to 0 minutes, the first picture is taken as soon as the shutter release button is pressed.

1 Press the four-way controller (▲) in mode.

The [Drive Mode] screen appears.

2 Use the four-way controller (◀▶) to select (Interval Shoot) and press the OK button.

The current interval shoot settings appear for approximately 1 minute. To take pictures with the current settings, go to step 10.

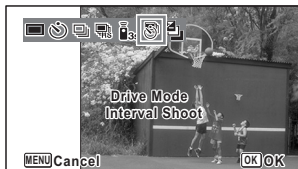

3 Press the OK button while the settings are displayed.

The [Interval Shoot] setting screen appears. [Interval] is marked with the frame.

4 Set the interval.

1 Press the four-way controller (▶).

2 Use the four-way controller (▲▼) to set the minutes, then press the four-way controller (▶).

3 Use the four-way controller (▲▼) to set the seconds, then press the four-way controller (▶).

The frame returns to [Interval].

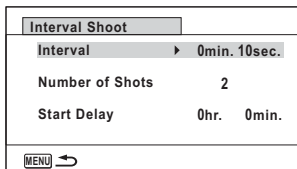

5 Press the four-way controller (▼).

The frame moves to [Number of Shots].

6 Set the number of shots.

- 1 Press the four-way controller (▶).
- 2 Use the four-way controller (▲▼) to set [Number of Shots], then press the four-way controller (▶).
The frame returns to [Number of Shots].

7 Press the four-way controller (▼).

The frame moves to [Start Delay].

8 Set the start delay.

- 1 Press the four-way controller (▶).
- 2 Use the four-way controller (▲▼) to set the hours, then press the four-way controller (▶).
- 3 Use the four-way controller (▲▼) to set the minutes, then press the four-way controller (▶).
The frame returns to [Start Delay].

9 Press the MENU button.

The [Interval Shoot] settings are saved and the camera returns to capture mode.

10 Press the shutter release button halfway.

The focus frame on the display turns green if the subject is in focus.

11 Press the shutter release button fully.

Interval shooting starts.

The LCD turns off between shots (during standby). Press the power switch during standby to display the remaining number of shots and interval on the monitor.

The [Stop interval shooting?] message is displayed when the power switch and then the **MENU** button are pressed during standby. Pressing the **OK** button cancels interval shooting.



- Interval Shoot is unavailable in **AUTO** (Auto Picture), **GREEN** (Green), **DIGITAL PANORAMA** (Digital Panorama), **WIDE** (Digital Wide), **FIREWORKS** (Fireworks) and **VOICE RECORDING** (Voice Recording) modes.
- Even if an alarm is set, the alarm will not ring during interval shooting.
- Interval Shoot stops if the SD Memory Card is removed or inserted during standby.



The Interval Shoot settings can also be configured from the [Rec. Mode] menu. (p.136)

Taking Pictures with Automatic Exposure Adjustment (Auto Bracket)

Press the shutter release button once to automatically adjust the exposure and take three pictures in succession. After taking the pictures, you can select the best one.

The shooting order is best exposure → -1.0 EV → +1.0 EV.

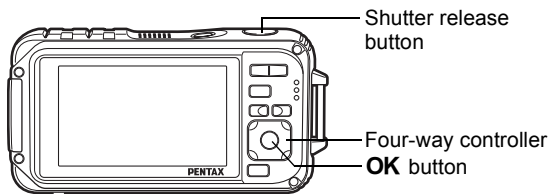

1 Press the four-way controller (▲) in mode.

The [Drive Mode] screen appears.

2 Use the four-way controller (◀▶) to select (Auto Bracket) and press the OK button.

The camera is now ready to take pictures with Auto Bracket.

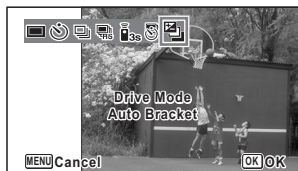

3 Press the shutter release button halfway.

The focus frame on the display turns green if the subject is in focus.

4 Press the shutter release button fully.

Press the shutter release button once to automatically adjust the exposure and take the three pictures at different exposures.



- When the Instant Review is set to on (p.139), the pictures taken are shown in Instant Review after shooting (p.77).
- Auto Bracket is unavailable in (Movie), (Underwater Movie), (Auto Picture), (Digital Microscope), (Green), (Fireworks), (Digital Panorama), (Digital Wide), (Frame Composite) and (Voice Recording) modes.

Using the Digital Wide Function (Digital Wide Mode)

In **WIDE** (Digital Wide) mode, you can stitch two vertical images captured with this camera into a single frame up to approx. 21 mm coverage (35 mm film equivalent).

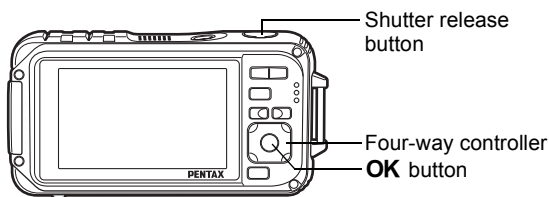

- 1 Press the four-way controller (▼) in  mode.**
The Capture Mode Palette appears.
- 2 Use the four-way controller (▲▼◀▶) to select **WIDE** (Digital Wide).**

3 Press the OK button.

The camera enters the **WIDE** mode.

Turn the camera 90° clockwise and align your first picture.

When the camera detects a person's face, the Face Detection function is activated and the face detection frame appears (p.81).



4 Press the shutter release button halfway.

The focus frame on the display turns green when the camera focuses on the subject at the correct distance.

5 Press the shutter release button fully.

The first captured image is temporarily saved, and the shooting screen for the second image is displayed.

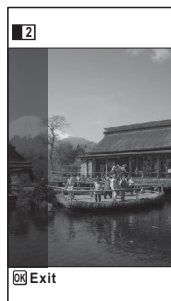

6 Take the second image.

Overlap the image on the preview guide on the left of the screen to compose the second image. Repeat steps 4 and 5 to take the second image. This combines first and second images.

The stitched first and second image appears on the display temporarily (Instant Review), and then is saved.



- To minimize distortion when taking the second image, turn the camera so that it pivots around the right edge of the preview guide on the screen.
- Some distortion may result from moving objects, repeating patterns, or if nothing exists when overlapping the first and second image on the preview guide.
- When the Face Detection function is activated (p.81), it works only when taking the first shot.
- The number of recorded pixels for images captured with **WIDE** mode is fixed at **5M** (2592×1944).
- (1cm Macro) is unavailable in **WIDE** mode.
- You cannot change the information on the display by pressing the **OK/ DISPLAY** button in **WIDE** (Digital Wide) mode.

To Cancel after Taking the First Shot

1 When the shooting screen for the second image is displayed in step 5 on p.112, press the **OK** button or the four-way controller (▼).

A confirmation dialog appears.

2 Use the four-way controller (▲▼) to select an option and press the **OK** button.

Save	Saves the first image and you can retake the first shot. The first image is saved at 3M (2048×1536).
Discard	Discards the first image and you can retake the first shot.
Cancel	Returns to the shooting screen for the second image.

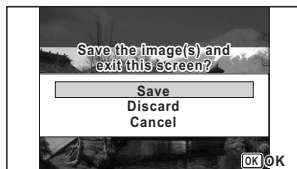

Taking Panoramic Pictures (Digital Panorama Mode)

In **■** (Digital Panorama) mode, you can stitch together two or three captured frames to create a panoramic photograph with the camera.

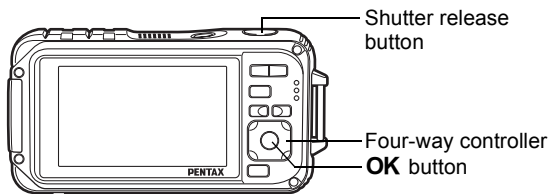

- 1 Press the four-way controller (▼) in **☰** mode.**

The Capture Mode Palette appears.

- 2 Use the four-way controller (▲▼◀▶) to select **■** (Digital Panorama).**

- 3 Press the OK button.**

The camera enters the **■** mode and the message [Set shift direction] is displayed.

- 4 Use the four-way controller (◀▶) to choose the direction in which the images will be joined.**

The screen for taking the first frame is displayed.



When the camera detects a person's face, the Face Detection function is activated and the face detection frame appears (p.81).



5 Press the shutter release button halfway.

The focus frame on the display turns green when the camera focuses on the subject at the correct distance.

6 Press the shutter release button fully.

The screen for taking the second frame is displayed after you take the first frame.

If you select right (▶) in step 4:

The right edge of the first frame appears in semi-transparent form on the left edge of the display.

If you select left (◀) in step 4:

The left edge of the first frame appears in semi-transparent form on the right edge of the display.

7 Take the second frame.

Move the camera so that the semi-transparent image and the actual view overlap and press the shutter release button.

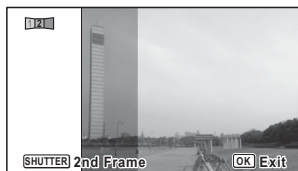

8 Take the third frame.

Repeat steps 5 to 7 to take the third frame.

The panorama images are joined and a stitched together image appears.

The stitched together image does not appear when [Instant Review] (p.139) is off.



- Some distortion may result from moving objects, repeating patterns, or if nothing exists when overlapping the first and second frames or the second and third frames on the preview guide.
- When the Face Detection function is activated (p.81), it works only when taking the first shot.
- You cannot turn off the LCD or change the display to “Simple Display + Subscreen” by pressing the **OK/DISPLAY** button in ■■■ (Digital Panorama) mode.

To Cancel after Taking the First or Second Frame

- 1 After shooting the first frame in step 6 on p.115 or the second frame in step 7, press the **OK** button or the four-way controller (**▼**).

A confirmation dialog appears.

- 2 Use the four-way controller (**▲▼**) to select an option and press the **OK** button.

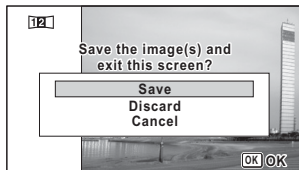

Save	Saves the captured image(s) and you can retake the first frame. When this option is selected after shooting the second frame, the first and the second frames are stitched together and saved as a panoramic photograph.
Discard	Discards the captured image(s) and you can retake the first frame.
Cancel	Returns to the previous shooting screen.



Unstitched images shot in **■■■** mode are fixed at **2M** (1600×1200).

Setting the Shooting Functions

Selecting the Flash Mode

	Auto	The flash discharges automatically depending on the light conditions.
	Flash Off	The flash does not discharge, regardless of the brightness. Use this mode to take pictures where flash photography is prohibited.
	Flash On	The flash discharges regardless of the brightness.
	Auto + Red-eye	This mode reduces the phenomenon of red eyes caused by the light from the flash being reflected in the subject's eyes. The flash discharges automatically.
	Flash On + Red-eye	This mode reduces the phenomenon of red eyes caused by the light from the flash being reflected in the subject's eyes. The flash discharges regardless of the light conditions.
	Soft Flash	This mode reduces the intensity of the flash so that the flash is not too bright even when fired at close range. The flash discharges regardless of the light conditions.



- The flash mode is fixed at in the following situations:
 - When (Movie), (Underwater Movie), (Digital Microscope), or (Fireworks) is selected as the capture mode.
 - When (Continuous Shooting), (Burst Shooting), or (Auto Bracket) is selected as the Drive Mode.
 - When (Infinity) is selected as the focus mode.
- In (Green) mode, you can only select or .
- In (Night Scene) mode, you cannot select and .
- If you use the Face Detection function when is selected, the mode is automatically set to .
- A pre-flash discharges when using the red-eye reduction function.



Using the flash when capturing images at a close distance may cause irregularities in the image due to the light distribution.

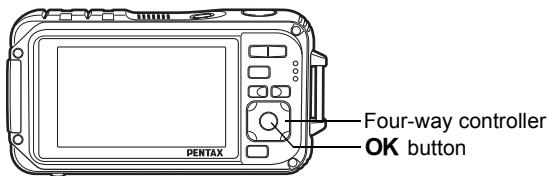

3

1 Press the four-way controller (◀) in mode.

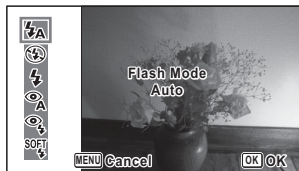

The [Flash Mode] screen appears. The flash mode changes each time the button is pressed. You can also change the setting using the four-way controller (▲▼).



2 Press the OK button.

The setting is saved and the camera returns to capture mode.





About the red-eye phenomenon

Taking pictures using the flash may cause the subject's eyes to appear red in the resulting picture. This phenomenon occurs when the light from the flash is reflected in the subject's eyes. It can be reduced by illuminating the area around the subject or moving closer to the subject and zooming out to a wider angle. Setting the flash mode to  (Auto + Red-eye) or  (Flash On + Red-eye) is also an effective way of reducing red eyes.

If the subject's eyes appear red despite such precautions, they can be corrected by the red-eye compensation function (p.205).

Saving the Flash Mode setting  p.158

Selecting the Focus Mode

AF	Standard	This mode is used when the distance to the subject is from 50 cm to ∞ . The camera is focused on the subject in the autofocus area when the shutter release button is pressed halfway.
	Macro	This mode is used when the distance to the subject is from 10 cm to 60 cm. The camera is focused on the subject in the autofocus area when the shutter release button is pressed halfway.
	1cm Macro	This mode is used when the distance to the subject is from 1 cm to 30 cm. The camera is focused on the subject in the autofocus area when the shutter release button is pressed halfway.
PF	Pan Focus	This mode is used when you ask someone to take pictures for you, or when taking pictures of the scenery through the window of a car or train. The entire picture, from the front to the back, is focused.
	Infinity	This mode is used for taking distant objects. The flash is set to  (Flash Off).
MF	Manual Focus	This mode lets you adjust the focus manually.

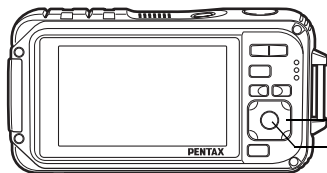

Four-way controller
OK button

1 Press the four-way controller (▶) in mode.

The [Focus Mode] screen appears. The focus mode changes each time the button is pressed. You can also change the setting using the four-way controller (▲▼).

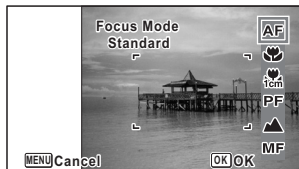

2 Press the OK button.

The setting is saved and the camera returns to capture mode.



- In **AF** (Green) mode, you can only select **AF**, **MF**, or **PF**.
- **1cm Macro** is unavailable in **WIDE** (Digital Wide) mode.
- The focus mode is fixed at **MF** in **Fireworks** mode.
- The noise from focusing is recorded when a focus mode other than **PF** or **MF** is selected in **Movie** and **Underwater Movie** modes.
- When [Auto Macro] is on and shooting with **MF** selected, if the subject is further than 60 cm away, the camera automatically focuses to ∞ (Infinity).

Saving the Focus Mode setting p.158

3

To Set the Manual Focus

The procedure for setting the focus manually (**MF**) is described below.

1 Press the four-way controller (▶) in **AF** mode.

The [Focus Mode] screen appears.

2 Use the four-way controller (▶) to select **MF**.

3 Press the OK button.

The central portion of the image is magnified to full screen on the display.

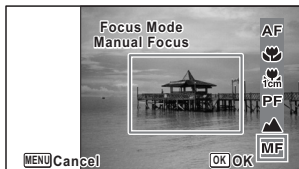

4 Press the four-way controller (▲▼).

The **MF** indicator appears on the display to indicate the approximate distance to the subject. Use the four-way controller (▲▼) to adjust the focus using the indicator as a guide.

- ▲ for distant focus
- ▼ for closer focus



MF indicator

5 Press the OK button.

The focus is fixed and the camera returns to capture mode. After the focus is fixed, you can press the four-way controller (▶) again to display the **MF** indicator and readjust the focus.



The shooting mode and drive mode cannot be changed while the **MF** indicator is displayed.



To switch from **MF** to another focus mode, press the four-way controller (▶) while the **MF** indicator is displayed.

Changing the Focusing Area (AF area)

You can change the autofocus area (Focusing Area).

	Multiple	Normal autofocus area
	Spot	The autofocus area becomes smaller.
	Automatic Tracking AF	Keeps moving subjects in focus.

- 1** Press the **MENU** button in mode.
The [Rec. Mode] menu appears.
 - 2** Use the four-way controller (▲▼) to select [**AF Setting**].
 - 3** Press the four-way controller (▶).
The [AF Setting] screen appears.
 - 4** Use the four-way controller (▲▼) to select [**Focusing Area**].
 - 5** Press the four-way controller (▶).
A pull-down menu appears.
- AF Setting

Focusing Area ◀

Auto Macro

Focus Assist

Cancel OK
- 6** Use the four-way controller (▲▼) to change the **Focusing Area**.
 - 7** Press the **OK** button.
The setting is saved.

8 Press the MENU button twice.

The camera returns to capture mode.



- In (Movie), (Underwater Movie), and (Frame Composite) modes, cannot be selected.
- In (Fireworks), (Green) and (Auto Picture) modes, the focusing area is fixed at [] .

Setting the Auto Macro

3

Taking Pictures

When [Auto Macro] is on, the focus is adjusted to the macro range (distance to the subject is 10 cm to 60 cm) as necessary, even if the focus mode setting is AF (Standard).

When it is off and the focus mode is set to Standard (**AF**), the AF operates only in the standard range, and focusing is not done in the macro range. When the focus mode is set to Macro or 1cm Macro, the focus is only adjusted in the respective macro range and is not done in the standard range.

1 Press the MENU button in mode.

The [Rec. Mode] menu appears.

2 Use the four-way controller () to select [AF Setting].

3 Press the four-way controller ().

The [AF Setting] screen appears.

4 Use the four-way controller () to select [Auto Macro].

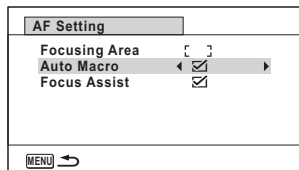

5 Use the four-way controller () to select [(On)/ (Off)].

The setting is saved.

6 Press the MENU button twice.

The camera returns to capture mode.

Setting the AF Assist Light (Focus Assist)

The camera automatically emits the Focus assist light in dark shooting situations. You can set the light to on or off.

1 Press the MENU button in mode.

The [ Rec. Mode] menu appears.

2 Use the four-way controller () to select [AF Setting].

3 Press the four-way controller () .

The [AF Setting] screen appears.

4 Use the four-way controller () to select [Focus Assist].

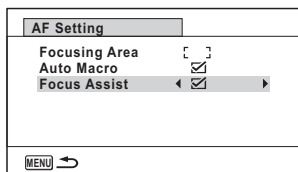

5 Use the four-way controller () to select [(On)/ (Off)].

The setting is saved.

6 Press the MENU button twice.





The camera returns to capture mode.



Looking at the light directly will not create a safety hazard. However, do not look into the emitter from a very short distance since you may feel dazzled.



The camera does not emit the Focus Assist light under the following conditions.

- In  (Movie),  (Underwater Movie) or  (Fireworks) mode
- When the focus mode is set to **PF** (Pan Focus),  (Infinity) or **MF** (Manual Focus).

Setting the Image Tone

For setting the tone of images.

You can select from [Bright], [Natural], or [Monochrome].

The default setting is [Bright].

1 Press the **MENU** button in mode.

The [ Rec. Mode] menu appears.

2 Use the four-way controller () to select [Image Tone].

3 Press the four-way controller ().

A pull-down menu appears.

4 Use the four-way controller () to select a finishing tone.

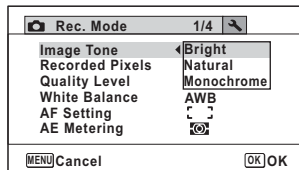



5 Press the **OK** button.

The setting is saved.

6 Press the **MENU** button.

The camera returns to capture mode.



- When [Monochrome] is selected, [Tone Adjustment] appears on the [ Rec. Mode] menu for setting the tone of monochrome images instead of [Saturation].
- Select [Monochrome] in  (Report) mode to fix the Tone Adjustment setting to [Standard].

Selecting the Number of Recorded Pixels

You can choose recorded pixels settings for still pictures.

The larger the number of recorded pixels, the clearer the details will appear when you print your picture. As the quality of the printed picture also depends on the image quality, exposure control, resolution of the printer, and other factors, you do not need to select more than the required number of recorded pixels. **3M** is adequate for making postcard-size prints. The more pixels there are, the larger the picture and the bigger the file size. Refer to the following table for the appropriate settings according to expected usage.

Recorded Pixels	Expected Usage
12M 4000×3000	↑ Clearer For printing high quality photos or A4-size pictures or larger, or editing images on a computer.
9M 16:9 4000×2256	
7M 3072×2304	
5.3M 16:9 3072×1728	
5M 2592×1944	
3.8M 16:9 2592×1464	For making postcard-size prints.
3M 2048×1536	
2.1M 16:9 1920×1080	For posting on a website or attaching to e-mail.
1280 1280×960	
1024 1024×768	
640 640×480	

- The default setting is **12M**.
- **1280** (1280×960) can only be set for recorded pixels when  (Report) mode is set. **1280** does not appear in the Recorded Pixels menu.



If you select **9M 16:9** / **5.3M 16:9** / **3.8M 16:9** / **2.1M 16:9**, the aspect ratio of the screen is 16:9. The monitor display for recording and playback is as shown on the right.

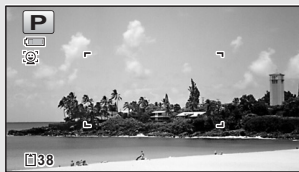

1 Press the MENU button in mode.

The [ Rec. Mode] menu appears.

2 Use the four-way controller () to select [Recorded Pixels].

3 Press the four-way controller () .

A pull-down menu appears.

4 Use the four-way controller () to change the number of recorded pixels.

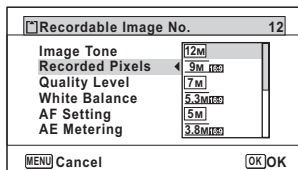







5 Press the OK button.

The setting is saved.

6 Press the MENU button.

The camera returns to capture mode.



- The number of recorded pixels for images captured in  (Green) mode is fixed at **12M**.
- The number of recorded pixels for images captured in  (Frame Composite) is fixed at **3M**/**2.1M**.
- The number of recorded pixels for images captured in **WIDE** (Digital Wide) mode is fixed at **5M**. (The number of recorded pixels will be **3M** if you exit Digital Wide mode without taking the second picture.)
- The number of recorded pixels for images shot in  (Report) mode is set to **1280** (1280×960).
- If you take and save only the first frame in  (Digital Panorama) mode, the number of recorded pixels is fixed at **2M**.
- The number of recorded pixels for images captured in  (Digital SR) mode is fixed at **5M**/**3.8M**.
- The number of recorded pixels for images captured in  (Digital Microscope) mode is fixed at **2.1M**.

Selecting the Quality Level of Still Pictures

Select the quality (data compression ratio) for still images according to how the images will be used.

The more stars (★), the higher the quality of the image, but the file size increases. The selected Recorded Pixels setting also affects the size of the image file (p. 125).

Quality Level

★★★	Best	Lowest compression ratio. Suitable for photo prints.
★★	Better	Standard compression ratio. Suitable for viewing the image on a computer screen. (default setting)
★	Good	Highest compression ratio. Suitable for attaching to e-mails or creating websites.

1 Press the MENU button in mode.

The [ Rec. Mode] menu appears.

2 Use the four-way controller (▲▼) to select [Quality Level].

3 Press the four-way controller (▶).

The pull-down menu appears.

4 Use the four-way controller (▲▼) to change the quality level.

The maximum number of pictures you can take is displayed at the top of the screen when you select a quality level.

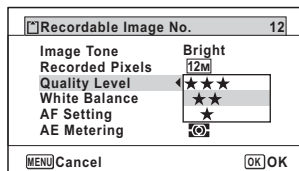

5 Press the OK button.

The setting is saved.

6 Press the MENU button.





The camera is ready for taking pictures.



In  (Green) mode, the quality level is fixed at ★★ (Better).

Adjusting the White Balance

You can take pictures in natural colors by adjusting the white balance according to the light conditions at the time of shooting.

AWB	Auto	The camera adjusts the white balance automatically.
	Daylight	Use this mode when taking pictures outside in sunlight.
	Shade	Use this mode when taking pictures outside in the shade.
	Tungsten Light	Use this mode when taking pictures under electric or other tungsten light.
	Fluores. Light	Use this mode when taking pictures under fluorescent light.
	Manual	Use this mode when adjusting the white balance manually.

3



- Set another white balance if you are not satisfied with the color balance of pictures taken with the white balance set to **AWB**.
- Depending on the selected shooting mode, the white balance setting may not be changed. Refer to "Functions Available for Each Shooting Mode" (p.288) for details.

1 Press the **MENU** button in mode.

The [ Rec. Mode] menu appears.

2 Use the four-way controller () to select [**White Balance**].

3 Press the four-way controller () .

The [White Balance] screen appears.

4 Use the four-way controller () to change the setting.

You can check the results of available white balance settings on the preview image each time you press the four-way controller.

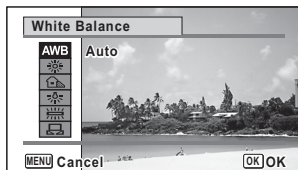

5 Press the **OK** button.

The setting is saved.

6 Press the MENU button.

The camera returns to capture mode.

Refer to the following “Manual Setting” for instructions on adjusting the white balance manually.



If you change the [White Balance] setting frequently, you can save time by assigning the Fn settings to the Green button (p.139).

Saving the White Balance setting p.158

Manual Setting

Have a blank sheet of white paper or similar material ready.

1 In the [White Balance] screen, use the four-way controller (▲▼) to select (Manual).

2 Point the camera at the blank sheet of paper or other material so that it fills the frame displayed in the center of the screen.

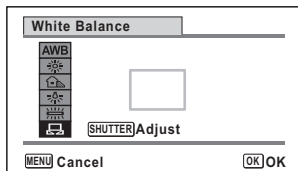

3 Press the shutter release button fully.

The white balance is automatically adjusted.

4 Press the OK button.



The setting is saved and the screen returns to the [📷 Rec. Mode] menu.

5 Press the MENU button.

The camera returns to capture mode.

Setting the AE Metering

You can set the area of the screen where the brightness is metered to determine the exposure.

	Multi-segment metering	The camera divides the image into 256 areas, meters the brightness and determines the exposure.
	Center-weighted metering	The camera takes a reading of the overall brightness of the picture with the center of the image having more influence on the exposure.
	Spot AE metering	The camera determines the exposure by metering the brightness only at the center of the image.

3

1 Press the MENU button in mode.

The [ Rec. Mode] menu appears.

2 Use the four-way controller (▲▼) to select [AE Metering].

3 Press the four-way controller (▶).

A pull-down menu appears.

4 Use the four-way controller (▲▼) to select a metering method.

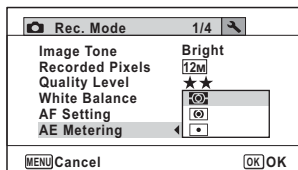

5 Press the OK button.

The setting is saved.

6 Press the MENU button.

The camera returns to capture mode.











- When the shutter release button is pressed halfway, the brightness is metered and the exposure is determined.
- When the subject is outside the focusing area and you want to use Spot AE metering, aim the camera at the subject and press and hold the shutter release button halfway to lock the exposure, then compose your picture again and press the shutter release button fully.
- Depending on the selected shooting mode, the [AE Metering] setting may not be changed. Refer to "Functions Available for Each Shooting Mode" (p.288) for details.

Saving the AE Metering setting  p.158

Setting the Sensitivity

You can select the sensitivity to suit the brightness of the surroundings.

AUTO	The sensitivity is automatically adjusted by the camera. (Default value: sensitivity 80-800)
80	 <p>The lower the sensitivity, the less noise that affects the image. The shutter speed will be slower in low light conditions.</p> <p>Higher sensitivity settings use faster shutter speeds in low light conditions to reduce camera shake, but the image may be affected by noise.</p>
100	
200	
400	
800	
1600	
3200	
6400	

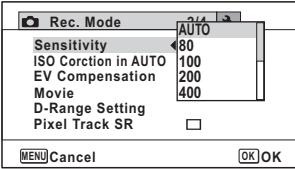
- 1 Press the MENU button in  mode.**
The [ Rec. Mode] menu appears.
 - 2 Use the four-way controller ( ) to select [Sensitivity].**
 - 3 Press the four-way controller ().**
A pull-down menu appears.
 - 4 Use the four-way controller ( ) to change the sensitivity.**
- 
- 5 Press the OK button.**
The setting is saved.
 - 6 Press the MENU button.**
The camera returns to capture mode.



- When the sensitivity is set to 3200 or 6400, the number of recorded pixels is fixed at [5M] (2592×1944)/[3.8M16:9] (2592×1464).
- When set to (Digital SR), (Green), (Movie), or (Underwater Movie) mode, only [AUTO] is available.
- When set to (Fireworks) mode, the sensitivity is fixed at 80.
- When the shooting mode is set to (Report), the AUTO is fixed at 80-6400. Other sensitivities can also be selected.

Saving the Sensitivity setting p.158

3

Setting ISO Correction in AUTO

Set the sensitivity range when the sensitivity is set to AUTO.
The sensitivity can be set to 80-100, 80-200, 80-400, 80-800, and 80-1600.

1 Press the MENU button in mode.

The [Rec. Mode] menu appears.

2 Use the four-way controller (▲▼) to select [ISO Corction in AUTO].

3 Press the four-way controller (▶).

A pull-down menu appears.

4 Use the four-way controller (▲▼) to select the sensitivity adjustment range.

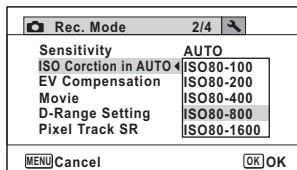

5 Press the OK button.

The setting is saved.

6 Press the MENU button.

The camera returns to capture mode.



When the Sensitivity is set to 80 or 100 and Highlight Correction is set to (On), the setting changes to 160. The setting returns when Highlight Correction is set to (Off).

Setting the Exposure (EV Compensation)

For adjusting the overall brightness of the picture.

Use this function to take pictures that are intentionally overexposed or underexposed.

1 Press the **MENU** button in **📷 mode**.

The [📷 Rec. Mode] menu appears.

2 Use the four-way controller (▲▼) to select [EV Compensation].

3 Use the four-way controller (◀▶) to select the EV value.

To brighten, select a positive (+) value. To darken, select a negative (-) value.

You can choose the EV setting in the range of -2.0 EV to +2.0 EV in 1/3 EV steps.

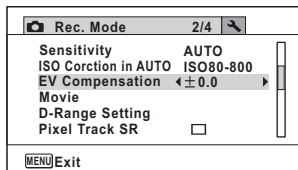

4 Press the **MENU** button.

The camera returns to capture mode.



- When a histogram is displayed in Still Picture Capture mode or Playback mode, you can check whether the exposure is correct (p.34).
- EV Compensation cannot be used in **AUTO PICT** (Auto Picture) or **●** (Green) mode.

Saving the EV Compensation setting p.158

Correcting the Brightness (D-Range Setting)

Expands the dynamic range and prevents bright and dark areas from occurring. [Highlight Correction] adjusts the bright areas when the image is too bright and [Shadow Correction] adjusts the dark areas when the image is too dark.

1 Press the **MENU** button in **📷** mode.

The [📷 Rec. Mode] menu appears.

2 Use the four-way controller (▲▼) to select [D-Range Setting].

3 Press the four-way controller (▶).

The [D-Range Setting] screen appears.

4 Use the four-way controller (▲▼) to select [Highlight Correction] or [Shadow Correction].

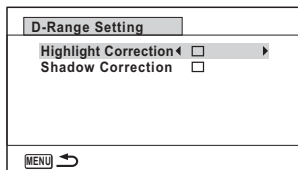

5 Use the four-way controller (◀▶) to select or .

6 Press the **MENU** button twice.

The camera returns to capture status. The D-Range Setting icon appears on the display.



	When [Highlight Correction] is set to <input checked="" type="checkbox"/>
	When [Shadow Correction] is set to <input checked="" type="checkbox"/>
	When [Highlight Correction] and [Shadow Correction] are set to <input checked="" type="checkbox"/>



- When the Sensitivity is set to 80 or 100 and Highlight Correction is set to (On), the setting changes to 160. The setting returns when Highlight Correction is set to (Off).
- If you change the [Highlight Correction] or [Shadow Correction] setting frequently, you can save time by assigning it to the Green button (p.139).



D-Range settings are not applicable in (Auto Picture)/ (Green) modes.

Setting Pixel Track SR

You can set this function to correct for camera shake when taking still shots. If Pixel Track SR is set to (On), the camera automatically corrects for camera shake in the images you shot. The default setting is (Off).



Shake reduction settings in (Movie) and (Underwater Movie) mode are configured under Movie SR (p.153).

3

1 Press the MENU button in mode.

The [Rec. Mode] menu appears.

2 Use the four-way controller () to select [Pixel Track SR].

3 Use the four-way controller () to switch between

(On) or (Off).

- (On) Automatically corrects for camera shake.
- (Off) No correction for camera shake.

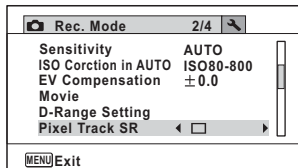

The setting is saved.

4 Press the MENU button.

The camera returns to capture mode.



In (Green), (Digital Wide), (Digital Panorama), (Movie), (Underwater Movie), (Frame Composite), and (Fireworks) mode, the Pixel Track SR is fixed at (Off).



The Pixel Track SR may not be effective when the shutter speed is slow. We recommend you turn off the [Pixel Track SR] setting (off) and use a tripod for slow shutterspeeds.

Setting the Interval Shooting

In this mode, a set number of pictures can be taken automatically at a set interval from a set time.

Interval	10 sec. – 99 min.	Set the camera to take pictures at intervals. The intervals can be set in increments of one second from ten seconds to 4 minutes, or in 1 minute increments from 4 to 99 minutes. You cannot set the camera to take interval shots for less than ten seconds.
Number of Shots	2 shots – number of recordable images	You can set this to up to 1000 shots. However, it cannot exceed the number of recordable images.
Start Delay	0 min. – 24 hours	You can set 1 minute increments for the first 59 minutes and 1 hour increments from there. If the start time is set to 0 minutes, the first picture is taken as soon as the shutter release button is pressed.

1 Press the MENU button in mode.

The [ Rec. Mode] menu appears.

2 Use the four-way controller (▲▼) to select [Interval Shoot].

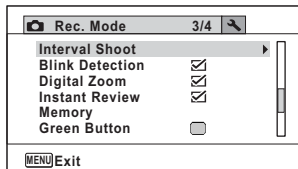

3 Press the four-way controller (▶).

The [Interval Shoot] setting screen appears. [Interval] is marked with the frame.

4 Set the interval.

1 Press the four-way controller (▶).

2 Use the four-way controller (▲▼) to set the minutes, then press the four-way controller (▶).

3 Use the four-way controller (▲▼) to set the seconds, then press the four-way controller (▶).

The setting is saved, and the frame returns to [Interval].

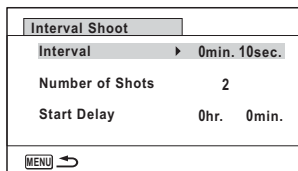

5 Press the four-way controller (▼).

The frame moves to [Number of Shots].

6 Set the number of shots.

1 Press the four-way controller (▶).

2 Use the four-way controller (▲▼) to set [Number of Shots], then press the four-way controller (▶).

The setting is saved, and the frame returns to [Number of Shots].

7 Press the four-way controller (▼).

The frame moves to [Start Delay].

8 Set the start delay.

1 Press the four-way controller (▶).

The current time and the recording start time are displayed in real-time.

2 Use the four-way controller (▲▼) to set the hours, then press the four-way controller (▶).

3 Use the four-way controller (▲▼) to set the minutes, then press the four-way controller (▶).

The setting is saved, and the frame returns to [Start Delay].

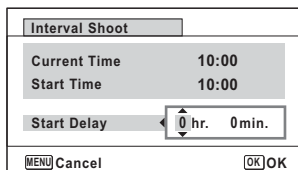

9 Press the MENU button twice.

The camera returns to the shooting screen. The operations up to this point have only configured the [Interval Shoot] settings. To actually use interval shooting, you must select [Interval Shoot] from the drive mode.

Taking Pictures at a Set Interval (Interval Shoot) p.108



- Interval Shoot is unavailable in (Auto Picture), (Green), (Digital Panorama), (Digital Wide), (Fireworks) and (Voice Recording) modes.
- Refer to p.154 for instructions on interval shooting for (Movie) and (Underwater Movie).
- Even if an alarm is set, the alarm will not ring while interval shooting is being performed.
- Interval Shoot stops if the SD Memory Card is removed or inserted during standby.



The Interval Shoot settings can also be configured from the Drive Mode (p.108).

Setting Blink Detection

This specifies whether Blink Detection works when you use the Face Detection function. The default setting is (On).

1 Press the **MENU** button in mode.

The [ Rec. Mode] menu appears.

2 Use the four-way controller () to select [**Blink Detection**].

3 Use the four-way controller () to switch between (On) or (Off).

- (On) Blink Detection function works.
- (Off) Blink Detection function does not work.

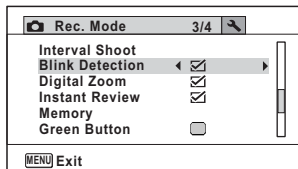

The setting is saved.

4 Press the **MENU** button.

The camera returns to capture mode.

Blink Detection  p.77



If the Blink Detection function detected closed eyes when shooting, [Closed eyes have been detected] is displayed for 3 seconds during Instant Review.

Setting the Instant Review

Use this setting to specify whether or not an Instant Review is displayed immediately after images are shot. The default setting is (On: displays the image).

1 Press the **MENU** button in **📷 mode**.

The [📷 Rec. Mode] menu appears.

2 Use the four-way controller (**▲ ▼**) to select [Instant Review].

3 Use the four-way controller (**◀ ▶**) to switch between (On) or (Off).

- (On) Instant Review is displayed.
- (Off) Instant Review is not displayed.

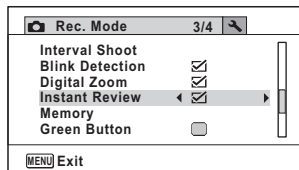

The setting is saved.

4 Press the **MENU** button.

The camera returns to capture mode.

Instant Review p.77

Setting the Green Button

You can assign one of the following functions to the Green button: [Green Mode] (p.86), [Voice Recording] (p.224) or [Fn Setting] (p.141). You can activate the assigned function by just pressing the Green button.



When the shooting mode is set to **🟢** (Green) Mode, [Green Button] settings cannot be configured on the [📷 Rec. Mode] menu. To configure the settings, first switch to a mode other than **🟢**.

Assigning a Function

1 Press the MENU button in mode.

The [ Rec. Mode] menu appears.

2 Press the four-way controller (▲▼) to select [Green Button].

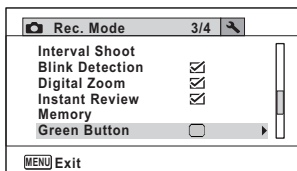

3 Press the four-way controller (▶).

A pull-down menu appears.

4 Use the four-way controller (▲▼) to select a function you want to assign.

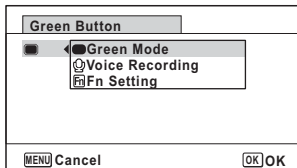

5 Press the OK button.

The setting is saved.

6 Press the MENU button.

The camera returns to capture mode.



[Green Mode] is registered as the default setting.

Registering Frequently Used Functions (Fn Setting)

You can register frequently used functions on the four-way controller. Using this function, you can directly set the functions by pressing the four-way controller without displaying the menu in Capture mode. In [Fn Setting], still picture mode and Movie mode have different settings. To execute [Fn Setting] in movie mode, press the MENU button in Movie mode in step 1 on page p.140.

4 Use the four-way controller (▲▼) to select [Fn Setting].

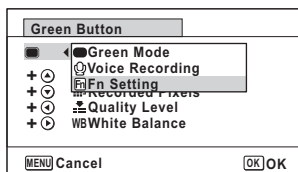

5 Press the OK button.

The [Fn Setting] screen appears.

6 Use the four-way controller (▲▼) to select a key you want to assign a function to.

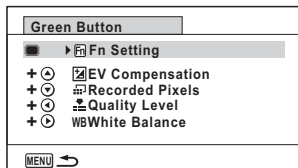

7 Press the four-way controller (▶).

A pull-down menu appears.

8 Use the four-way controller (▲▼) to select the function you want to register.

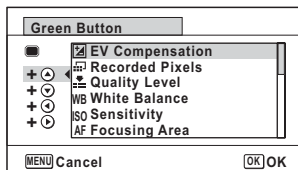

9 Press the OK button.

The setting is saved.

10 Press the MENU button twice.

The camera returns to capture mode.



This function is activated only when you assign the [Fn Setting] to the Green button.



You can assign only one function to each key.

The default settings for Fn settings

	Still picture mode	Movie mode
Default setting	(▲) EV Compensation	(▲) Movie SR
	(▼) Recorded Pixels	(▼) EV Compensation
	(◀) Quality Level	(◀) Recorded Pixels
	(▶) White Balance	(▶) White Balance

Functions that can be assigned to each key

	Still picture mode	Movie mode
Selectable items	EV Compensation	Recorded Pixels
	Recorded Pixels	Movie SR
	Quality Level	White Balance
	White Balance	Focusing Area
	Sensitivity	EV Compensation
	Focusing Area	Sharpness
	Auto Macro	Saturation (Tone Adjustment) *
	AE Metering	Contrast
	Highlight Correction	
	Shadow Correction	
	Sharpness	
	Saturation (Tone Adjustment) *	
	Contrast	

* The items displayed change depending on the [Image Tone] selected on the [Rec. Mode] menu. When you have selected either [Bright] or [Natural], [Saturation] is displayed, and when [Monochrome] is selected, [Tone Adjustment] is displayed.

Changing Assigned Items

Press the Green button in the shooting mode to display the Fn Setting screen. Select an item with the four-way controller (▲▼◀▶), and press either the (▲▼) or (◀▶) four-way controller to change the settings.

Setting the Image Sharpness (Sharpness)



You can give the image sharp or soft outlines.

1 Press the MENU button in mode.

The [ Rec. Mode] menu appears.

2 Use the four-way controller (▲▼) to select [Sharpness].

3 Use the four-way controller (◀▶) to change the sharpness level.

-  Soft
-  Normal
-  Sharp

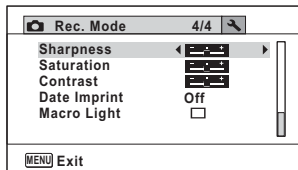

4 Press the MENU button.

The setting is saved and the camera returns to capture mode.

Setting the Saturation/Tone Adjustment

You can set either color brightness (Saturation) or the tone of monochrome images (Tone Adjustment).

The items displayed change depending on the [Image Tone] selected on the [ Rec. Mode] menu.

Selected Image Tone	Displayed item
Bright, Natural	Saturation
Monochrome	Tone Adjustment



3

1 Press the MENU button in mode.

The [ Rec. Mode] menu appears.

2 Use the four-way controller (▲▼) to select [Saturation] (Tone Adjustment).

3 Use the four-way controller (◀▶) to select the level of saturation (or tone).

-  Low (Blue for tone)
-  Normal (B&W for tone)
-  High (Sepia for tone)

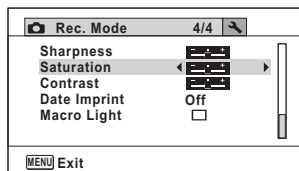









4 Press the MENU button.

The setting is saved and the camera returns to capture mode.

Setting the Image Contrast (Contrast)





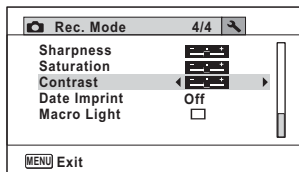

For setting the image contrast level.

- 1 Press the MENU button in  mode.**
The [ Rec. Mode] menu appears.
- 2 Use the four-way controller ( ) to select [Contrast].**
- 3 Use the four-way controller ( ) to change the contrast level.**
 Low
 Normal
 High
- 4 Press the MENU button.**
The setting is saved and the camera returns to capture mode.



Setting the Date Imprint Function

You can choose whether to imprint the date and/or time when taking still pictures.

- 1 Press the MENU button in  mode.**
The [ Rec. Mode] menu appears.
- 2 Use the four-way controller ( ) to select [Date Imprint].**
- 3 Press the four-way controller ().**
A pull-down menu appears.
- 4 Use the four-way controller ( ) to select the Date Imprint details.**
Choose from [Date], [Date & Time], [Time] or [Off].

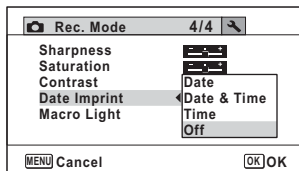

5 Press the OK button.

The setting is saved.

6 Press the MENU button.

The camera returns to capture mode.



- The date and/or time imprinted with the [Date Imprint] function cannot be deleted.
- Note that if the printer or the image editing software is set to print the date and the images to be printed already have the date and/or time imprinted, the imprinted dates and/or times may overlap.



- **DATE** appears on the display in mode when [Date Imprint] is set to any setting other than [Off].
- The date and/or time are imprinted on the picture with the display format set in the [Date Adjustment] screen (p.55).

Setting the Macro Light

Set whether or not to turn on the 3 macro lights around the lens.
The macro lights turn on when the [Macro Light] is set to .
The default setting is .

1 Press the MENU button in mode.

The [Rec. Mode] menu appears.

2 Use the four-way controller (▲▼) to select the [Macro Light].**3 Use the four-way controller (◀▶) to select [(On)/ (Off)].**

- (On) Turns on the light
- (Off) Turns off the light

The setting is saved.

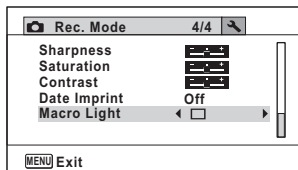
**4 Press the MENU button.**

The camera returns to capture mode.



- In  (Digital Microscope) mode, light turns on regardless of whether the setting is turned on or off.
- If the Power Saving is set to on, the light turns off after the set time.
- The macro lights turn off during playback and when using the USB connector except when outputting video in Digital Microscope mode.



If the Self Timer and Remote Control are set in the drive mode, then the Self Timer lamp and the 3 LEDs for macro photography are:

Macro Light is (Off): The macro light and the Self Timer lamp blink when counting down.

Macro Light is (On): The macro light stays on when counting down.

Taking Pictures Underwater

Taking Underwater Pictures (Underwater Mode/ Underwater Movie Mode)

This camera complies with JIS waterproof grade 8 and can be used to take pictures at a depth of 6 m continuously for 2 hours. In addition, this camera complies with JIS dustproof grade 6 (IP68).







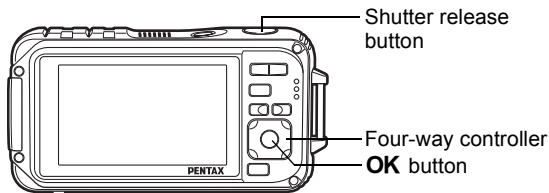

Use the Underwater mode to take underwater still pictures that capture the blueness of the sea.



Use the Underwater Movie mode to record movies underwater.



- 1 Press the four-way controller (▼) in  mode.**
The Capture Mode Palette appears.
- 2 Use the four-way controller (▲▼◀▶) to select  (Underwater) or  (Underwater Movie).**
- 3 Press the OK button.**
The shooting mode is selected and the camera returns to capture mode.
- 4 Press the shutter release button halfway.**
The focus frame on the display turns green when the camera focuses on the subject at the correct distance.
- 5 Press the shutter release button fully.**
If you selected , the picture is taken.
If you selected , recording starts. To stop recording, press the shutter release button fully. Perform the same steps as  (Movie) mode to record movies.

Recording Movies  p.150



- Before taking pictures underwater, make sure that there is no dirt or sand on the waterproof seal of the battery/card and terminal covers and check that the covers are securely locked.
- Before opening the battery/card and terminal covers after using the camera underwater, make sure that there is no water, dirt, or sand on the covers or anywhere else on the camera. Wipe the camera before opening the covers.
- In mode, AE metering is set to multi-segment metering.

Regarding Waterproof, Dustproof, and Shockproof Design p.8



- The flash will not discharge in mode.
- When the Focus Mode is set to **AF**, , or , pictures are taken by pressing the shutter release button half-way down to lock the focus before shooting.
- When the Focus Mode is set to **MF**, you can adjust the focus before recording starts and during recording.
- Optical and digital zoom can be used in Underwater Movie mode before recording starts. Digital Zoom can also be used during recording.

Although the camera is designed to be waterproof and dustproof, avoid using the camera under the following conditions. It may momentarily be subjected to water pressure beyond that covered in the guarantee and water may enter the interior of the camera.

- Jumping into the water while holding the camera
- Swimming while holding the camera in your hand
- Using the camera in environments where water is applied forcefully, such as strong river currents and waterfalls

Recording Movies

Recording Movies

This mode enables you to record movies. Sound is recorded at the same time.

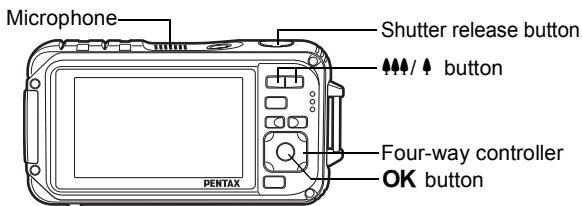

- 1 Press the four-way controller (▼) in mode.

The Capture Mode Palette appears.

- 2 Use the four-way controller (▲▼◀▶) to select (Movie).



- 3 Press the OK button.

(Movie) mode is selected and the camera returns to capture mode. The following information appears on the display.

- 1 Movie mode icon
- 2 Movie shake reduction icon
- 3 Remaining recordable time
- 4 REC indicator (blinks during recording)
- 5 Focus frame (does not appear during recording)

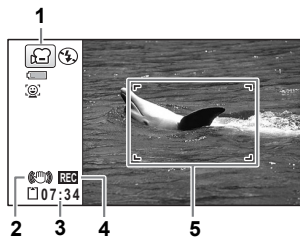

You can change the captured area by pressing the button.

Enlarges the subject

Widens the area that is captured by the camera

4 Press the shutter release button fully.

Recording starts. You can continue recording until the built-in memory or the SD Memory Card is full, or the size of the recorded movie reaches 2 GB.

5 Press the shutter release button fully.

Recording stops.

Playing Back a Movie p.163



- The flash does not discharge in (Movie) mode.
- The focus mode can be changed before recording starts.
- When the focus mode is set to **MF** (Manual Focus), you can adjust the focus before recording starts.
- Optical and digital zoom can be used before recording starts. Digital zoom is available during recording when digital zoom (p.89) is set to (On).
- When the shooting mode is set to (Movie), Face Detection is automatically set to on. You can select Smile Capture or Face Detection Off by pressing the button before starting recording a movie (p.81). When Smile Capture function is activated, movie recording starts automatically when the camera recognizes the subject's smile. However, depending on the condition of the recognized faces, movie recording may not start automatically because the Smile Capture function may not work. If this happens, press the shutter release button to start movie recording.
- The volume of recorded audio may vary depending on the orientation of the microphone, which is on the top of the camera.
- You can record a movie using the remote control unit (optional) (p.106).
- When you change the display by pressing the **OK/DISPLAY** button while recording a movie, the registered subscreen is not displayed.







Keeping the Shutter Release Button Pressed

If you keep the shutter release button pressed for more than one second, recording will continue as long as you keep the button pressed. Shooting stops when you take your finger off the shutter release button.









Selecting the Number of Recorded Pixels and Frame Rate for Movies

You can choose the number of recorded pixels and frame rate settings for movies.

The more pixels there are, the clearer the details and the bigger the file size. The more frames per second, the better the quality of the movie, but the file size becomes larger.

Setting	Recorded Pixels	Frame Rate	Use
	1280×720	30 fps	Records images in HDTV format (16:9). Movement is recorded smoothly. (default setting)
	1280×720	15 fps	Records images in HDTV format (16:9). Increases the total recording time by making the file size smaller.
	640×480	30 fps	Suitable for viewing on a TV or computer screen. Movement is recorded smoothly.
	640×480	15 fps	Suitable for viewing on a TV or computer screen. Increases the total recording time by making the file size smaller.
	320×240	30 fps	Suitable for posting on a website or attaching to e-mail. Movement is recorded smoothly.
	320×240	15 fps	Suitable for posting on a website or attaching to e-mail. Increases the total recording time by making the file size smaller.

* The frame rate (fps) indicates the number of frames per second.

- 1 Press the MENU button in  mode.**
The [ Rec. Mode] menu appears.
- 2 Use the four-way controller ( ) to select [Movie].**
- 3 Press the four-way controller ().**
The [Movie] screen appears.
- 4 Use the four-way controller ( ) to select [Recorded Pixels].**
- 5 Press the four-way controller ().**
A pull-down menu appears.

- 6** Use the four-way controller (▲▼) to change the number of recorded pixels and frame rate.

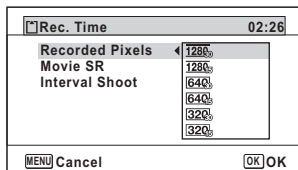

- 7** Press the OK button.

The setting is saved.

- 8** Press the MENU button twice.

The camera returns to capture mode.



The following restrictions may cause the selected recording time and the actual recording time to be different.

- The maximum size of a file is limited to 2 GB.

Setting the Movie SR (Movie Shake Reduction) Function

In  (Movie) mode, you can compensate for camera shake while you are recording a movie with the Movie SR (Movie Shake Reduction) function.

- 1** Press the MENU button in  mode.

The [Rec. Mode] menu appears.

- 2** Use the four-way controller (▲▼) to select [Movie].

- 3** Press the four-way controller (▶).

The [Movie] screen appears.

- 4** Use the four-way controller (▲▼) to select [Movie SR].

5 Use the four-way controller (◀▶) to select (On) or (Off).

- (On) Automatically corrects for camera shake.
- (Off) No correction for camera shake.

The setting is saved.

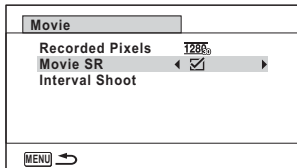

6 Press the MENU button twice.

The camera returns to capture mode.

Recording a Movie from Pictures Taken at a Set Interval (Interval Movie)

In this mode, you can record multiple still pictures taken automatically at a set interval from a set time, as a movie file.

Interval	You can set this to 1 minute, 5 minutes, 10 minutes, 30 minutes, or 1 hour.
Total Time	Set the total time, from 10 minutes to 359 hours. The total time and the settable units change depending on the interval set. The Interval can be set in increments of 1 minute, 5 minutes, 10 minutes, 30 minutes, or 1 hour.
Start Delay	Set the start delay, from 0 minutes to 24 hours. The start delay can be set in increments of 1 minute for a delay time up to 59 minutes, and increments of 1 hour for a delay time longer than one hour. If the start time is set to 0 minutes, the first picture is taken as soon as the shutter release button is pressed.

Setting from Drive Mode

1 Press the four-way controller (▲) in or mode.

2 Use the four-way controller (◀▶) to select (Interval Shoot) and press the OK button.

The current Interval Movie setting appears for approximately one minute. To take pictures with the current settings, go to step 10.

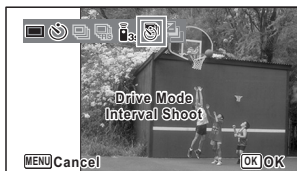

- 3 Press the OK button while the settings are displayed.**
The Interval Movie setting screen appears. [Interval] is marked with the frame.

4 Set the interval.

- 1 Press the four-way controller (▶).
A pull-down menu appears.
- 2 Use the four-way controller (▲▼) to set the interval, then press the OK button.

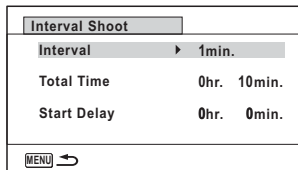

The frame returns to [Interval].

5 Press the four-way controller (▼).

The frame moves to [Total Time].

6 Set the total time.

- 1 Press the four-way controller (▶).
- 2 Use the four-way controller (▲▼) to set the hours, then press the four-way controller (▶).
- 3 Use the four-way controller (▲▼) to set the minutes, then press the four-way controller (▶).

The frame returns to [Total Time].

7 Press the four-way controller (▼).

The frame moves to [Start Delay].

8 Set the start delay.

- 1 Press the four-way controller (▶).
- 2 Use the four-way controller (▲▼) to set the hours, then press the four-way controller (▶).
- 3 Use the four-way controller (▲▼) to set the minutes, then press the four-way controller (▶).

The frame returns to [Start Delay].

9 Press the MENU button.

The Interval movie setting is saved and the camera returns to capture mode.

10 Press the shutter release button halfway.

The focus frame on the display turns green if the subject is in focus.

11 Press the shutter release button fully.

Interval movie recording starts.

The LCD turns off between shots (during standby). Press the power switch during standby to display the remaining time and interval on the monitor.

The [Stop interval shooting?] message is displayed when the power switch and then the **MENU** button are pressed during standby.

Pressing the **OK** button cancels interval movie.

Setting from Menu

You can set the Interval Movie from [📷 Rec. Mode] menu.

1 Press the MENU button in 📷 mode.

The [📷 Rec. Mode] menu appears.

2 Use the four-way controller (▲▼) to select the [Movie].**3 Press the four-way controller (▶).**

The [Movie] screen appears.

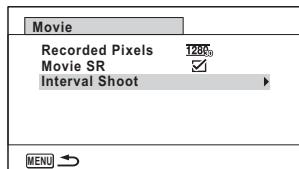
4 Use the four-way controller (▲▼) to select the [Interval Shoot].**5 Press the four-way controller (▶).**

The interval movie setting screen appears. The rest of the procedure is the same as steps 4-11 in "Setting from Drive Mode". See those procedures if you need more information.



- Confirm that the battery is sufficiently charged before starting interval movie recording. If the battery is not sufficiently charged, it may become depleted during interval movie recording and cause recording of the movie to stop.
- When performing interval movie shooting, the settings are fixed as follows; Recorded Pixels: [640], Quality Level: ★★★, Movie SR: (Off), and Flash Mode: . However, shooting is done at a frame rate according to the recorded pixels (p.152) set on the Movie menu.
- Interval Shoot stops if the SD Memory Card is removed or inserted during standby.
- Sound cannot be recorded in Interval Movie mode.



- If you set a start delay, a start time corresponding to the current time and the start delay you set is displayed in real time.
- The total time you can set differs according to the shooting interval you set, as indicated in the table below.







Interval	Total time that can be set	
	30 fps	15 fps
1 min	10 minutes to 5 hours and 59 minutes (in increments of 1 minute)	10 minutes to 5 hours and 59 minutes (in increments of 1 minute)
5 min	30 minutes to 29 hours and 55 minutes (in increments of 5 minutes)	15 minutes to 29 hours and 55 minutes (in increments of 5 minutes)
10 min	1 hour to 59 hours and 50 minutes (in increments of 10 minutes)	30 minutes to 59 hours and 50 minutes (in increments of 10 minutes)
30 min	3 hours to 179 hours and 30 minutes (in increments of 30 minutes)	1 hour and 30 minutes to 179 hours and 30 minutes (in increments of 30 minutes)
1 hr	6 hours to 359 hours (in increments of 1 hour)	3 hours to 359 hours (in increments of 1 hour)

Saving the Settings (Memory)

The Memory function is for saving the current camera settings when the camera is turned off.

For some camera settings, the Memory function is always set to (On) (the settings are saved when the camera is turned off), while for others you can choose on or off (to choose whether the settings are saved or not when the camera is turned off). The items which can be set to On or Off in the Memory function are shown in the table below. (Items not listed here are always saved in the selected settings when the camera is turned off.)

If you select (On), the settings will be saved in the status they were in immediately before the camera was turned off. If you select (Off), the settings will be reset to the defaults when the camera is turned off. The table below also shows whether the Memory default setting for each item is on or off.



Item	Description	Default setting	Page
Face Detection	A Face Detection mode set by using the  button.	<input type="checkbox"/>	p.81
Flash Mode	The flash mode set with the four-way controller (◀)	<input checked="" type="checkbox"/>	p.117
Drive Mode	The drive mode set with the four-way controller (▲)	<input type="checkbox"/>	p.103- p.110
Focus Mode	The focus mode set with the four-way controller (▶)	<input type="checkbox"/>	p.119
Zoom Position	The zoom position set with the  button.	<input type="checkbox"/>	p.87
MF Position	The manual focus position set with the four-way controller (▲▼)	<input type="checkbox"/>	p.120
White Balance	The [White Balance] setting on the [ Rec. Mode] menu	<input type="checkbox"/>	p.128
Sensitivity	The [Sensitivity] setting on the [ Rec. Mode] menu	<input type="checkbox"/>	p.131
EV Compensation	The [EV Compensation] setting on the [ Rec. Mode] menu	<input type="checkbox"/>	p.133
AE Metering	The [AE Metering] setting on the [ Rec. Mode] menu	<input type="checkbox"/>	p.130
Digital Zoom	The [Digital Zoom] setting on the [ Rec. Mode] menu	<input checked="" type="checkbox"/>	p.89
DISPLAY	The display information display mode set with the OK/DISPLAY button	<input type="checkbox"/>	p.24
File No.	If a new SD Memory Card is inserted when On has been selected, file numbers are assigned sequentially.	<input checked="" type="checkbox"/>	—



1 Press the **MENU** button in  mode.

The [ Rec. Mode] menu appears.

2 Use the four-way controller ( ) to select [Memory].

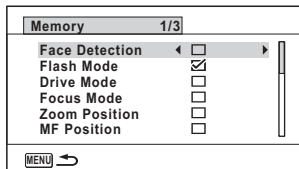
3 Press the four-way controller ().
The [Memory] screen appears.

4 Use the four-way controller ( ) to choose an item.

5 Use the four-way controller ( ) to select (On) or (Off).

6 Press the **MENU** button twice.

The camera returns to capture mode.

Memo

4 **Playing Back and Deleting Images**

Playing Back Images	162
Deleting Images and Sound Files	176
Connecting the Camera to AV Equipment	184

Playing Back Images

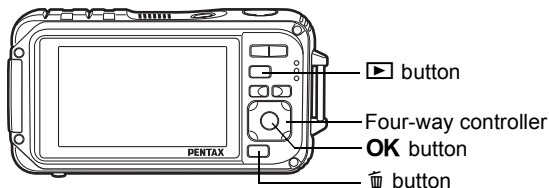

Playing Back Still Pictures



4

Playing Back and Deleting Images

1 Press the button after taking a picture.

The camera enters the  mode and the image appears on the display. Displaying one image in full in  mode ( mode default setting) is called single-image display.

File number





To Play Back the Previous or Next Image

2 Press the four-way controller ().

The previous or next image appears.

To Delete the Displayed Image

Press the  button while the image is displayed to display the Delete screen. Press the four-way controller () to select [Delete] and press the **OK** button.

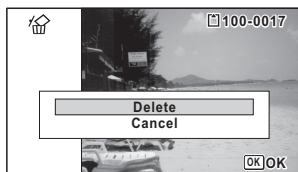



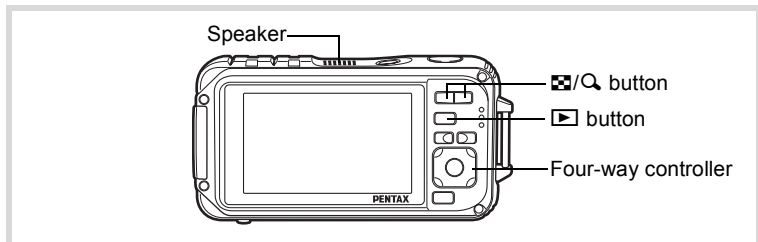

For information on other deletion procedures  p.176

Playing Back a Movie

You can play back the movies you have taken. The sound is played back at the same time.







1 Enter  mode and use the four-way controller ( ) to choose the movie you want to play back.

2 Press the four-way controller () .

Playback starts.



The following operations can be performed during playback.

- | | |
|---|------------------------|
| Four-way controller () | Plays back in reverse |
| Four-way controller () | Pauses playback |
| Zoom button (Q) | Increases the volume |
| Zoom button (Q) | Reduces the volume |
| Press and hold the four-way controller () | Fast-forwards playback |
| Press and hold the four-way controller () | Fast-reverses playback |

The following operations can be performed while playback is paused.

- | | |
|---|--------------------|
| Four-way controller () | Reverses the frame |
| Four-way controller () | Forwards the frame |
| Four-way controller () | Resumes playback |

3 Press the four-way controller () .

Playback stops.

Multi-Image Display

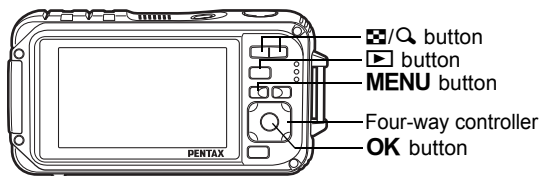

6-Image Display/12-Image Display

4 You can display 6 or 12 thumbnails of captured images at a time.

1 Press the button in mode.

The 6-image display appears showing a page consisting of 6 thumbnail images. Pressing the button again changes it to a 12-image display.

A page consisting of 6 or 12 thumbnail images appears. The displayed images change 6- or 12-images at a time page by page.

Use the four-way controller () to move the frame. If there are too many images to fit on one page, pressing the four-way controller () while image ① is selected will display the previous page. Similarly, if you choose image ② and press the four-way controller () the next page appears.

◆ indicates that the previous or next screen is stored in a separate folder.

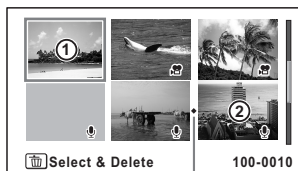

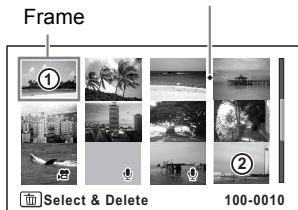

6-Image Display

Folder divider icon



12-Image Display

The icons that appear on the images indicate the following:

(No icon)	Still picture without sound
 (With image)	Still picture with sound
	Movie (the first frame appears)
 (Without image)	Sound files only

Press the **OK** button to switch to single-image display of the selected image.

Press the  button to switch to  mode.

Folder Display/Calendar Display

Press the  button in 12-image display to switch to folder or calendar display. Press the Green button to switch between folder display and calendar display.

1 Press the button twice in mode.





The screen changes to 12-image display.

2 Press the button.

The screen changes to folder display or calendar display.

Folder display

The list of folders with recorded images and sound files appears.

Use the four-way controller (   ) to move the frame.

If you select a folder and press the  button or the **OK** button, images in the folder are displayed in 12-image display.

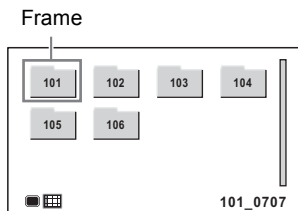

Calendar display

Recorded images and sound files are displayed by date in calendar format. The first image recorded on a date is displayed for that date on the calendar.



 appears for dates on which the first recorded file was either sound-only data or a still picture with a voice memo.

Use the four-way controller () to move the frame.

If you select a date and press the  button, images taken on that date are displayed in 12-image display.

Select a date and press the **OK** button to switch to single-image display of the first image recorded on that date.



- Press the **MENU** button in folder display or calendar display to switch to 12-image display.
- Press the  button or half-press the shutter release button in folder display or calendar display to switch to  mode.

Using the Playback Function

1 In mode, press the four-way controller ().

The Playback Mode Palette appears.

2 Use the four-way controller () to choose an icon.

The guide for the selected function appears below.

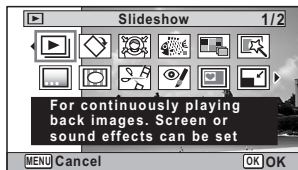

3 Press the **OK** button.

The playback function is recalled.

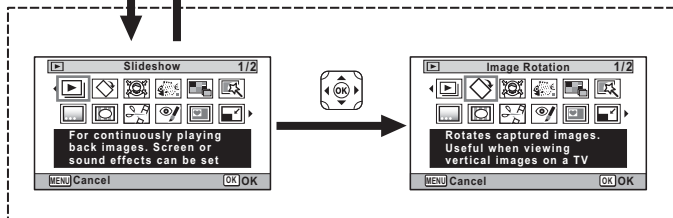
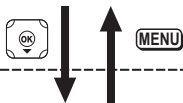

Closes the Playback Mode Palette and goes to mode.

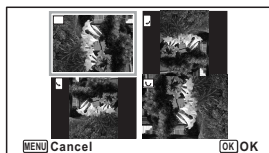



















Goes to the screen for selected playback function.





- When the frame is placed over an icon on the Playback Mode Palette, a guide for that function appears.
- You can turn the guide display off for the function on the Playback Mode Palette (p.254).

Playback Mode Palette

Playback Mode		Description	Page
	Slideshow	For continuously playing back images. Screen or sound effects can be set	p.169
	Image Rotation	Rotates captured images. Useful when viewing vertical images on a TV	p.172
	Small Face Filter	Processing image to reduce the size of a detected face	p.192
	Ink Rubbing Filter	Creates an image similar to ink rubbing from original pictures	p.199
	Collage	Creates a collage print page from saved image files	p.200
	Digital Filter	For modifying images with a Color filter or Soft filter	p.194
	Original Frame	For making a frame by selecting your favorite frame type and color. Text can be entered, too	p.209
	Frame Composite	For composing an image with a frame. Select Overwrite or Save as to save	p.206
	Save as Still image	For saving one frame from a movie as a still picture	p.214
	Divide Movies	For dividing a movie into two	
	Adding title picture	For adding a title picture to your movie	
	Red-eye Compensation	For compensating red-eye. May not work due to the condition of the image	p.205
	Subscreen Input	For displaying the selected image on the subscreen	p.256
	Resize	Changes Recorded Pixels and Quality Level to make the file size smaller	p.190
	Cropping	For cropping images to the size you like. Saved as a new image	p.191
	Image/Sound Copy	For copying images and sounds between the builtin memory and SD memory card	p.217
	Voice Memo	Attaches sound to images. Recording is possible till the memory card is full	p.228
	Protect	Protects images and sounds from accidental deletion. Formatting will delete	p.181
	DPOF	For the print settings. Useful when printing at a printing service	p.219
	Image Recovery	For recovering image and sound files which were accidentally deleted	p.180
	Start-up Screen	For setting a captured image as the Start-up Screen	p.257





Slideshow

You can play back recorded images and movies one after another.

1 Enter the  mode and use the four-way controller ( ) to choose the image to start the slideshow with.

2 Press the four-way controller () .

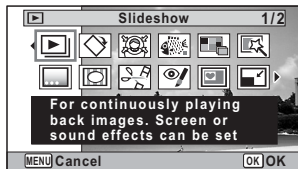

The Playback Mode Palette appears.

3 Use the four-way controller (   ) to select  (Slideshow).



4 Press the **OK** button.

The slideshow setting screen appears.

5 Use the four-way controller ( ) to select [Start].

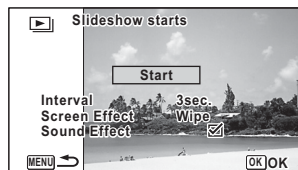

6 Press the **OK** button.

The slideshow starts.

Pressing the **OK** button during the slideshow pauses the slideshow.

To resume the slideshow, press the **OK** button again.

7 Press any button other than the **OK** button.

The slideshow stops.

To Set the Slideshow Conditions

You can set the playback interval and also a screen effect and sound effect for when one image changes to the next.

- 1 Use the four-way controller (▲▼) to select [Interval] in step 5 on p.169.**

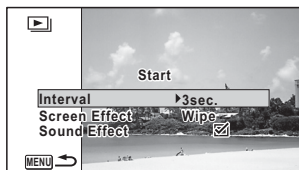

- 2 Press the four-way controller (▶).**

A pull-down menu appears.

- 3 Use the four-way controller (▲▼) to change the interval and press the OK button.**

Choose from [3sec.], [5sec.], [10sec.], [20sec.] or [30sec.].

- 4 Use the four-way controller (▲▼) to select [Screen Effect].**

After selecting [Screen Effect], press the four-way controller (▶). A pull-down menu appears with the following items. Use the four-way controller (▲▼) to select an item and press the **OK** button.

Wipe	The next image slides over the previous one from left to right
Checker	The next image appears in small square mosaic blocks
Fade	The current image gradually fades out and the next image fades in
Off	No effect

- 5 Use the four-way controller (▲▼) to select [Sound Effect].**

- 6 Use the four-way controller (◀▶) to select (On) or (Off).**

Except when the [Screen Effect] is set to Off, you can choose (On) or (Off) for the sound that is played when one image changes to the next.

7 Use the four-way controller (▲▼) to select [Start].

8 Press the OK button.

The slideshow starts using the selected interval and effect.



- The slideshow will continue until you press any button other than the **OK** button.
- Movies or pictures with sound will be played through to the end before the next picture is played back, regardless of the interval setting. However, pressing the four-way controller (▶) while playing back a movie or a picture with sound skips to the next image.
- Sound files made in 🗣️ (Voice Recording) are not played back in the slideshow.
- Panorama images are displayed by scrolling from left to right in 4 seconds before the next picture is played back, regardless of the Interval or Screen Effect setting.

Connecting the Camera to AV Equipment 📖 p.184

Rotating the Image

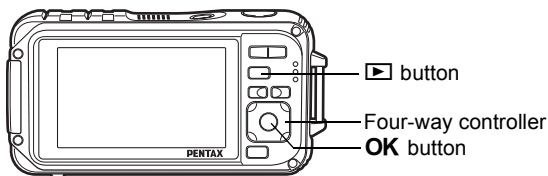

- 1 Press the ▶ button after taking a picture.**
The image appears on the display.
- 2 Press the four-way controller (▼).**
The Playback Mode Palette appears.
- 3 Use the four-way controller (▲▼◀▶) to select ◊ (Image Rotation) and press the OK button.**
The rotation selection screen (0°, Right 90°, Left 90°, or 180°) appears.
- 4 Use the four-way controller (▲▼◀▶) to choose the rotation direction and press the OK button.**
The rotated image is saved.

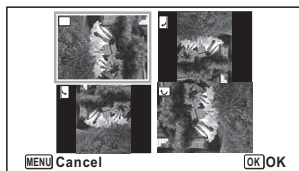

- Panoramic images and movies cannot be rotated.
- Protected images can be rotated, but they cannot be saved in a rotated state.

Zoom Playback

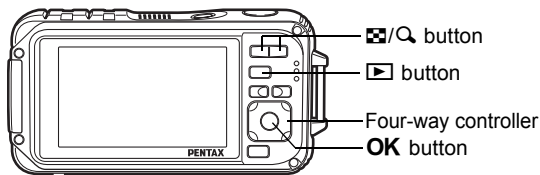

You can magnify an image up to ten times.



1 Enter the  mode and use the four-way controller ( ) to choose the image you want to magnify.

2 Press the  button.

The image is magnified ($\times 1.1$ to $\times 10$). Holding down the  button continuously magnifies the image.







With Quick Zoom (p.253) set to  (On), pressing  once magnifies the image to $10\times$.

You can use the + mark of the guide at the bottom left of the screen to check which portion of the image is magnified.

The following operations can be performed while an image is magnified.



Guide

Four-way controller (   )	Moves the position to be magnified
Zoom button right ()	Makes the image bigger (max. of $10\times$)
Zoom button left ()	Makes the image smaller (min. of $1.1\times$)

3 Press the **OK** button.

The image returns to single-image display.





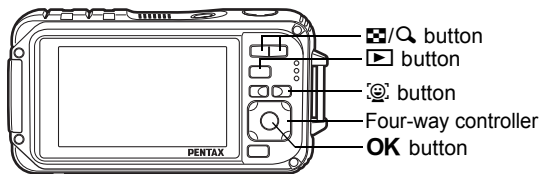

Movies cannot be magnified.

Zoom In on the Subject's Face Automatically (Face Close-up Playback)

You can enjoy playing back images with the subject's faces zoomed up simply by pressing the  button (Face close-up playback) if the Face Detection function operated when the images were taken.



4

- 1 Enter the  mode and use the four-way controller ( ) to choose the image you want to magnify.**
- 2 Confirm that the  icon is displayed in the image and press the  button.**

The image is magnified around the face first recognized when the image was taken.

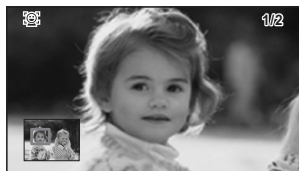

If multiple faces were recognized when the image was taken, the subject's faces are zoomed up on each time the  button is pressed in order of the recognition during shooting.



The following operations can be performed during Face close-up playback mode.

Zoom button right (Q)	Zooms up on the subject being displayed for Face close-up playback at an equal or slightly larger magnification ratio.
Zoom button left (Z)	Zooms up on the subject being displayed for Face close-up playback at an equal or slightly smaller magnification ratio.

3

Press the OK button.

The image returns to single-image display.



- Face close-up playback is not available for images that are saved as still pictures from the movies.
- The magnification ratio for Face close-up playback may differ depending on the conditions such as the size of the face recognized when shooting.
- Face close-up playback is also available for pet's faces recorded in (Pet) mode.

Deleting Images and Sound Files

Delete images and sound files that you do not want to keep.

When images or sound files are inadvertently deleted

The Optio W90 is equipped with a function to recover images and sounds deleted on the camera (p.180).

Deleted images and sound files can be recovered even if the camera has been turned off after deletion as long as the SD Memory Card has not been removed. However, deleted images and sound files cannot be recovered after operations to write data such as taking pictures, recording movies, protecting images, saving DPOF settings, resizing images, cropping images, or formatting has been performed.

4

Playing Back and Deleting Images

Deleting a Single Image/Sound File

You can delete a single image or sound file.



Protected images and sound files cannot be deleted (p.181).

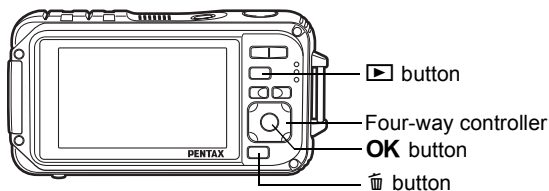

1 Enter the ▶ mode and use the four-way controller (◀▶) to choose the image/sound file you want to delete.

2 Press the 🗑 button.
A confirmation screen appears.

- 3** Use the four-way controller (▲) to select [Delete].

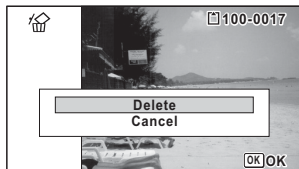

- 4** Press the OK button.

The image is deleted.

Recovering Deleted Images p.180

To Delete a Sound File

If sound (voice memo) has been recorded with an image (p.228), you can delete the sound without deleting the image.

- 1** Enter the  mode and use the four-way controller (◀▶) to choose the image with sound.

 appears on the images with sound.

- 2** Press the  button.

A confirmation screen appears.

- 3** Use the four-way controller (▲) to select [Delete Sound].

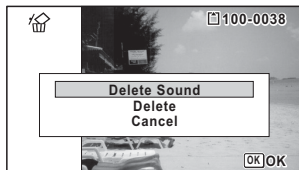

- 4** Press the OK button.

The sound file is deleted.



- Select [Delete] in step 3 to delete both the image and sound file.
- You cannot delete only the sound in a movie.

Deleting Selected Images and Sound Files

You can delete several images/sound files selected from the 6- or 12-image display at once.



Protected images and sound files cannot be deleted (p.181).

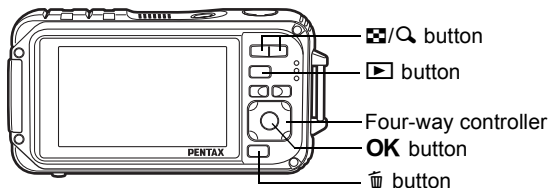

4

1 Press the ☒ button once or twice in ▶ mode.
6-image display or 12-image display appears.

2 Press the 🗑 button.
 appears on the images and sound files.

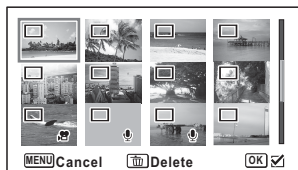

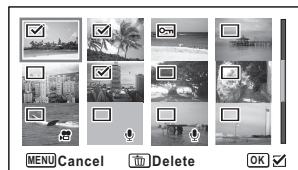

3 Use the four-way controller (▲▼◀▶) to choose the images and sound files that you want to delete and press the OK button.

appears on the selected images and sound files.



Pressing and holding the Q button displays the selected image in a single screen and you can check whether to delete the image. Releasing the button returns to 6- or 12-image display. However, protected images cannot be displayed in single-image display.

- 4** Press the  button.
A confirmation screen appears.

- 5** Use the four-way controller () to select [Select & Delete].

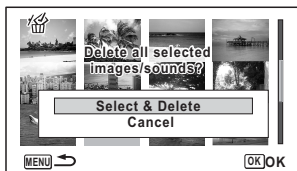

- 6** Press the **OK** button.
The selected images and sound files are deleted.





Deleting All Images and Sound Files

Deletes all the images and sound files at once.

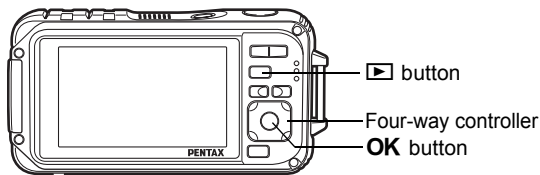

Protected images and sound files cannot be deleted (p.181).



- 1** Press the **MENU** button in  mode.
The [ Setting] menu appears.
When you press the **MENU** button in  mode, press the four-way controller () once.

- 2** Use the four-way controller (▲▼) to select [Delete All].

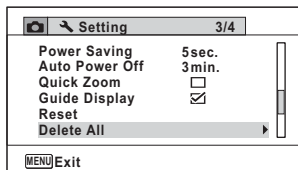

- 3** Press the four-way controller (▶).

A confirmation dialog appears.

- 4** Use the four-way controller (▲) to select [Delete All].

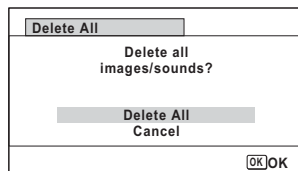

- 5** Press the OK button.

All the images and sound files are deleted.

Recovering Deleted Images

You can recover images or sound files that were taken with this camera and then deleted.



If any of the following operations have been performed after deleting an image, the deleted image and sound file cannot be recovered.

- Shooting
- Protect setting/DPOF setting/Resizing/Cropping
- Registering a subscreen image
- Formatting
- Removing the SD Memory Card

- 1** After deleting a file, press the four-way controller (▼).

The Playback Mode Palette appears.

2 Use the four-way controller (▲▼◀▶) to select (Image Recovery).

When  is displayed, there are no images that can be recovered.



3 Press the OK button.

The number of recoverable images appears.

If you selected  and pressed the **OK** button, the message [No image to be processed] appears. In this case, press the **OK** button to return to the Playback Mode Palette.

4 Use the four-way controller (▲) to select [Recover].

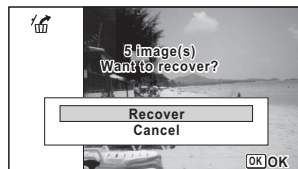

5 Press the OK button.

The files are recovered.



- Recovered images and sound files have the same file name as before they were deleted.
- Up to a maximum of 999 deleted image files can be recovered.

Protecting Images and Sound Files from Deletion (Protect)

You can protect stored images and sound files from being accidentally deleted.

1 Enter mode and use the four-way controller (◀▶) to choose the image you want to protect.

2 Press the four-way controller (▼).

The Playback Mode Palette appears.

- 3** Use the four-way controller (▲▼◀▶) to select  (Protect).



- 4** Press the OK button.

The screen for selecting [Single Image/Sound] or [All Images/Sounds] appears.

- 5** Use the four-way controller (▲) to select [Single Image/Sound].

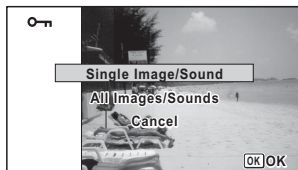

- 6** Press the OK button.

The message [Protects this image/sound] appears.

To protect another image or sound file, use the four-way controller (◀▶) to select another image or sound file.

- 7** Use the four-way controller (▲) to select [Protect].

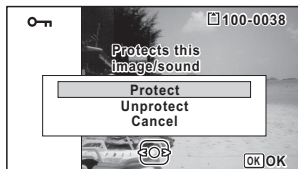

- 8** Press the OK button.

The selected image or sound file is protected.

To protect other images or sound files, repeat Steps 5 to 8.

Select [Cancel] to exit the Protect settings.



- To cancel the Protect setting, select [Unprotect] in step 7.
-  appears on the protected images and sound files during playback.
- The maximum number of images and sound files you can protect in succession with [Single Image/Sound] is 99.

To Protect All Images and Sound Files

- 1** Select [All Images/Sounds] in step 5 on p.182.



- 2** Press the OK button.

- 3** Use the four-way controller (▲) to select [Protect].

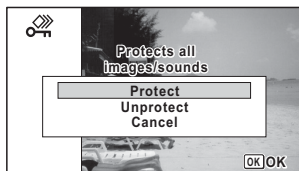

- 4** Press the OK button.

All the images and sound files are protected and the screen shown in Step 1 reappears.

- 5** Use the four-way controller (▲▼) to select [Cancel] and press the OK button.

The Playback Mode Palette reappears.



Protected images and sound files will be deleted when the SD Memory Card is formatted (p.232).



To cancel the Protect setting on all your images and sound files, select [Unprotect] in step 3.

Connecting the Camera to AV Equipment

You can connect the camera to a TV or other device with a video IN jack or HDMI terminal and playback images.



- The power lamp on the camera lights up during a connection.
- If you intend to use the camera continuously for a long period, use of the AC adapter kit K-AC88 (optional) is recommended. (p.43)
- For AV equipment with multiple video IN jacks, check the operating manual of the AV device, and select the video IN jack to which the camera is connected.
- You cannot output composite and HDMI video at the same time.
- The camera display turns off while the camera is connected to AV equipment.
- You cannot adjust the volume on the camera when connected to an AV device. Adjust the volume on the AV device.
- When the camera is connected to an AV device, you can switch the images with the remote control (optional).

4

Playing Back and Deleting Images

Connecting the Camera to a Video IN Jack

By using the supplied AV cable (I-AVC7), you can capture and playback images on equipment with a video IN jack, such as a TV.

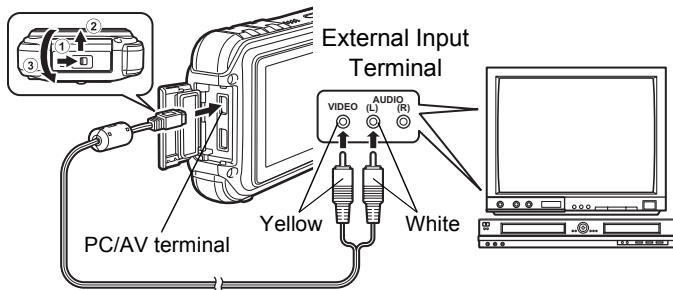

1 Turn the AV device and camera off.

2 Open the terminal cover.

Move the terminal cover lock lever in the direction shown by ①, slide the cover in the direction shown by ② and open the cover in the direction shown by ③.

3 Connect the AV cable to the PC/AV terminal.

4 Connect the other ends of the AV cable (yellow: video, white: audio) to the video input terminal and audio input terminal of the AV device.

When using stereo sound equipment, insert the sound terminal into the L (white) terminal.

5 Turn the AV device on.

When the device that the camera is connected to and the device that plays back images are different, turn both devices on.

When viewing images on AV equipment with multiple video input terminals (such as a TV), refer to the operation manual of the device and select the video input terminal to which to connect the camera.

6 Turn the camera on.



- Depending on the country or region, images and sound files may fail to be played back if the video output format is set different from the one in use there. If this happens, change the video output format setting (p.246).
- The camera's AV output is output at normal resolution.
To watch movies shot at 1280i or 1280p at HDTV resolution, output the movies as HDMI or transfer them to a computer (p.186).



Close the terminal cover securely when not using the terminal.

<How to close the terminal cover>

Close the cover in the opposite direction indicated by ③. While lightly pressing on the terminal cover, slide it away from ② until it clicks.

Connecting the Camera to an HDMI Terminal

Use a commercially available HDMI cable to connect the camera to a device with an HDMI terminal.

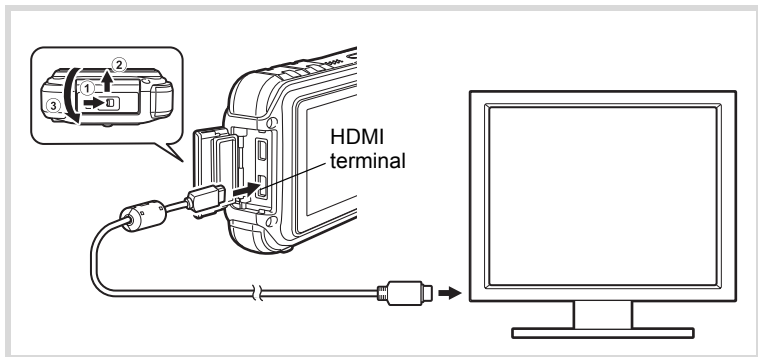

1 Turn the AV device and camera off.

2 Open the terminal cover.

Move the terminal cover lock lever in the direction shown by ①, slide the cover in the direction shown by ② and open the cover in the direction shown by ③.

3 Connect the HDMI cable to the HDMI terminal.

4 Connect the other end of the HDMI cable to the HDMI IN jack on the AV device.

5 Turn the AV device and camera on.

The camera information is displayed on the screen of the connected AV device.



- The camera has a Type D (Micro) HDMI terminal. Use a commercially available HDMI cable that matches your AV device.
- When connecting to an AV device with an HDMI terminal, only the playback mode can be used.
- If you playback the movie by connecting the camera to an AV device with a commercially available HDMI cable, set the output format to "Selecting the HDMI Output Format" (p.247).

Caution

Close the terminal cover securely when not using the terminal.

<How to close the terminal cover>

Close the cover in the opposite direction indicated by ③. While lightly pressing on the terminal cover, slide it away from ② until it clicks.

Memo

5 Editing and Printing Images

Editing Images	190
Setting the Printing Service (DPOF)	219

About Printing

You can print pictures taken with the camera in the following ways.

1. Go to a photo processing lab
2. Use a printer that has an SD Memory Card slot to print directly from the SD Memory Card
3. Use the software that is available on your computer to print images

Changing the Image Size (Resize)

By changing the size and quality of a selected image, you can make the file size smaller than the original. You can use this function to continue taking pictures when the SD Memory Card or the built-in memory is full, by making the images smaller and overwriting the original images to make more space available.



- Panoramic images and movies cannot be resized.
- You cannot select a larger resolution and higher Quality Level than that of the original image.

1 Enter the mode and use the four-way controller (◀▶) to choose the image you want to resize.

2 Press the four-way controller (▼).

The Playback Mode Palette appears.

3 Use the four-way controller (▲▼◀▶) to select (Resize).

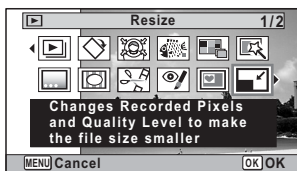

4 Press the **OK** button.

The screen for choosing the image size appears.

5 Select [Recorded Pixels] and [Quality Level].

Use the four-way controller (◀▶) to choose the size and quality.

Use the four-way controller (▲▼) to switch between [Recorded Pixels] and [Quality Level].



6 Press the OK button.

A confirmation dialog for overwriting the image appears. If the selected image is protected, the processed image is saved as a new image and the following confirmation does not appear.

7 Use the four-way controller (▲▼) to select [Overwrite] or [Save as].

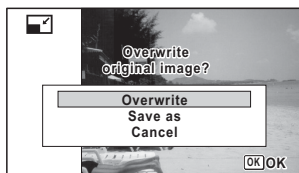

8 Press the OK button.

The resized image is saved.

Cropping Images

You can delete the unwanted part of a picture and save the cropped image as a separate image.



Panoramic images and movies cannot be resized.

1 Enter the [Play] mode and use the four-way controller (◀▶) to choose the image you want to crop.

2 Press the four-way controller (▼).

The Playback Mode Palette appears.

3 Use the four-way controller (▲▼◀▶) to select [Cropping].

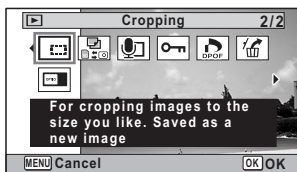



4 Press the OK button.

The cropping screen appears.

The largest size of the cropped image is shown with a green frame on the screen. The cropped image cannot be larger than this cropping frame size.

5 Choose the cropping area.

The following operations move the green frame and set the area for cropping on the screen.

Zoom button ( /Q)	Changes the size of the cropped section
Four-way controller ()	Moves the cropping position up, down, left and right
Green Button	Rotates the cropping frame <ul style="list-style-type: none"> The button is only displayed when the cropping frame size can be rotated.

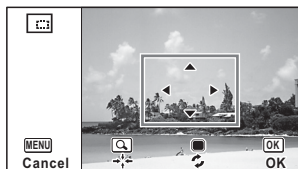

6 Press the OK button.

The cropped image is saved with a new file name.

The number of recorded pixels is selected automatically according to the size of the cropped section. The image is saved at the same quality level as the original.

Processing Images So That Faces Look Smaller

Images are processed to reduce the size of people's faces detected with the Face Detection function (p.81) when taking pictures so that they look smaller.

1 In mode, use the four-way controller () to choose the image you want to edit.

2 Press the four-way controller ()

The Playback Mode Palette appears.

- 3** Use the four-way controller (▲▼◀▶) to select  (Small Face Filter).

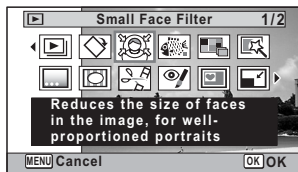

- 4** Press the OK button.

Face detection frames for faces that can be corrected are displayed. Proceed to Step 6 when there is only one detection frame.

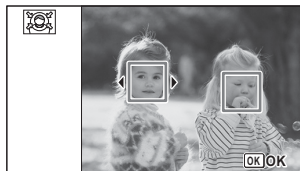

- 5** Use the four-way controller (▲▼◀▶) to select a face to be processed.

A green frame indicates the face that is to be processed.



- 6** Press the OK button.

- 7** Use the four-way controller (◀▶) to change the reduction ratio.

-  Approx. 5%
-  Approx. 7%
-  Approx. 10%



- 8** Press the OK button.

A confirmation dialog for overwriting the image appears.

If the selected image is protected, the processed image is saved as a new image and the following confirmation dialog does not appear.

- 9** Use the four-way controller (▲▼) to select [Overwrite] or [Save as].

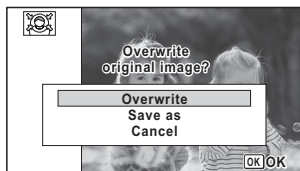

10 Press the OK button.

The camera returns to  mode and the processed image is displayed.



You may not be able to process images in the following situations:

- When the size of face taken in relation to an image is too large or too small
- When faces are located in the edges of an image

In such cases, the face detection frame in Step 4 will not appear.

Using the Digital Filters

This mode lets you change the color tones and perform special processing on a selected image.





B&W	Changes color images to black and white.
Sepia	Processes the image using the sepia filter.
Toy Camera	Images seem to have been taken with a toy camera.
Retro	Images have the feel of old photos with a white border. You can choose from three filters: Original image, amber, and blue.
Color	Processes the image using the selected color filter. You can choose from six filters: red, pink, purple, blue, green, and yellow.
Extract Color	Processes the image using the selected color extraction filter. You can choose from three filters: red, green, and blue.
Color Emphasis	There are 4 filters: Sky Blue/Fresh Green/Delicate Pink/Autumn Leaves.
High Contrast	Adjusts the contrast of the captured images.
Starburst	Processes the image with a special sparkling look achieved by adding cross-like effects to a highlighted area, such as town lights at night, light reflected from water, or other light sources. You can choose from three filters: Cross, Heart, and Star.
Soft	Processes the image into a soft image that appears soft overall.
Fish-eye	Applies a fish-eye lens effect to images.
Brightness Filter	Adjusts the brightness of the image.



Panoramic images, movies or images taken with another camera cannot be edited using Digital Filter function. An error message appears if you choose this function from the Playback Mode Palette and press the **OK** button.

1 Enter the  mode and use the four-way controller ( ) to choose the image you want to edit.

2 Press the four-way controller ().
The Playback Mode Palette appears.

3 Use the four-way controller (   ) to select  (Digital Filter).

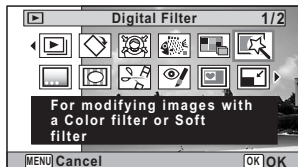

4 Press the **OK** button.
The digital filter selection screen appears.

- 1 B&W
- 2 Sepia
- 3 Toy Camera
- 4 Retro
- 5 Color
- 6 Extract Color
- 7 Color Emphasis
- 8 High Contrast
- 9 Starburst
- 10 Soft
- 11 Fish-eye
- 12 Brightness Filter

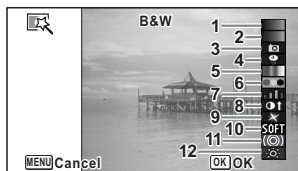

Subsequent steps vary depending on your selection.

5 Use the four-way controller (▲▼) to choose a digital filter you want to use.

The preview image of the results of the filter effect appears.

6 Press the OK button.

A confirmation dialog for overwriting the image appears.

If the selected image is protected, the processed image is saved as a new image and the following confirmation does not appear.

7 Use the four-way controller (▲▼) to select [Overwrite] or [Save as].

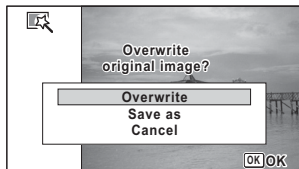

8 Press the OK button.

The images processed with the filter are saved.

To Select a Retro, Color, Extract Color, Color Emphasis or Starburst Filter

- 5 Use the four-way controller (▲▼) to choose the digital filter you want to use.**

The preview image of the results of the filter effect appears.

- 6 Use the four-way controller (◀▶) to choose the effect.**

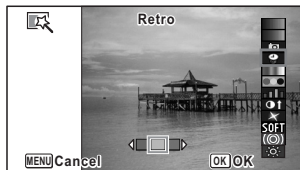

	Four-way controller (◀)	Default Setting	Four-way controller (▶)
Retro	Blue	Original image	Amber

Color	Red ↔ Pink ↔ Purple ↔ Blue ↔ Green ↔ Yellow
Extract Color	Red ↔ Green ↔ Blue
Color Emphasis	Sky Blue ↔ Fresh Green ↔ Delicate Pink ↔ Autumn Leaves
Starburst	Cross ↔ Heart ↔ Star

- 7 Press the OK button.**

A confirmation dialog for overwriting the image appears.

If the selected image is protected, the processed image is saved as a new image and the following confirmation does not appear.

- 8 Use the four-way controller (▲▼) to select [Overwrite] or [Save as].**

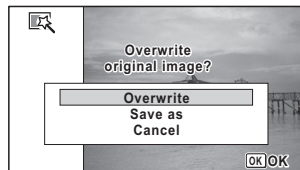

- 9 Press the OK button.**

The images processed with the filter are saved.

To Select a Toy Camera, High Contrast, Fish-eye or Brightness Filter

5 Use the four-way controller (▲▼) to choose a digital filter you want to use.

The preview image of the results of the filter effect appears.

6 Use the four-way controller (◀▶) to adjust the effect.

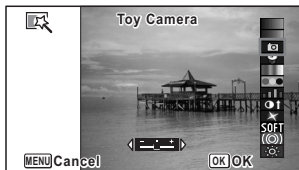

	Four-way controller (◀)	Default Setting	Four-way controller (▶)
Toy Camera	Weak	Standard	Strong
High Contrast	Weak	Standard	Strong
Fish-eye	Weak	Standard	Strong
Brightness Filter	Dark	Standard	Bright

7 Press the OK button.

A confirmation dialog for overwriting the image appears.

If the selected image is protected, the processed image is saved as a new image and the following confirmation does not appear.

8 Use the four-way controller (▲▼) to select [Overwrite] or [Save as].

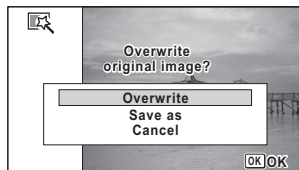

9 Press the OK button.

The images processed with the filter are saved.

Using the Ink Rubbing Filter

You can edit the image to look like an ink rubbing.



The Ink Rubbing Filter cannot be used on the following images.

- Panoramic images or movies
 - Images that have recorded pixels of **5M**, **3.8M16:9**, **3M**, **2.1M16:9**, **1280**, **1024**, or **640**
 - Images taken with other cameras
- An error message appears in step 4.

1 Enter mode and use the four-way controller (**▲▼◀▶**) to choose the image you want to edit.

2 Press the four-way controller (**▼**).
The Playback Mode Palette appears.

3 Use the four-way controller (**▲▼◀▶**) to select (Ink Rubbing Filter).

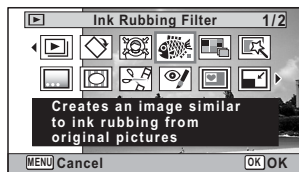

4 Press the **OK** button.
The preview image of the results of the filter effect appears.

5 Use the four-way controller (**◀▶**) to choose the effect.

- Weak
- Standard
- Strong

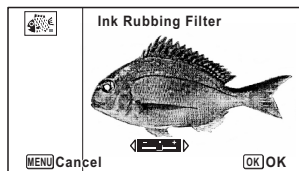

6 Press the **OK** button.

A confirmation dialog for overwriting the image appears.
If the selected image is protected, the processed image is saved as a new image and the following confirmation does not appear.

- 7** Use the four-way controller (▲▼) to select [Overwrite] or [Save as].

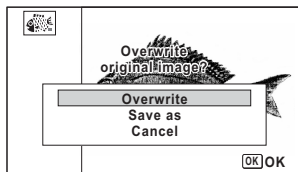

- 8** Press the OK button.

The images processed with the filter are saved.



- The processed images are saved with the recorded pixels of **5M** / **3.8M** 16:9.
- When there is little contrast between the object and the background, the shape of the object may not be sharp depending on the conditions of the original image.

Creating a Collage Image

Make a collage image by placing captured images on a selected pattern.



The collage function cannot be used on the following images.

- Panoramic images or movies
- Images that have recorded pixels of **3M**, **2.1M** 16:9, **1280**, **1024**, or **640**
- Image taken with other cameras

An error message appears in step 4.

- 1** Enter  mode and press the four-way controller (▼).

The Playback Mode Palette appears.

- 2** Use the four-way controller (▲▼◀▶) to select  (Collage).

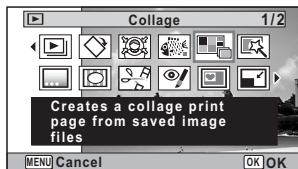

- 3 Press the OK button.**
The item selection screen appears.

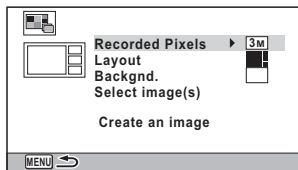

Selecting the Number of Recorded Pixels

- 4 Use the four-way controller (▲▼) to choose the [Recorded Pixels].**

- 5 Press the four-way controller (▶).**
A pull-down menu appears.

- 6 Use the four-way controller (▲▼) to choose the recorded pixels.**

You can choose from **3M** or **2.1M(16:9)**.

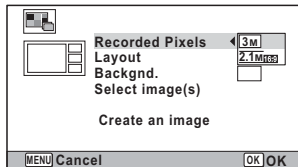

- 7 Press the OK button.**
Returns to the item selection screen.

Selecting the Layout Pattern

- 8 Use the four-way controller (▲▼) to choose the [Layout].**

- 9 Press the four-way controller (▶).**
A pull-down menu appears.

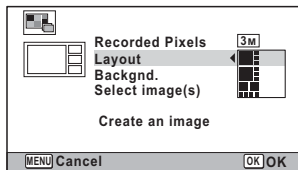

- 10** Use the four-way controller (▲▼) to choose the pattern of layout.

You can choose from 3 patterns of layout (■□/■□□/■□□□).

- 11** Press the OK button.

Returns to the item selection screen.

Selecting the Background

- 12** Use the four-way controller (▲▼) to choose [Backgnd.].

- 13** Press the four-way controller (▶).

A pull-down menu appears.

- 14** Use the four-way controller (▲▼) to choose the background.

You can choose the white background or the black background.

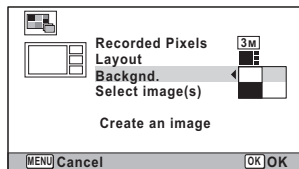

- 15** Press the OK button.

Returns to the item selection screen.

Laying Out the Image

Caution

- The collage function cannot be used on the following images.
 - Panoramic images or movies
 - Images that have recorded pixels of **3M**, **2.1Mpixels**, **1280**, **1024**, or **640**
 - Images taken with other camerasThese images do not appear as selectable items.
- If you select an image with a 16:9 aspect ratio, the black areas appear above and below the image.

16 Use the four-way controller (▲▼) to choose [Select image(s)].

17 Press the four-way controller (▶).

The images to be selected appear.

18 Use the four-way controller (◀▶) to choose the image to include and press the **OK** button.

The selected image is placed in the highlighted area in the guide. The guide appears on the top left of the monitor.



19 Repeat step 18 to lay out the rest images.

20 Press the **●** button.

Returns to the item selection screen.

Saving the Edited Image

- 21** Use the four-way controller (▲▼) to select [Create an image].

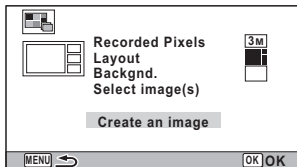

- 22** Press the OK button.

A confirmation dialog for saving the image appears.

- 23** Use the four-way controller (▲) to select [Save].

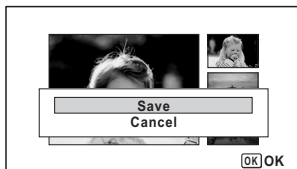

- 24** Press the OK button.

The edited image is saved.



The quality level of the image is fixed at ★★★ (Best).

Red-eye Compensation

You can correct images where the flash has caused the subject to appear with red eyes.



- The red-eye compensation function cannot be used on panoramic images, movies or on images where red eyes cannot be detected on the camera. An error message appears in step 4.
- The red-eye compensation function can only be used with still pictures taken with this camera.

1 Enter the mode and use the four-way controller (◀▶) to choose the image you want to correct.

2 Press the four-way controller (▼).
The Playback Mode Palette appears.

3 Use the four-way controller (▲▼◀▶) to select (Red-eye Compensation).

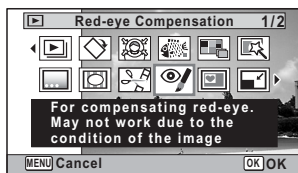

4 Press the OK button.

A confirmation dialog for overwriting the image appears. If the selected image is protected, the processed image is saved as a new image and the following confirmation does not appear.

5 Use the four-way controller (▲▼) to select [Overwrite] or [Save as].

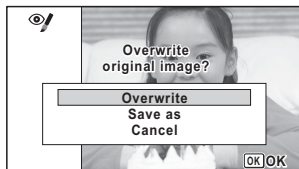

6 Press the OK button.
The edited image is saved.

Adding a Frame (Frame Composite)

This function lets you add a decorative frame to still pictures. There are 90 frames already stored in the camera.



The frame composite function cannot be used on the following images.

- Panoramic images or movies
 - Images that have recorded pixels of **3M**, **2.1M16:9**, **1280**, **1024**, or **640**
- An error message appears in step 4.

1 Enter the  mode and use the four-way controller (**◀▶**) to choose the image to which you want to add a frame.

2 Press the four-way controller (**▼**).

The Playback Mode Palette appears.

3 Use the four-way controller (**▲▼◀▶**) to select  (Frame Composite).

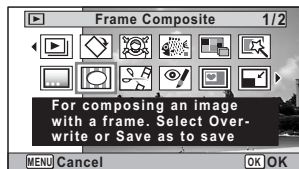

4 Press the **OK** button.

The 12-frame display of the frame selection screen appears.

5 Use the four-way controller (**▲▼◀▶**) to choose a frame.



6 Press the **Q** button.

The selected frame appears in single-image display.

You can choose another frame using either of the following operations.

Four-way controller (◀▶)	Press to choose a different frame.
Zoom button left (⊞)	Press to return to the 12-frame display of the frame selection screen, and then perform step 5 to choose a different frame.



7 Press the **OK** button.

The frame position and size adjustment screen appears.

You can adjust the image using either of the following operations.

Four-way controller (▲▼◀▶)	Press to adjust the position of the image
Zoom button (⊞/Q)	Press to make the image larger or smaller.



8 Press the **OK** button.

A confirmation dialog for overwriting the image appears.

If the selected image is protected, the processed image is saved as a new image and the following confirmation does not appear.

9 Use the four-way controller (▲▼) to select [Overwrite] or [Save as].

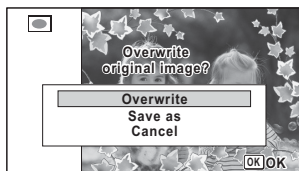

10 Press the **OK** button.

The edited image is saved with the recorded pixels of

3M (2048×1536)/**2.1M** (1920×1080).

Optional Frames

The optional frames are stored in the built-in memory in the Optio W90. These optional frames are deleted if the files on the built-in memory are deleted with a computer or the built-in memory is formatted. To reload the optional frames into the built-in memory, copy the files from the CD-ROM (S-SW102) supplied with the camera.

To Copy Frames

- 1 Remove the SD Memory Card from the camera.**
If you leave the SD Memory Card in the camera, the frames will be copied onto the card, not into the camera's built-in memory.
- 2 Connect the camera to the computer using the provided USB cable (I-USB7).**
Refer to "Connecting to a Computer" (p.261) for instructions on connecting the camera to a computer.
- 3 When the device detection window opens, click [Cancel].**
- 4 Insert the CD-ROM (S-SW102) into the CD-ROM drive.**
- 5 When the installer window opens, click [EXIT].**
- 6 If there is not already a "FRAME" folder in the root directory of the camera (Removable Disk), create the folder.**
- 7 Copy the desired files from the FRAME folder in the root directory of the CD-ROM to the FRAME folder on the camera (Removable Disk).**
For information on working with files on your computer, refer to the instruction manual supplied with the computer.
- 8 Disconnect the USB cable from the computer and camera.**
Refer to "Connecting to a Computer" (p.261) for instructions on disconnecting the camera from a computer.

- Frames can be stored both in the built-in memory and on the SD Memory Cards, but using large numbers of frames may slow down processing times.

To Use a New Frame

The frames downloaded from the PENTAX website or other source can be used for adding a frame to pictures.



- Extract the downloaded frame and copy it to the FRAME folder in the built-in memory or the SD Memory Card.
- The FRAME folder is created when the SD Memory Card is formatted with this camera.
- For more information on downloading, refer to the PENTAX website.

Overlaying Your Original Frame on an Image

You can overlay your original frame (decorative frame) on an image. You can select the type and color of an original frame and its position. Text can also be entered.

Frame

Type of original frame	Blur/Edge Composite
Frame Type	<input type="checkbox"/> (All sides)/ <input type="checkbox"/> (Upper and lower sides)/ <input type="checkbox"/> (Right and left sides)/ <input type="checkbox"/> (Upper side)/ <input type="checkbox"/> (Lower side)/ <input type="checkbox"/> (Left side)/ <input type="checkbox"/> (Right side)
Color	White/Gray/Black/Pink/Pumpkin/Dark red/Dark green

Text Stamp

Available characters	A – Z, a – z, 0 – 9, Symbols
Display Position	<input type="checkbox"/> (Upper-left)/ <input type="checkbox"/> (Upper-center)/ <input type="checkbox"/> (Upper-right)/ <input type="checkbox"/> (Lower-left)/ <input type="checkbox"/> (Lower-center)/ <input type="checkbox"/> (Lower-right)
Color	White/Gray/Black/Pink/Pumpkin/Dark red/Dark green



The Original Frame function cannot be used on panoramic images, images recorded with **3M**/**2.1M1639**/**1280**/**1024**/**640** in [Recorded Pixels], or movies. An error message appears in Step 4.

1 In  mode, use the four-way controller (◀▶) to choose the image you want to add a frame.

2 Press the four-way controller (▼).

The Playback Mode Palette appears.

3 Use the four-way controller (▲▼◀▶) to select  (Original Frame).

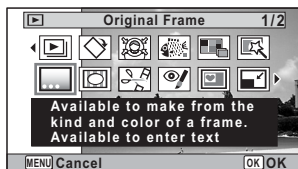

4 Press the OK button.

The original frame type selecting screen appears.

5 Use the four-way controller (▲▼) to select an original frame type, and press the OK button.

The frame setting screen appears.

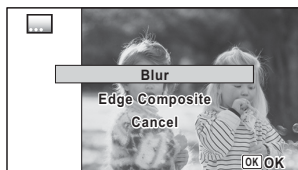

6 Use the four-way controller (▲▼) to select [Frame Type], and press the four-way controller (▶).

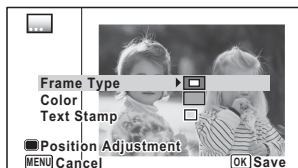

7 Use the four-way controller (▲▼) to select a frame type, and press the four-way controller (◀).

8 Set [Color] in the same way as in Steps 6 and 7.

9 Adjust the position of the frame and image.

For details, refer to “To Adjust the Position of the Frame and an Image” (p.211).

10 Use the four-way controller (▲▼) to select [Text Stamp], and press the four-way controller (▶).

The Text Stamp screen appears.

When you do not enter characters, proceed to Step 12.

11 Set up the text stamp.

For details, refer to “To Set Up Text Stamp” (p.212).

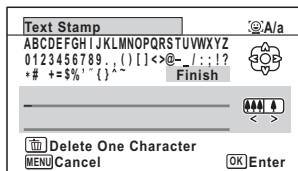

12 Press the OK button.

A confirmation dialog for overwriting the image appears.

If the selected image is protected, the processed image is saved as a new image and the following confirmation dialog does not appear.

13 Use the four-way controller (▲▼) to select [Overwrite] or [Save as].

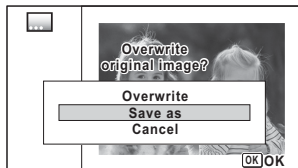

14 Press the OK button.

The edited image is saved with the recorded pixels of

5M (2592×1944)/3.8M (2592×1464).

To Adjust the Position of the Frame and an Image

1 Press the Green button.

The frame position adjustment screen appears.

Four-way controller (▲▼◀▶)	Press to adjust the position of the frame
Zoom button right (Q)	Press to make the frame larger
Zoom button left (Q)	Press to make the frame smaller

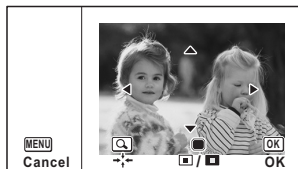

2 Press the Green button.

The image position adjustment screen appears.

Four-way controller (▲▼◀▶)	Press to adjust the position of the image
Zoom button right (Q)	Press to make the image larger
Zoom button left (☒)	Press to make the image smaller

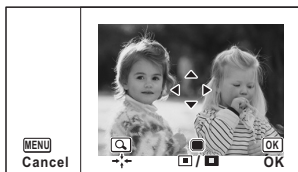

3 Press the OK button.

The screen returns to the original screen.

To Set Up Text Stamp

1 Use the four-way controller (▲▼◀▶) to select a character and press the OK button.

The selected character is input.
Up to 52 characters can be input.

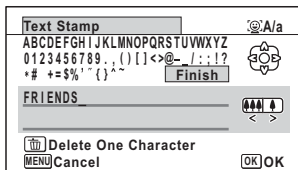

Ⓞ button	Press to switch between upper and lower case
Zoom button right (Q)	Press to move the cursor to the right
Zoom button left (☒)	Press to move the cursor to the left
Green button	Press to delete the character

2 Use the four-way controller (▲▼◀▶) to select [Finish] and press the OK button.

- 3** Use the four-way controller (▲▼) to select [Display Position] and press the four-way controller (▶).

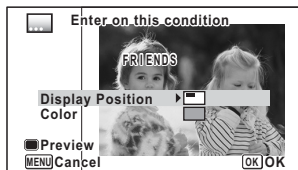

- 4** Use the four-way controller (▲▼) to select the display position and press the four-way controller (◀).
- 5** Use the four-way controller (▲▼) to select [Color] and press the four-way controller (▶).
- 6** Use the four-way controller (▲▼) to select the color and press the four-way controller (◀).

To View the Preview Screen



- 1** Press the Green button.
The preview screen appears.



- 2** Press the MENU button.
The screen returns to the original screen.
- 3** Press the OK button.
Proceed to Step 12 on p.211.





Editing Movies

You can select a frame from the recorded movie to save as a still picture, divide a movie into two, or add a title picture to a movie.

1 Enter the  mode and use the four-way controller ( ) to choose the movie you want to edit.

2 Press the four-way controller () .

The Playback Mode Palette appears.

3 Use the four-way controller (   ) to select  (Movie Edit).

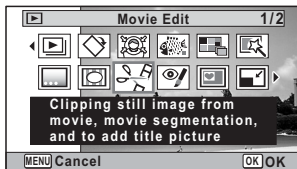

4 Press the **OK** button.

The movie edit selection screen appears.

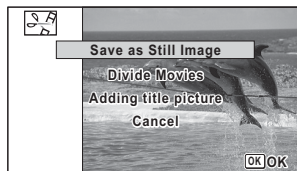

To Save a Frame from a Movie as a Still Picture

5 Select [Save as Still Image] on the movie edit selection screen.

6 Press the **OK** button.

The screen appears for selecting a frame to be saved as a still picture.

- 7** Use the four-way controller (▲▼◀▶) to choose the frame you want to save.

- ▲ Plays or pauses the movie
- ▼ Stops the movie and returns to the first frame
- ◀ Reverses the movie frame by frame
- ▶ Advances the movie frame by frame

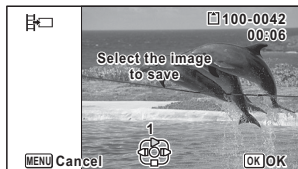

- 8** Press the OK button.

The selected frame is saved as a still picture.

To Divide a Movie

- 5** Select [Divide Movies] on the movie edit selection screen.

- 6** Press the OK button.

The screen for choosing the dividing position appears.

- 7** Use the four-way controller (▲▼◀▶) to determine the dividing position.

- ▲ Plays or pauses the movie
- ▼ Stops the movie and returns to the first frame
- ◀ Reverses the movie frame by frame
- ▶ Advances the movie frame by frame

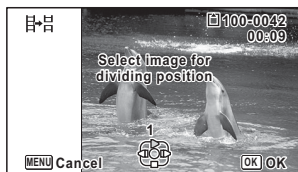

- 8** Press the OK button.

A confirmation dialog appears.

- 9** Use the four-way controller (▲) to select [Divide].

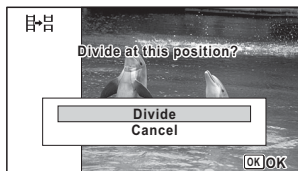

10 Press the OK button.

The movie is divided at the specified position, the two portions are saved as new files, and the original one is deleted.



The protected movies cannot be divided.

To Add a Title Picture to a Movie

5 Select [Adding title picture] on the movie edit selection screen.

6 Press the OK button.

The screen appears for selecting a title picture.



7 Use the four-way controller (◀▶) to choose the desired title picture.

Only images available for use with the title picture are displayed.

8 Press the OK button.

The screen appears for confirming the position of the title picture.

9 Use the four-way controller (▲▼) to select the position.

-  Adds the title picture to the beginning of the movie
-  Adds the title picture to the end of the movie

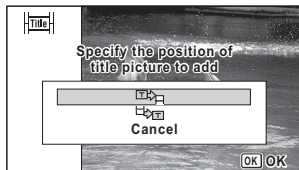

10 Press the OK button.

The selected picture is saved as the title picture.



- When a title picture is added to the beginning of a movie: When the movie is played back, the still picture is played back for three seconds, and then the movie is played back. The still picture registered as title picture is used as the thumbnail of the movie.
When a title picture is added to the end of a movie: When the movie is played back, the movie is played back, and then the still picture is played back for three seconds. The thumbnail of the movie is not changed by adding a title picture to the end of the movie.
- Only a still image with the same aspect ratio as the movie can be set as the title picture.

Copying Images and Sound Files

You can copy images and sound files from the built-in memory to the SD Memory Card and vice versa. This function can only be selected when an SD Memory Card has been inserted in the camera.



Make sure that the camera is turned off before inserting or removing the SD Memory Card.

1 In mode, press the four-way controller (▼).

The Playback Mode Palette appears.

2 Use the four-way controller (▲▼◀▶) to select (Image/Sound Copy).

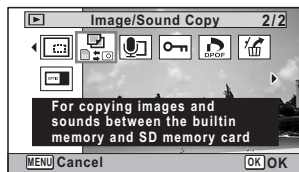

3 Press the OK button.

The copying method selection screen appears.

To Copy Files from the Built-in Memory to the SD Memory Card

All the images and sound files in the built-in memory are copied to the SD Memory Card at once. Before copying the images, make sure that there is enough space on the SD Memory Card.

- 4 Use the four-way controller (▲) to select [● → SD].**

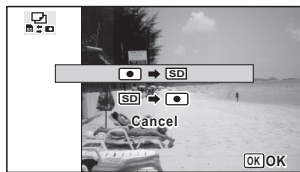

- 5 Press the OK button.**

All the images and sound files are copied to the SD Memory Card.

To Copy Files from the SD Memory Card to the Built-in Memory

Selected images and sound files from the SD Memory Card are copied to the built-in memory one at a time.

- 4 Use the four-way controller (▲ ▼) to select [SD → ●].**

- 5 Press the OK button.**

- 6 Use the four-way controller (◀ ▶) to select the image/sound file you want to copy.**



- 7 Press the OK button.**

The selected image/sound file is copied to the built-in memory. To copy other images or sound files, repeat Steps 4 to 7. Select [Cancel] to exit the settings.



- If sound (Voice Memo) has been recorded with the image, the sound file is copied with the image.
- When a file is copied from the SD Memory Card to the built-in memory, it is assigned a new file name.

Setting the Printing Service (DPOF)

DPOF (Digital Print Order Format) is the format for storing print order data on still pictures captured with a digital camera. Once the print order data has been stored, the pictures can be printed according to the DPOF settings using a DPOF-compatible printer or photo processing lab. DPOF cannot be set for movies or sound-only files.

Caution

If the picture already has the date and/or time imprinted on it (p.145), do not set [Date] (On) in DPOF settings. If you select (On), the imprinted date and/or time may overlap.

Printing a Single Image

Set the following items for each image.

Copies	For setting the number of prints. You can print up to 99 copies.
Date	Specify whether you want the date inserted on the print or not.

1 In mode, press the four-way controller (▼).

The Playback Mode Palette appears.

2 Use the four-way controller (▲▼◀▶) to select (DPOF).

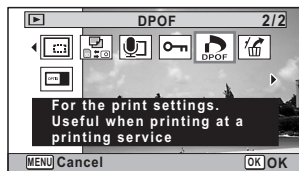

3 Press the OK button.

The screen for selecting [Single Image] or [All Images] appears.

4 Use the four-way controller (▲▼) to select [Single Image].



5 Press the OK button.

The message [Applies DPOF settings to this image] appears.

To make DPOF settings for another image, use the four-way controller (◀▶) to select another image.

If DPOF settings have already been made for an image, the previous number of copies and date setting ((On) or (Off)) will be displayed.

6 Use the four-way controller (▲▼) to choose the number of copies.

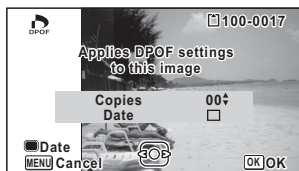

7 Use the Green button to choose whether to insert the date or not.

- (On) The date will be imprinted.
- (Off) The date will not be imprinted.

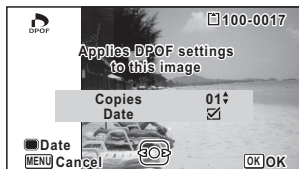

To continue setting DPOF print order data, use the four-way controller (◀▶) to choose another image and repeat steps 6 and 7.

8 Press the OK button.

The setting is saved and the screen shown in Step 4 reappears.



Depending on the printer or printing equipment at the photo processing lab, the date may not be imprinted on the pictures even if On is selected in the DPOF settings.



To cancel DPOF settings, set the number of copies to [00] in step 6 and press the **OK** button.

Printing All Images

When you choose the number of copies and whether or not to insert the date, the settings are applied to all the images stored in the camera.

1 Select **[All Images]** in step 4 on p.220.

2 Press the **OK** button.

The message [Applies DPOF settings to all images] appears.

3 Choose the number of copies and whether to insert the date or not.

Refer to steps 6 and 7 in “Printing a Single Image” (p.220) for details of how to make the settings.

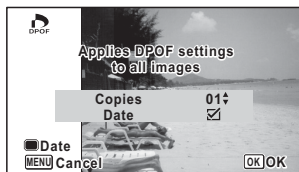

4 Press the **OK** button.

The settings for all the images are saved and the camera returns to the DPOF setting screen.



- The number of copies specified in the DPOF settings applies to all the images. Before printing, check that the number is correct.
- Settings for single images are canceled when settings are made with [All Images].

Memo

6 Recording and Playing Back Sound

Recording Sound (Voice Recording Mode)	224
Adding a Voice Memo to Images	228

Recording Sound (Voice Recording Mode)

You can record sound with the camera. The microphone is located on top of the camera. When recording sound, aim the microphone at the sound source to obtain the best sound quality.

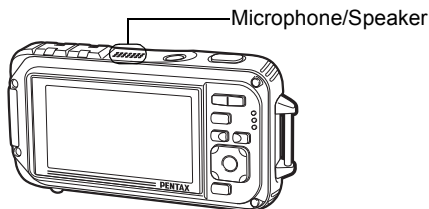

Setting Voice Recording

To use the Voice Recording function, register Voice Recording to the Green Button.



When the shooting mode is set to **●** (Green) Mode, [Green Button] settings cannot be configured on the [Rec. Mode] menu. To configure the settings, first switch to a mode other than **●**.

- 1 Press the MENU button in **●** mode.**
The [Rec. Mode] menu appears.
- 2 Press the four-way controller (▲▼) to select [Green Button].**
- 3 Press the four-way controller (▶).**
A pull-down menu appears.
- 4 Use the four-way controller (▲▼) to select [Voice Recording] and press the OK button.**
- 5 Press the MENU button.**
The Voice Recording function is registered to the Green Button.

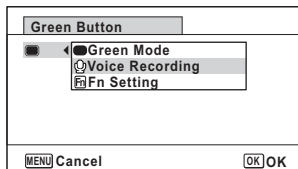

Recording Sounds

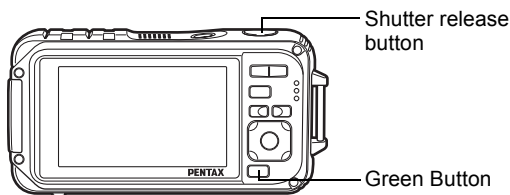

1 Press the Green button in mode.

The camera enters Voice Recording mode. The remaining recordable time and the recording time of the current file appear on the display.

- 1 Recording time
- 2 Remaining recordable time

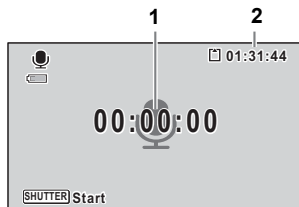

2 Press the shutter release button fully.

Recording starts. The self-timer lamp and REC icon (red) flash during recording.

When the Green button is pressed during recording, an index is added to the current sound file.

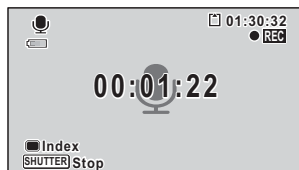

3 Press the shutter release button fully.

Recording stops.





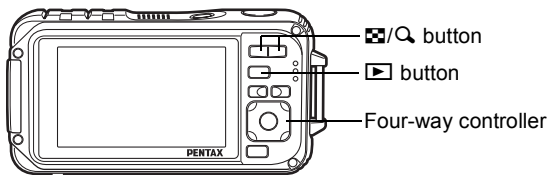

- If you press and hold down the shutter release button for more than one second in step 2, recording continues until you take your finger off the button. This is useful for recording short sounds.
- Sound is saved in WAVE monaural files.
- In  (Voice Recording) mode, pressing the **OK/DISPLAY** button only turns off the LCD and changes the display to Normal Display.

Playing Back Sound

You can play back the sound files you made with Voice Recording.





- 1 Press the  button.**
- 2 Use the four-way controller ( ) to choose a sound file to play back.**
- 3 Press the four-way controller ()**

Playback starts.

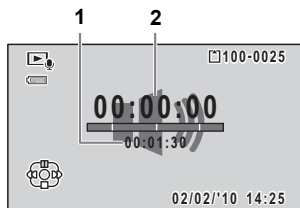

- 1 Total file recording time
- 2 Playback time





The following operations can be performed during playback.

- | | |
|---|----------------------|
| Four-way controller () | Pauses playback |
| Zoom button () | Increases the volume |
| Zoom button () | Reduces the volume |



If there are no recorded indexes:

- | | |
|---|------------------------|
| Four-way controller () | Reverses playback |
| Four-way controller () | Fast forwards playback |

If there are recorded indexes:

- | | |
|---|---|
| Four-way controller () | Plays back starting from the previous index |
| Four-way controller () | Plays back starting from the next index |

The following operations can be performed while playback is paused.

- | | |
|---|----------------------------|
| Four-way controller () | Resumes playback |
| Four-way controller () | Rewinds approx. 5 seconds |
| Four-way controller () | Advances approx. 5 seconds |

4**Press the four-way controller (▼).**

Playback stops.

Adding a Voice Memo to Images

You can add a voice memo to your still pictures.

Recording a Voice Memo

1 Enter  mode and use the four-way controller (◀▶) to choose the still picture to which you want to add a voice memo.

2 Press the four-way controller (▼).
The Playback Mode Palette appears.

3 Use the four-way controller (▲▼◀▶) to select  (Voice Memo).

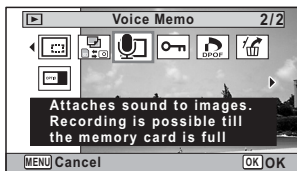

4 Press the **OK** button.
Recording starts.

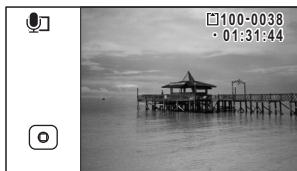

5 Press the **OK** button.
Recording stops.



- A voice memo cannot be added to the image that already has a voice memo. Delete the old voice memo (p.177) and record a new one.
- A voice memo cannot be added to protected images (p.181).

Playing Back a Voice Memo

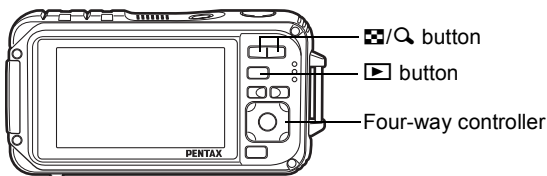

- 1** Enter mode and use the four-way controller (◀▶) to choose the still picture with the voice memo that you want to play back.

appears on images with voice memos in single-image display.

- 2** Press the four-way controller (▲).

Playback starts.

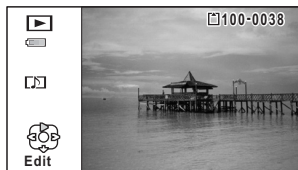

The following operations can be performed during playback.

- | | |
|-----------------|----------------------|
| Zoom button (Q) | Increases the volume |
| Zoom button (Q) | Reduces the volume |

- 3** Press the four-way controller (▼).

Playback stops.

To Delete a Sound File p.177

7 Settings

Camera Settings	232
-----------------------	-----

Formatting an SD Memory Card

Formatting deletes all the data on the SD Memory Card.



Be sure to use this camera to format (initialize) an SD Memory Card that is unused or has been used on other cameras or digital devices.



- Do not remove an SD Memory Card while it is being formatted. This may damage the card and make it unusable.
- Formatting deletes protected images and any data recorded on the card with a computer or any camera.
- SD Memory Cards formatted on a computer or device other than this camera cannot be used. Be sure to format the card with the camera.
- The built-in memory cannot be formatted except when an error occurs.

1 Press the **MENU** button in mode.

The [ Setting] menu appears.

When you press the **MENU** button in  mode, press the four-way controller () once.

2 Use the four-way controller () to select [**Format**].

3 Press the four-way controller ()

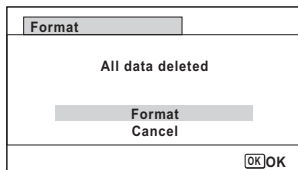

The [Format] screen appears.

4 Use the four-way controller () to select [**Format**].



5 Press the **OK** button.

Formatting starts.



When formatting is completed, the camera returns to  mode or  mode.

Changing the Sound Settings

You can adjust the volume of operation sounds and change the type of sound.

1 Press the **MENU** button in mode.

The [ Setting] menu appears.

When you press the **MENU** button in  mode, press the four-way controller () once.

2 Use the four-way controller () to select [Sound].

3 Press the four-way controller ()

The [Sound] screen appears.

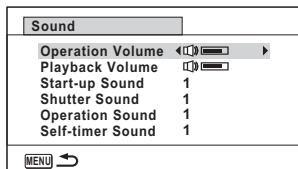

To Change the Operation Volume/Playback Volume

4 Use the four-way controller () to select [Operation Volume].

5 Use the four-way controller () to adjust the volume.

Set the volume to  to mute the start-up sound, shutter sound, operation sound, and self-timer sound.

6 Change [Playback Volume] in the same way as in steps 4 and 5.

To Change the Sound Type

4 Use the four-way controller () to select [Start-up Sound].

5 Press the four-way controller ()

A pull-down menu appears.

6 Use the four-way controller () to select the sound type.

Choose from [1], [2], [3], [4], [Off], or [USER].

- 7** Press the **OK** button.
- 8** Set **[Shutter Sound]**, **[Operation Sound]** and **[Self-timer Sound]** in the same way as in steps 4 to 7.
- 9** Press the **MENU** button.
The screen returns to the [**↖** Setting] menu.

Changing the Sound (Using a Recorded Sound File)

You can use a sound recorded by the camera for sound settings. The first two seconds of the selected sound file will be played as the [USER] sound.

- 1** Select **[USER]** in step 6 in “To Change the Sound Type”.
- 2** Press the **OK** button.

The playback screen for the recorded sound files appears.

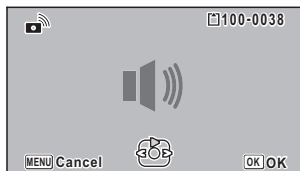

- 3** Use the four-way controller (**◀ ▶**) to select a sound file.
Play back the selected file to confirm.
Four-way controller (**▲**): Plays back the first two seconds of the sound file.
Four-way controller (**▼**): Stops playback.
- 4** Press the **OK** button.
The selected sound is set as the [USER] sound.
- 5** Set **[Shutter sound]**, **[Operation Sound]** and **[Self-timer Sound]** in the same manner.
- 6** Press the **MENU** button.
The screen returns to the [**↖** Setting] menu.





The Sound settings are saved when the camera is turned off.

Changing the Date and Time

You can change the initial date and time settings (p.55). You can also set the style in which the date appears on the camera.

1 Press the **MENU** button in mode.

The [ Setting] menu appears.

When you press the **MENU** button in  mode, press the four-way controller () once.

2 Use the four-way controller () to select [Date Adjustment].

3 Press the four-way controller ()

The [Date Adjustment] screen appears.

Date Adjustment	
Date Format	mm/dd/yy 24h
Date	01/01/2010
Time	00:00
Settings complete	
MENU Cancel	

4 Press the four-way controller ()

The frame moves to [mm/dd/yy].

Depending on the initial setting or previous setting, [dd/mm/yy] or [yy/mm/dd] may be displayed.

5 Use the four-way controller () to choose the date and time display style.

Choose from [mm/dd/yy], [dd/mm/yy] or [yy/mm/dd].

Date Adjustment	
Date Format	mm/dd/yy 24h
Date	01/01/2010
Time	00:00
Settings complete	
MENU Cancel	

6 Press the four-way controller ()

The frame moves to [24h].

- 7** Use the four-way controller (▲▼) to select [24h] (24-hour display) or [12h] (12-hour display).

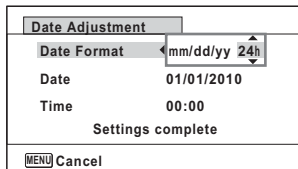

- 8** Press the four-way controller (▶).
The frame returns to [Date Format].

- 9** Press the four-way controller (▼).
The frame moves to [Date].

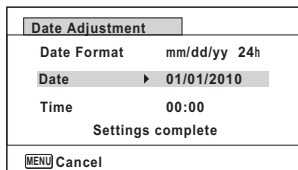

- 10** Press the four-way controller (▶).
The frame moves to one of the following items depending on the date style set in step 5.
- Month for [mm/dd/yy]
 - Day for [dd/mm/yy]
 - Year for [yy/mm/dd]
- The following operations and screens use [mm/dd/yy] as an example. The operations are the same even if another date style has been selected.

- 11** Use the four-way controller (▲▼) to change the month.

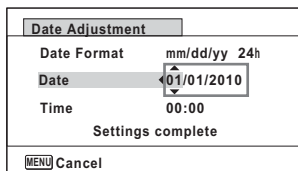

- 12** Press the four-way controller (▶).
The frame moves to the day field. Use the four-way controller (▲▼) to change the day. After changing the day, change the year in the same manner.

13 Change the time in the same way as in steps 8 to 12.

If you selected [12h] in step 7, the setting switches between am and pm corresponding to the time.

14 Press the four-way controller (▼) to select [Settings complete].

Date Adjustment	
Date Format	mm/dd/yy 24h
Date	01/01/2010
Time	00:00
Settings complete	
MENU Cancel	OK OK

15 Press the OK button.

The date and time settings are saved and the screen returns to the [↶ Setting] menu.



When you press the **OK** button in step 15, the camera clock is reset to 00 seconds. To set the exact time, press the **OK** button when the time signal (on the TV, radio, etc.) reaches 00 seconds.

Setting the Alarm

You can set the alarm to ring at a specified time.

You can choose whether the alarm will ring at the same time every day or only once at the set time.

Setting the Alarm

1 Press the MENU button in [▶] mode.

The [↶ Setting] menu appears.

When you press the **MENU** button in [▶] mode, press the four-way controller (▶) once.

2 Use the four-way controller (▲▼) to select [Alarm].

3 Press the four-way controller (▶).

The Alarm screen appears.

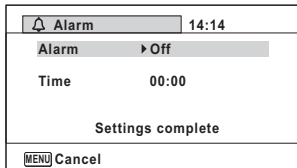

4 Press the four-way controller (▶).

A pull-down menu appears.

5 Use the four-way controller (▲▼) to select the alarm.

Choose from [Off], [Once], or [Everyday].

6 Press the OK button.

7 Press the four-way controller (▼).

The frame moves to the [Time] field.

8 Press the four-way controller (▶).

The frame moves to the hour field.

9 Use the four-way controller (▲▼) to change the hour, then press (▶).

The frame moves to the minute field.

Change the minutes in the same manner.

10 Press the OK button.

11 Press the four-way controller (▼).

The frame moves to [Settings complete].

12 Press the OK button.

When the alarm is set to [Off], the settings are saved and the screen returns to the [Setting] menu.

Check that [Alarm] is set to (Off). When the alarm is set to [Once] or [Everyday], [Alarm is set] is displayed and the power turns off.

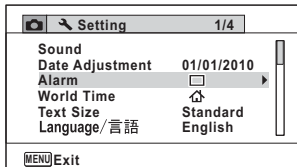

Checking the Alarm

1 Use the four-way controller (▲▼) to select [Alarm] on the [↶ Setting] menu.

Check that [Alarm] is set to (On).

2 Press the four-way controller (▶).

The Alarm screen appears.

Check the alarm frequency and time.

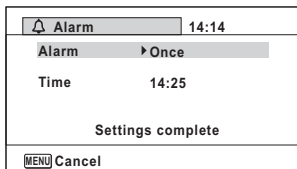

3 Press the MENU button twice.

The camera returns to  mode or  mode.

Turning the Alarm Off



The Clock mode screen appears and the alarm rings for one minute when the set time is reached while the camera is turned off.

You can stop the alarm by pressing any button on the camera while the alarm is ringing.



- The alarm will not ring if the camera is on when the set time is reached.
- Even if an alarm is set, the alarm will not ring while interval shooting is being performed.



Setting the World Time

The date and time selected in “Setting the Date and Time” (p.55) and “Changing the Date and Time” (p.235) serve as the  (Hometown) date and time. By using the world time function, you can display the time in a city other than the Hometown ( Destination). This is useful when taking pictures in a different time zone.

To Set the Destination

1 Press the MENU button in mode.

The [Setting] menu appears.

When you press the MENU button in  mode, press the four-way controller () once.

2 Use the four-way controller () to select [World Time].

3 Press the four-way controller ()

The [World Time] screen appears.

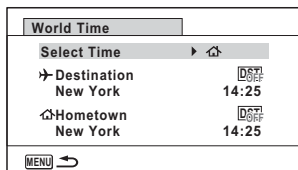

4 Use the four-way controller () to select (Destination).

5 Press the four-way controller ()

The [Destination] screen appears. The city that is currently selected blinks on the map.

6 Use the four-way controller () to change the Destination city.

The current time, location and time difference of the selected city appear.

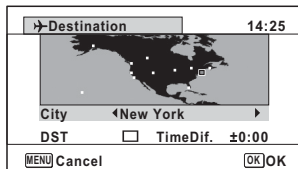

7 Use the four-way controller () to select [DST].

8 Use the four-way controller () to select (On) or (Off).

Select (On) if the Destination city uses daylight saving time.

9 Press the OK button.

The [World Time] setting is saved.

10 Press the MENU button twice.

The camera returns to mode or mode.



Select (Hometown) in step 4 to set the city and DST setting for the Hometown city.

To Display the Time of the Destination (Select Time)

1 Press the MENU button in mode.

The [Setting] menu appears.

When you press the MENU button in mode, press the four-way controller () once.

2 Use the four-way controller () to select [World Time].

3 Press the four-way controller ().

The [World Time] screen appears.

4 Use the four-way controller () to select [Select Time].

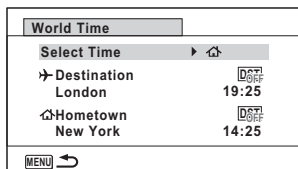

5 Press the four-way controller ().

A pull-down menu appears.

6 Use the four-way controller () to select (Destination) or (Hometown).

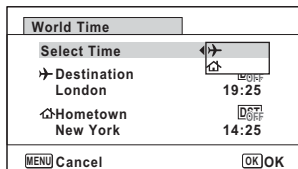

- Displays the time of the Destination city
- Displays the time of the Hometown city





7 Press the OK button.

The setting is saved.

8 Press the MENU button twice.

The camera returns to  mode or  mode.

When  (Destination) is selected in step 6, the  icon appears on the display to indicate that the destination date and time are displayed in  mode.





Setting the Text Size on the Menu

You can set the text size of the item selected with the cursor on the menu to [Standard] (normal display) or [Large] (magnified display).

1 Press the MENU button in mode.

The [ Setting] menu appears.

When you press the **MENU** button in  mode, press the four-way controller () once.

2 Use the four-way controller () to select [Text Size].

3 Press the four-way controller () .

A pull-down menu appears.

4 Use the four-way controller () to select the text size.

Select from [Standard] or [Large].

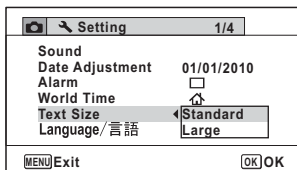

5 Press the OK button.

The setting is saved.



Changing the Display Language

You can change the language in which the menus, error messages, etc. are displayed.

The camera supports the following 20 languages: English, French, German, Spanish, Portuguese, Italian, Dutch, Japanese, Danish, Swedish, Finnish, Polish, Czech, Hungarian, Turkish, Greek, Russian, Thai, Korean, and Chinese (traditional and simplified).

1 Press the MENU button in mode.

The [ Setting] menu appears.

When you press the MENU button in  mode, press the four-way controller () once.



2 Use the four-way controller () to select [Language/言語].

3 Press the four-way controller () .

The [Language/言語] screen appears.

4 Use the four-way controller () to select the language.

Language/言語		
English	日本語	Türkçe
Français	Dansk	Ελληνικά
Deutsch	Svenska	Русский
Español	Suomi	ไทย
Portugués	Polski	한국어
Italiano	Čeština	中文繁體
Nederlands	Magyar	中文简体

 Cancel  OK

5 Press the OK button.

The menus and messages are displayed in the selected language.

Changing the System for Naming Folders

You can change the system for naming the folders for storing images. When the naming system is set to the date, pictures are saved in separate folders by the date they were taken.

Choice	The name of the folder
Date (Default)	xxx_mmdd (3-digit folder number_month day) * xxx_ddmm (3-digit folder number_day month) when the date format is set to [dd/mm/yy] A folder is made by day, and the images and sound files of the day are saved in the folder.
PENTX	xxxPENTX (xxx is the 3-digit folder number) Up to 9999 images are saved in the same folder.
_USER	xxxAAAAA (xxx is the automatically given 3-digit folder number, and AAAAA is the 5-digit letters that you entered) Up to 9999 images are saved in the same folder.

Image taken on April 1 with the folder name setting set to [Date] created.

A folder with the name "100_0401" is created.

The images are saved in the "100_0401" folder.

Image taken on April 8 with the folder name setting set to [Date] created.

A folder with the name "100_0408" is created.

The images are saved in the "100_0408" folder.

Image taken on April 10 with the folder name setting set to [PENTX] created.

A folder with the name "102PENTX" is created.

The images are saved in the "102PENTX" folder.

Image taken on April 15 with the folder name setting set to [PENTX] created.

A new folder is not created.

The images are saved in the "102PENTX" folder.

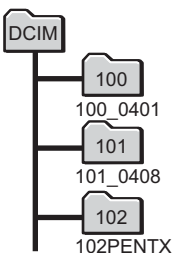
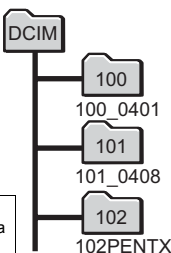
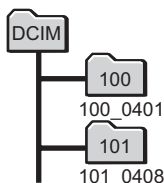
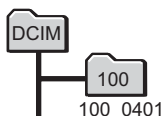

- Up to 900 folders can be created.
- Up to 9999 images or sounds can be saved in a folder.

Selecting a Rule for Naming Folders

1 Press the MENU button in mode.

The [Setting] menu appears.

When you press the MENU button in mode, press the four-way controller () once.

2 Use the four-way controller () to select [Folder Name].

3 Press the four-way controller ()

A pull-down menu appears.

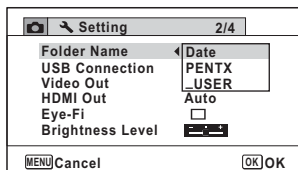

4 Use the four-way controller () to select the rule for naming folders.

5 Press the OK button.

The setting is saved.

Naming the Folder Yourself

You can name the folder in which to save images.

You can enter up to five numbers and letters.

The 5-digit name is displayed after the 3-digit folder number.

1 Select [_USER] in step 4 in “Selecting the Rule for Naming Folders”.

2 Press the four-way controller ()

The folder naming screen appears.
“_USER” has already been entered.

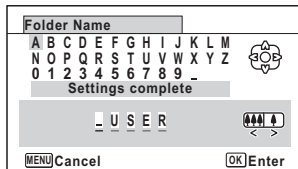

- 3** Use the four-way controller (▲▼◀▶) to select the letter to enter, and press the **OK** button.

The first letter is fixed and the cursor moves to the second letter.

- 4** Repeat step 3 and enter the remaining letters.

- 5** Press the four-way controller (◀) while “A” is selected, or press (▼▶) while “_” is selected.

The frame moves to [Settings complete].

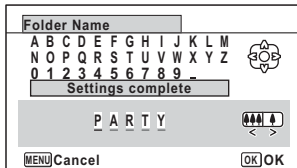

- 6** Press the **OK** button twice.

The folder name is fixed, and returns to the [Setting] menu.



- You can move the cursor by pressing the zoom button.
- The name of the folder that was set is displayed in the [Setting] menu.

Changing the Video Output Format

7

Settings

When you connect the camera to AV equipment, choose the appropriate video output format (NTSC or PAL) for taking and playing back images.

- 1** Press the **MENU** button in mode.

The [Setting] menu appears.

When you press the **MENU** button in mode, press the four-way controller (▶) once.

- 2** Use the four-way controller (▲▼) to select [Video Out].

- 3** Press the four-way controller (▶).

A pull-down menu appears.

4 Use the four-way controller (▲▼) to select a video output format.

Choose the video output format to match the output format of the AV equipment.

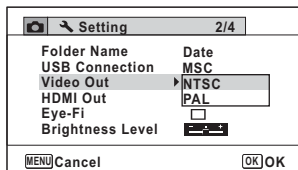

5 Press the OK button.

The setting is saved.



Depending on the country or region, images and sound files may fail to be played back if the video output format is set differently from the one in use there. If this happens, change the video output format setting.

Connecting the Camera to AV Equipment p.184
Video Output Format by City p.300

Selecting the HDMI Output Format

When you connect the camera to AV equipment with an HDMI cable, set the appropriate video output resolution for playing back images. The default setting is [Auto].

1 Press the MENU button in mode.

The [Setting] menu appears.

When you press the **MENU** button in mode, press the four-way controller (▶) once.

2 Use the four-way controller (▲▼) to select [HDMI Out].

3 Press the four-way controller (▶).

A pull-down menu appears.

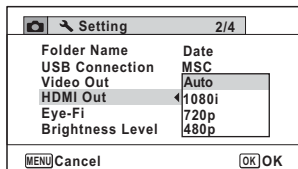

4 Use the four-way controller (▲▼) to select an output format.

Choose the HDMI output format to match the output format of the AV equipment.

5 Press the OK button.

The setting is saved.



The items on the pull-down menu vary depending on the selected Video output format.

To change the display, set the Video output format before setting the HDMI output format.

The table below shows the combinations of the Video output format and HDMI output.



	Video output format	
	NTSC	PAL
Resolution	Auto (The largest size that both the TV and camera support is automatically selected)	
	1080i (1920×1080i)	
	720p (1280×720p)	
	480p (1920×1080i)	576p (720×576p)

Setting the Eye-Fi Communication

You can automatically transfer images or movies to a computer or similar devices via wireless LAN using a commercially available Eye-Fi card. For details on transferring images, refer to “Transferring Images Using an Eye-Fi Card” (p.285). The default setting is (Off).

1 Press the **MENU** button in mode.

The [ Setting] menu appears.

When you press the **MENU** button in  mode, press the four-way controller () once.

2 Use the four-way controller () to select [Eye-Fi].

3 Use the four-way controller () to select or .

- Turns on communication using an Eye-Fi card
- Turns off communication using an Eye-Fi card

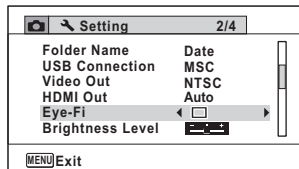

4 Press the **OK** button.

The setting is saved.





- To establish an Eye-Fi communication, you first have to specify a wireless LAN access point and transfer destination on the Eye-Fi card. For details on how to set up the card, refer to the operating manual supplied with the Eye-Fi card.
- The Eye-Fi setting returns to the default setting when the camera is turned off.

Adjusting the Brightness of the Display

You can adjust the brightness of the display to 7 levels.



1 Press the **MENU** button in mode.

The [ Setting] menu appears.

When you press the **MENU** button in  mode, press the four-way controller () once.

2 Use the four-way controller () to select [Brightness Level].

3 Use the four-way controller () to adjust the brightness.

-  Dark
-  Normal
-  Bright

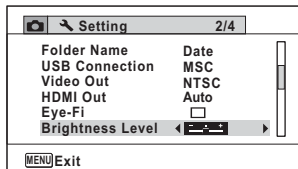

4 Press the **MENU** button.

The camera returns to  mode or  mode.



The display appears with the set brightness.

Using the Power Saving Function

You can save battery power by setting the display to dim automatically when no operation is performed for a fixed time. After the power saving function has been activated, the display returns to the ordinary brightness if any button is pressed.

1 Press the **MENU** button in mode.

The [ Setting] menu appears.

When you press the **MENU** button in  mode, press the four-way controller () once.

2 Use the four-way controller () to select [**Power Saving**].

3 Press the four-way controller () .

A pull-down menu appears.

4 Use the four-way controller () to select the time until the camera enters power saving mode.

Choose from [2min.], [1min.], [30sec.], [15sec.], [5sec.] or [Off].

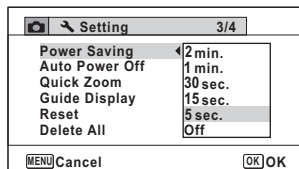

5 Press the **OK** button.

The setting is saved.





- Power Saving does not function in the following situations:
 - While taking pictures in the continuous shooting mode
 - In the playback mode
 - During movie recording
 - While the camera is connected to a computer
 - When using the AC adapter
 - While a menu is being displayed
 - In the  (Digital Microscope) mode
- When no operation is performed after the camera is turned on, Power Saving is activated only after 15 seconds elapse even if [5sec.] is set.

Setting Auto Power Off

You can set the camera to turn off automatically when no operation is performed for a fixed time.

1 Press the **MENU** button in mode.

The [ Setting] menu appears.

When you press the **MENU** button in  mode, press the four-way controller () once.

2 Use the four-way controller () to select [**Auto Power Off**].

3 Press the four-way controller ().

A pull-down menu appears.

4 Use the four-way controller () to select the time until the camera turns off automatically.

Choose from [5min.], [3min.] or [Off].

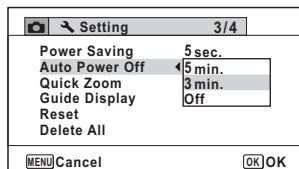

5 Press the **OK** button.



The setting is saved.



Auto Power Off does not function in the following situations:



- While taking pictures in the continuous shooting mode
- While recording a movie
- During a slideshow or movie/sound playback
- While the camera is connected to a computer
- While recording sound in Voice Recording mode
- While images are being transferred in Eye-Fi communication.

Setting the Quick Zoom Function

While playing back images in  mode, you can set whether to use Quick Zoom to enlarge the playback image to 10× when pressing the  button once.

1 Press the **MENU** button in mode.

The [ Setting] menu appears.

When you press the **MENU** button in  mode, press the four-way controller () once.

2 Use the four-way controller () to select [Quick Zoom].

3 Use the four-way controller () to switch between (On) or (Off).

- (On) The Quick Zoom is available.
- (Off) The Quick Zoom is not available.

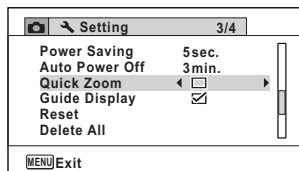

4 Press the **MENU** button.



The camera returns to  mode or  mode.

Setting the Guide Display

Set whether to display the guide for the Capture Mode Palette or Playback Mode Palette.

1 Press the **MENU** button in mode.

The [ Setting] menu appears.

When you press the **MENU** button in  mode, press the four-way controller () once.

2 Use the four-way controller () to select [Guide Display].

3 Use the four-way controller () to switch between (On) or (Off).

- (On) The mode guides are displayed.
- (Off) The mode guides are not displayed.

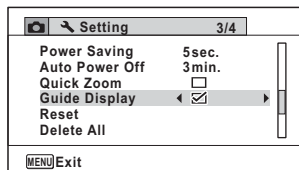

4 Press the **MENU** button.

The camera returns to  mode or  mode.

Perform Pixel Mapping

Pixel mapping is a function for mapping out and correcting for defective pixels in the CCD sensor. Run the Pixel Mapping function if image dots always seem to be defective in the same place.



- Pixel Mapping is only available in mode. Pixel mapping cannot be selected even if the [Setting] menu is displayed by pressing the **MENU** button in mode.
- When executing Pixel Mapping from mode, press the button once to enter mode. Then press the **MENU** button and the four-way controller () to display the [Setting] menu and select Pixel Mapping.
- Pixel Mapping cannot be selected in Voice Recording mode.

1 Press the **MENU** button in mode, and then press the four-way controller () once.

The [Setting] menu appears.

2 Use the four-way controller () to select [**Pixel Mapping**].

3 Press the four-way controller () .

The [Pixel Mapping] screen appears.

4 Use the four-way controller () to select [**Pixel Mapping**].

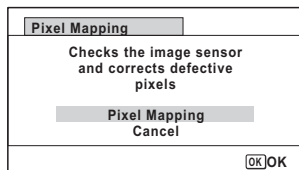

5 Press the **OK** button.

Defective pixels are mapped and corrected.



When the battery level is low, [Not enough battery power remaining to activate Pixel Mapping] is displayed on the monitor. Use the AC adapter kit K-AC88 (optional) or use a battery with ample capacity remaining.

Registering the Subscreen Image (Subscreen Input)

You can choose the subscreen image displayed on the upper-left corner of the display.

- One of the 3 pre-installed screens
- One of your own images (compatible images only)

1 In mode, press the four-way controller (▼).

The Playback Mode Palette appears.

2 Use the four-way controller (▲▼◀▶) to select (Subscreen Input).

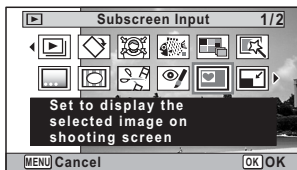

3 Press the OK button.

The image selection screen appears.

4 Use the four-way controller (◀▶) to choose the image for the subscreen.

Only images suitable for the subscreen are displayed. You can also choose one of the 3 pre-installed screens already stored in the camera.



5 Press the OK button.

The subscreen image is set.



Once the subscreen image has been set, it will not be deleted even if the original image is deleted or the SD Memory Card is formatted.

Changing the Start-up Screen

You can choose the start-up screen displayed when the camera is turned on. You can choose any of the following images as the start-up screen:

- The Guide Display Start-up Screen showing a guide to the shooting modes and buttons
- One of the 3 pre-installed screens
- One of your own images (compatible images only)

1 In mode, press the four-way controller (▼).

The Playback Mode Palette appears.

2 Use the four-way controller (▲▼◀▶) to select (Start-up Screen).



3 Press the OK button.

The image selection screen appears.

4 Use the four-way controller (◀▶) to choose the image for the start-up screen.

Only images suitable for the start-up screen are displayed. You can also choose one of the 3 pre-installed screens or the Guide Display Start-up Screen already stored in the camera.



5 Press the OK button.

The setting is saved.



- Once the start-up screen has been set, it will not be deleted even if the original image is deleted or the SD Memory Card is formatted.
- Select [Off] to hide the start-up screen.
- The start-up screen is not displayed when you turn the camera on in the playback mode.
- Movies or images taken at **■ ■ ■** (Digital Panorama) mode cannot be used for the start-up screen.

Resetting to Default Settings (Reset)

You can reset the camera settings to their defaults. Refer to “Default Settings” (p.295) for the reset settings.

1 Press the **MENU** button in **▶** mode.

The [Setting] menu appears.

When you press the **MENU** button in **▶** mode, press the four-way controller (**▶**) once.

2 Use the four-way controller (**▲ ▼**) to select [Reset].

3 Press the four-way controller (**▶**).

The [Reset] screen appears.

4 Use the four-way controller (**▲**) to select [Reset].

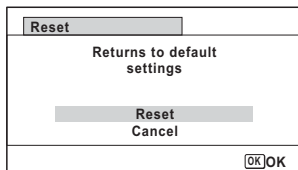

5 Press the **OK** button.

The settings return to the defaults.



The following settings are not affected by resetting:

- Date Adjustment
- World Time
- Language/言語
- Video Out
- The folder name that you created

Displaying the Clock Mode

You can use the camera as a clock. With the camera turned off, press and hold down the **OK** button to display the clock on the display.

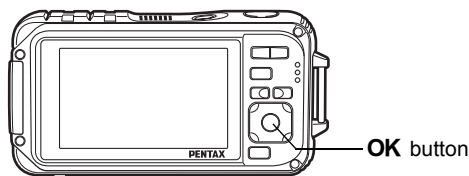

1 Press and hold down the **OK** button.

The camera turns on and the clock appears on the screen.

The camera turns off automatically after approximately 10 seconds.

Pressing the power switch turns the camera off immediately.



Memo

8 Connecting to a Computer

Setting Up Your Computer	262
Connecting to a Windows PC	269
Connecting to a Macintosh	279
Transferring Images Using an Eye-Fi Card	285

Setting Up Your Computer

By installing the software included on the provided CD-ROM on your computer and connecting the camera to your computer with the USB cable, you can transfer images and movies captured with your camera to the computer and then display and manage them. This section explains how to install the provided software and the other necessary preparations for enjoying the captured pictures and movies on your computer.

Provided Software

The following software is included in the provided CD-ROM (S-SW102).

- **Image viewing/managing/editing software “Medialmpression 2.0 for PENTAX”**
(12 languages: English, French, German, Spanish, Portuguese, Italian, Dutch, Swedish, Russian, Chinese [traditional and simplified], Korean, and Japanese)



It is recommended to use the optional AC adapter kit K-AC88 when the camera is connected to a computer (p.43). If the battery runs out of power while images are being transmitted to a computer, the data may be lost or damaged.

System Requirements

The following system requirements must be met for you to fully enjoy the images and movies captured with the camera on your computer.

Windows

OS	Windows XP SP2, Windows Vista or Windows 7 <ul style="list-style-type: none">The OS must be preinstalled and updated to the latest version.
CPU	Pentium 4 1.6 GHz or equivalent AMD Athlon (Intel Core 2 Duo 2.0 GHz or equivalent AMD Athlon X2 processor recommended)
Memory	512 MB minimum (1 GB or more recommended)
Hard Disk Space	300 MB minimum
Monitor	1024 × 768 pixels, 16-bit color monitor or higher
Others	CD-ROM drive USB port as standard equipment

- * Operation is not guaranteed on all computers meeting the system requirements.
- * The system requirements describe the minimum environment for playing movies.



Windows 95, Windows 98, Windows 98SE, Windows Me and Windows NT/Windows 2000 are not supported.

Macintosh

OS	Mac OS X (Ver.10.3.9, 10.4, 10.5, 10.6) <ul style="list-style-type: none">The OS must be preinstalled and updated to the latest version.
CPU	PowerPC G4 800 MHz processor (or equivalent to Power PC G5 with Intel Core Duo processor recommended)
Memory	512 MB minimum (1 GB or more recommended)
Hard Disk Space	300 MB minimum (1 GB or more recommended)
Monitor	1024 × 768 pixels, 16-bit color monitor or higher
Others	CD-ROM drive USB port as standard equipment

- * Operation is not guaranteed on all computers meeting the system requirements.
- * The system requirements describe the minimum environment for playing movies.

Installing the Software

Windows

Install the image viewing/managing/editing software (MediaImpression 2.0 for PENTAX).



- Make sure your Windows PC meets the system requirements before installing the software.
- When multiple accounts have been set up, log on with an account that has administrative rights before installing the software.

1 Turn your Windows PC on.

2 Insert the CD-ROM (S-SW102) into the CD-ROM drive.

The “MediaImpression 2.0 for PENTAX” installer screen appears.

If you are using Windows Vista

When the [AutoPlay] screen appears, display the language selection screen following the steps below.

- 1) Click [Run setup.exe].
- 2) Click [Allow].

If the installer screen does not appear

Display the installer screen following the steps below.

- 1) Double-click [My Computer] on the desktop.
- 2) Double-click the [CD-ROM drive (S-SW102)] icon.
- 3) Double-click the [Setup.exe] icon.

8

3 Click [ArcSoft].

The “Choose Setup Language” screen appears.



4 Choose a language, and click [OK].

The setup screen appears.
Follow the on-screen guidance to install the software.

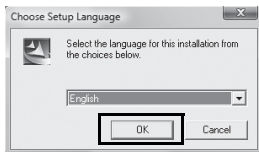

5 Click [Finish].

“MedialImpression 2.0 for PENTAX” installation is complete.

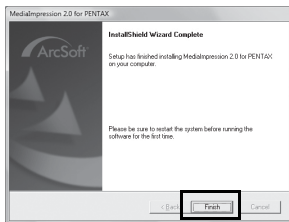

6 Click [Exit] on the installation screen.

The window closes.

Macintosh

Install the image viewing/managing/editing software (MedialImpression 2.0 for PENTAX).

1 Turn your Macintosh on.

2 Insert the CD-ROM (S-SW102) into the CD-ROM drive.

3 Double-click the CD-ROM (S-SW102) icon.

4 Double-click the [Pentax Software Installer] icon.

The “MedialImpression 2.0 for PENTAX” installer screen appears.

5 Click [ArcSoft].

The setup screen appears.
Follow the on-screen guidance to install the software.



6 Click [Close].

“Medialmpression 2.0 for PENTAX” installation is complete.

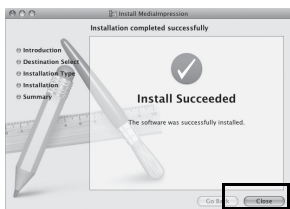

7 Click [Exit] on the installation screen.

The window closes.

Product Registration on the Internet

In order to better serve you, we request that you complete the product registration.

If your computer is connected to the Internet, please click [Product Registration] on the setup screen after the language selection screen is displayed.

The world map screen shown on the right for Internet Product Registration is displayed. Click the displayed country or region and then follow the instructions to register your product.

Only customers in countries and regions displayed on the software installation screen can register their products on the Internet Product Registration.

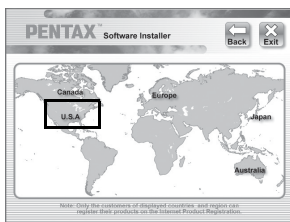

Setting the USB Connection Mode

Set the device to which the camera is connected with the USB cable.



Make sure to set the USB connection mode before connecting your camera to the computer. You cannot perform the following setting if the camera is already connected to your computer with the USB cable.

- 1 Turn your camera on.**
- 2 Press the MENU button in mode.**

The [Setting] menu appears.
When you press the MENU button in mode, press the four-way controller () once.
- 3 Use the four-way controller () to select [USB Connection].**
- 4 Press the four-way controller ().**

A pull-down menu appears.
- 5 Use the four-way controller () to select [MSC].**

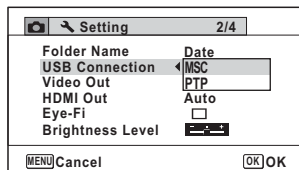

- 6 Press the OK button.**

The setting is saved.
- 7 Press the MENU button.**

The camera returns to mode or mode.

Proceed to the following pages depending on your computer.

Connecting to a Windows PC p.269

Connecting to a Macintosh p.279

MSC (Mass Storage Class)

A general-purpose driver program that handles devices connected to the computer via USB as a memory device. Also indicates a standard for controlling USB devices with this driver.

By simply connecting a device that supports USB Mass Storage Class, you can copy, read, and write files from a computer without installing a dedicated driver.

PTP (Picture Transfer Protocol)

A protocol that allows transfer of digital images and control of digital cameras via USB, standardized as ISO 15740.

You can transfer image data between devices that support PTP without installing a device driver.

Unless otherwise specified, select MSC when connecting the Optio W90 to your computer.

Connecting to a Windows PC

Connecting the Camera and Your Windows PC

Connect your camera to the Windows PC using the provided USB cable (I-USB7).

- 1 Turn your Windows PC on.**
- 2 Turn your camera off.**
- 3 Connect your camera to the Windows PC using the USB cable.**

Connect the terminal of the USB cable with arrow mark ← facing the front side of the camera.

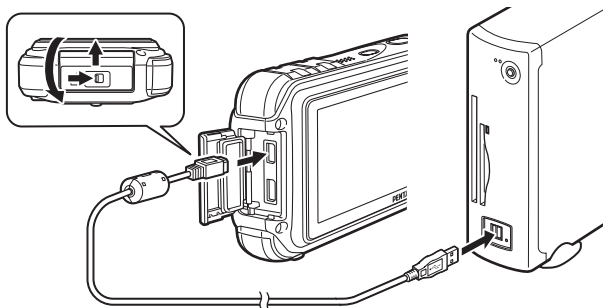

- 4 Turn your camera on.**

The “AutoPlay” screen appears.
If the “AutoPlay” screen does not appear, follow the steps in “When the “AutoPlay” Screen Does Not Appear” (p.271).



We recommend using the optional AC adapter kit K-AC88 when the camera is connected to the computer (p.43). If the battery runs out of power while images are being transmitted to the computer, the image data may be lost or damaged.



The power lamp is lit while the camera is connected to a PC, whereas it blinks while the card is being accessed.

Transferring Images

Transfer the images captured with the camera to your Windows PC.



If there is no SD Memory Card in the camera, the images stored in the built-in memory will be transferred to your Windows PC.

5 Click [Import media files to local disk].

The “MediImpression 2.0 for PENTAX” starts.



6 Set up [Destination Folder] and select [Subfolder Name].

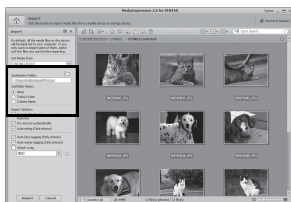

7 Select the image you want to copy, then click [Import].

The selected images are copied to the PC.

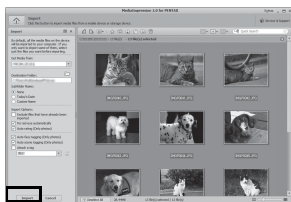

8 Click [Done].

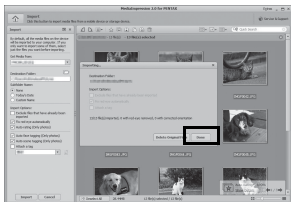

When the “AutoPlay” Screen Does Not Appear

5 Double-click the [MediaImpression 2.0 for PENTAX] icon on the desktop.



6 Click [Import].



7 Specify [Get Media From].

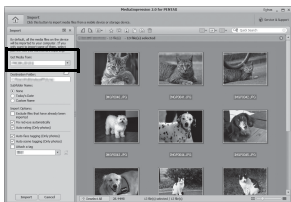

If the SD Memory Card has a volume label, the volume label name appears instead of [Removable Disk]. A new unformatted SD Memory Card may show the manufacturer's name or model number.

8 Set up [Destination Folder] and select [Subfolder Name].

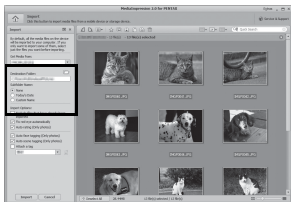

9 Select the image/s you want to copy, then click [Import].

The selected images are copied to the PC.

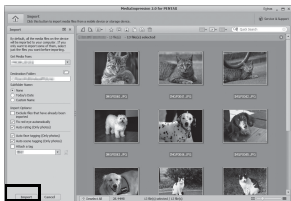

10 Click [Done].

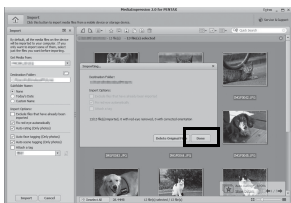

Images are stored in folders named by the shooting date (“XXX_0808” for August 8. “XXX” is a three-digit number.).

If [PENTX] is selected for [Folder Name] in the [Folder Setting] menu, a folder named “XXXPENTX” (XXX is a three-digit folder number) is displayed. If [USER] is selected for [Folder Name], “xxxAAAAA” (xxx is a three-digit folder number, AAAAA is the 5-digit letters that you entered) is displayed. The images are stored there.

Disconnecting the Camera from Your Windows PC

- 1 Double-click the  [Safely Remove Hardware] icon in the task bar.**



The “Safely Remove Hardware” screen appears.

- 2 Select [USB Mass Storage Device] and click [Stop].**

The “Stop a Hardware device” screen appears.

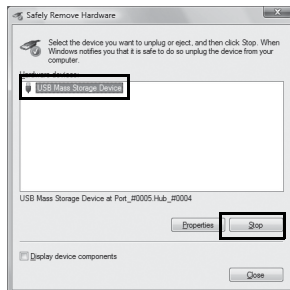

- 3 Select [USB Mass Storage Device] and click [OK].**

A message appears indicating that the hardware can be safely removed.

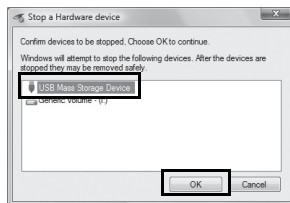

4 Click [OK], then click [Close].



5 Disconnect the USB cable from your Windows PC and the camera.



- If the camera (removable disk) is being used by an application such as “Medialmpression 2.0 for PENTAX”, the camera cannot be disconnected until the application is closed.
- The camera will automatically switch to the playback mode when the USB cable is disconnected from your Windows PC or the camera.

Starting “Medialmpression 2.0 for PENTAX”

“Medialmpression 2.0 for PENTAX” lets you view, edit, manage, search for, share, and print images.

1 Double-click the [Medialmpression 2.0 for PENTAX] icon on the desktop.

“Medialmpression 2.0 for PENTAX” starts and the main window appears.

Media Window Interface

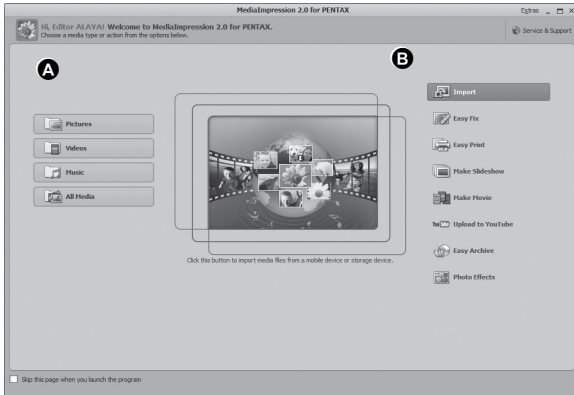

* The screen shown is an example with the default settings.

A Media browser tool

You can view images, movies, or play back audio files.

B Edit/Managing tool

You can edit or manage images. For example, you can import, edit or print images.



* The screen shown is an example with the default settings.

A Views

Displays the configuration of folders in your computer. When you browse a folder, the contents of the folder appear in the media thumbnail pane.

B Preview Area

Displays the contents of the selected folder or the results of the most recent search (the file or folder that matches the search item).

C Actions

This panel provides editing/managing functions, such as an importing, editing, movie making.

Viewing Images

- 1 Click [Pictures], [Videos], or [All Media] from the main window.

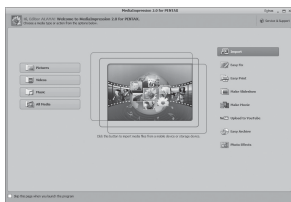

- 2 Select and click the folder containing the image you want to view in the folder pane.

Images are displayed in the media thumbnail pane.

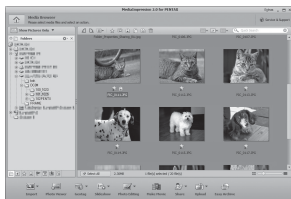

- 3 Select and double-click the image you want to view in the media thumbnail pane.

The selected image is displayed with the viewer.

With the viewer, you can enlarge/reduce the display size of the image or edit it and so on. You can also play back movies or sound files.



Photo Viewer

The image is displayed on the “Photo Viewer” screen if you double-click the image file directly without starting MediaImpression 2.0 for PENTAX. With the viewer, you can enlarge/reduce the display size of the image or edit it and so on. You can also play back movies or sound files.



Details on How to Use “MedialImpression 2.0 for PENTAX”

You can find more information on how to use “MedialImpression 2.0 for PENTAX” by using the help pages.

1 Click [Help] from [Extras] on the menu bar.

The help screen appears.

2 Click the desired topic.

An explanation is displayed.

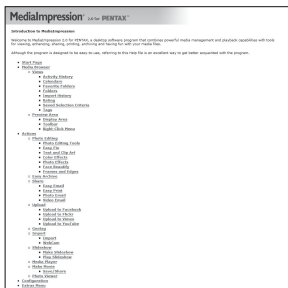

Connecting to a Macintosh

Connecting the Camera and Your Macintosh

Connect your camera to the Macintosh using the provided USB cable (I-USB7).

- 1 Turn your Macintosh on.**
- 2 Turn your camera off.**
- 3 Connect your camera to the Macintosh using the USB cable.**

Connect the terminal of the USB cable with arrow mark \leftarrow facing the front side of the camera.

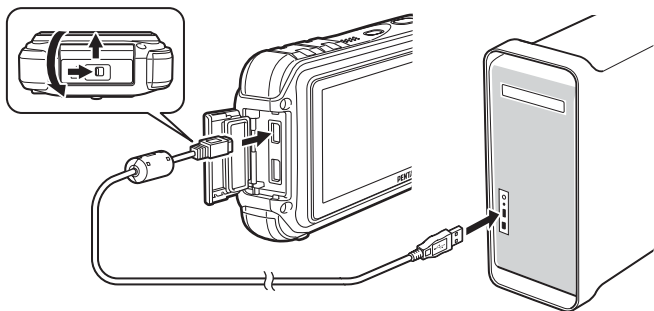

- 4 Turn your camera on.**
The camera is recognized as [NO_NAME] on the desktop.



We recommend using the optional AC adapter kit K-AC88 when the camera is connected to the computer (p.43). If the battery runs out of power while images are being transmitted to the computer, the image data may be lost or damaged.



- If the SD Memory Card has a volume label, the volume label name appears instead of [NO_NAME]. A new unformatted SD Memory Card may show the manufacturer's name or model number.
- The power lamp is lit while the camera is connected to a Macintosh, whereas it blinks while the card is being accessed.

Transferring Images

Transfer the images captured with the camera to your Macintosh.



If there is no SD Memory Card in the camera, the images stored in the built-in memory will be transferred to your Macintosh.

5 Double-click the [Medialimpression] folder inside the [Applications] folder.

6 Double-click the [Medialimpression 2.0 for PENTAX] icon.

“Medialimpression 2.0 for PENTAX” starts and the main browser window appears.

7 Set up [Destination Folder] and select [Subfolder Name].

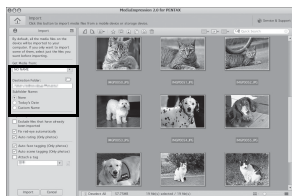

8 Select the image you want to copy, then click [Import].

The selected images are copied to the PC.

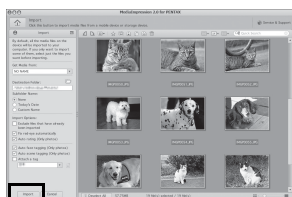

9 Click [Done].

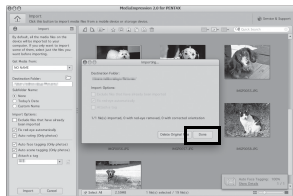

Disconnecting the Camera from Your Macintosh

1 Drag [NO_NAME] on the desktop to the trash.

If the SD Memory Card has a volume label, drag the icon of that name to the trash.

2 Disconnect the USB cable from your Macintosh and the camera.



- If the camera (removable disk) is being used by an application such as “Medialimpression 2.0 for PENTAX”, the camera cannot be disconnected until the application is closed.
- The camera will automatically switch to the playback mode when the USB cable is disconnected from your Macintosh or the camera.

Starting “Medialmpression 2.0 for PENTAX”

“Medialmpression 2.0 for PENTAX” lets you view, edit, manage, search for, share, and print images.

1 Double-click the [Medialmpression] folder inside the [Applications] folder.

2 Double-click the [Medialmpression 2.0 for PENTAX] icon.

“Medialmpression 2.0 for PENTAX” starts and the main browser window appears.

Media Window Interface

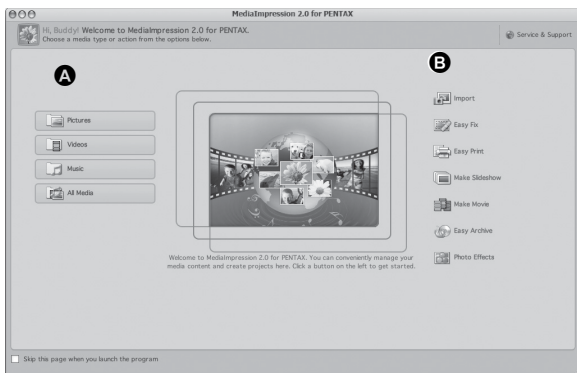

* The screen shown is an example with the default settings.

A Media browser tool

You can view images, movies, or play back audio files.

B Edit/Managing tool

You can edit or manage images. For example, you can import, edit or print images.

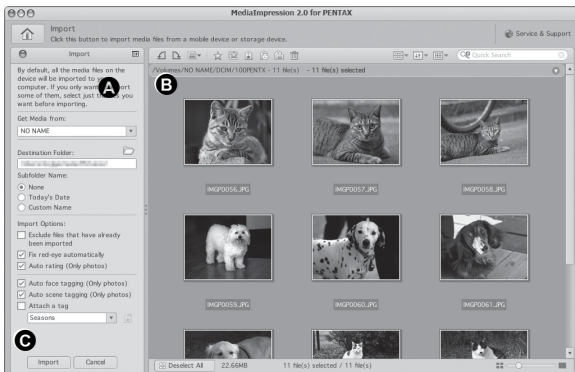

* The screen shown is an example with the default settings.

A Views

Displays the configuration of folders in your computer. When you browse a folder, the contents of the folder appear in the media thumbnail pane.

B Preview Area

Displays the contents of the selected folder or the results of the most recent search (the file or folder that matches the search item).

C Actions

This panel provides editing/managing functions, such as an importing, editing, movie making.

Viewing Images

- 1** Click **[Pictures]**, **[Videos]**, or **[All Media]** from the main window.
- 2** Select and click the folder containing the image you want to view in the folder pane.
Images are displayed in the media thumbnail pane.
- 3** Select and double-click the image you want to view in the media thumbnail pane.

The selected image is displayed with the viewer.

With the viewer, you can enlarge/ reduce the display size of the image or edit it and so on. You can also play back movies or sound files.



Details on How to Use “Medialmpression 2.0 for PENTAX”

You can find more information on how to use “Medialmpression 2.0 for PENTAX” by using the help pages.

- 1** Select **[Medialmpression]** from **[Help]** on the menu bar.
The help screen appears.
- 2** Click the desired topic.
An explanation is displayed.

Transferring Images Using an Eye-Fi Card

You can automatically transfer images or movies to a computer or similar devices via wireless LAN using a memory card that is equipped with the wireless LAN (Eye-Fi card) function.

1 Specify the wireless LAN access point and transfer destination on the Eye-Fi card.

For details on how to set up the card, refer to the operating manual supplied with the Eye-Fi card.

2 Turn the camera off.





3 Insert an Eye-Fi card that has been set up.

4 Turn the camera on.

5 Set [Eye-Fi] in the [⌘ Setting] menu to (On).

The images are transferred automatically. For details on how to set up the camera, refer to "Setting the Eye-Fi Communication" (p.249).

The following icons appear on the display.

Eye-Fi 	During Eye-Fi communication. The camera is communicating or searching for the access point when [Eye-Fi] is set to <input checked="" type="checkbox"/> (on).
Eye-Fi 	Eye-Fi communication waiting. The camera is not communicating when [Eye-Fi] is set to <input checked="" type="checkbox"/> (on).
Eye-Fi 	Eye-Fi communication prohibited. When [Eye-Fi] is set to <input type="checkbox"/> (off).
Eye-Fi 	Eye-Fi version error. The version of the Eye-Fi card is out of date or the card is write-protected.

Acceptable Eye-Fi cards

- Eye-Fi Share
- Eye-Fi Share Video 4 GB

Run the latest firmware on your Eye-Fi card.



- When you use a new Eye-Fi card, copy the install file of Eye-Fi Manager stored on the card to your computer before you format the card.
- Do not use an Eye-Fi card, or set [Eye-Fi] to (Off) in a location where wireless LAN devices are restricted or prohibited, such as on planes (since images are transferred via wireless LAN).
- If you insert an older version Eye-Fi card in the camera, an error message appears.
- Images are not transferred in the following cases:
 - When available wireless LAN access points are not found.
 - When the battery level is low ((yellow) or (red) is indicated).
- Voice recording sound files cannot be transferred.
- We recommend that you use an AC adapter (optional) when you transfer a large number of images because this often requires long transferring times.
- While images are being transferred, the Auto Power Off does not function.
- If you transfer large-sized files, such as a movie, the temperature inside the camera increases and the camera may be automatically turned off to protect the circuit.
- To transfer images via wireless LAN, use of an access point, an Internet environment, and configuration are required. For details, refer to the Internet website (<http://www.eye.fi>).
- For details on how to use an Eye-Fi card, refer to the operating manual supplied with the Eye-Fi card.
- If you have a problem with the Eye-Fi card, contact the manufacturer of the card.
- The camera is equipped with a function that sets Eye-Fi communication on or off, however, this does not guarantee availability of all the functions on the Eye-Fi card.
- Use of the Eye-Fi card is permitted only in the country where you purchased the card. Follow the laws of that country.

9 Appendix

Functions Available for Each Shooting Mode	288
Messages	291
Troubleshooting	293
Default Settings	295
List of World Time Cities	300
Optional Accessories	301
Main Specifications	302
Warranty Policy	307
Index	312

Functions Available for Each Shooting Mode

√: Can be set. ×: Cannot be set. —: Settings and changes are not applied.

Function		Shooting Mode										
		AUTO PICT	P	📷	📷	📷	📷	📷	📷	📷	📷	
Zoom button	Zoom operation	√*2	√*3	√*3	√*4	√*3	√*4	√*3	√*3	√*3	√*5	
📷 button	Face Detection On	√	√	√	√	√	√	√	√	√	×	
	Smile Capture	√	√	√	√	√	√	√	√	√	×	
	Face Detection Off	×	√	√	√	√	√	√	√	×	×*8	
Flash Mode	🔧 Auto	√	√	×	×	√	×	√	√	√	×	
	🔧 Flash Off	√	√	√	√	√	√	√	√	√	√	
	🔧 Flash On	√	√	√	×	√	×	√	√	√	×	
	🔧 Auto + Red-eye	√	√	×	×	√	×	√	√	√	×	
	🔧 Flash On + Red-eye	√	√	√	×	√	×	√	√	√	×	
	🔧 Soft Flash	√	√	√	×	√	×	√	√	√	×	
Drive Mode	📷 Standard	√	√	√	√	√	√	√	√	√	√	
	📷 Self-timer	√	√	√	√	√	√	√	√	√	√	
	📷 Continuous Shooting/ Burst Shooting	×	√	×	×	√	×	√	√	√	×	
	📷 Remote Control	√	√	√	√	√	√	√	√	√	√	
	📷 Interval Shoot	×	√	√	√	√	√	√	√	√	√	
	📷 Auto Bracket	×	√	√	×	√	×	√	√	√	×	
Focus Mode	AF Standard	√	√	√	√	√	√	√	√	√	×	
	🔍 Macro	√	√	√	√	√	√	√	√	√	×	
	🔍 1cm Macro	√	√	√	√	√	√	√	√	√	√	
	PF Pan Focus	√	√	√	√	√	√	√	√	√	×	
	▲ Infinity	√	√	√	√	√	√	√	√	√	×	
MF Manual Focus	√	√	√	√	√	√	√	√	√	×		
[📷 Rec. Mode] menu	Image Tone	×*9	√	√	√	×	×	×	×	×	√	
	Recorded Pixels	√*11	√*11	√*11	√*12	√*11	√*12	√*11	√*11	√*11	×*13	
	Quality Level	√	√	√	×	×	×	×	×	×	√	
	White Balance	×	√	√	√	×	×	×	×	×	√	
	AF Setting	Focusing Area	×	√	√	√*24	√	√*24	√	√	√	√
		Auto Macro	√	√	√	√	√	√	√	√	×	√
		Focus Assist	√	√	√	×	×	×	√	√	√	√
	AE Metering	×	√	√	×	×	×	×	×	×	√	
	Sensitivity	√	√	√	×	×	×	×	×	×	√	
	ISO Correction in AUTO	√	√	√	×	×	×	×	×	×	√	
	EV Compensation	×	√	√	√	√	√	√	√	√	√	
	D-Range Setting	×	√	√	√	√	√	√	√	√	√	
	Pixel Track SR*1	√	√	√	×	×	×	×	√	√	√	
	Blink Detection	√	√	√	×	×	×	×	√	√	×	
	Sharpness											
Saturation (Tone Adjustment)	×	√	√	√	×	×	×	×	×	√		
Contrast												
Date Imprint	√	√	√	×	×	×	×	√	√	√		
Macro Light	√	√	√	√	√	√	√	√	√	×		

Shooting Mode									Function		
									Zoom operation	Zoom button	
x	√ ⁶	√ ³	√ ⁶	√	√ ³	√ ³	√ ⁶	√ ⁷	Face Detection On	☺ button	
√	√	√	x	√	√	√	√	√	Smile Capture		
√	√	√	x	√	√	√	√	√	Face Detection Off		
√	√	√	√	x	√	√	√	√	⚡ Auto	Flash Mode	
√	√	√	√	√	√	√	√	√	🔋 Flash Off		
√	√	√	√	x	√	√	√	x	⚡ Flash On		
√	√	√	√	x	√	√	√	x	👁️ Auto + Red-eye		
√	√	√	√	x	√	√	√	x	👁️ Flash On + Red-eye		
√	√	√	√	x	√	√	√	x	SOFT Soft Flash		
√	√	√	√	√	√	√	√	√	☐ Standard	Drive Mode	
√	√	√	√	√	√	√	√	√	🕒 Self-timer		
x	√	√	√	x	x	x	√	x	📷 Continuous Shooting/ Burst Shooting		
√	√	√	√	√	√	√	√	x	📡 Remote Control	Focus Mode	
x	√	√	√	x	x	√	√	x	🕒 Interval Shoot		
x	√	√	√	x	x	x	√	x	📷 Auto Bracket		
√	√	√	√	x	√	√	√	√	AF Standard	Focus Mode	
√	√	√	√	x	√	√	√	√	🌸 Macro		
x	√	√	√	x	√	√	√	x	1cm Macro		
√	√	√	√	x	√	√	√	√	PF Pan Focus		
√	√	√	√	√	√	√	√	x	▲ Infinity		
√	√	√	x	√	√	√	√	x	MF Manual Focus	[📷 Rec. Mode] menu	
√	√	x ⁹	x ⁹	x ⁹	√	√	√	x ¹⁰	Image Tone		
x ¹⁴	x ¹⁵	√	√ ¹¹	√	√ ¹⁶	x ¹⁷	x ¹⁸	x ¹⁹	Recorded Pixels		
√	√	√	√	√	√	√	√	x ²¹	Quality Level		
√	√	x ²²	x ²²	x ²²	√	√	x ²²	x ²²	White Balance		
√	√	√	√	x ²³	√	√ ²⁴	√	x ²³	Focusing Area		AF Setting
√	√	√	√	x	√	√	√	x ²⁵	Auto Macro		
√	√	√	√	x	√	√	√	x ²⁵	Focus Assist		
√	√	x ²⁶	x ²⁶	x ²⁶	√	√	x ²⁶	x ²⁶	AE Metering		
√	x ²⁷	√	√	x ²⁸	√	√	√	x ²⁷	Sensitivity		
√	x ³⁰	√	√	x	√	√	x ³⁰	—	ISO Correction in AUTO		
√	√	√	√	√	√	√	√	x ³¹	EV Compensation		
√	√	√	√	√	√	√	√	x ⁸	D-Range Setting		
x ⁸	√	√	√	x ⁸	x ⁸	x ⁸	√	x ⁸	Pixel Track SR-1		
x ⁸	√	√	√	√	x ⁸	√	√	x ²⁵	Blink Detection		
√	√	x ³²	x ³²	x ³²	√	√	x ³²	x ³²	Sharpness		
√	√	√	√	√	√	√	√	√	Saturation (Tone Adjustment)		
√	√	√	√	√	√	√	√	√	Contrast		
√	√	√	√	√	√	√	√	x ⁸	Date Imprint		
√	√	√	√	√	√	√	√	x ⁸	Macro Light		

- *1 Movie SR is used for movies, while Pixel Track SR is used for still pictures.
- *2 Flowers cannot be detected when using Digital Zoom or Intelligent Zoom.
- *3 Optical zoom is always possible, digital zoom and intelligent zoom cannot be used if the Sensitivity selection is ISO 3200/6400.
- *4 Before shooting only optical zoom and digital zoom are possible, during shooting only digital zoom is possible.
- *5 Only optical zoom and intelligent zoom are possible, digital zoom cannot be used.
- *6 Only optical zoom is possible, digital zoom and intelligent zoom cannot be used.
- *7 Only optical zoom and digital zoom are possible, intelligent zoom cannot be used.
- *8 Fixed to (Off)
- *9 Fixed at Natural
- *10 Fixed at Bright
- *11 Fixed to **5M**/**3.8M** when the Sensitivity selection is ISO 3200/6400.
- *12 Set in [Movie] on the [Rec. mode] menu
- *13 Fixed to **2.1M**
- *14 Fixed to **3M** for individual pictures, and fixed to **5M** for composite images.
- *15 Fixed to **5M**/**3.8M** for individual pictures, and fixed to **5M** for composite 3 images.
- *17 Fixed to **3M**/**2.1M**
- *18 Fixed to **1280**
- *19 Fixed to **12M**
- *20 Fixed to **★★★** (Best) equivalent
- *21 Fixed to **★★** (Better)
- *22 Fixed to **AWB**
- *23 Fixed to (Multi)
- *24 (Automatic Tracking) is not available
- *25 Fixed to (On)
- *26 Fixed to (Multi-segment metering)
- *27 Fixed to AUTO
- *28 The sensitivity is fixed at its minimum setting
- *29 Fixed at 80-800
- *30 Fixed at 80-6400
- *31 Fixed at ± 0.0
- *32 Fixed as standard

Messages











Messages such as the following may appear on the display during camera operation.

Message	Description
Battery depleted	The battery is exhausted. Charge the battery using the battery charger (p.38).
Memory card full	The SD Memory Card is full and no more images can be saved.
The card memory is not enough to copy images/sounds	Insert a new SD Memory Card or delete unwanted images. (p.45, p.176) Change the recorded pixels or quality level of recorded images and try again (p.190).
Memory card error	Shooting and playback are impossible due to a problem with the SD Memory Card. You may be able to display or copy the images on the card using a computer.
The built-in memory is not formatted	The data within the built-in memory are damaged. Format the built-in memory.
Card is not formatted	The SD Memory Card you have inserted is unformatted or has been formatted on a computer or other device and is not compatible with this camera. Format the SD Memory Card in the camera (p.232).
Card is locked	The SD Memory Card is write-protected (p.47).
Compression error	This message occurs when the camera fails to compress an image. Change the quality level or recorded pixels of the image and try shooting or saving it again.
No image/sound	There are no image or sound files on the SD Memory Card or the built-in memory.
Movie recording stopped	This message appears when the internal temperature of the camera has exceeded normal operating limits while recording a movie.
Deleting	This message appears when deleting an image or sound file.
Camera cannot play this image and sound	You are trying to play back an image or sound in a format not supported by this camera. You may be able to play it back on another brand of camera or on your computer.
Image folder cannot be created	The largest file number (9999) has been assigned to an image in the largest folder number (999) and no more images can be saved. Insert a new SD Memory Card or format the card (p.232).
Protected	The image or sound file you are trying to delete is protected.

Message	Description
Data being recorded	Displayed when you try to switch to  mode while an image is still being recorded, or when the protect setting or DPOF setting is being changed. It disappears after the image is recorded or the setting is changed.
Data being processed	Displayed when the camera takes more than five seconds to display an image due to image processing, or when the SD Memory Card or the built-in memory is being formatted.
Built-in memory full	Displayed if the built-in memory is full when saving a file.
No image to be processed	Displayed when there are no images or sound files.
This image/sound cannot be processed	Displayed for files that cannot be processed.
No card in the camera	Displayed if no SD Memory Card is inserted when "Image/Sound Copy" is selected from the Playback Mode Palette and the OK button is pressed.
The built-in memory is not enough to copy images/sounds	Displayed when there is insufficient built-in memory to perform copying.
Cannot process correctly	Displayed when Red-eye Compensation processing fails.
Displays image/sound from built-in memory	Displayed when the camera enters the built-in memory display.
Not enough battery power remaining to activate Pixel Mapping	Displayed when the batteries are too low during Pixel Mapping. Change the batteries (p.39) or use the AC adapter kit K-AC88 (optional) (p.43).
No more images can be selected	Displayed when you select more than the maximum number of images.
The camera will turn off to prevent damage from overheating	Appears when the temperature inside the camera exceeds the highest limit.

Troubleshooting

Problem	Cause	Remedy
The camera will not turn on	The battery is not installed	Check if a battery is installed. If not, install a battery.
	The battery is installed incorrectly	Check orientation of the battery. Reinsert the battery according to the ⊕ ⊖ symbols in the battery compartment (p.39).
	The battery is exhausted	Charge the battery.
No image appears on the display	The camera is connected to a computer	The display is off when the camera is connected to a computer.
	The camera is connected to a TV	The display is off when the camera is connected to a TV.
	The display is set to off.	Press the OK/DISPLAY button to turn the display on.
The display is hard to see	The brightness level of the display is set too dark	Adjust the brightness level in [Brightness Level] in the [Setting] menu. (p.250)
	Power Saving function is on	When the Power Saving function is on, the display automatically darkens after a certain amount of time. Press a button to return to the normal brightness level. Select [Off] in [Power Saving] in the [Setting] menu to turn the Power Saving function off (p.251).
The shutter will not release	The flash is charging	Pictures cannot be taken while the flash is charging. Wait until charging is finished.
	There is no available space on the SD Memory Card or in the built-in memory	Insert an SD Memory Card with available space or delete unwanted images (p.45, 176).
	Recording	Wait until recording is finished.
The picture is dark when using the flash	The subject is too far away in a dark environment, such as a night scene	The picture becomes dark if the subject is too far away. Take pictures within the specified flash range.

Problem	Cause	Remedy
The subject is not in focus	The subject is difficult to focus on with autofocus	The camera may have difficulty in focusing on such subjects as: low contrast subjects (a white wall, a blue sky, etc.), dark subjects, finely-patterned objects, rapidly-moving objects. It is also difficult to get proper focus when shooting through a window or a net (p.76). Try shooting using the focus lock, or MF (Manual Focus) (p.120).
	The subject is not in the focusing area	Locate the desired subject in the focus frame (focusing area) in the center of the display. If it is difficult to do so, first lock the focus on the desired subject (focus lock), and then move the camera to recompose.
The flash does not discharge	The flash mode is set to  (Flash Off)	Set to  (Auto) or  (Flash On) (p.117).
	The Drive Mode is set to  ,  , or  ; the Focus Mode is set to  (Infinity); or the Shooting Mode is set to  ,  ,  , or  .	The flash does not discharge in these modes.



Very occasionally, static electricity may cause camera to malfunction. In this case, remove the battery and install it again. If the camera is then working properly, you can continue using the camera.

Default Settings

The table below lists the factory default settings.

The meaning of the indications for menu items with a default setting is explained below.





Last Memory Setting





- Yes : The current setting (last memory) is saved when the camera is turned off.
- No : The setting returns to the default setting when the camera is turned off.
- * : The setting depends on the [Memory] setting (p.158).
- : N/A

Reset Setting



- Yes : The setting returns to the default setting with the Reset function (p.258).
- No : The setting is saved even after reset.
- : N/A

● [📷 Rec. Mode] Menu Items

Item	Default Setting (Shooting mode: P)	Last Memory Setting	Reset Setting	Page	
Image Tone	Bright	Yes	Yes	p.124	
Recorded Pixels	 (4000×3000)	Yes	Yes	p.125	
Quality Level	★★ (Better)	Yes	Yes	p.127	
White Balance	AWB (Auto)	*	Yes	p.128	
AF Setting	Focusing Area	  (Multiple)	Yes	Yes	p.121
	Auto Macro	<input checked="" type="checkbox"/> (On)	Yes	Yes	p.122
	Focus Assist	<input checked="" type="checkbox"/> (On)	Yes	Yes	p.123
AE Metering	 (Multi-segment)	*	Yes	p.130	
Sensitivity	AUTO (80-800)	*	Yes	p.131	
ISO Corction in AUTO	80-800	*	Yes	p.132	
EV Compensation	±0.0	*	Yes	p.133	



Item		Default Setting (Shooting mode: P)	Last Memory Setting	Reset Setting	Page	
Movie	Recorded Pixels	<u>1280</u> (1280×720/30 fps)	Yes	Yes	p.152	
	Movie SR	<input checked="" type="checkbox"/> (On)	Yes	Yes	p.153	
	Interval Shoot	Interval	1 min.	Yes	Yes	p.154
		Total Time	10 min.	Yes	Yes	p.154
	Start Delay	In 0 hr. 0 min.	Yes	Yes	p.154	
D-Range Setting	Highlight Correction	<input type="checkbox"/> (Off)	Yes	Yes	p.134	
	Shadow Correction	<input type="checkbox"/> (Off)	Yes	Yes	p.134	
Pixel Track SR		<input type="checkbox"/> (Off)	Yes	Yes	p.135	
Interval Shoot	Interval	0 min. 10 sec.	Yes	Yes	p.136	
	Number of Shots	2	Yes	Yes	p.136	
	Start Delay	In 0 hr. 0 min.	Yes	Yes	p.136	
Blink Detection		<input checked="" type="checkbox"/> (On)	Yes	Yes	p.138	
Digital Zoom		<input checked="" type="checkbox"/> (On)	*	Yes	p.89	
Instant Review		<input checked="" type="checkbox"/> (On)	Yes	Yes	p.139	
Memory	Face Detection	<input type="checkbox"/> (Off)	Yes	Yes	p.158	
	Flash Mode	<input checked="" type="checkbox"/> (On)	Yes	Yes		
	Drive Mode	<input type="checkbox"/> (Off)	Yes	Yes		
	Focus Mode	<input type="checkbox"/> (Off)	Yes	Yes		
	Zoom Position	<input type="checkbox"/> (Off)	Yes	Yes		
	MF Position	<input type="checkbox"/> (Off)	Yes	Yes		
	White Balance	<input type="checkbox"/> (Off)	Yes	Yes		
	Sensitivity	<input type="checkbox"/> (Off)	Yes	Yes		
	EV Compensation	<input type="checkbox"/> (Off)	Yes	Yes		
	AE Metering	<input type="checkbox"/> (Off)	Yes	Yes		
	Digital Zoom	<input checked="" type="checkbox"/> (On)	Yes	Yes		
	DISPLAY	<input type="checkbox"/> (Off)	Yes	Yes		
File No.	<input checked="" type="checkbox"/> (On)	Yes	Yes			
Green Button		Green Mode	Yes	Yes	p.139	
Sharpness		 (Normal)	Yes	Yes	p.143	
Saturation		 (Normal)	Yes	Yes	p.144	
Tone Adjustment		 (B&W)	Yes	Yes	p.144	
Contrast		 (Normal)	Yes	Yes	p.145	
Date Imprint		<input type="checkbox"/> (Off)	Yes	Yes	p.145	
Macro Light		<input type="checkbox"/> (Off)	Yes	Yes	p.146	

● [ Setting] Menu Items

Item		Default Setting	Last Memory Setting	Reset Setting	Page
Sound	Operation Volume	3	Yes	Yes	p.233
	Playback Volume	3	Yes	Yes	
	Start-up Sound	1	Yes	Yes	
	Shutter Sound	1	Yes	Yes	
	Operation Sound	1	Yes	Yes	
	Self-timer Sound	1	Yes	Yes	
Date Adjustment	Date Format (Date)	According to initial setting	Yes	No	p.55 p.235
	Date Format (time)	24h	Yes	No	
	Date	1/1/2010	Yes	No	
	Time	According to initial setting	Yes	No	
Alarm	Alarm	<input type="checkbox"/> (Off)	Yes	Yes	p.237
	Time	0:00	Yes	Yes	
World Time	Select Time	Same as  Hometown	Yes	Yes	p.239
	Destination (City)	According to initial setting	Yes	No	
	Destination (DST)	<input type="checkbox"/> (Off)	Yes	No	
	Hometown (City)	According to initial setting	Yes	No	
	Hometown (DST)	<input type="checkbox"/> (Off)	Yes	No	
Text Size		Standard	Yes	No	p.242
Language/ 言語		According to initial setting	Yes	No	p.51 p.243
Folder Name		Date	Yes	Yes*	p.244
USB Connection		MSC	Yes	Yes	p.267
Video Out		According to initial setting	Yes	No	p.246
HDMI Out		Auto	Yes	Yes	p.247
Eye-Fi		<input type="checkbox"/> (Off)	No	Yes	p.249
Brightness Level			Yes	Yes	p.250
Power Saving		5 sec.	Yes	Yes	p.251
Auto Power Off		3 min.	Yes	Yes	p.252
Quick Zoom		<input type="checkbox"/> (Off)	Yes	Yes	p.253
Guide Display		<input checked="" type="checkbox"/> (On)	Yes	Yes	p.254
Reset		Cancel	—	—	p.258
Delete All		Cancel	—	—	p.179
Pixel Mapping		Cancel	—	—	p.255
Format		Cancel	—	—	p.232

* Except the folder name that you created

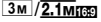
● Playback Mode Palette Items

Item		Default Setting	Last Memory Setting	Reset Setting	Page
Slideshow	Interval	3 sec.	Yes	Yes	p.169
	Screen Effect	Wipe	Yes	Yes	
	Sound Effect	On	Yes	Yes	
Image Rotation		Normal	—	—	p.172
Small Face Filter		Approx. 7%	No	No	p.192
Ink Rubbing Filter		3	No	No	p.199
Collage	Recorded Pixels		Yes	Yes	p.200
	Layout		Yes	Yes	
	Background	White	Yes	Yes	
	Select image(s)	—	—	—	
Digital Filter		B&W	No	—	p.194
Original Frame	Blur	All sides/White	No	—	p.209
	Edge Composite	All sides/White	No	—	
Frame Composite		Default1	Yes	Yes	p.206
Movie Edit	Save as Still Image	—	—	—	p.214
	Divide Movies	—	—	—	
	Adding title picture	—	—	—	
Red-eye Compensation		—	—	—	p.205
Subscreen Input		Default start-up screen 1	—	—	p.256
Resize	Recorded Pixels	Depending on the picture taken	—	—	p.190
	Quality Level	Depending on the picture taken	—	—	p.190
Cropping		Depending on the picture taken	—	—	p.191
Image/Sound Copy		Built-in memory → SD Memory Card	—	—	p.217
Voice Memo		—	—	—	p.228
Protect	Single Image/Sound	Depending on the recorded image/sound	—	—	p.181
	All Images/Sounds	Depending on the recorded image/sound	—	—	
DPOF	Single Image	Copies: 0	—	—	p.219
	All Images	Date: Off	—	—	
Image Recovery		Cancel	—	—	p.180
Start-up Screen		<input checked="" type="checkbox"/> (On)	Yes	Yes	p.257

● Key Operation

Item	Function	Default Setting	Last Memory Setting	Reset Setting	Page
button	Operation Mode	Mode	—	—	—
button	Zoom Position	Full wide-angle	*	No	p.87
Four-way controller	Drive Mode	<input type="checkbox"/> (Standard)	*	Yes	p.103- p.110
	Shooting Mode	(Auto Picture)	Yes	Yes	p.78
	Flash Mode	(Auto)	*	Yes	p.117
	Focus Mode	AF (Standard)	*	Yes	p.119
MENU button	Menu Display	Shooting mode: [Rec. Mode] menu Playback mode: [Setting] menu	—	—	p.65
OK/DISPLAY button	Information Display	Standard	*	Yes	p.24
button	Operation Mode	Face Detection On	*	Yes	p.81
Green Button	Function Recall	Green Mode	Yes	Yes	p.86

List of World Time Cities

City: indicates cities that can be set as either the Initial Setting (p.51) or the World Time (p.239).

Video Output Format: indicates the video output format of the city set as the Initial Setting.

Region	City name	Video output format	Region	City name	Video output format
North America	Honolulu	NTSC	Africa/West Asia	Istanbul	PAL
	Anchorage	NTSC		Cairo	PAL
	Vancouver	NTSC		Jerusalem	PAL
	San Francisco	NTSC		Nairobi	PAL
	Los Angeles	NTSC		Jeddah	PAL
	Calgary	NTSC		Tehran	PAL
	Denver	NTSC		Dubai	PAL
	Chicago	NTSC		Karachi	PAL
	Miami	NTSC		Kabul	PAL
	Toronto	NTSC		Male	PAL
	New York	NTSC		Delhi	PAL
	Halifax	NTSC		Colombo	PAL
Central and South America	Mexico City	NTSC	Kathmandu	PAL	
	Lima	NTSC	Dacca	PAL	
	Santiago	NTSC	East Asia	Yangon	NTSC
	Caracas	NTSC		Bangkok	PAL
	Buenos Aires	PAL		Kuala Lumpur	PAL
	Sao Paulo	PAL		Vientiane	PAL
Rio de Janeiro	NTSC	Singapore		PAL	
Europe	Lisbon	PAL		Phnom Penh	PAL
	Madrid	PAL		Ho Chi Minh	PAL
	London	PAL		Jakarta	PAL
	Paris	PAL		Hong Kong	PAL
	Amsterdam	PAL		Beijing	PAL
	Milan	PAL		Shanghai	PAL
	Rome	PAL		Manila	NTSC
	Copenhagen	PAL	Taipei	NTSC	
	Berlin	PAL	Seoul	NTSC	
	Prague	PAL	Tokyo	NTSC	
	Stockholm	PAL	Guam	NTSC	
	Budapest	PAL	Oceania	Perth	PAL
	Warsaw	PAL		Adelaide	PAL
	Athens	PAL		Sydney	PAL
	Helsinki	PAL		Noumea	PAL
Moscow	PAL	Wellington		PAL	
Africa/West Asia	Dakar	PAL		Auckland	PAL
	Algiers	PAL	Pago Pago	NTSC	
	Johannesburg	PAL			

Optional Accessories

A number of dedicated accessories are available for this camera. Products marked with an asterisk (*) are the same as those supplied with the camera.

- **Power supply**

- Rechargeable lithium-ion battery D-LI88 (*)**

- Battery charger kit K-BC88 (*)**

- (Battery charger D-BC88, AC plug cord)

- AC adapter kit K-AC88**

- (AC adapter D-AC64, DC coupler D-DC88, AC plug cord)

- The battery charger and AC adapter are only sold as a set.

- **Cable**

- USB cable I-USB7 (*)**

- AV cable I-AVC7 (*)**

- **Strap**

- O-ST103 (*)**

- O-ST104 (*)**

- O-ST24** Genuine leather strap.

- O-ST8** Silver chain strap.

- O-ST81** Waterproof strap.

- **Camera case**

- O-CC103**

- **Optio W90 Skin**

- O-CC1032** This cover protects the camera from scratches and light impacts.

- **Remote Control**

- REMOTE CONTROL WATERPROOF O-RC1**

- REMOTE CONTROL E**

- REMOTE CONTROL F**

Main Specifications

Type	Fully automatic compact digital still camera with built-in zoom lens	
Number of effective pixels	Approx. 12.1 megapixels	
Image sensor	1/2.3 inch CCD	
Number of recorded pixels	Still	<p> 12M (4000×3000), 9M (4000×2256), 7M (3072×2304), 5.3M (3072×1728), 5M (2592×1944), 3.8M (2592×1464), 3M (2048×1536), 2.1M (16:9) (1920×1080), 1024 (1024×768), 640 (640×480) </p> <ul style="list-style-type: none"> * Fixed at 5M/3.8M in Digital SR mode. * Fixed at 3M/2.1M in Frame Composite mode. * Fixed at 5M in Digital Wide mode, however, the first frame uses 3M. * Fixed at 2M for one frame in Digital Panorama mode. * Fixed at 2.1M in Digital Microscope mode. * Fixed at 5M/3.8M when the sensitivity is set to 3200 or 6400. * Fixed at 5M/3.8M in Burst Shooting mode. * Fixed at 1280 (1280×960) in Report mode.
	Movie	<p> 1280 (1280×720/30 fps), 1280 (1280×720/15 fps) 640 (640×480/30 fps), 640 (640×480/15 fps) 320 (320×240/30 fps), 320 (320×240/15 fps) </p>
Sensitivity	AUTO, Manual (ISO 80-6400) * The sensitivity is fixed at AUTO (80-6400) in Digital SR mode.	
File format	Still	JPEG (Exif 2.2), DCF 2.0, DPOF, PRINT Image Matching III
	Movie	AVI (Motion JPEG), approx. 30 fps/15 fps, PCM system, monaural sound, Movie SR (Movie Shake Reduction)
	Sound	Voice memo, voice recording: WAVE (PCM) system, monaural
Quality level	Still	★★★ "Best", ★★ "Better", ★ "Good"
	Movie	Fixed at ★★★ (Best) *Unchangeable
Storage media	Built-in memory (approx. 26.7 MB), SD Memory Card, SDHC Memory Card	

Approximate Image Storage Capacity and Recording Time
Still

	Built-in Memory			512 MB SD Memory Card		
	★★★	★★	★	★★★	★★	★
12M (4000×3000)	6 pictures	11 pictures	18 pictures	107 pictures	209 pictures	321 pictures
9M (4000×2256)	7 pictures	14 pictures	20 pictures	126 pictures	253 pictures	368 pictures
7M (3072×2304)	9 pictures	16 pictures	22 pictures	160 pictures	299 pictures	397 pictures
5.3M (3072×1728)	10 pictures	20 pictures	30 pictures	192 pictures	368 pictures	530 pictures
5M (2592×1944)	10 pictures	20 pictures	30 pictures	192 pictures	368 pictures	530 pictures
3.8M (2592×1464)	13 pictures	27 pictures	41 pictures	239 pictures	479 pictures	737 pictures
3M (2048×1536)	16 pictures	33 pictures	48 pictures	299 pictures	592 pictures	863 pictures
2.1M (1920×1080)	24 pictures	48 pictures	65 pictures	438 pictures	863 pictures	1162 pictures
1280 (1280×960)	38 pictures	71 pictures	100 pictures	686 pictures	1259 pictures	1777 pictures
1024 (1024×768)	59 pictures	100 pictures	131 pictures	1042 pictures	1777 pictures	2324 pictures
640 (640×480)	122 pictures	190 pictures	214 pictures	2158 pictures	3358 pictures	3777 pictures

- The image storage capacity is for reference only. The actual image storage capacity may vary depending on the SD Memory Card and the subject.
- **1280** (1280×960) can only be set for recorded pixels when  (Report) mode is set.

Movie/Sound

	Built-in Memory	512 MB SD Memory Card
1280 (1280×720/30 fps)	8 sec.	2 min. 30 sec.
1280 (1280×720/15 fps)	16 sec.	4 min. 53 sec.
640 (640×480/30 fps)	24 sec.	7 min. 11 sec.
640 (640×480/15 fps)	46 sec.	13 min. 36 sec.
320 (320×240/30 fps)	37 sec.	10 min. 56 sec.
320 (320×240/15 fps)	1 min. 8 sec.	20 min. 8 sec.
Sound	7 min. 17 sec.	2 hr. 8 min. 56 sec.

- The above figures are based on our standard shooting conditions and may vary depending on the subject, shooting conditions and type of the SD Memory Card used.
- Recording can continue until the built-in memory or the SD Memory Card is full, or the size of the recorded movie reaches 2 GB (when using an SDHC card). If recording stops at 2 GB, start recording again to continue to record the rest of the movie in blocks of 2 GB.

White balance	Auto, Daylight, Shade, Tungsten Light, Fluores. Light, Manual	
Lens	Focal Length	5.0 - 25.0 mm (approx. 28 mm - 140 mm in 35 mm equivalent focal length)
	Aperture	F3.5 (W) - F5.5 (T)
	Lens Composition	11 elements in 9 groups (5 aspherical elements)
	Zoom Type	Electrically driven
Optical zoom	5×	
Intelligent zoom	7M / 5.3M _{16:9} : approx. 6.5×, 5M / 3.8M _{16:9} : approx. 7.7×, 3M : approx. 9.8×, 2.1M _{16:9} : approx. 10.4×, 1024 : approx. 19.5×, 640 : approx. 31.3× (when combined with optical zoom)	
Digital zoom	Max. approx. 6.25× (combines with 5× optical zoom to give zoom magnification equivalent to 31.3×)	
Motion blur reduction	Still	Electronic shake reduction (Pixel Track SR), Hi-sensitivity shake reduction (Digital SR)
	Movie	Electronic movie shake reduction (Movie SR)
Display	2.7 inch wide-LCD, approx. 230,000 dots (AR coating (Cover Glass only))	
Playback modes	Single-frame, 6-frame, 12-frame, Enlargement (max. 10×, scrollable), Face Close-up Playback, Pet Close-up Playback, Folder Display, Calendar Display, Sound Playback, Histogram Display, Bright and Dark Area Compensation, Select & Delete, Slideshow, Resize, Cropping, Image/Sound Copy, Image Rotation, Digital Filter, Original Frame, Ink Rubbing Filter, Collage, Small Face Filter, Movie Playback/Edit (Save as Still image, Divide, Adding title picture), Frame Composite, Red-eye Compensation, Subscreen, Voice Memo, Protect, DPOF, Image Recovery, Start-up Screen	
Focus mode	Autofocus, Macro, 1cm Macro, Pan Focus, Infinity, Manual Focus	
Focus	Type	TTL contrast detection system by sensor Multiple (9-point autofocus)/spot/automatic tracking AF changeable
	Focus range (From lens face)	Standard : 0.5 m - ∞ (Full zoom range)
		Macro : 0.1 m - 0.6 m (Full zoom range)
		1cm Macro : 0.01 m - 0.3 m (At the intermediate position of the zoom range)
	* It is possible to switch to Infinity, Pan Focus and Manual Focus. * Face Detection AF is available only when the camera recognizes the subject's face.	
Focus Lock	By half-pressing the shutter release button	

Exposure control	AE Metering	Multi-segment metering, Center-weighted metering, Spot metering
		EV Compensation ± 2 EV (can be set in 1/3 EV steps)
Face detection	Detection of up to 32 people's faces (up to 31 face detection frames on the display), Smile Capture, Blink Detection * Face Detection AE is available only when the camera detects the subject's face.	
Pet detection	Registering: 3, Detecting: 1	
Shooting mode	Auto Picture, Program, Night Scene, Movie, Underwater, Underwater Movie, Landscape, Flower, Portrait, Digital Wide, Surf & Snow, Digital SR, Kids, Pet, Sport, Fireworks, Candlelight, Night Scene Portrait, Text, Food, Digital Panorama, Frame Composite, Report, Digital Microscope, Green, Voice Recording (can be used when Fn Setting assigned)	
Digital filter	B&W, Sepia, Toy Camera, Retro, Color (red, pink, purple, blue, green, yellow), Extract Color (red, green, blue), Color Emphasis (Sky Blue, Fresh Green, Delicate Pink, Autumn Leaves), High Contrast, Starburst (Cross, Heart, Star), Soft, Fish-eye, Brightness Filter	
Movie	Continuous Recording Time	Approx. 1 second - until built-in memory or SD Memory Card is full (however, maximum size is limited to 2 GB)
Shutter speed	1/1500 sec. - 1/4 sec., max. 4 sec. (Night Scene mode)	
Built-in flash	Modes	Auto, Flash Off, Flash On, Auto + Red-eye, Flash On + Red-eye, Soft Flash
	Flash Range	Wide-angle: approx. 0.3 m - 3.9 m (approx. 0.98 ft - 12.8 ft) (Sensitivity: in Auto condition) Telephoto: approx. 0.3 m - 2.5 m (approx. 0.98 ft - 8.2 ft) (Sensitivity: in Auto condition)
Drive mode	Single-frame, Self-timer (approx. 10 sec., approx. 2 sec.), Continuous Shooting, Burst Shooting, Remote Control (3-sec Remote Control, 0-sec Remote Control), Interval Shoot, Auto Bracket	
Self-timer	Electronic control type, control time: Approx. 10 sec., 2 sec.	
Time function	World Time	75 cities (28 time zones)
	Clock Mode	Clock display by holding down OK/DISPLAY button while camera is turned off (approx. 10 sec.)
	Alarm	Alarm with simultaneous display of the Clock mode at specified time
Power source	Rechargeable lithium-ion battery D-LI88, AC adapter kit (optional)	
Battery life	Image Storage Capacity	* Recording capacity shows approximate number of shots recorded during CIPA-compliant testing (with display on, flash used for 50% of the shots, and 23°C or 73.4°F). Actual performance may vary according to operating conditions.
	Approx. 205 pictures	
	Playback Time	* According to the results of in-house testing.
	Approx. 250 min.	
	Movie Recording Time	* According to the results of in-house testing.
	Approx. 85 min.	
	Sound Recording Time	* According to the results of in-house testing.
	Approx. 300 min.	

Interfaces	USB 2.0 (high-speed compatible) /PC/AV terminal / HDMI terminal (Type D (Micro))
Video output format	NTSC/PAL (monaural)
Waterproof and dustproof rating	JIS waterproof grade 8 and JIS dustproof grade 6 (IP68) Continuous underwater picture-taking possible for 2 hours at depth of 6 m.
Impact resistance rating	PENTAX drop test (1.2 m height onto a 5 cm thick plywood surface) complying with MIL-Standard 810F Method 516.5-Shock testing. * Waterproof performance is not guaranteed if the camera is exposed to impact such as being dropped or hit. * The camera is not guaranteed to be free of trouble or damages under every condition.
Dimensions	Approx. 107.5 (W) × 59.0 (H) × 25.0 (D) mm (excluding operating or protruding parts)
Weight	Approx. 144 g (excluding battery and SD Memory Card) Approx. 161 g (including battery and SD Memory Card)
Accessories	Rechargeable lithium-ion battery, battery charger, AC plug cord, USB cable, AV cable, software (CD-ROM), strap, Carabiner strap, Operating Manual, Quick Guide

Warranty Policy

All PENTAX cameras purchased through authorized bona fide photographic distribution channels are guaranteed against defects of material or workmanship for a period of twelve months from date of purchase. Service will be rendered, and defective parts will be replaced without cost to you within that period, provided the equipment does not show evidence of impact, sand or liquid damage, mishandling, tampering, battery or chemical corrosion, operation contrary to operating instructions, or modification by an unauthorized repair shop. The manufacturer or its authorized representatives shall not be liable for any repair or alterations except those made with its written consent and shall not be liable for damages from delay or loss of use or from other indirect or consequential damages of any kind, whether caused by defective material or workmanship or otherwise; and it is expressly agreed that the liability of the manufacturer or its representatives under all guarantees or warranties, whether expressed or implied, is strictly limited to the replacement of parts as hereinbefore provided. No refunds will be made on repairs by non-authorized PENTAX service facilities.

Procedure During 12-month Warranty Period

Any PENTAX which proves defective during the 12-month warranty period should be returned to the dealer from whom you purchased the equipment or to the manufacturer. If there is no representative of the manufacturer in your country, send the equipment to the manufacturer, with postage prepaid. In this case, it will take a considerable length of time before the equipment can be returned to you owing to the complicated customs procedures required. If the equipment is covered by warranty, repairs will be made and parts replaced free of charge, and the equipment will be returned to you upon completion of servicing. If the equipment is not covered by warranty, regular charges of the manufacturer or of its representatives will apply. Shipping charges are to be borne by the owner. If your PENTAX was purchased outside of the country where you wish to have it serviced during the warranty period, regular handling and servicing fees may be charged by the manufacturer's representatives in that country. Notwithstanding this, your PENTAX returned to the manufacturer will be serviced free of charge according to this procedure and warranty policy. In any case, however, shipping charges and customs clearance fees to be borne by the sender. To prove the date of your purchase when required, please keep the receipt or bills covering the purchase of your equipment for at least a year. Before sending your equipment for servicing, please make sure that you are sending it to the manufacturer's authorized representatives or their approved repair shops, unless you are sending it directly to the manufacturer. Always obtain a quotation for the service charge, and only after you accept the quoted service charge, instruct the service station to proceed with the servicing.

- This warranty policy does not affect the customer's statutory rights.
- The local warranty policies available from PENTAX distributors in some countries can supersede this warranty policy. Therefore, we recommend that you review the warranty card supplied with your product at the time of purchase, or contact the PENTAX distributor in your country for more information and to receive a copy of the warranty policy.



The CE Mark is a Directive conformity mark of the European Union.

For customers in USA

STATEMENT OF FCC COMPLIANCE

This device complies with Part 15 of the FCC Rules. Operation is subject to the following two conditions: (1) This device may not cause harmful interference, and (2) this device must accept any interference received, including interference that may cause undesired operation.

Changes or modifications not approved by the party responsible for compliance could void the user's authority to operate the equipment. This equipment has been tested and found to comply with the limits for a Class B digital device, pursuant to part 15 of the FCC Rules. These limits are designed to provide reasonable protection against harmful interference in a residential installation. This equipment generates, uses and can radiate radio frequency energy and, if not installed and used in accordance with the instructions, may cause harmful interference to radio communications. However, there is no guarantee that interference will not occur in a particular installation. If this equipment does cause harmful interference to radio or television reception, which can be determined by turning the equipment off and on, the user is encouraged to try to correct the interference by one or more of the following measures:

- Reorient or relocate the receiving antenna.
 - Increase the separation between the equipment and receiver.
 - Connect the equipment into an outlet on a circuit different from that to which the receiver is connected.
- * Consult the dealer or an experienced radio/TV technician for help.

For customers in Canada

This Class B digital apparatus complies with Canadian ICES-003.

Pour les utilisateurs au Canada

Cet appareil numérique de la classe B est conforme à la norme NMB-003 du Canada.

FOR CALIFORNIA, U.S.A. ONLY

Perchlorate Material-special handling may apply. The lithium battery used in this camera contains perchlorate material, which may require special handling. See www.dtsc.ca.gov/hazardouswaste/perchlorate

Declaration of Conformity

According to 47CFR, Parts 2 and 15 for
Class B Personal Computers and Peripherals

We: PENTAX Imaging Company
A Division of PENTAX of America, Inc.

Located at: 600 12th Street, Suite 300
Golden, Colorado 80401 U.S.A.
Phone: 303-799-8000 FAX: 303-790-1131

Declare under sole responsibility that the product identified herein complies with 47CFR Parts 2 and 15 of the FCC rules as a Class B digital device. Each product marketed is identical to the representative unit tested and found to be compliant with the standards. Records maintained continue to reflect the equipment being produced can be expected to be within the variation accepted, due to quantity production and testing on the statistical basis as required by 47CFR §2.909. Operation is subject to the following two conditions: (1) This device may not cause harmful interference, and (2) This device must accept any interference received, including interference that may cause undesired operation. The above named party is responsible for ensuring that the equipment complies with the standards of 47CFR §15.101 to §15.109.

Product Name: PENTAX Digital Still Camera

Model Number: Optio W90

Contact person: Customer Service Manager

Date and Place: February, 2010, Colorado

Information for Users on Collection and Disposal of Old Equipment and Used Batteries



1. In the European Union

These symbols on the products, packaging and/or accompanying documents mean that used electrical and electronic equipments and batteries should not be mixed with general household waste.

Used electrical/electronic equipments and batteries must be treated separately and in accordance with legislation that requires proper treatment, recovery and recycling of these products.

Following the implementation by member states, private households within the EU states may return their used electrical/electronic equipments and batteries to designated collection facilities free of charge*.

In some countries your local retailer may also take back your old product free of charge if you purchase a similar new one.

*Please contact your local authority for further details.



By disposing of this product correctly you will help ensure that the waste undergoes the necessary treatment, recovery and recycling and thus prevent potential negative effects on the environment and human health which could otherwise arise due to inappropriate waste handling.

2. In other countries outside the EU

These symbols are only valid in the European Union. If you wish to discard these items, please contact your local authorities or dealer and ask for the correct method of disposal.



Cd

For Switzerland: Used electrical/electronic equipment can be returned free of charge to the dealer, even when you don't purchase a new product. Further collection facilities are listed on the home page of www.swico.ch or www.sens.ch.

Note for the battery symbol (bottom two symbol examples): This symbol might be used in combination with a designation for the chemical element or compound in use. In this case you have to comply with the requirement set by the Directive for the chemicals involved.

Symbols

Mode	16, 64
button	61, 63
Mode	16, 64
button	60, 62
[Rec. Mode] Menu	69, 295
[Setting] Menu	71, 297
Green Mode	86
Delete	162, 176
/Q button	62
Q Magnify	173
Tele	87
3-sec Remote Control	106
0-sec Remote Control	106
Wide	87
/ button	60
Auto Picture	83
Night Scene	90
Night Scene Portrait	90
Movie	150
Surf & Snow	97
Sport	97
Digital SR	90
Kids	93
Pet	94
Program	85
Fireworks	90
Frame Composite	101
Text	98
Digital Wide	111
Digital Panorama	114
Landscape	79
Flower	79

Underwater	148
Underwater Movie	148
Food	79
Report	80
Digital Microscope	99

Numerics

1cm Macro	119
6-Image Display/	
12-Image Display	164

A

AC adapter	43
Adding sound (Voice Memo)	228
AE Metering	130
Alarm	237
Auto + Red-eye (Flash)	117
Auto Bracket	110
Auto Macro	122
Auto Picture Mode	83
Auto Power Off	252
Auto AWB (White Balance)	128
Auto (Flash)	117
Automatic Tracking AF	121
AV cable	185

B

B&W filter	194
Basic Mode	86
Battery Level Indicator	42
Blink Detection	77, 138
Brightness filter	194
Brightness Level	250
Built-in Memory	217
Built-in memory display	64

Burst Shooting 104

C

Calendar display 166

Camera shake 24, 89

Candlelight Mode 90

Capture Mode Palette 79

Changing volume 233

Charging a battery 38

Checking the

Memory Card 49

Clock Mode 259

Collage 200

Color emphasis filter 194

Color filter 194

Connecting the Camera to

AV Equipment 184

Connecting to a TV 184

Continuous Shooting 104

Contrast 145

Copy 217

Cropping 191

D

Date Adjustment 55, 235

Date Imprint 145

Daylight saving time 54

Default Settings 295

Delete all 179

Delete  162, 176

Deleting sounds 177

Digital Filter 194

Digital Microscope Mode ... 99

Digital SR Mode 90

Digital Wide Mode 111

Digital Zoom 89

Display brightness 250

Display Language 243

Dividing movies 215

DPOF settings 219

D-Range Setting 134

Drive Mode

..... 103, 104, 108, 110

E

EV Compensation 133

Extract color filter 194

Eye-Fi 249, 285

F

Face Close-up Playback .. 174

Face Detection 81

Filters 194

Fireworks Mode 90

Fish-eye filter 194

Flash Mode 117

Flash Off  (Flash) 117

Flash On  (Flash) 117

Flash On + Red-eye

 (Flash) 117

Flower 79

Focus Assist 123

Focus Mode 119

Focusing 119

Focusing Area 121

Folder display 165

Folder Name 244

Food 79

Format 232

Four-way controller 61, 63

Frame Composite ... 101, 206

Frame Rate 152

G

Green button 139

Green button  61, 63

Green Mode 86

Guide Display 33

H

HDMI 247

High contrast filter 194

Highlight Correction	134
Histogram	34
Hometown	54, 239

I

Image Recovery	180
Image Rotation	172
Image Storage Capacity ..	303
Image Tone	124
Image/Sound Copy	217
Infinity ▲	119
Initial Setting	51
Ink Rubbing Filter	199
Installing a battery	39
Installing the software	264
Instant Review	77, 139
Interval Movie Mode	154
Interval Shoot 	108, 136
ISO Correction in AUTO ..	132



K

Kids Mode	93
-----------------	----

L

Landscape	79
Language setting	51, 243

M

Macintosh	263
Macro 	119
Macro Light	146
Magnify 	173
Manual Focus MF	119
Manual  (White Balance)	129
Mass Storage Class	268
MediaImpression	262
Memory	158
MENU button	60, 62
Movie Edit	214

Movie SR (Movie Shake Reduction) Function	153
MSC	268
Multi-segment metering 	130

N





Night Scene Mode	90
Night Scene Portrait Mode	90
Number of pixels	125

O

OK/DISPLAY button ...	61, 63
Operating the Menus	65
Optional accessory	301
Original Frame	209

P

Pan Focus PF	119
Panoramic Pictures	114
Pet Mode	94
Photo processing lab	219
Picture Transfer Protocol	268
Pixel Mapping	255
Pixel Track SR	135
Playback	162, 163
Playback (sound)	226
Playback (Voice Memo) ...	229
Playback Mode Palette	168, 298
Playing back movies	163
Portrait Mode	91
Power Saving	251
Power switch	49, 60, 62
Press fully (shutter release button)	76
Press halfway (shutter release button)	76
Product registration	266

Program Mode	85	Shutter release button	60, 62, 76
Protect 	181	Slideshow	169
Provided software	262	Small Face Filter	192
PTP	268	Smile Capture	81
R		Soft filter	194
Rec. Mode Menu	69, 295	Soft Flash  (Flash)	117
Recorded Pixels	125, 152	Sound settings	233
Recording movies	150	Sound types	233
Recovering images	180	Specifications	302
Red-eye Compensation ...	205	Sport Mode	97
Red-eye reduction   (Flash)	117	Standard AF	119
Regarding Waterproof, Dustproof, and Shockproof Design	8	Starburst filter	194
Remote Control Unit	106	Starting-up in the Playback Mode	50
Report	80	Start-up screen	257
Reset	258	Strap	36
Resetting settings	258	Subscreen	256
Resize	190	Subscreen Input	256
Retro filter	194	Surf & Snow Mode	97
Rotating	172	System requirements	263
S		T	
Saturation	144	Taking pictures underwater	148
Saving as still picture (movie)	214	Text Mode	98
Saving pictures by date ...	244	Text Size	242
Saving settings	158	Title picture of movie	216
SD Memory Card	45	Tone Adjustment	144
Select Time	241	Toy camera filter	194
Self-timer 	103	U	
Sensitivity	131	Underwater Mode	148
Sepia filter	194	Underwater Movie Mode	148
Setting Menu	71, 297	USB Connection	267
Shadow Correction	134	V	
Sharpness	143	Video output format	246, 300
Shooting information	24	Voice Memo	228
Shooting Mode	78		

Voice Recording 224

W

Waterproof and Dustproof

..... 148

White Balance 128

Windows 263

World Time 239

Z

Zoom ▲ ▲▲ 87

Memo

HOYA CORPORATION

PENTAX Imaging Systems Division

2-35-7, Maeno-cho, Itabashi-ku, Tokyo 174-8639, JAPAN
(<http://www.pentax.jp>)

PENTAX Europe Imaging Systems S.A.S.

(European Headquarters)

112 Quai de Bezons, B.P. 204, 95106 Argenteuil
Cedex, FRANCE
(HQ - <http://www.pentaxeurope.com>)
(France - <http://www.pentax.fr>)

**PENTAX Imaging Systems
GmbH**

Julius-Vosseler-Strasse 104, 22527 Hamburg, GERMANY
(<http://www.pentax.de>)

**PENTAX Imaging Systems
Limited**

PENTAX House, Heron Drive, Langley, Slough, Berks
SL3 8PN, U.K.
(<http://www.pentax.co.uk>)

PENTAX Imaging Company

A Division of PENTAX of America, Inc.

(Headquarters)
600 12th Street, Suite 300 Golden, Colorado 80401, U.S.A.
(PENTAX Service Department)
250 North 54th Street Chandler, Arizona 85226, U.S.A.
(<http://www.pentaximaging.com>)

PENTAX Canada Inc.

1770 Argentia Road Mississauga, Ontario L5N 3S7,
CANADA (<http://www.pentax.ca>)

**PENTAX Trading
(SHANGHAI) Limited**

23D, Jun Yao International Plaza, 789 Zhaojiabang
Road, Xu Hui District, Shanghai, 200032 CHINA
(<http://www.pentax.com.cn>)

<http://www.pentax.jp/english>

- Specifications and external dimensions are subject to change without notice.