



Reverie 8Q Adjustable Foundation

Owner's Manual and Reference Guide





Reverie 8Q Adjustable Foundation

Table Of Contents

Safety Precautions.....	3
Parts List.....	8
Adjustable Foundation Assembly Instructions	9
Bluetooth Accessory Module User’s Guide.....	12
Wireless Remote Control.....	15
Remote Control Operation Guide.....	16
Replacement Remote Control Programming.....	18
Remote Stand User’s Guide.....	21
Troubleshooting.....	22
Warranty.....	23

Warranty Information: *Please see the warranty that came with your product.*

Reverie 8Q Adjustable Foundation



CUSTOMER SERVICE: 800-973-8374

SAFETY PRECAUTIONS

**WARNING! IMPORTANT SAFETY INSTRUCTIONS.
PLEASE READ THESE INSTRUCTIONS
THOROUGHLY BEFORE USING THIS PRODUCT.
SAVE THESE INSTRUCTIONS!**

When using an electrical furnishing basic precautions should always be followed, including the following:

READ ALL INSTRUCTIONS BEFORE USING (THIS FURNISHING)

DANGER: To reduce the risk of electric shock:
Always unplug this furnishing from the electrical outlet before cleaning.

WARNING:

To reduce the risk of burns, fire, electric shock, or injury to persons:

- Unplug from outlet before putting on or taking off parts.
- Close supervision is necessary when this furnishing is used by or near children, invalids or disabled persons.
- Use this furnishing only for its intended use as described in these instructions.
Do not use attachments not recommended by the manufacturer.
- Never operate this furnishing if it has a damaged cord or plug, or if it is not working properly, dropped or damaged, or dropped into the water. Return the furnishing to a service center for examination and repair.
- Keep the cord away from heated surfaces.
- Never operate the furnishing with the air openings blocked. Keep the air openings free of lint, hair and the like.
- Never drop or insert any object into any opening.
- Do not use outdoors.
- Do not operate where aerosol (spray) products are being used or where oxygen is being administered.
- To disconnect, turn all controls to the off position, then remove plug from outlet.

CUSTOMER SERVICE: 800-973-8374

WARNING: Risk of Injury:

Keep children away from extended foot support (or other similar parts).

WARNING: Risk of electric shock:

Connect this furnishing to a properly grounded outlet only.
See Grounding instructions.

GROUNDING INSTRUCTIONS:

This product must be grounded. If it should malfunction or breakdown, grounding provides a path of least resistance for electric current to reduce the risk of electric shock. This product is equipped with a cord having an equipment-grounding conductor and a grounding plug. The plug must be plugged into an appropriate outlet that is properly installed and grounded in accordance with all local codes and ordinances.

DANGER:

Improper connection of the equipment-grounding conductor can result in a risk of electric shock. Check with a qualified electrician or serviceman if you are in doubt as to whether the product is properly grounded.

Do not modify the plug provided with the product. If it will not fit the outlet, have a proper outlet installed by a qualified electrician.

SAVE THESE INSTRUCTIONS!**L'AVERTISSEMENT:**

LE RISQUE DE CHOC ÉLECTRIQUE

L'AVERTISSEMENT:

N'UTILISE PAS PRÈS DE L'UTILISATION DE GENS OU DU PORTAGE DES ARTIFICES MÉDICAUX

POUR L'UTILISATION DU MÉNAGE/RÉSIDENTIELLE SEULEMENT

N'UTILISEZ PAS DEHORS

CUSTOMER SERVICE: 800-973-8374

This product is for use on a standard 120-volt circuit, and has a grounding plug that looks like the plug illustrated in photo A (see Figure). A temporary adapter that looks like the adapter illustrated in photo B and C able to be used to connect this plug to a 2-pole receptacle as shown in photo B if a properly grounded outlet is not available. The temporary adapter should be used only until a properly grounded outlet (photo A) can be installed by a qualified electrician. The green colored rigid ear, lug or the like extending from the adapter must be connected to a permanent ground such as a properly grounded outlet box cover. Whenever the adapter is used, it must be held in place by a metal screw.

This product is for use on a circuit having a standard rating of 120 volts and is factory equipped with a specific electric cord and plug to permit connection to a proper electric circuit. Make sure that the product is connected to an outlet having the same configuration as the plug. No adapter should be used with this product. If the product must be reconnected for use on a different type of electric circuit, the reconnection should be made by qualified service personnel.

Unauthorized modifications could void the electrical portion of your warranty. Failure to use a properly grounded outlet for this product or modification of the plug will compromise this important grounding safety feature and may result in electrical shock, electrical fire, or faulty operation of the product.

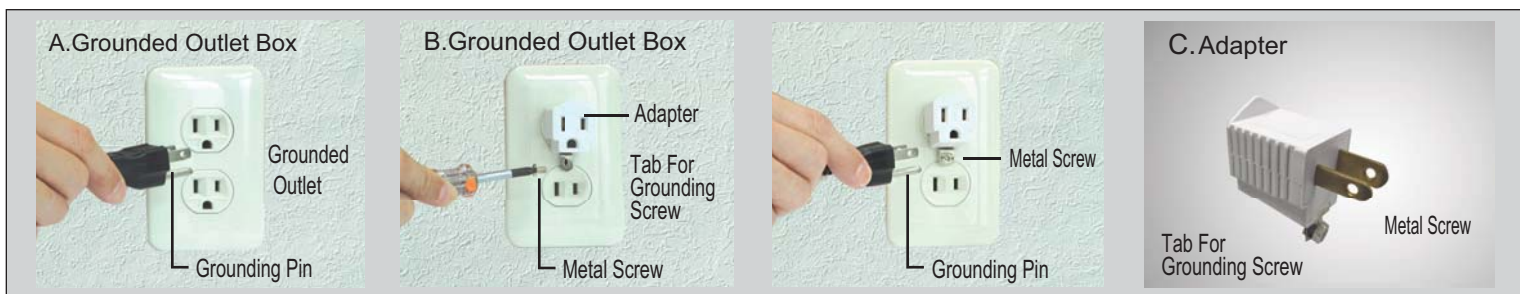

FOR BEST RESULTS, YOUR ADJUSTABLE FOUNDATION SHOULD BE PLUGGED INTO A SURGE PROTECTOR (not included).

WARRANTY PRECAUTION:

Do not open control box, motors or wireless remote controls (with the exception of the battery compartment if equipped). The warranty is void if these units are tampered with. Any repair or replacement of adjustable foundation parts must be performed by an authorized technician.

IN-HOME USE AND HOSPITAL DISCLAIMER:

Your adjustable foundation is strictly designed for in-home use only. It is NOT designed for hospital use and is NOT designed to meet hospital standards. Do not use this foundation with TENT TYPE oxygen therapy equipment or near explosive gases.

WARNING!

DO NOT USE NEAR PEOPLE USING OR WEARING MEDICAL DEVICES. FOR HOUSEHOLD / RESIDENTIAL USE ONLY. DO NOT USE OUTDOORS.

This product conforms to UL STD 962

CUSTOMER SERVICE: 800-973-8374

IMPORTANT SAFETY FEATURES:

Use this furnishing only for its intended use as described in these instructions. Do not use attachments not recommended by the manufacturer.

If there is an overload weight condition on the head or foot mechanism, the control unit will automatically stop all functions. Once the excess weight is removed the control unit will automatically allow all functions to resume operation after 30 seconds.

As with any product that produces a vibrating motion, it is possible that some pacemakers may interpret this motion as a false sense of movement and/or exercise. This may or may not affect your pacemaker. If you have any concerns, please consult your physician. For more information please contact customer service by calling **800-973-8374**.

USER-SERVICEABLE PARTS:

This product is specifically designed to have no maintenance by you, the user. Therefore, you are encouraged not to open any motors, alter the wiring, adjust, modify or change the structure of the product, as it will void the warranty.

POWER RATINGS:

INPUT: AC 120V - 60Hz, 1Amp

OUTPUT: DC 24V-3A

FUSE: 1.5A 250V

The input transformer voltage is AC120V (1.5 Amp) 60HZ, and the output voltage is DC24V (3Amp). When there is a short-circuit, a fuse on the transformer will be blown in order to protect the electrical equipment (Fuse: 1.5A). Should the above situation occur, the customer should seek professional assistance by calling a licensed electrician or by contacting customer service at **800-973-8374**.

SMALL CHILDREN AND PETS WARNING:

After your 8Q Adjustable Foundation has been unboxed, immediately dispose of packaging as it can smother small children and pets. To avoid injury, children and pets should not be allowed to play on or under the adjustable foundation.

Children should not operate this product without adult supervision. Close supervision is necessary when this furnishing is used by, or near children, invalids, or disabled persons.

SAVE THESE INSTRUCTIONS:

Your Reverie 8Q Adjustable Foundation has been designed to provide you with the reliable operation and durability you expect. This product has been inspected and tested prior to shipment.

CUSTOMER SERVICE: 800-973-8374

**RADIO FREQUENCY IS 433.92 MHZ
FCC COMPLIANCE**

This device complies with part 15 of the FCC Rules. Operation is subject to the following two conditions: (1) This device may not cause harmful interference, and (2) this device must accept any interference received, including interference that may cause undesired operation.

To comply with the FCC RF exposure compliance requirements, no change to the antenna or the device is permitted. Any change to the antenna or the device could result in the device exceeding the RF exposure requirements and void the user's authority to operate the device.

PRODUCT RATINGS

The lift motor in your **8Q** Adjustable Foundation is NOT designed for continuous use. Reliable operation and full life expectancy will be attained as long as the lift motor does not operate more than two (2) minutes over an eighteen (18) minute period, or approximately 10% duty cycle. Any attempt to circumvent or exceed this rating will shorten the life expectancy of this product and may void the warranty. The recommended weight restrictions for your **8Q** Adjustable Foundation is up to 850 lbs. total weight, including people and the mattress for all sizes of adjustable foundations. Lift speed will vary due to weight and mattress configuration, as well as the mattress type. The weight must be evenly distributed across the adjustable foundation.

This Product is not designed to support or lift 850 lbs of total weight in the head or foot sections of your **8Q** Adjustable Foundation alone, or in any unevenly distributed fashion. Some mattresses are not designed for Adjustable Foundations because they do not bend or flex well when adjusted. When using such a mattress with your **8Q** Adjustable Foundation the weight limits set forth herein do not apply, as the bending of the mattress requires significant force and puts significant strain on the motors and the Adjustable Foundation itself.

Note: Exceeding the recommended weight restrictions could damage your adjustable foundation and void your warranty and using a mattress on top of your adjustable foundation that is not designed for adjustability may also void your warranty.

For best performance, you should enter and exit the Adjustable Foundation while it is in the flat or fully lowered position.
DO NOT SIT ON THE HEAD OR FOOT SECTIONS WHILE IN THE RAISED POSITION.

INTENDED USAGE

The electric adjustable foundation should be installed with the head board brackets and/or the head of the frame positioned close to a wall.

CUSTOMER SERVICE: 800-973-8374



NOTE: Before discarding any packing materials, check the Adjustable Foundation frame carton and verify the following items in the parts list are included:

REVERIE 8Q ADJUSTABLE FOUNDATION
PARTS LIST

- A. Wireless Remote Control (1) and Three (3) AAA Batteries
- B. Mattress Retainer Bracket (4)
- C. Foundation Legs (4)
- D. Inner Headboard Bracket (2)
- E. Outer Headboard Bracket (2)
- F. Retainer Bar Bolt (8)
- G. Inner Headboard Bracket Bolt (4)
- H. Outer Headboard Bracket Bolt (4)
- I. Retainer Bar Plate (8)
- J. 5/16 Inch Washer (16)
- K. 5/16 Inch Locking Nut (8)
- L. Allen Key (1)
- M. Wrench (1)
- N. 9-Volt Batteries (2)



CUSTOMER SERVICE: 800-973-8374

IMPORTANT UNPACKING INSTRUCTIONS

To avoid damage to the adjustable foundation, always open the carton while the adjustable foundation is laying in the FLAT position on the floor.

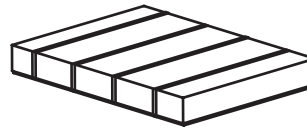

OPEN FLAT



STEP 1

Carefully lift the adjustable foundation unit out of the shipping carton, keeping the unit top side down. For safety reasons, this should be performed by 2 people.



STEP 2

Assembling adjustable foundation legs: Open the accessories box, take out the 4 legs, and thread them in a clockwise direction into the threaded holes in the frame.

NOTE: Tighten the legs securely to the frame. Leave no space between leg and frame.



Foundation overview

STEP 3

Remove and extend the power cord from the frame.

A 3-outlet, 2M, 13A UL approved power strip is pre-installed to the adjustable foundation to serve as power cord to the power outlet. One of the outlets is used to power the adjustable foundation. The remaining two outlets will be handy for the appliances near the foundations.

WARNING:
POWER CORDS MUST NOT INTERFERE WITH ANY ADJUSTABLE FOUNDATION MECHANISMS.

STEP 4

Remove the plastic packaging from the adjustable foundation.

CUSTOMER SERVICE: 800-973-8374

STEP 5

Carefully rotate the adjustable foundation over to the topside up position.

⚠ ATTENTION ! Improper handling

DO NOT

lean the adjustable foundation against the installed legs to flip it over.



STEP 6

Plug the power cord into a grounded electrical outlet.

NOTE: An Electrical surge protection unit is recommended (**not included**).

STEP 7

Install the batteries in your wireless remote control. Briefly activate all functions on the wireless remote control to verify that all of the features are operational. *If your **Reverie 8Q Adjustable Foundation** does **NOT** operate, please refer to the **Troubleshooting** section beginning on page 22 of this manual.*

STEP 8

Return the adjustable foundation to the flat position and proceed to assemble the **Mattress Retainer Brackets**.

STEP 9

NOTE: Use only a manual screwdriver to install the retainer bolts. **DO NOT** use a power screwdriver to tighten the bolts. **DO NOT** over tighten the mattress retainer hardware.

Use the Retainer Bolts (F) and Retainer Bar Plate (I) to fasten the Mattress Retainer Brackets (B) to the front of the adjustable foundation. (As shown in the diagram).



NOTE: If the adjustable foundation is to be set up without a headboard, simply install a mattress on the frame. Installation is now complete. If a headboard is to be installed, proceed to step 10.

ATTENTION: For any King / Split King configuration, do not add center retainer bars for either foundation on head or foot.

When two Twin XLS or two Split California Kings are put together, **DO NOT** install retainer bars in the center head or center foot section of the foundations.

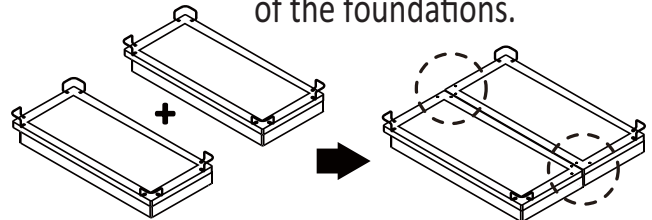

NOTE: It is important to position the bottom of the headboard cross member a maximum distance of 3 inches (76.2 mm) between the headboard and the top of the mattress. Do not exceed 3 inches (76.2 mm).

STEP 10

Install the headboard brackets to the adjustable foundation. Place one bracket on the left-hand side of the adjustable foundation and one bracket on the right-hand side of the adjustable foundation.

CUSTOMER SERVICE: 800-973-8374

Headboard Installation

1. Use the remote control to raise the head of the adjustable foundation in order to gain access to the foundation frame.
2. Remove plastic cap and place the Inner Headboard Bracket (D) into the round tube frame making sure the bracket inserted into the round tube.

This will create a box shape. Place the Headboard Bracket Bolt (G) with a 5/16 Inch Washer (J) through the pre-drilled hole in the round tube frame and pass it through the Inner Headboard Bracket. Use the 5/16 Inch Washer (J) and 5/16 Inch Locking Nut (K) and tighten the bolt in place. Repeat for the opposing side of the foundation frame.

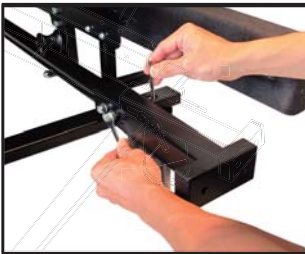

3. Place the open side of the outer headboard bracket (E) onto the exposed square tube of the inner head board bracket (D). This will create a tight fit between (D) and (E). Place a Headboard Bracket Bolt (G) with a 5/16 Inch Washer (J) through the Outer Headboard Bracket (E) and into the Inner Headboard Bracket (D). Use a 5/16 Inch Washer (J) and 5/16 Inch Locking Nut (K) and hand tighten to allow for adjustment. Repeat same procedure for opposing side of the adjustable foundation frame.



4. Firmly tighten the headboard bolts (not included) to the end of the headboard bracket assembly.
5. Measure the distance of the center to center mounting holes in the headboard.
6. Measure the distance of the center to center mounting holes in the headboard bracket assemblies.
7. If the headboard brackets require adjustments, loosen the bolts that are holding the outer headboard brackets and move them to the necessary distance. Reinstall the bolts and firmly tighten.

STEP 11

Place your mattress on top of your Adjustable Foundation.

Typical **Reverie 8Q** installation is now complete. If the adjustable foundation is equipped with a programmable setting or options, refer to the Remote Control Guide for more information.



Your **8Q** adjustable foundation has a Bluetooth Accessory Module as standard equipment.

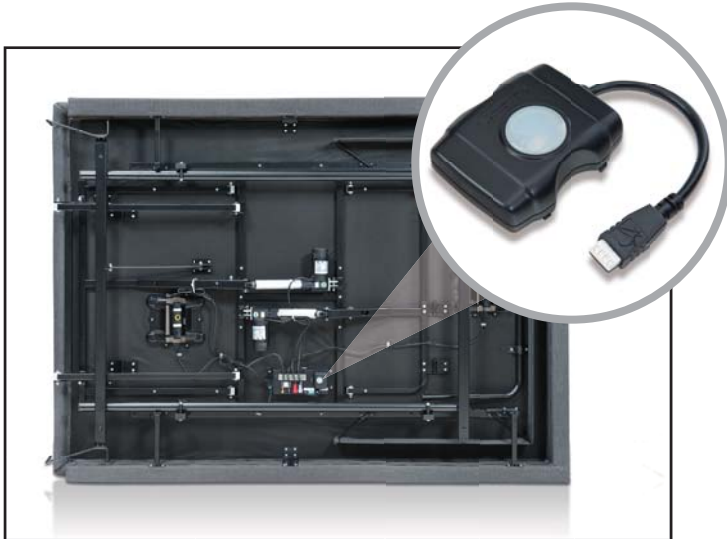

The Bluetooth Accessory Module allows you to control your adjustable foundation with your mobile device using a free, downloadable app. The Module is compatible with the following devices:

iPhone 4S or 5 series

iPad 3 or later

iPod Touch 5th generation

WiFi is not required for this device to operate.

Nightlight Feature

The LED light on the Bluetooth Accessory Module serves as a nightlight that can be controlled with the remote control or with your mobile device.



How to download the App Software

STEP 1

Please use your iPod Touch (5th generation), iPhone 4S or iPad 3 to log into the App store.

STEP 2

Type “ **Reverie 8Q Remote** ” in the search column.

STEP 3

Select the Reverie 8Q app.



STEP 4

Click Install to download the app.

NOTE: Once the App is installed, opening the app the Bluetooth Accessory Module will connect to your device automatically.

CUSTOMER SERVICE: 800-973-8374

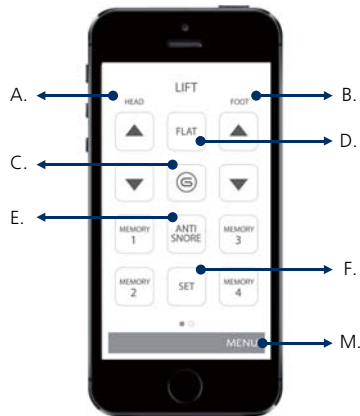

Interface Screen 1

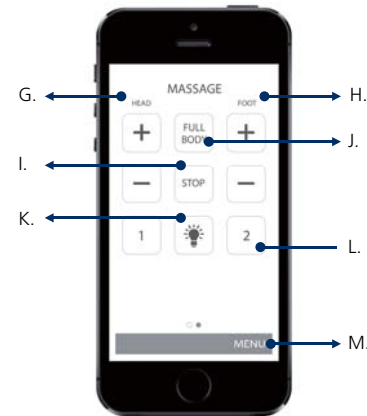

Interface Screen 2

Operating Instructions

A, B. Head and Foot adjustment:

- Raise and lower head and foot section of foundation.

C. Zero Gravity:

- Legs slightly above the chest, for better circulation.

D. Bed "FLAT" Button:

- Levels the bed: Press and hold for 3 seconds to activate button.

Note: To cancel, press buttons A or B

E. Anti-Snore:

- Raises the head slightly for easier breathing.

F. Four programmable memory buttons:

- You can store 4 personalized memory positions.
- To set a memory position, press the "set" button
- After programming the memory settings, press Memory button 1 or 4 and the bed will move to the position that you've set.

when you are in your desired position, then press the 1 or 4 memory button to lock in the position.

G, H. Head and foot massage controls:

- Starts at an intensity of 5 out of 10.
- To increase massage intensity, press (∩) button.
- To decrease massage intensity, press (∪) button.

Note: The lowest setting will turn off the corresponding massage unit.

I. Massage stop button:

- Press for 2 seconds to stop all massage features.

J. Full body massage function:

- Turns on both head and foot massage motors and alternates between Wave mode 1 & 2.

Note: You must stop the massage before you can switch to another wave function or to the full body massage.

K. Nightlight ON / OFF :

- Turns on LED lights up.

The default shut off time can be adjusted in the app.

ATTENTION:

If FLAT BUTTON (D) is pushed, massage motors will stop until bed is flat. Massage resumes in 30 seconds.

L. Wave massage mode:

- Turns on both head and foot massage motors to one of the 2 wave functions.

ATTENTION:

If FLAT BUTTON (D) is pushed, massage motors will stop until bed is flat. Massage resumes in 30 seconds.

M. Menu

Alarm, Nightlight and Customer Support

- These functions on this screen allow you to set the alarm and adjust the brightness of the nightlight under the bed. See detailed instructions below.
- If you need to contact Customer Support, our contact information is easily accessible from the app.



Alarm Function

- Set the time you'd like the alarm to wake you.
- After you've set the alarm, swipe to the next page to choose how you want the alarm to wake you.
- The "Auto" Function allows you to select whether the bed will revert to a flat position after the alarm wakes you.



Choose How The Alarm Will Wake You

- The alarm will wake you with one or a combination of the following: massage, head lift and foot lift
- Massage: Choose from intensity levels 1-10
- Head/foot lift: Choose from 1-100 (with 100 being the greatest lift)

Adjust Night Brightness:

- You will see the nightlight get brighter and dimmer as you move right or left.
- Adjust the brightness setting of the nightlight.



Customer Support

- Please contact us if you have questions or concerns about your adjustable foundation.

LED LIGHT

A. RAISE (+) / LOWER (-)
HEAD SECTION OF THE FOUNDATION

B. RAISE (+) / LOWER (-)
FOOT SECTION OF THE FOUNDATION

C. RETURN ALL SECTIONS
TO THE FLAT POSITION

D. SELECT 1 OF 4
MEMORY POSITIONS

E. ZERO GRAVITY

F. ANTI SNORE

G. INCREASE (+) / REDUCE (-)
MESSAGE INTENSITY ON
FOOT SECTION OF THE FOUNDATION

H. INCREASE (+) / REDUCE (-)
MESSAGE INTENSITY ON
HEAD SECTION OF THE FOUNDATION

I. STOP ALL MESSAGE FEATURES

L. SELECT 1 OF 2 MESSAGE
WAVE SPEEDS

K. NIGHTLIGHT ON / OFF



CUSTOMER SERVICE: 800-973-8374

HEAD AND FOOT ADJUSTMENT (A, B)

- Adjusts the head and foot sections to the desired positions.

BED “FLAT” BUTTON (C)

- Levels the bed to the flat position when the button is pressed and held for at least 1 second.

NOTE: The “FLAT” cycle can be interrupted and cancelled by pressing the head or foot adjustment buttons (A, B).

PROGRAMMABLE MEMORY BUTTONS (D)

You can store 4 personalized memory positions

- To Set a Memory Position: When in desired position, press and hold Memory button for more than 5 seconds until the LED light flashes 3 times to signal Memory position is stored.
- To Recall a Memory Position: Press Memory button 1 ~ 4 until LED lights up.

NOTE: Do not hold the Memory button for more than 5 seconds otherwise a new memory position will be set.

ZERO GRAVITY (E)

- Allows your legs to be lifted to a position slightly above the chest, which enables blood flow to easily circulate back to the heart, thus reducing stress and fatigue.

ANTI SNORE (F)

- Raises the HEAD to an upright position for anti-snore.

NIGHTLIGHT ON / OFF (K)

- Turns on LED lights up.

NOTE: The default nightlight automatically shut off time is 8 hours unless adjusted from the App.

HEAD AND FOOT MASSAGE CONTROLS (G, H)

- Turns on the corresponding massage unit (starting at intensity 5 of 10)
- Slowly increases or decreases massage intensity.
To increase massage intensity, press (+) button.
To decrease massage intensity, press (-) button.

NOTE: The lowest setting will turn off the corresponding massage unit.

MESSAGE STOP BUTTON (I)

- Press for 2 seconds to stop all massage features.

NOTE: The massage feature is designed to automatically shut off after 30 minutes of continuous use.

WAVE MESSAGE MODE (J)

- Turns on both head and foot massage motors to one of the 2 wave functions.

NOTE: You must stop the massage before you can switch to another wave function or to the full body massage.

ATTENTION: If the massage motors are operating and Head and Foot lift or Memory buttons are pressed, the massage motor will stop and resume operating after lift position reached. But if Flat button is pressed, the massage motors will not resume after flat position reached.

Additional Remote Features:

- The **8Q** adjustable foundation uses a RF (Radio Frequency) remote control system.

NOTE: This bed may have minor intermittent performance due to RF Interference. This is a normal operation of the bed and is not a defect.

- The buttons are backlit, when a button is pressed, to aid in the visibility of the remote in low light environments.
- Customers can control the remote without facing the receiver (best transmission range is within 9 feet or 3 meters).

Safety:

- If there is an overload weight condition on the head or foot mechanism, the control unit will automatically stop all functions.

NOTE: Once the excess weight is removed, the control unit will automatically start all functions after 30 seconds.

- If the massage motors are continuously used for a 30 minute period, the motors will automatically shut down.
- The input transformer voltage is AC 120V 60 HZ, the output voltage is DC 24V 3A. When there is a short circuit, a fuse on the transformer will be blown in order to protect the electrical equipment (Fuse: 1.5A).

ATTENTION: When the above situation occurs, the customer **MUST** seek professional assistance.

Notice:

The changes or modifications not expressly approved by the party responsible for compliance could void the user's authority to operate the equipment.

Important Note

- *To comply with the FCC RF exposure compliance requirements, no change to the antenna or the device is permitted. Any change to the antenna or the device could result in the device exceeding the RF exposure requirements and void user's authority to operate the device.*

**THIS DEVICE COMPLIES WITH PART 15 OF THE FCC RULES. OPERATION IS SUBJECT TO THE FOLLOWING TWO CONDITIONS:
(1) THIS DEVICE MAY NOT CAUSE HARMFUL INTERFERENCE
(2) THIS DEVICE MUST ACCEPT ANY INTERFERENCE RECEIVED, INCLUDING INTERFERENCE THAT MAY CAUSE UNDESIRE OPERATION.**

Note: The remote that comes with the bed is already paired with your bed. No further action is required. Only replacement remote controls require user programming.

STEP 1

Place batteries into the remote control (3 x AAA batteries).



STEP 2

Ensure the bed is plugged into a functioning outlet.

STEP 3

Press the learn button for 3 seconds.



Figure 1: Press “Learn Button” to initiate the RF learning Mode.

NOTE: If a new signal is not received, it will reset itself to normal mode in 10 seconds.

STEP 4

When the Green LED signature light illuminates, the RF frequency code setting function will be activated.

STEP 5

Press any button on the remote control.

STEP 6

When the receiver light flashes, you have completed the learning process of the RF frequency code.



Figure 2: A flashing Green LED indicates the control box has received the remote control signal.

PAIRING INSTRUCTIONS FOR JOINING 2 FOUNDATIONS

1 Wireless Remote Control and 2 8Q adjustable foundations

Use the same remote control to pair with the two adjustable foundations one after the other following the “Replacement Remote Control Programming” procedures (Step 3 ~ Step 6).

Your **8Q** adjustable foundation has an emergency lowering feature in the event that your adjustable foundation is in the raised position and has lost power due to a power outage.

STEP 1

Locate and remove the cover for the 9 volt batteries.



Figure 1: 9 volt batteries cover.

STEP 2

Install the two (2) alkaline 9 volt batteries.



Figure 2: Install 9 volt batteries.

STEP 3

Press the “FLAT” button (C) or the individual lowering buttons (E, G) to lower the foundation to flat position.

STEP 4

Remove the two 9 volt batteries and replace the battery cover.



Figure 3: Remove the batteries and replace the battery cover.

Your bed should lower to the flat position.

NOTE: The two (2) 9 volt batteries are only intended to be used once. After you complete the emergency lowering, the batteries need to be replaced with new alkaline batteries.

Guide for Pairing 1 Remote Control to Multiple Foundations

Each foundation is already paired with the remote control that comes with it. Each control box has space in its memory to remember two remote controls. **King/Cal King units require you to pair at least 1 remote to both foundations so that both foundations will move in sync when using that remote. You can also pair two remotes to two foundations, so that either remote can control both foundations at the same time.**

When reading these instructions assume that you have two adjustable foundations (either two TXL or two Split Cal King foundations), and two remote controls – one that came with each foundation. We will call these Foundation 1 and Foundation 2, and Remote 1 (for Foundation 1) and Remote 2 (for Foundation 2).

If you want to marry Remote 2 to foundation 1:

Take “Remote 2” and press the learn button on the PLC for “foundation 1” When the green LED lights up, press any button on “Remote 2” As soon as the LED begins to Blink, **release the button on “Remote 2” (see Steps 3-6 on Page 5). Do NOT hold the remote button after the light blinks, and do NOT press it again (see Note below). If you do you will remove Remote 1 from foundation 1’s memory.** Wait until the green LED turns solid and then turns off. Now both remotes will operate foundation 1.

If you want to marry Remote 1 to foundation 2:

Take “Remote 1” and press the learn button on the PLC for “foundation 2” When the green LED lights up, press any button on “Remote 1”. As soon as the LED begins to Blink, **release the button on “Remote 1” (see Steps 3-6 on Page 5). Do NOT hold the remote button after the light blinks, and do NOT press it again (see Note below). If you do you will remove Remote 2 from foundation 2’s memory** Wait until the green LED turns solid and then turns off. Now both remotes will operate both foundations in Tandem.

Note: While the light is blinking if you release the button on the remote and press it a second time, or if you continue to hold the button the PLC can jump to the second slot and kick out the first remote. This is why some people have a difficult time joining the remotes. If they are patient and follow the process described they will not have a problem.



To avoid accident or injury, please read the Mfollowing instructions before use.

1. The stand is for indoor use only.
2. To reduce the risk of electrical shock or fire, don't expose the unit to rain or excessive moisture.
3. Plug the remote stand into the power strip as in the diagram to avoid a short circuit.
4. To avoid electrical shock, do not insert objects other than electrical plugs into outlet openings.
5. Before use, please ensure local voltage and power are in accordance with the remote stand requirements.
6. Do not make any changes or modifications to the remote stand.
Failure to comply will void the manufacturer's warranty.
7. Do not use the stand if the stand has been damaged in any way.
8. Please don't attempt to disassemble the remote stand.
9. To clean, unplug the remote stand from the power strip and use a damp cloth.

I. Profile of Remote Stand

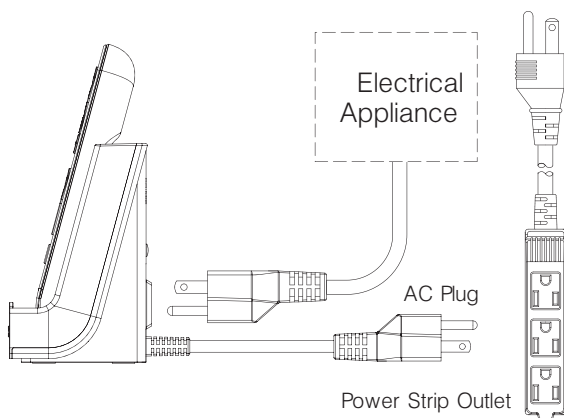

INSTALLATION DIAGRAM

II. Installation

1. Refer to drawing in Part I. Plug the remote stand into the 120V AC power strip outlet under the bed.
2. Plug light electrical devices into the remote stand outlets as desired.
3. Plug USB cord in front to charge your mobile devices.
4. Place your remote in the cradle of the front side of the stand for storage.

III. Specifications

1. Model Number: RC-STAND-R02
2. Power Rating: AC120V, 300W
3. Housing: ABS
4. Indicator Lamp: 1/4 W power on lamp
5. Outlets: 2 outlets on back of stand
6. Cable: 1.8M / UL
7. Surge Protection: 125 joules
8. USB Charger : 5V, 1A

Caution:

This device is only to be used to control light household electrical appliances such as lamps, phone chargers, and laptop computers. You should never plug heaters or other items with heating elements into this device.

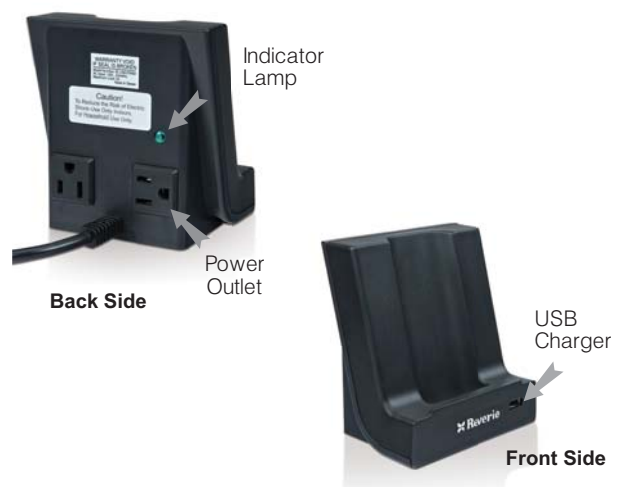

CUSTOMER SERVICE: 800-973-8374

In the Event the **8Q** adjustable foundation fails to operate, investigate the symptoms and possible solutions provided in the chart below :

SYMPTOM	SOLUTION
Remote control LED illuminates and appears to be operable but will not activate the bed.	<ul style="list-style-type: none"> • Verify the power cord is plugged into a working, grounded electrical outlet. A grounded, electrical surge protection device is recommended. Test the outlet by plugging in another working appliance.
No features of the 8Q adjustable foundation will activate.	<ul style="list-style-type: none"> • Program the remote control (see the Remote Control Guide, included with this product, for programming procedures). If equipped with a power down box, make certain the power down box is easily accessible. Relocate the power down box if required. • Unplug the power cord, wait 45 seconds and plug it in to reset the electronic components. • The electrical circuit breaker may be tripped. Check the electrical service breaker box to verify. • The surge protection device or electrical outlet is defective. Test the outlet by plugging in another working appliance.
Remote control LED will not illuminate.	<ul style="list-style-type: none"> • Replace the batteries in the hand control. Ensure the batteries are installed correctly.
Head or foot section will elevate but will not return to the horizontal (flat) position.	<ul style="list-style-type: none"> • The bed mechanism may be obstructed. Elevate the bed and check for an obstruction. Remove the obstruction. • The head section may be too close to the wall. The headboard may be too close to the edge of the mattress. Verify a 1.5" (38.1mm) to 2" (50.8mm) distance is between the headboard brackets and the mattress. Adjust if required.
Head or foot lift function has minor interference during operation.	<ul style="list-style-type: none"> • Check batteries in remote, replace if necessary. Make sure that you are following the duty cycle of the motors (do not operate more than three (3) minutes over a thirty (30) minute period, approximately 10% duty cycle). • Press the lift buttons squarely & accurately. Remote may be experiencing common Radio Frequency Interference from other radio transmitting devices.
Excessive massage motor noise.	<ul style="list-style-type: none"> • If the bed is located on hard surface flooring, place carpet pieces. • Elevate the head or foot section a short distance (with the hand control) to realign the lift/lower mechanisms with the bed support platform. • Verify that the bed is not positioned against a wall, nightstand, or other object that may cause the vibration or noise. • If the 8Q is installed over a bed frame, verify the massage motors are not causing the bed frame (or bed frame components) to vibrate. • Verify that the headboard attachment hardware is firmly tightened (if used).

CUSTOMER SERVICE: 800-973-8374



25 YEAR LIMITED WARRANTY

Register Online. For easy registration of your warranty visit www.reverie.com

Please prepare a digital copy of your proof of purchase (invoice or sales receipt) when registering online.

1-Year Parts and Labor Warranty

Your 8Q™ adjustable foundation is warranted by the manufacturer against defects in materials or workmanship for a period of one year from the date of purchase to the original Purchaser. During such time, the manufacturer will repair or replace, at no cost to the original Purchaser any warranted part found to be defective by the manufacturer, in its sole discretion. This includes all pre-authorized labor and transportation costs incurred with the repair or replacement of any warranted part found to be defective. This warranty does not apply to 8Q™ adjustable foundation floor models. This one (1) year warranty does not apply if Purchaser does not return all defective parts to the manufacturer within 15 days of Purchaser's receipt of replacement part(s).

2-Year Motor Warranty

Your 8Q™ adjustable foundation linear actuators are warranted by the manufacturer against defects in materials or workmanship for a period of two (2) years from the date of purchase to the original Purchaser. During such time, the manufacturer will repair or replace, at no cost to the original Purchaser any warranted linear actuator found to be defective by the manufacturer, in its sole discretion. This includes all pre-authorized labor and transportation costs incurred with the repair or replacement of any warranted part found to be defective by the manufacturer, in its sole discretion. This warranty does not apply to 8Q™ adjustable foundation floor models. This two (2) year warranty does not apply if Purchaser does not return all defective parts to the manufacturer within 15 days of Purchaser's receipt of replacement part(s).

Years 2 through 5 – Coverage of Parts Only

During Year 2 through 5 from the original purchase date, the manufacturer will replace any warranted part on the adjustable foundation found to be defective by the manufacturer, in its sole discretion, to the original Purchaser. The manufacturer's liability is limited to the replacement of the defective warranted electrical/mechanical part(s)* ONLY with the original Purchaser responsible for all service, installation, handling, shipping, and transportation cost of said part(s) (except where prohibited by law). This warranty does not apply to 8Q™ adjustable foundation floor models. This warranty does not apply if Purchaser does not return all defective parts to the manufacturer within 15 days of Purchaser's receipt of replacement part(s).

25-Year Limited Warranty

During Year 6 through 25 from the original purchase date, the manufacturer will replace, within the terms and conditions set forth in this paragraph, any 8Q™ adjustable foundation mechanical part(s)* found to be defective by the manufacturer, in its sole discretion to the original Purchaser.

Purchaser shall pay 1/20 of the current replacement cost of the defective part multiplied by the number of years after the fifth year, from the original purchase date. This warranty applies only to the replacement part(s); the Purchaser will be responsible for all service, installation, handling, shipping, and transportation cost of said part(s). Purchaser may also be subject to other charges for said part(s). The manufacturer's liability shall be limited to the replacement of the defective part(s) ONLY with the Purchaser responsible for all service, installation and freight cost for said part(s) (except where prohibited by law). This warranty does not apply to 8Q™ adjustable foundation floor models. This warranty does not apply if Purchaser does not return all defective parts to the manufacturer within 15 days of Purchaser's receipt of replacement part(s).

2-Year Floor Model Warranty

Your 8Q™ adjustable foundation floor model is warranted against defects in warranted electronic parts for a period of two (2) years from the date of purchase to the original Purchaser. During the first two (2) years the manufacturer will replace at no cost to the original Purchaser, any defective electronic part(s) determined to be defective by the manufacturer, in its sole discretion. The manufacturer's liability is limited to the replacement for the defective electronic part(s) ONLY with the Purchaser responsible for all service, installation, handling, shipping, and transportation cost of said part(s). This two (2) year warranty does not apply if Purchaser does not return all defective parts to the manufacturer within 15 days of Purchaser's receipt of replacement part(s).

*Warranted Parts under this 8Q™ Warranty are as follows:

- a) Head/Foot Linear Actuator
- b) Massage Motors and Housing
- c) Control Box with Power Supply
- d) Remote Control
- e) Mounting Brackets
- f) Support Struts

Additional terms and conditions apply. See next page for details.

Manufactured by Reverie®
 For warranty service, call Customer Service
1-800-973-8374
 341 Central Avenue, Silver Creek, NY 14136
 customerservice@reverie.com www.reverie.com

Name _____

Phone _____

Address _____

City _____ State/Province _____ ZIP/Postal Code _____

Purchase date _____

Foundation Serial Number _____

Email Address _____

To register your warranty via mail, send this portion and a copy of your proof of purchase (invoice or sales receipt) to:
Reverie Warranty Dept. 341 Central Avenue, Silver Creek, NY 14136 (1-800-695-2540)

ADDITIONAL TERMS & CONDITIONS

This warranty does not include reimbursement for inconvenience, removal, part(s) installation, foundation set up, loss of use, normal wear and tear, shipping or any other costs or expenses not expressly covered in this warranty. To the extent permitted by law, the determination of whether any part and/or workmanship is defective and the decision to repair and/or replace any defective parts under this Limited Warranty shall be made exclusively by the manufacturer in its sole and absolute discretion.

In addition, this warranty shall be void in the following circumstances:

- A. Any damage resulting from any misuse or abuse caused by the Purchaser or any third party.
- B. Any damage caused by repairs or parts replacement by any unauthorized person(s).
- C. Damage caused if the adjustable foundation has been mishandled (including during shipping, transit, or by other means), subject to physical or electrical misuse or abuse, or by failing to adhere to the Owner's Manual and this warranty including the operation of the adjustable foundation in any way inconsistent with the operation and maintenance procedures in the Owner's Manual.
- D. Damaged mattresses, foundation cover(s), fabric(s), bedding cables, electrical cords or accessories supplied by dealers or any third party. Contact your dealer for warranty information on these items.
- E. Modification of the 8Q™ adjustable foundation without prior written consent by the manufacturer.
- F. Costs for unauthorized service calls for the purpose of educating the consumer about the 8Q™ adjustable foundation, locating proper functioning power outlets, or installing batteries.
- G. Damage if the recommended weight restrictions are exceeded.
- H. Damage if used in any environment or a commercial setting which was not intended.
- I. Damage to foam shroud, fabric cover, or wooden support by improper handling or misuse.

The following exclusions/limitations are inapplicable to consumers residing in Québec:

OTHER THAN AS EXPRESSLY SET OUT HEREIN, AND TO THE EXTENT PERMITTED BY APPLICABLE LAW, THIS WARRANTY IS EXCLUSIVE AND IN LIEU OF ALL OTHER ORAL OR WRITTEN WARRANTIES, REPRESENTATIONS, CONDITIONS OR PROMISES, WHETHER EXPRESS OR IMPLIED, AND WHETHER ARISING BY LAW, STATUTE, COURSE OF DEALING OR USAGE OF TRADE, INCLUDING, BUT NOT LIMITED TO, IMPLIED WARRANTIES AND CONDITIONS OF MERCHANTABILITY, QUALITY, DURABILITY AND/OR FITNESS FOR A PARTICULAR PURPOSE. TO THE EXTENT PERMITTED

BY APPLICABLE LAWS, ANY IMPLIED WARRANTIES (IF APPLICABLE) ARE LIMITED IN DURATION TO THE DURATION OF THIS WARRANTY. TO THE EXTENT PERMITTED BY APPLICABLE LAW, IN NO EVENT SHALL THE MANUFACTURER BE LIABLE FOR ANY SPECIAL, INCIDENTAL, PUNITIVE, EXEMPLARY, CONSEQUENTIAL OR SIMILAR DAMAGES, WHETHER OR NOT FORESEEABLE.

To the extent permitted by law, this warranty is not transferable and will automatically terminate if the original Purchaser sells or otherwise disposes of the 8Q™ adjustable foundation.

This warranty gives the Purchaser specific legal rights. Other rights, which vary from jurisdiction to jurisdiction, may exist. In addition, some jurisdictions do not allow (i) the exclusion of certain warranties, (ii) limitations on how long an implied warranty lasts and/or (iii) the exclusion or limitation of certain types of costs and/or damages, so the above limitations may not apply. This warranty is only valid in The United States, Canada and Puerto Rico. The laws of the Purchaser's state/province of residence shall govern this warranty.

REPAIR OR REPLACEMENT SHALL BE THE SOLE REMEDY OF THE PURCHASER. THERE SHALL BE NO LIABILITY ON THE PART OF ASCION, L.L.C., AND ITS PARENTS, SUBSIDIARIES, DIVISIONS OR AFFILIATES FOR ANY SPECIAL, INDIRECT, INCIDENTAL, OR CONSEQUENTIAL DAMAGES OR FOR ANY OTHER DAMAGE, CLAIM, OR LOSS NOT EXPRESSLY COVERED BY THE TERMS OF THIS WARRANTY.

To the extent permitted by law, this Limited Warranty does not include reimbursement for inconvenience, removal, installation, setup time, loss of use, shipping, or any other costs or expenses.

Where any term of this Limited Warranty is prohibited by local law, such term shall be null and void or shall be deemed modified so as to be consistent with local law, and, in either case, the remainder of this Limited Warranty shall remain in effect.

Weight Limits:

This product is not rated to support weights in excess of 850 pounds inclusive of the mattress and bedding. The foundation will structurally support this weight, provided it is evenly distributed across the top surface of the foundation base. The adjustable foundation is not designed to support or lift this amount in the head or foot sections alone, and it is not designed to lift this amount of weight. The amount of weight the foundation can lift without exceeding the safety shut-off threshold for the control box depends on distribution of weight and how well the mattress on top of the foundation bends with the adjustable foundation. Exceeding this weight restrictions or loading weight on the foundation unevenly or using a mattress that is not designed to flex well with an adjustable foundation could damage the bed and/or cause injury and will void the warranty.

Manufactured by Reverie® .
For warranty service, call Customer Service
1-800-973-8374
341 Central Avenue, Silver Creek, NY 14136
customerservice@reverie.com www.reverie.com

Register Online. For easy registration of your warranty visit www.reverie.com

Please prepare a digital copy of your proof of purchase
(invoice or sales receipt) when registering online.

Manufactured by Reverie®.

For Warranty and Service:

800-973-8374

customerservice@reverie.com

341 Central Ave. Silver Creek, NY 14136

www.reverie.com



Name _____

Phone _____

Address _____

City _____ State/Province _____ ZIP/Postal code _____

Purchase date _____

Bed Serial Number _____

Email Address _____

To register your warranty via mail, send this portion and a copy of your proof of purchase
(invoice or sales receipt) to:

Reverie Warranty Dept. 341 Central Ave. Silver Creek, NY 14136 (800-973-8374)