



Brookstone®

---

**FLIGHTFORCE™**  
MICRO VIDEO DRONE

For ages 14+

317918\_317919 Micro Video Drone  
Size:4"Wx4"H\_Output:100%\_Prints:1/1\_Blk

## TABLE OF CONTENTS

Warnings and Cautions.....	2
FCC Information .....	12
Location of Parts and Controls.....	14
Controller Battery Installation.....	16
Charging the Micro Video Drone Battery .....	17
Syncing the Micro Video Drone .....	19
Preparing for Flight .....	21
Flying Tips.....	22
Recognizing the Front and Rear of the Micro Video Drone ..	23
Flight Controls.....	24
Speed Selection .....	28
Understanding Trim Adjustments .....	29
Performing a 360° Stunt Roll.....	32
Level Surface Gyro Calibration.....	33
Low Battery Warning.....	34

Using the On-Board Camera and Video Recorder.....	35
Replacing The Propeller Blades.....	39
Troubleshooting.....	40
Care and Maintenance .....	42
Micro Video Drone Specifications.....	43
Warranty .....	44

## CAUTION

- TO REDUCE THE RISK OF ELECTRIC SHOCK, DO NOT REMOVE COVER.  
THERE ARE NO SERVICEABLE PARTS INSIDE.
- TO REDUCE THE RISK OF FIRE OR ELECTRIC SHOCK, DO NOT EXPOSE THIS UNIT TO RAIN OR MOISTURE.



The lightning flash with arrow-head symbol within an equilateral triangle is intended to alert the user to the presence of uninsulated "dangerous voltage" within the unit's enclosure that may be of sufficient magnitude to constitute a risk of electric shock.



The exclamation point within an equilateral triangle is intended to alert the user to the presence of important operating and maintenance (servicing) instructions in the literature accompanying the unit.

## IMPORTANT SAFETY INSTRUCTIONS

All of the safety and operating instructions should be read, adhered to and followed before the unit is operated.

## SAVE THESE INSTRUCTIONS

## MICRO VIDEO DRONE WARNINGS:

1. The Micro Video Drone is designed for INDOOR or OUTDOOR flight.
2. The Micro Video Drone's blades revolve at high speeds and can cause damage to the user, spectators and animals. Stand away from the Micro Video Drone to reduce the risk of getting into the flight path and always maintain visual contact with the Micro Video Drone while flying.
3. Warn spectators that you will be flying your Micro Video Drone so that they are aware of its position.
4. Before flight, inspect the rotor blades to make certain that the blades are securely fastened to the Micro Video Drone.
5. Before flying, check your local laws and regulations pertaining to drone usage.
6. It is recommended to operate the Micro Video Drone in a wide open space. The ideal space should have a 200-foot radius.
7. Parental guidance or adult supervision is suggested at all times.
8. If you are flying the Micro Video Drone with others, make sure all spectators are behind you.
9. For best performance, it is recommended that you operate the Micro Video Drone in zero wind conditions, as wind can greatly affect the performance of the aircraft.
10. Record responsibly. Respect the privacy of individuals when recording video or taking photos with the Micro Video Drone.
11. Obtain permission from individuals before circulating videos or photos taken with the Micro Video Drone.

**CAUTION: DO NOT ATTEMPT TO FLY THE MICRO VIDEO DRONE IF THERE IS RAIN, SNOW, HEAVY WINDS, THUNDER OR LIGHTNING OUTDOORS. IT COULD DAMAGE YOUR PRODUCT AND MAY CAUSE BODILY HARM.**



## WARNING!

- Choking/Cutting Hazard. Small Parts/Sharp Rotor Blades.
- Keep hands, hair and loose clothing away from the propeller when the power switch is turned to the ON position.
- Turn off the controller and Micro Video Drone power switches when not in use.
- Not suitable for children under 14 years old. Parental supervision recommended when flying the Micro Video Drone.



## BATTERY WARNINGS

### RECHARGEABLE BATTERY (Micro Video Drone):

This device contains a non-removable Lithium-Polymer battery. The included charger is built specifically for the Micro Video Drone Li-Poly battery. Do not use it to charge any other battery. The battery must be recycled or disposed of properly. Contact your local waste management office for information on battery recycling or disposal.



### CONTROLLER BATTERIES:

- New alkaline batteries are recommended for maximum performance.
- Do not mix alkaline, standard (carbon-zinc) and rechargeable batteries (Nickel Metal Hydride).
- Do not mix old and new batteries.
- Non-rechargeable batteries are not to be recharged.

- Rechargeable batteries are to be removed from the item before being charged (if removable).
- Rechargeable batteries are only to be charged under adult supervision.
- Exhausted batteries should be removed immediately and must be recycled or disposed of properly according to state or local government ordinances and regulations.
- The supply terminals are not to be short-circuited.
- Only batteries of the same or equivalent type as recommended are to be used.
- Batteries are to be inserted with the correct polarity.
- Do not dispose batteries in a fire - batteries may leak or explode.

## **DANGER**

To reduce the risk of electric shock, burns, fire or injury:

1. Do not use while bathing or in a shower.
2. Do not place or store unit where it can fall or be pulled into a tub or sink.
3. Do not place in, drop or submerge in water or other liquid.
4. Do not reach for a unit that has fallen into water. Unplug it immediately.
5. Care should be taken so that objects do not fall and liquids are not spilled onto the unit.

## WARNING

1. Close supervision is necessary when this appliance/product is used by or near children or mentally disabled individuals.
2. Use this unit only for its intended use as described in this manual.
3. Unplug this unit during lightning storms or when unused for long periods of time.
4. Never drop or insert an object into any opening.
5. Protect the power cord from being walked on or pinched, particularly at plug outlets, convenience receptacles and the point where it exits the unit.
6. Do not allow cord to touch hot surfaces. Wrap cord loosely around the unit when storing.
7. The unit should be situated away from direct sunlight or heat sources such as radiators, electric heaters, heat registers, stoves, or other units (including amplifiers) that produce heat. Avoid placing on top of stereo equipment that radiates heat.
8. Never block the air openings of the unit with materials such

as clothing, plastic bags or papers, or place it on a soft surface such as a bed or couch, where the air openings may be blocked.

9. Do not overload the electrical outlet. Use only the power source as indicated.
10. Do not carry this unit by its cord or use the cord as a handle.
11. Never operate this unit if it has a damaged cord or plug, if it is not working properly, or if it has been dropped or damaged, or dropped into water. If the unit's power supply cord or plug is damaged, do not attempt to fix it yourself.
12. To avoid the risk of electric shock, do not disassemble or attempt to repair the unit. Incorrect repair can cause risk of electric shock or injury to persons when the unit is used.
13. Do not operate in the presence of explosive and/or flammable fumes.
14. Never remove the plug from the outlet by pulling the power cord.

## FCC INFORMATION

**Caution:** Changes or modifications not expressly approved by the party responsible for compliance could void the user's authority to operate the equipment.

This equipment has been tested and found to comply with the limits for a Class B Digital Device, pursuant to Part 15 of the FCC Rules. These limits are designed to provide reasonable protection against harmful interference in a residential installation. This equipment generates, uses, and can radiate radio frequency energy and, if not installed and used in accordance with the instructions, may cause harmful interference to radio communications. However, there is no guarantee that interference will not occur in a particular installation.

If this equipment does cause harmful interference to radio or television reception, which can be determined by turning the equipment off and on, the user is encouraged to try to correct the interference by one or more of the following measures:

- Reorient or relocate the receiving antenna.
- Increase the distance between the equipment and receiver.

- Connect the equipment to an outlet on a circuit different from that to which the receiver is connected.
- Consult the dealer or an experienced radio/TV technician for help.

This equipment complies with Part 15 of the FCC Rules. Operation is subject to the following two conditions:

1. This equipment may not cause harmful interference.
2. This equipment must accept any interference received, including interference that may cause undesired operation.

Modifications not authorized by the manufacturer may void the user's authority to operate this device.



## LOCATION OF PARTS AND CONTROLS

- |                            |                          |
|----------------------------|--------------------------|
| 1. Front Rotor Blades (2)  | 5. Rear Rotor Blades (2) |
| 2. Front LED Indicator (2) | 6. microSD Card Slot     |
| 3. Camera                  | 7. On/Off Switch         |
| 4. Rear LED Indicator (2)  | 8. USB Charging Port     |

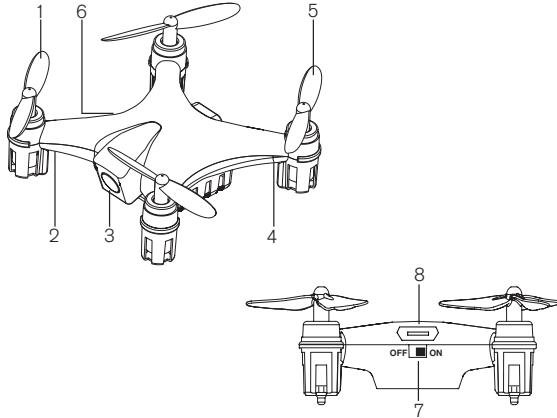

## LOCATION OF PARTS AND CONTROLS

- |                              |                             |
|------------------------------|-----------------------------|
| 9. Speed Button              | 15. On/Off Switch           |
| 10. Throttle Control Stick   | 16. Left Trim Button        |
| 11. Rotate Left Trim Button  | 17. Right Trim Button       |
| 12. Rotate Right Trim Button | 18. Direction Control Stick |
| 13. Forward Trim Button      | 19. Camera Button           |
| 14. Backward Trim Button     | 20. Power LED Indicator     |

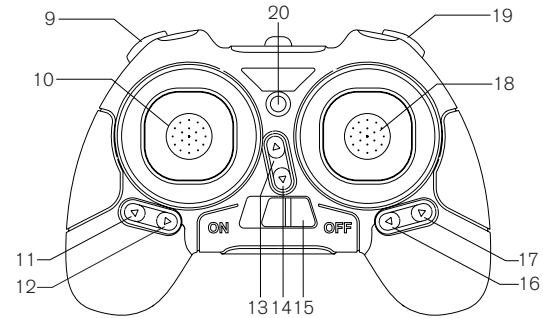

## CONTROLLER BATTERY INSTALLATION

1. Unscrew the battery cover from the back of the controller as shown in figure A.
2. Install 2 AAA alkaline batteries (not included) into the controller as shown in figure B.
3. Replace the battery cover.
4. Turn over the controller and turn the ON/OFF SWITCH to the ON position. The POWER LED INDICATOR will flash red to indicate the batteries are installed correctly.

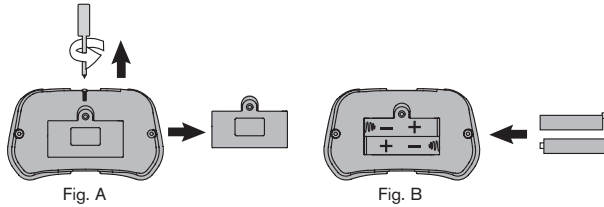

## CHARGING THE MICRO VIDEO DRONE BATTERY

1. Switch the Micro Video Drone OFF. Insert the included USB cable into the USB CHARGING PORT as shown in figure C.

**Note:** The USB plug fits into the USB CHARGING PORT in one way only. Do not force it. Improper connection will damage the Micro Video Drone.

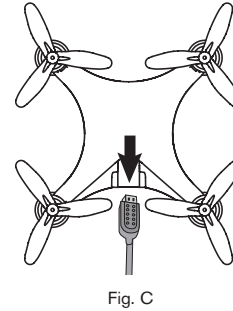

2. Connect the USB end of the cable to your computer's USB port as shown in figure D.

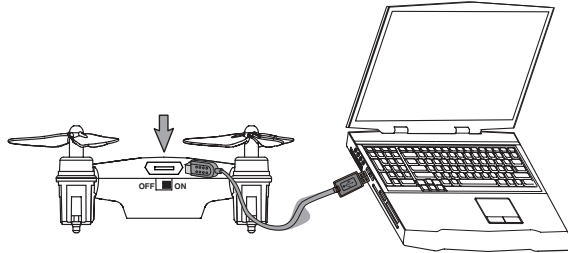

Fig. D

3. The red LED on the USB plug turns on when charging is complete. Average charging time is 40 minutes.

**Note:** The red LED on the USB plug turns on when connected to a power source. When the USB plug is connected to the Micro Video Drone, the red LED will turn off. When the Micro Video Drone is fully charged the red LED will turn on. A full charge will allow for about 5-6 minutes of flight time. Unplug the charging cord when not in use.

## SYNCING THE MICRO VIDEO DRONE

**Important!** When syncing the Micro Video Drone with the controller, always make sure that the Micro Video Drone is on a flat level surface and that your digital trim settings are in the center position. This ensures that the 6-axis gyro is properly programmed to mimic your trim settings.

The Micro Video Drone utilizes an automatic 2.4Ghz channel selection system that allows up to 8 people to fly side by side in the same wireless range with no interference.

## FOR ONE-PERSON PLAY

1. Before starting, make sure that the power switches on both the controller and the Micro Video Drone are in the OFF position. Make sure that there are no other 2.4Ghz devices in the area.
2. Turn the Micro Video Drone ON and set it down on a flat surface. The FRONT AND REAR LED INDICATORS will begin to flash rapidly.
3. Turn the controller ON, one beep will sound. The FRONT AND REAR LED INDICATORS will flash slowly.

4. Push the THROTTLE CONTROL STICK all the way forward (one beep will sound) and then pull the THROTTLE CONTROL STICK all the way back. A second beep will sound and the FRONT AND REAR LED INDICATORS will be solid, indicating the controller and the Micro Video Drone are successfully synced. If not, repeat above steps.

#### FOR MULTI-PERSON PLAY

5. Before starting, make sure that the power switches on both the controller and the Micro Video Drone are in the OFF position. Make sure that there are no other 2.4G devices in the area.
6. Each person needs to sync their Micro Video Drone at a different time to avoid interference. Follow steps 1 to 4 above ensuring that no one else is syncing at the same time.
7. After syncing, each player's Micro Video Drone should be left ON until all players have synced their Micro Video Drones.
8. Should there be interference, all players must turn off their controllers and Micro Video Drone for up to 60 seconds and then begin the syncing process again.

#### PREPARING FOR FLIGHT

1. Verify that there are 2 AAA batteries inside the remote control unit and the Micro Video Drone has been fully charged.
2. Confirm your Micro Video Drone and controller are both turned on.
3. Make sure to be in a large space with an open radius of at least 50 feet.
4. Make sure the empty space has no obstacles or water close by.
5. Place the Micro Video Drone on a clean, flat surface before takeoff.

**CAUTION: DO NOT ATTEMPT TO FLY THE MICRO VIDEO DRONE IF THERE IS RAIN, SNOW, HEAVY WINDS, THUNDER OR LIGHTNING OUTDOORS. IT COULD DAMAGE YOUR PRODUCT AND MAY CAUSE BODILY HARM.**

## FLYING TIPS

- It is recommended to operate the Micro Video Drone in a wide open space. The ideal space should have a 200-foot radius.
- Parental guidance or adult supervision is suggested at all times.
- If you are flying the Micro Video Drone with others, make sure all spectators are behind you.
- For best performance, it is recommended that you operate the Micro Video Drone in zero wind conditions, as wind can greatly affect the performance of the aircraft.

## RECOGNIZING THE FRONT AND REAR OF THE MICRO VIDEO DRONE

The Micro Video Drone has a “front” and a “rear.”

The front and forward-facing direction of the Micro Video Drone is the side with the CAMERA as shown in figure E. The LED indicators on the front of the Micro Video Drone are white.

The rear and backward-facing direction of the Micro Video Drone is the side with USB CHARGING PORT as shown in figure E. The LED indicators on the rear of the Micro Video Drone are red.

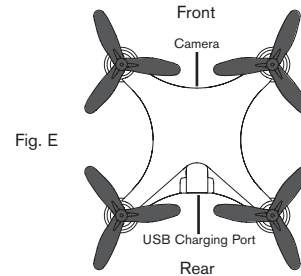

## FLIGHT CONTROLS

Below is a list of basic flight functions. While learning to fly the Micro Video Drone, it is best to start in a large space until you get used to the basic controls. As you master flying your Micro Video Drone, you can move to more advanced maneuvering techniques.

1. Move the THROTTLE CONTROL STICK upward to increase the speed of the propellers and the Micro Video Drone will accelerate upward and ascend. Move the THROTTLE CONTROL STICK down to decrease the speed and the Micro Video Drone will decelerate and descend (see figure F).

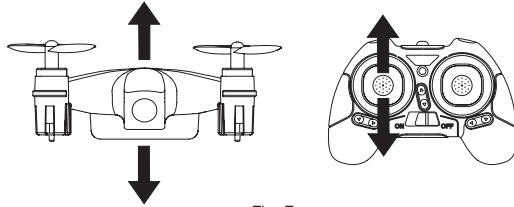

Fig. F

2. While in the air, move the THROTTLE CONTROL STICK left and the Micro Video Drone will rotate left. Move the THROTTLE CONTROL STICK right and the Micro Video Drone will rotate right (see figure G).

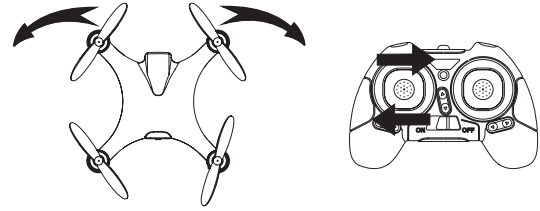

Fig. G

3. While in the air, move the DIRECTION CONTROL STICK up and the Micro Video Drone will move forward. Move the DIRECTION CONTROL STICK down and the Micro Video Drone will move backward (see figure H).

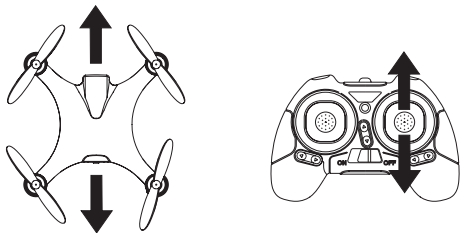

Fig. H

4. While in the air, move the DIRECTION CONTROL STICK left and the Micro Video Drone will bank to the left. Move the DIRECTION CONTROL STICK right and the Micro Video Drone will bank to the right (see figure I).

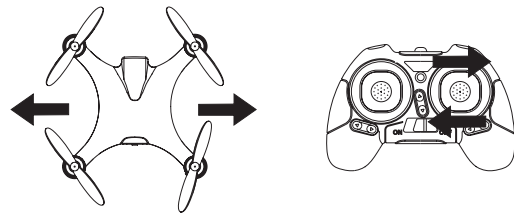

Fig. I

## SPEED SELECTION

The Micro Video Drone has 3 speed settings: Low, Medium and High. Low speed is the default setting.

1. Press the SPEED BUTTON to change to Medium Speed. Two beeps will sound.
2. Press the SPEED BUTTON to change to High Speed. Three beeps will sound.
3. Press the SPEED BUTTON to change to Low Speed. One beep will sound.

## UNDERSTANDING TRIM ADJUSTMENTS

### FORWARD/BACKWARD TRIM

- If the Micro Video Drone is drifting forward or backward, the FORWARD/BACKWARD TRIM may need to be adjusted.
- If the Micro Video Drone drifts forward, push and release the BACKWARD TRIM BUTTON repeatedly until the motion stops and proper flight is maintained.
- If the Micro Video Drone drifts backward, push and release the FORWARD TRIM BUTTON repeatedly until the motion stops and proper flight is maintained.
- The FORWARD or BACKWARD TRIM may need to be adjusted during use to ensure the Micro Video Drone will hover in mid-air and respond accurately to commands.



## RIGHT/LEFT TRIM

- If the Micro Video Drone is drifting left or right, the LEFT/RIGHT TRIM may need to be adjusted.
- If the Micro Video Drone drifts left, push and release the RIGHT TRIM BUTTON repeatedly until the motion stops and proper flight is maintained.
- If the Micro Video Drone drifts right, push and release the LEFT TRIM BUTTON repeatedly until the motion stops and proper flight is maintained.
- The LEFT or RIGHT TRIM may need to be adjusted during use to ensure the Micro Video Drone will hover in mid-air and respond accurately to commands.

## ROTATE RIGHT/LEFT TRIM

- If the rotation of the Micro Video Drone is drifting left or right, the ROTATE LEFT/ROTATE RIGHT TRIM may need to be adjusted.
- If the rotation of Micro Video Drone drifts left, push and release the ROTATE RIGHT TRIM BUTTON repeatedly until the motion stops and proper flight is maintained.
- If the rotation of Micro Video Drone drifts right, push and release the ROTATE LEFT TRIM BUTTON repeatedly until the motion stops and proper flight is maintained.
- The ROTATE LEFT or ROTATE RIGHT TRIM may need to be adjusted during use to ensure the Micro Video Drone will hover in mid-air and respond accurately to commands.

## PERFORMING A 360° STUNT ROLL

1. Once the Micro Video Drone is airborne, press the DIRECTION CONTROL STICK straight down.
2. Move the lever in the direction you wish to perform the 360° roll as shown in figure J.

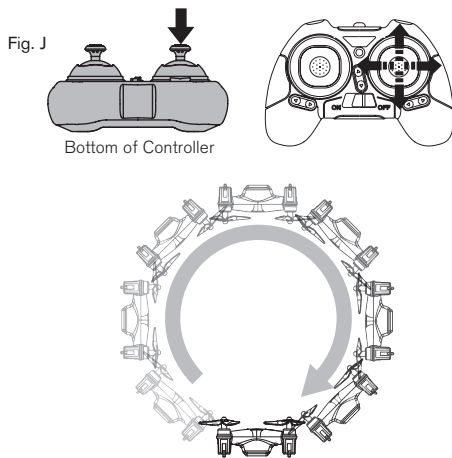

## LEVEL SURFACE GYRO CALIBRATION

If the Micro Video Drone becomes unstable during the course of flying, or after a crash, the onboard gyro chip may need to be recalibrated.

1. Place the Micro Video Drone on a flat level surface.
2. Sync the controller and the Micro Video Drone (see page 19 for syncing instructions).
3. Pull the DIRECTION CONTROL STICK all the way down and to the right (approximately 45°) and hold for a couple of seconds. The FRONT AND REAR LED INDICATORS on the Micro Video Drone will flash quickly.
4. Release the control stick and the FRONT AND REAR LED INDICATORS on the Micro Video Drone will turn solid to indicate the Micro Video Drone has been stabilized.

## LOW BATTERY WARNING

### CONTROLLER

When the controller batteries are low, the POWER LED INDICATOR will turn on. Land the Micro Video Drone slowly and replace the batteries.

### DRONE

When the Micro Video Drone's battery is low, the FRONT AND REAR LED INDICATORS will flash. Land the Micro Video Drone slowly and recharge.

**WARNING:** Do not attempt a 360° flip when the Micro Video Drone's battery is low.

## USING THE ON-BOARD CAMERA AND VIDEO RECORDER

### FORMATTING YOUR microSD CARD

The included microSD card must be formatted before videos or photos can be saved.

To format the microSD card, insert the microSD CARD into the included microSD USB card reader and plug it into your computer's USB port as shown in figure K. An icon will appear on your computer's desktop. Right-click on the icon and follow instructions to format your microSD card.

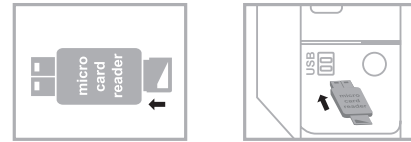
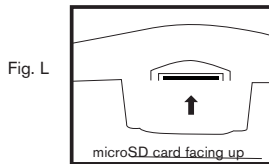

Fig. K

## INSTALLING THE microSD CARD IN THE MICRO VIDEO DRONE

1. Place the formatted microSD card into the microSD CARD SLOT and push gently until a “click” is heard as shown in figure L.



2. Ensure the Micro Video Drone is synced to the controller (see page 19 for syncing instructions).
3. The REAR LED INDICATORS will be solid when the microSD card is successfully installed.

**NOTE:** The REAR LED INDICATORS will rapidly flash to indicate the microSD card is not installed correctly or there is a problem with the card.

## TAKING PHOTOS

Press the CAMERA BUTTON to take a photo. A beep will sound and the REAR LED INDICATORS will flash to confirm the photo has been taken. When the REAR LED INDICATORS return to solid, another photo can be taken.

## RECORDING VIDEOS

Press and hold the CAMERA BUTTON for 3 seconds to start recording a video. The REAR LED INDICATORS will flash constantly to indicate that a video is recording.

Press the CAMERA BUTTON to stop recording. When the REAR LED INDICATORS return to solid, another video can be recorded.

**Note:** When the microSD card is full, the REAR LED INDICATORS will not flash when the CAMERA BUTTON is pressed to indicate there is no memory space on the card.

## REMOVING THE microSD CARD

To remove the microSD card, push in gently on the back of the card until a "click" is heard. The microSD card will "pop out" slightly and is ready for removal. Gently pull the microSD card to remove.

## REPLACING THE PROPELLER BLADES

The Micro Video Drone's propeller system is a precision instrument that may need repair or replacement for optimal flight function. Crash landing from high-speed aerial flights may cause damage to your Micro Video Drone's propellers.

1. The Micro Video Drone has four blades that are labeled with an embossed A or B as shown in figure M.
2. When replacing the propeller blades (included), gently remove the blade from the rotor shaft.
3. Replace the damaged blade with the new blade. Make sure to place the A or B propellers in the correct positions as shown figure M.

Front Left=A  
Front Right=B  

---

Rear Left=B  
Rear Right=A

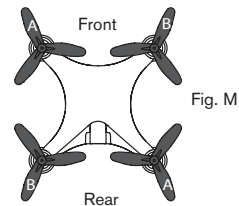

## TROUBLESHOOTING

ISSUE	SOLUTION
No power (controller)	Switch the ON/OFF switch to ON. Make sure all batteries are installed correctly (see diagram B on page 16). Replace batteries.
No power (Micro Video Drone)	Recharge the Micro Video Drone.
Controller not responding	Switch the ON/OFF switch to ON on the controller. Switch the ON/OFF switch to ON on the Micro Video Drone. Conditions are too windy. Replace batteries.
Micro Video Drone not responding	Calibrate gyro (see instructions on page 33).

## TROUBLESHOOTING (CONTINUED)

ISSUE	SOLUTION
Micro Video Drone won't lift off	Push THROTTLE CONTROL STICK forward. Recharge the Micro Video Drone.
Micro Video Drone descends too fast	Control the THROTTLE CONTROL STICK slower and smoother. Recharge the Micro Video Drone.
Loss of Micro Video Drone control	Keep the Micro Video Drone within 250 feet of the controller.

## CARE AND MAINTENANCE

- Always remove the batteries from the controller when it will not be used for an extended period of time.
- To clean, gently wipe the Micro Video Drone and controller with a clean damp cloth.
- Parental guidance recommended when installing or replacing the batteries.

## MICRO VIDEO DRONE SPECIFICATIONS

Li-Poly Rechargeable Battery.....	3.7V, 140 mAh
Battery Life.....	Approx. 5-6 min
Charging Time .....	Approx. 40 min
Range .....	250 feet
Radio Frequency.....	2.4 Ghz
Weight .....	3.8 oz (107.7g)
Dimensions.....	2.3 x 2.3 in (58.4 x 58.4 mm)

microSD a trademark of SD-3C, LLC.  
© Brookstone 2016

## ONE (1) YEAR LIMITED WARRANTY

Brookstone® warrants this product against defects in materials and/or workmanship under normal use for a period of ONE (1) YEAR from the date of purchase by the original purchaser ("Warranty Period"). If a defect arises and a valid claim is received within the Warranty Period, at its option, Brookstone will either 1) repair the defect at no charge, using new or refurbished replacement parts, or 2) replace the product with a new product that is at least functionally equivalent to the original product, or 3) provide a store credit in the amount of the purchase price of the original product. A replacement product or part, including a user-installable part installed in accordance with instructions provided by Brookstone, assumes the remaining warranty of the original product. When a product or part is exchanged, any replacement item becomes your property and the replaced item becomes Brookstone's property. When a store credit is given, the original product must be returned to Brookstone and becomes Brookstone's property.

**Obtaining Service:** To obtain warranty service, call Brookstone Limited Warranty Service at 1-800-292-9819. Please be prepared to describe the product that needs service and the nature of the problem. A purchase receipt is required. All repairs and replacements must be authorized in advance. Service options, parts availability and response times will vary. You are responsible for delivery and the cost of delivery of the product or any parts to the authorized service center for replacement, per our instructions.

**Limits and Exclusions:** Coverage under this Limited Warranty is limited to the United States of America, including the District of Columbia and the U.S. Territories of Guam, Puerto Rico, and the U.S. Virgin Islands. This Limited Warranty applies only to products manufactured for Brookstone that can be identified by the "Brookstone" trademark, trade name, or logo affixed to them or their packaging. The Limited Warranty does not apply to any non-Brookstone products. Manufacturers or suppliers other than Brookstone may provide their own warranties to the purchaser, but Brookstone, in so far as permitted by law, provides these products "as is."

This warranty does not apply to: a) damage caused by failure to follow instructions relating to product's use or the installation of components; b) damage caused by accident, abuse, misuse, fire, floods, earthquake or other external causes; c) damage caused by service performed by anyone who is not a representative of Brookstone; d) accessories used in conjunction with a covered product; e) a product or part that has been modified to alter functionality or capability; f) items intended to be periodically replaced by the purchaser during the normal life of the product including, without limitation, batteries or light bulbs; g) any product sold "as is" including, without limitation, floor demonstration models and refurbished items; or h) a product that is used commercially or for a commercial purpose.

**BROOKSTONE SHALL NOT BE LIABLE FOR INCIDENTAL OR CONSEQUENTIAL DAMAGES RESULTING FROM THE USE OF THIS PRODUCT, OR ARISING OUT OF ANY BREACH OF THIS WARRANTY. TO THE EXTENT PERMITTED BY APPLICABLE LAW, BROOKSTONE DISCLAIMS ANY AND ALL STATUTORY OR IMPLIED WARRANTIES, INCLUDING, WITHOUT LIMITATION, WARRANTIES OF MERCHANTABILITY, FITNESS FOR A PARTICULAR PURPOSE AND WARRANTIES AGAINST HIDDEN OR LATENT DEFECTS. IF BROOKSTONE CANNOT LAWFULLY DISCLAIM STATUTORY OR IMPLIED WARRANTIES, THEN TO THE EXTENT PERMITTED BY LAW, ALL SUCH WARRANTIES SHALL BE LIMITED IN DURATION TO THE DURATION OF THIS EXPRESS WARRANTY.**

Some states disallow the exclusion or limitation of incidental or consequential damages or how long an implied warranty lasts, so the above exclusions or limitations may not apply to you. This warranty gives you specific legal rights and you may also have other rights, which vary from state to state.



Find thousands more  
great ideas online

**Brookstone®**

317918 317919

Merrimack, New Hampshire, USA 03054 • 800-846-3000 • [Brookstone.com](http://Brookstone.com)