

FCC Part 15 C Notice

CAUTION: Changes or modifications not expressly approved by the party responsible for compliance could void the user's authority to operate the equipment.

NOTE: This equipment has been tested and found to comply with the limits for a Class B digital device, pursuant to Part 15 of the FCC Rules. These limits are designed to provide reasonable protection against harmful interference in a residential installation. This equipment generates, uses and can radiate radio frequency energy and, if not installed and used in accordance with the instructions, may cause harmful interference to radio communications. However, there is no guarantee that interference will not occur in a particular installation. If this equipment does cause harmful interference to radio or television reception, which can be determined by turning the equipment off and on, the user is encouraged to try to correct the interference by one or more of the following measures:

- Reorient or relocate the receiving antenna.
- Increase the separation between the equipment and receiver.
- Connect the equipment into an outlet on a circuit different from that to which the receiver is connected.
- Consult the dealer or experienced radio/TV technician for help.

This device complies with Part 15 of the FCC Rules. Operation is subject to the following two conditions :

- (1) This device may not cause harmful interference, and
 - (2) this device must accept any interference received, including interference that may cause undesired operation.
- 3) This device must be installed to provide a separation distance of at least 20 cm from all persons.

INDUSTRY CANADA NOTICE: CANADA ONLY.

This device complies with Industry Canada licence-exempt RSS standard(s). Operation is subject to the following two conditions: (1) this device may not cause interference, and (2) this device must accept any interference, including interference that may cause undesired operation of the device.

Le présent appareil est conforme aux CNR d'Industrie Canada applicables aux appareils radio exempts de licence. L'exploitation est autorisée aux deux conditions suivantes : (1) l'appareil ne doit pas produire de brouillage, et (2) l'utilisateur de l'appareil doit accepter tout brouillage radioélectrique subi, même si le brouillage est susceptible d'en compromettre le fonctionnement.

WEEE Directive & Product Disposal



At the end of its serviceable life, this product should not be treated as household or general waste. It should be handed over to the applicable collection point for the recycling of electrical and electronics equipment, or returned to the supplier for disposal.

Internal/Supplied Batteries

This symbol on the battery indicates that the battery is to be collected separately. This battery is designed for separate collection at an appropriate collection point.



Conforms to safety requirements of FCC.

©2016 Rooftop Brands™ All rights reserved

Tel: + (1) 949-566-9573 • www.propelrc.com

Made in China

SPYDER XL™

Hybrid Stunt Drone with HD camera and Altitude Stabilization Technology



INSTRUCTION BOOKLET

WARNING: Never leave product charging unattended for extended periods of time. Always disconnect the battery from charger immediately after the battery is fully charged. Please refer to enclosed safety instructions.

PACKAGE CONTAINS:

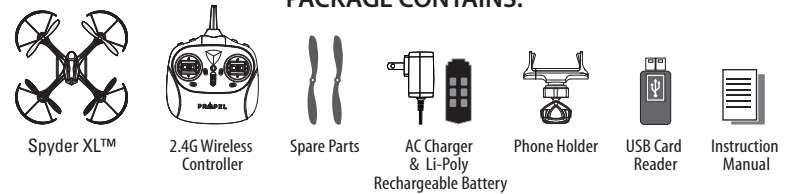

Colors and styles may slightly vary.

TABLE OF CONTENTS

Features	2
Remote Control Battery Installation	2
Charging the Spyder XL™'s Li-Poly Battery	2
Spyder XL™ Battery Installation	2
Spyder XL™ Diagram	3
Remote Control Diagram	3
Flight Preparation	4
Syncing Your Spyder XL™	4
Now You Are Ready To Fly	5
Recognizing The Front & Back Of The Spyder XL™	5
How to Start/Stop Rotors	5
Speed Select Button	5
Auto Land /Take Off Button	5
3 Channel VS 4 Channel Flying	6
3 Channel Flight Control	6
4 Channel Flight Control	7
Flight Practice	7
Adjusting The Trim	8
Calibrating The Spyder XL™	9
How To Perform 360° Stunt Rolls	10
Using Your On-Board Camera and Video Recorder	11
Testing /trouble Shooting The Camera Before Flight	12
Removing Your Micro SD Card	12
Downloading and Clearing Space on Your Micro SD Card	12
Troubleshooting Your Spyder XL™	13
Replacing The Propeller Blades	13
Warnings	14
Battery Warnings	14
Care and Maintenance	14
FCC Information	15

Thank you for purchasing the Spyder XL™ 2.4 Ghz Quadcopter. Please read this instruction booklet as it contains valuable information on how to properly fly and care for your Spyder XL™.

FEATURES

- Wide range digital radio allows flight range up to 500 feet!
- Six axis gyro for extremely stable flight and maneuverability
- Switch-blade technology allows you to operate in 3ch. Or 4ch. Modes for beginner to advanced pilots.
- Push button 360° aerial stunts
- On-board camera records high-definition videos and still photos(1280x720 pixel, 30 frames per second)
- Air pressure sensors lock flight altitude for stable video footage
- Automatically lands with the push of a button
- Additional replacement parts included

REMOTE CONTROL BATTERY INSTALLATION

1. Slide off the battery cover from the back of the controller.
2. Install 4 fresh "AA" alkaline batteries into the controller as shown in diagram A. Replace the battery cover.
3. Turn over the controller and turn the on/off switch to the on position. If the power indicator turns on you have installed your batteries properly.

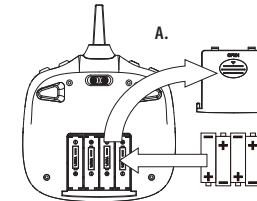

CHARGING THE SPYDER XL™'S LI-POLY BATTERY

1. Connect the battery to the battery charger as shown (see diagram B).
2. Next, Plug the AC adaptor into a standard wall socket.
CAUTION: improper connection may damage the battery.
Note: The battery charger has a RED LED indicator light to indicate it is charging.
3. When the battery is fully charged the charging indicator light will change to green.
4. Average charging time is approximately 80-100 minutes. A fully charged drone can fly for approximately 10 minutes depending on environment and user input.

NOTE: You may purchase additional batteries and chargers at www.propelrc.com

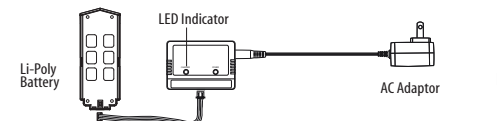

IMPORTANT: ALWAYS REMEMBER TO DISCONNECT YOUR BATTERY CHARGER WHEN NOT IN USE!

SPYDER XL™ BATTERY INSTALLATION

1. Slide the fully charged battery into the Spyder XL™'s battery compartment (see diagram C). The battery is designed to only fit in the compartment one-way, with the guide rail on the bottom of battery facing downward.
2. Push the battery all the way in and you will hear a click, the drone's LED lights will light up and begin flashing when you have installed the battery correctly.
NOTE: The Spyder XL™ has no On/Off switch. The drone automatically turns on when the battery is installed.
3. Removing the battery: On the underside of the drone body you will see a small battery eject lever. Using your finger nail pull the lever up and the battery will eject about 0.5-1cm (see diagram D). Lastly, using your thumb and forefinger gently pull out the battery.

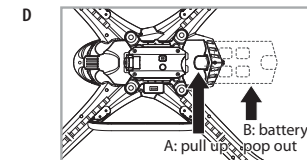
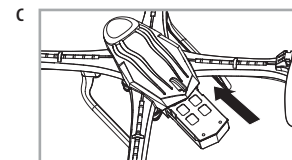

SPYDER XL™ DIAGRAM

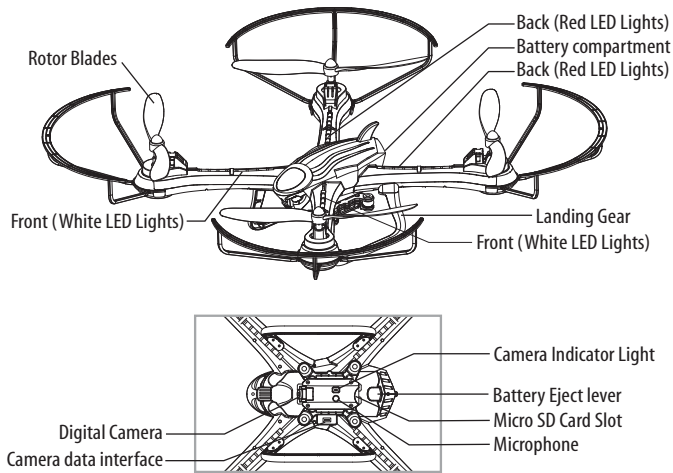

CONTROLLER DIAGRAM

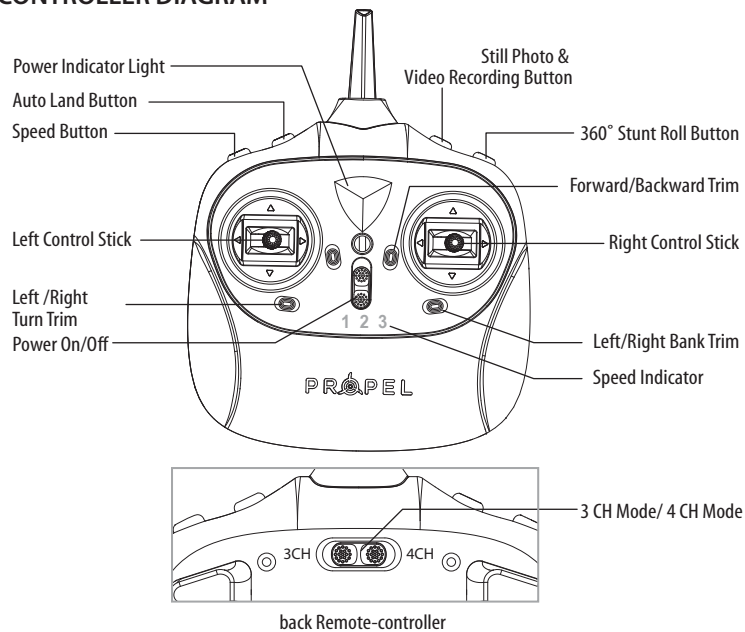

WARNING

DO NOT FLY YOUR SPYDER XL™ IN FOUL WEATHER!



FLIGHT PREPARATION

- Verify that there are 4 "AA" batteries inside the remote control unit and the Spyder XL™ has been fully charged.
- Make sure to be in a large open space preferably a field or a park with an open radius of at least 200 feet.
- Make sure to start your drone on a clean flat level surface before take-off.
- **IMPORTANT! Until you have experience in flying your Spyder XL™, it is not advised to use in any rate of wind. Wait until a zero wind day or extremely light wind when learning how to fly.**

SYNCING YOUR SPYDER XL™

Important! When syncing your Spyder XL™ with the controller always make sure that the drone is on a flat level surface and that your digital trim settings are in the center position. This insures that the 6 Axis gyro is properly programmed to respond to your trim settings. Your Spyder XL™ utilizes an automatic 2.4G channel selection system that allows up to 8 people to fly side by side in the same wireless range with no interference.

1. Before starting, make sure that the power switch on your controller is off and the battery is removed from the Spyder XL™. Make sure that there are no other 2.4G devices in the area.
2. Insert the battery into the Spyder XL™ and set it down on any flat surface. The red and white LED lights on top of the drone should begin to flash repeatedly.
3. Quickly turn ON the remote and you will notice that the top red LED light on the face of the controller should also be flashing.
4. Push the left control stick all the way up until it stops and then pull it back all the way down to the bottom (see illustration below). When pulling the stick down to the bottom you should hear a high-pitched beep and the lights on both the drone and the controller should stop flashing and become solid. If the lights on both the drone and the controller have stopped flashing and become solid you have successfully synced your Spyder XL™ and are ready to fly. If the lights on the controller or the drone are still flashing repeat steps 1-4 again.

- **TIP 1: try not to leave too much time between putting your battery into the drone and turning on the controller or your syncing window will time-out.**
- **TIP 2: Syncing your drone indoors or in the shade will make it easier to see the LED light indicators on both the controller and the drone.**

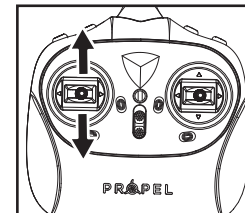

Move the control stick all the way up and all the way down you should hear a beep

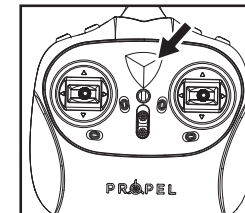

The flashing red LED light will become solid when you are synced

NOW YOU ARE READY TO FLY!

If you have successfully synced your Spyder XL™ to your controller as explained on page 4 you are now ready to fly. Before beginning to fly your drone you should familiarize yourself with how to start and stop the rotors, how to use your auto land feature and how the controls work so please carefully read and familiarize yourself with various control features explain in the next two pages. Once again as a beginner pilot you should learn how to control your drone in a large open field or park on a day with zero or very light wind. Do not try to fly your Spyder XL™ too high until you become a more experience pilot.

RECOGNIZING THE FRONT & BACK OF THE SPYDER XL™

Even though the Spyder XL™ has four rotors there is still a front or "forward" facing direction and "back" or backwards facing direction. The forward Front and forward facing direction of the Spyder XL™ is the side with two EYES (see diagram E). The rear and back of the Quadcopter is the side with battery compartment (see diagram E).

NOTE: The front of the Quadcopter also displays WHITE LED light and the back of the Quadcopter displays RED LED lights.

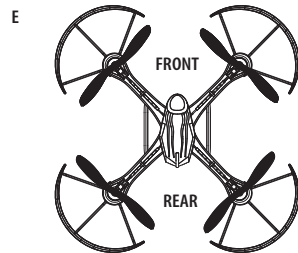

HOW TO START/STOP ROTORS

Make sure you have properly synced the Spyder XL™ and the power is on.

- To start and stop the rotors simply move the two control sticks either simultaneously down and to the inside or down and to the outside corners and hold for one second (see illustration below).

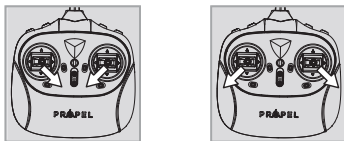

Note: Either position will both start and stop the rotors so use the position you are most comfortable with.

- Once the rotors begin to spin release the control sticks and they will return to the center position. Now you are ready for take-off.

SPEED SELECT BUTTON

The Spyder XL™ has 3 speed settings; 1 (SLOW), 2 (MEDIUM) and 3 (HIGH). The Default setting when you first turn on your Spyder XL™ is the 1 (SLOW) speed mode. To increase the speed simply trigger the Speed setting button (see remote diagram on pg 3) you will hear a beep and the speed setting indicator on the face of the controller will show you what speed setting you are on. Speed settings can be set before flight or during the flight.

AUTO LAND BUTTON /AUTO TAKE OFF

The Spyder XL™ has an auto land and auto take off feature which allows you to land or take off automatically. Simply press the Auto Land Button and your Spyder XL™ will begin land or take off by itself.

Note: you can still control the direction while auto landing or taking off to avoid obstacles

3 CHANNEL VS 4 CHANNEL FLYING

Propels unique "switch-blade" technology allows you to choose between 3ch or 4ch flight control modes. Most people with no experience in flying multi copters may find 3ch easier to learn at first as controls are set up to simply move forward, back, turn left and turn right. 4channel flying gives the operator ultimate control by adding two more dimension of flight banking left and banking right.

To change to 3 Channel mode:

Switch the 3/4 CH. button to left side on the back of controller (see remote diagram on pg 3), you will hear 3 "beeps" indicating the Spyder XL™ now is set to 3 CH. mode.

To change to 4 Channel mode:

Switch the 3/4 CH. button to right side on the back of controller (see remote diagram on pg 3), you will hear 4 "beeps" indicating the Spyder XL™ now is set to 4 CH. mode.

3 CHANNEL FLIGHT CONTROL

Below is a list of basic flight functions for your long-range remote to control the Spyder XL™. While learning to fly your Spyder XL™ it is best to start in a large space with the drone facing away from you until you get used to the basic controls. As you master flying your Spyder XL™ you can move to more advanced maneuvering techniques. Practice makes perfect! When you have these basic steps down you can move to the next level.

Move the left Throttle stick up to increase the propeller speed and the Spyder XL™ will accelerate and ascend.

Move the left Throttle stick down to decrease the propeller speed and the Spyder XL™ will decelerate and descend (see diagram F).

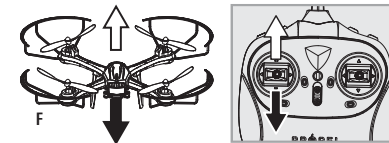

While in the air, move the right Direction Stick up and the Spyder XL™ will move forward.

Move the right Direction Control down and the Spyder XL™ will move backward (see diagram G).

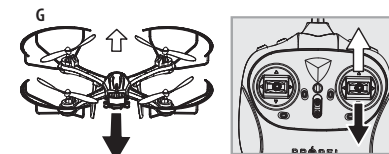

While in the air, move the right Direction Control left and the Spyder XL™ will spin to the left.

Move the right Direction Control right and the Spyder XL™ will spin to the right (see diagram H).

