

FCC Part 15 B Notice

CAUTION: Changes or modifications not expressly approved by the party responsible for compliance could void the user's authority to operate the equipment.

NOTE: This equipment has been tested and found to comply with the limits for a Class B digital device, pursuant to Part 15 of the FCC Rules. These limits are designed to provide reasonable protection against harmful interference in a residential installation. This equipment generates, uses and can radiate radio frequency energy and, if not installed and used in accordance with the instructions, may cause harmful interference to radio communications. However, there is no guarantee that interference will not occur in a particular installation. If this equipment does cause harmful interference to radio or television reception, which can be determined by turning the equipment off and on, the user is encouraged to try to correct the interference by one or more of the following measures:

- Reorient or relocate the receiving antenna.
- Increase the separation between the equipment and receiver.
- Connect the equipment into an outlet on a circuit different from that to which the receiver is connected.
- Consult the dealer or experienced radio/TV technician for help.

This device complies with Part 15 of the FCC Rules. Operation is subject to the following two conditions :

- (1) This device may not cause harmful interference, and
- (2) this device must accept any interference received, including interference that may cause undesired operation.

ZEPHYRUS™

2.4GHz indoor & outdoor quadrocopter



INSTRUCTION BOOKLET

WARNING: Never leave product charging unattended for extended periods of time. Always disconnect Quadrocopter from charger immediately after the Quadrocopter is fully charged. Please refer to enclosed safety instructions.

PACKAGE CONTAINS:

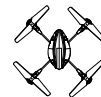

Quadrocopter



2.4G Wireless Controller



Instruction Booklet

Colors and styles may slightly vary.



Conforms to safety requirements of ASTM, CPSIA and FCC.

©2013 Rooftop Brands™ All rights reserved
Tel: + (1) 949-566-9573 • www.propelrc.com

Made in China

TABLE OF CONTENTS

Features.....	2
Remote Battery Installation.....	2
Charging the Quadcopter Battery.....	2
Quadcopter Battery Installation.....	2
Quadcopter Diagram, Remote Diagram.....	3
Preparing For Flight.....	4
Syncing Your Quadcopter.....	4
Flying Tips.....	4
Turn Left / Right Trim.....	5
Forward / Backward Trim.....	5
Banking Left / Right Trim.....	6
Throttle Sensitivity Trim.....	6
Speed Select button.....	6
Flight Control.....	7
360° Stunt rolls.....	8
Troubleshooting.....	9
Battery Warnings, Care and Maintenance.....	9
FCC Part 15 B Notice.....	11

FEATURES

- Built in 3 axis gyroscopic chip keeps the Zephyrus extremely stable in all conditions.
- 4 channel flight controls allow for incredible manoeuvrability including 360° aerial stunts!
- 5 speed settings for beginner to advanced quadcopter pilots.
- LED directional lights makes the Zephyrus easy to follow.
- Replaceable Li-poly battery included.
- 200 foot range.

REMOTE CONTROL BATTERY INSTALLATION

1. Slide the battery cover off of the remote control.
2. Install 6“AA” alkaline batteries into the battery pack and then install the pack in the controller as shown in the diagram.
3. Replace the battery cover.

CHARGING THE BATTERY

1. Connect the battery to the adaptor as shown (see illustration A).
2. Plug the charger into a wall outlet. The charger's charging indicator lights red to show that charging is in progress.
3. Average charging time is approximately 90-120 minutes. The Quadcopter operates for approximately 6-8 minutes on full charge.
4. The charging indicator turns off when the battery is fully charged.

Note: the adaptor should be periodically examined for conditions that may result in the risk of fire, electric shock, or injury to persons and that, in an event of such conditions, the adaptor should not be used until properly repaired.

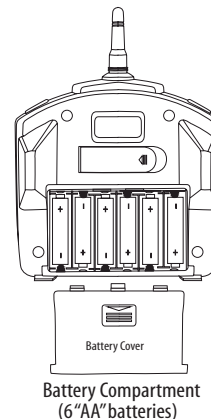
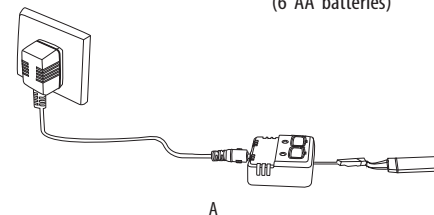

QUADROPTER BATTERY INSTALLATION

1. Snap off the cover on the bottom of the quadcopter (see diagram B).
2. Slide the battery in and connect the power cord as shown on diagram C.
3. Replace the bottom cover.

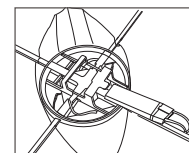
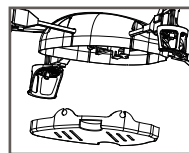

Thank you for purchasing the Zephyrus™ 2.4 G Indoor & Outdoor Quadcopter. Please read this instruction booklet as it contains valuable information on how to properly fly and care for your Quadcopter.

IMPORTANT: ALWAYS DISCONNECT WALL CHARGER AFTER CHARGING. NEVER LEAVE CHARGER CONNECTED TO QUADROPTER BATTERY OVERNIGHT OR FOR EXTENDED PERIODS OF TIME.

QUADROCOPTER DIAGRAM

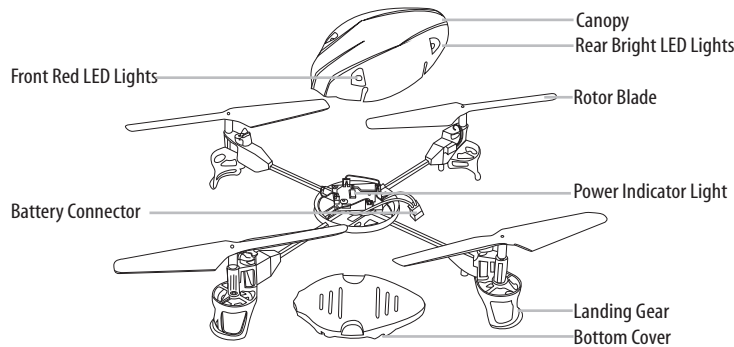

REMOTE DIAGRAM

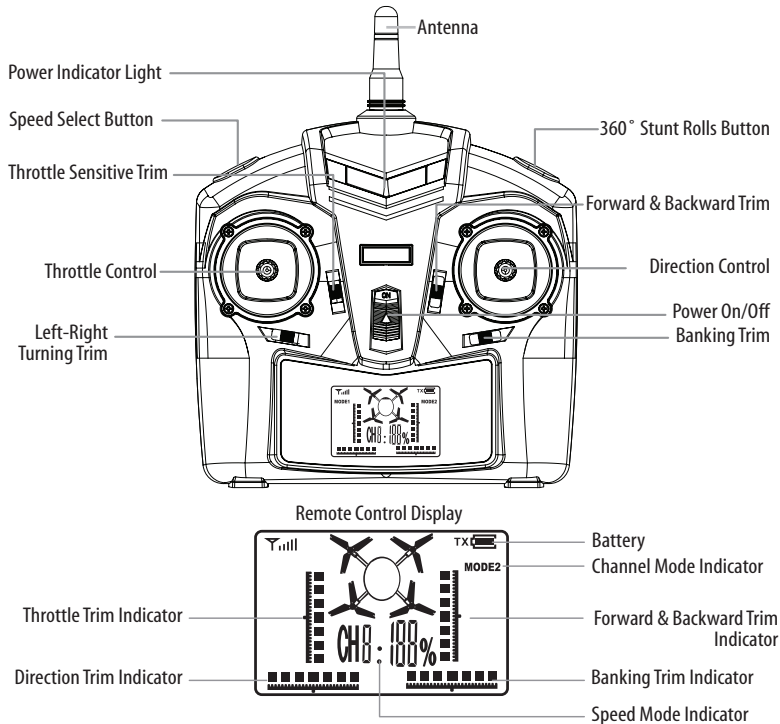

WARNING

DO NOT FLY YOUR ZEPHYRUS IN FOUL WEATHER!



PREPARING FOR FLIGHT

- Verify that there are 6 "AA" batteries inside the remote control unit and the Quadcopter has been fully charged.
 - Make sure your Quadcopter and controller are turned on.
 - Make sure to be in a large space with an open radius of at least 50 feet.
 - Make sure the empty space has no obstacles and river. Set your Quadcopter on a clean flat surface before take-off.
- DO NOT ATTEMPT TO FLY YOUR ZEPHYRUS IF THERE IS RAIN, SNOW, HEAVY WINDS, THUNDER OR LIGHTNING OUTDOORS. IT COULD DAMAGE YOUR PRODUCT AND POSSIBLY EVEN CAUSE BODILY HARM.**

SYNCING YOUR QUADROCOPTER

Your Zephyrus™ utilizes an automatic 2.4G channel selection system that allows up to 8 people to fly side by side in the same wireless range.

For One Person Play:

1. Before starting, make sure that the power on both your controller and Quadcopter are in the OFF position. Make sure that there are no other 2.4G devices in the area as well.
2. Turn ON the Quadcopter and set it down on a flat surface. The red LED indicators inside the Quadcopter body should flash.
3. ON the remote, pull the throttle all the way down, then turn ON your remote. The remote will beep in 3-5 seconds. When you hear a long beep, the red LED light should turn on. This indicates that your Quadcopter and remote have successfully synced. Should this not happen, repeat all steps again.

For Multi Person Play:

4. Before starting, make sure that the power on all Quadcopters and Controllers are in the OFF position. Make sure that there are no other 2.4G devices in the area as well.
5. Each person will have to sync their Quadcopter individually at a different time to avoid interference. Follow steps 1 to 3 above making sure to keep away from other people while also making sure that no one else is syncing at the same time.
6. After syncing a player's Quadcopter, it should be left ON until all players have synced their Quadcopters.
7. Should there be a mistake/interference, all players must turn off their controllers and Quadcopters and start the process all over again.

FLYING TIPS

- It is recommended that you operate the Quadcopter in a wide space. The ideal space should have a 200 foot radius.
- Parental guidance or adult supervision is suggested at all times.
- If you are flying the Quadcopter with others, make sure all spectators are behind you.
- For best performance, it is recommended that you operate the Quadcopter in zero wind conditions. Wind can greatly affect the performance of the Quadcopter.

UNDERSTANDING TRIM ADJUSTMENTS

Turn Left/Right Trim

- If your Quadcopter nose rotates to the left or right uncontrollably, you may need to utilize the DIRECTION TRIM buttons.
- If your Quadcopter over rotates CLOCKWISE (to the right), push and release the DIRECTION TRIM button repeatedly to left side until the turning stops and proper flight is maintained.
- If your Quadcopter over rotates COUNTER-CLOCKWISE (to the left), push and release the DIRECTION TRIM button to right side in the same manner until the problem is resolved.
- From time to time you may have to adjust the DIRECTION TRIM to left and right to ensure the Quadcopter will fly straight and respond accurately to control commands.

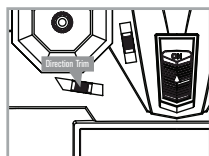

Direction Trim Controls

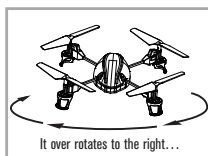

 Push to left

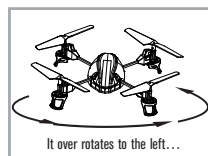

 Push to right

Forward/Backward Trim

- If your Quadcopter is moving forwards or backwards automatically, you may need to adjust the FORWARD/BACKWARD TRIM buttons.
- If your Quadcopter flies forward, push and release the FORWARD/BACKWARD TRIM button back/down repeatedly until the moving stops and proper flight is maintained.
- If your Quadcopter flies backwards, push and release the FORWARD/BACKWARD TRIM button forward/up in the same manner until the problem is resolved.
- From time to time you may have to adjust the FORWARD/BACKWARD TRIM to ensure the Quadcopter will hover in mid-air and respond accurately to your commands.

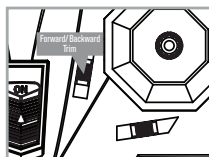

Forward/Backward Trim Controls

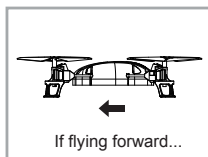

 Push down to go backward

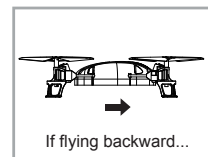

 Push up to go forward

Banking Left/Right Trim

- If your Quadcopter is not steadily hovering and is banking to the left or right automatically, you may need to adjust the BANKING TRIM buttons.
- If your Quadcopter banks to the left, push and release the BANKING TRIM button repeatedly to the right until the banking stops and proper flight is maintained.
- If your Quadcopter banks to the right, push and release the BANKING TRIM button to the left in the same manner until the problem is resolved.
- From time to time you may have to adjust the BANKING TRIM to left/right to ensure the Quadcopter will steadily hover in mid-air and respond accurately to your commands.

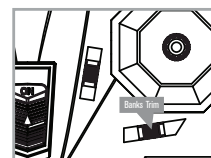

4 CH Left/Right Banking Controls

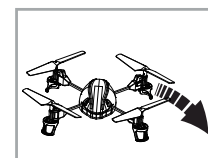

 Push to right to increase right banking sensitivity

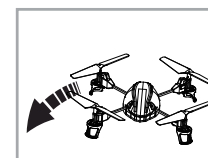

 Push to left to increase left banking sensitivity

Throttle Sensitivity Trim

- If you find the throttle is too sensitive when you fly the Quadcopter, you may need to utilize the Throttle sensitivity trim.
- Push the Throttle sensitivity trim button back to lower the sensitivity of the throttle. Push the Throttle sensitivity trim button forward to increase the sensitivity of the throttle. The middle position is recommended for beginners.

NOTE: The use of the Trim buttons are accompanied with a Beep tone. A single long Beep indicates the product is center trimmed. Continuous long Beeps indicate the product is trimmed to the maximum on a particular side.

SPEED SELECT BUTTON

The Quadcopter has 5 speed settings, the initial setting is 20%, Press the SPEED SELECT button on the top left of the remote control and your Quadcopter will change to 40%, 60%, 80% and 100% speed.

FLIGHT CONTROL

Below is a list of basic flight functions for your long-range remote control Quadcopter. While learning to fly your Quadcopter it is best to start with a large space until you get used to the basic controls. As you master flying your Quadcopter you can move to more advanced maneuvering techniques. Practice makes perfect! When you have these basic steps down you can move to the next level.

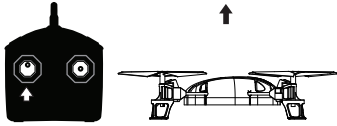

Move the Throttle up to increase the speed and the Quadcopter will rise up.



Move the Throttle down to decrease the speed and the Quadcopter will descend.

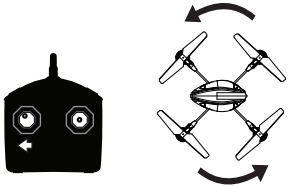

Move the Throttle left and the Quadcopter will turn left.

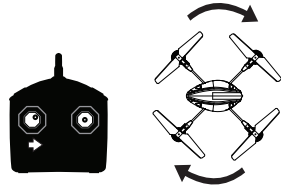

Move the Throttle right and the Quadcopter will turn right.

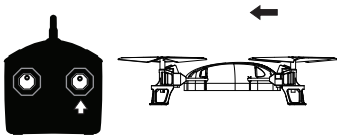

Move the Direction Control up and the Quadcopter will move forward.

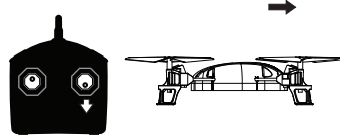

Move the Direction Control down and the Quadcopter will move backward.

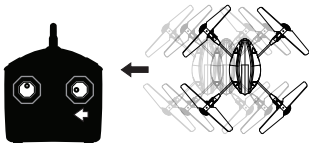

Move the Direction Control left and the Quadcopter will bank to the left.

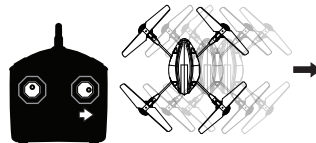

Move the Direction Control right and the Quadcopter will bank to the right.

360° STUNT ROLLS

The 360° Stunt Rolls will only work when the speed is set to 80% or 100%. After setting the speed at 80% or 100%, press the Stunt Rolls button, the Quadcopter will do a 360° stunt roll in mid-air.

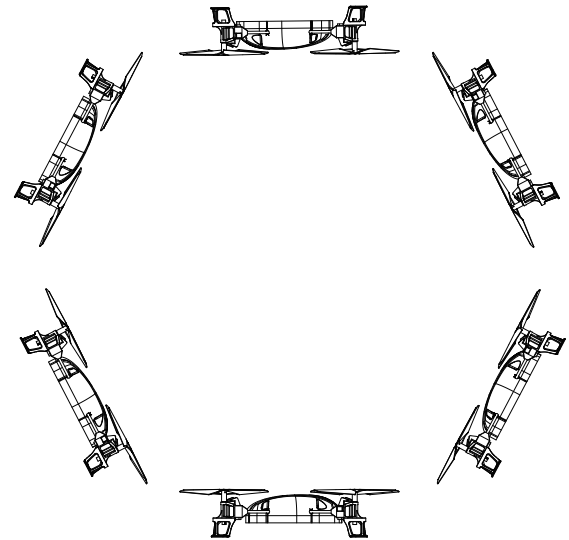

TROUBLESHOOTING

Before sending your Quadcopter in for repair, please check for a solution below.

Problem	Possible Cause(s)	Solution
Controller not responding	Weak Batteries; No Batteries	Install new batteries in controller
Quadcopter does not respond properly to the controller	Controller is switched OFF Low Battery power in Quadcopter or Controller Quadcopter and Controller not properly synced	Switch ON Controller Ensure Quadcopter battery is fully charged and replace controller batteries Refer to the SYNCING YOUR QUADROPTER section
Quadcopter loses connection with controller	Quadcopter Out of Range Low Battery power in Quadcopter or Controller	Fly Quadcopter closer and within maximum range Ensure Quadcopter battery is fully charged and replace controller batteries
Quadcopter does not fly well	Quadcopter not Trimmed Blade, Rotor or other parts may be damaged Flying in Inclement Weather	Refer to Understanding Trim Adjustments Check and repair/replace damaged parts Stop flying and wait until the weather improves

QUADROPTER WARNING:

The Quadcopter is designed for INDOOR & OUTDOOR USE. The Quadcopter blades revolve at high speeds and can cause damage to the user, spectators and animals. Stand away from the Quadcopter to reduce the risk of getting into the flight path. Warn spectators that you will be flying your Quadcopter so that they are aware of its position. Before flight, inspect the rotor blades to make certain that the blades are securely fastened to the Quadcopter.

WARNING:

- Choking/Cutting Hazard. Small Parts/Sharp Rotor Blades.
- Keep hands, hair and loose clothing away from the propeller when the power switch is turned to the ON position.
- Turn off the transmitter and Quadcopter power switches when not in use.
- The included charger is built specifically for the Quadcopters Li-Poly battery. Do not use it to charge any other battery.
- New alkaline batteries are recommended for maximum performance.
- Parental supervision recommended when flying Quadcopter.

BATTERY WARNINGS

RECHARGEABLE BATTERY:

This Quadcopter uses a Li-Poly rechargeable battery. If battery no longer stays charged, dispose of battery properly according to local disposal requirements.

CONTROLLER BATTERIES:

- Remote control requires 6 "AA" batteries (not included). Please read the important battery safety warning below.
- Do not mix alkaline, standard (carbon-zinc) and rechargeable batteries (Nickel Metal Hydride).
- Do not mix old and new batteries.
- Non-rechargeable batteries are not to be recharged.
- Rechargeable batteries are to be removed from the item before being charged (if removable).
- Rechargeable batteries are only to be charged under adult supervision.
- Exhausted batteries should be removed immediately and must be recycled or disposed of properly according to state or local government ordinances and regulations.
- The supply terminals are not to be short-circuited.
- Only batteries of the same or equivalent type as recommended are to be used.
- Batteries are to be inserted with the correct polarity (see inside booklet for diagram).
- Do not dispose batteries in a fire - batteries may leak or explode.

CARE AND MAINTENANCE

- Always remove the batteries from the wireless infrared remote control when it is not being used for an extended period of time.
- To clean, gently wipe the remote control and Quadcopter with a clean damp cloth.
- Keep the toy away from direct heat or sunlight.
- Do not submerge the toy into water. This can damage the unit beyond repair.
- Parental guidance recommended when installing or replacing the batteries.