

Trim size 4.5 x 6.875 in.
Spread size 9 x 6.875 in.

PROPEL

PROPEL

FCC Part 15 C Notice

CAUTION: Changes or modifications not expressly approved by the party responsible for compliance could void the user's authority to operate the equipment.

NOTE: This equipment has been tested and found to comply with the limits for a Class B digital device, pursuant to Part 15 of the FCC Rules. These limits are designed to provide reasonable protection against harmful interference in a residential installation. This equipment generates, uses and can radiate radio frequency energy and, if not installed and used in accordance with the instructions, may cause harmful interference to radio communications. However, there is no guarantee that interference will not occur in a particular installation. If this equipment does cause harmful interference to radio or television reception, which can be determined by turning the equipment off and on, the user is encouraged to try to correct the interference by one or more of the following measures:

- Reorient or relocate the receiving antenna.
- Increase the separation between the equipment and receiver.
- Connect the equipment into an outlet on a circuit different from that to which the receiver is connected.
- Consult the dealer or experienced radio/TV technician for help.

This device complies with Part 15 of the FCC Rules. Operation is subject to the following two conditions :

- (1) This device may not cause harmful interference, and
- (2) this device must accept any interference received, including interference that may cause undesired operation.

INDUSTRY CANADA NOTICE: CANADA ONLY.

This device complies with Industry Canada licence-exempt RSS standard(s). Operation is subject to the following two conditions: (1) this device may not cause interference, and (2) this device must accept any interference, including interference that may cause undesired operation of the device.

Le présent appareil est conforme aux CNR d'Industrie Canada applicables aux appareils radio exempts de licence. L'exploitation est autorisée aux deux conditions suivantes : (1) l'appareil ne doit pas produire de brouillage, et (2) l'utilisateur de l'appareil doit accepter tout brouillage radioélectrique subi, même si le brouillage est susceptible d'en compromettre le fonctionnement.



Conforms to safety requirements of ASTM, CPSIA and FCC.

©2016 Rooftop Brands™ All rights reserved
Tel: + (1) 949-566-9573 • www.propelrc.com

V2
Made in China

ATOM 1.0™ MICRO DRONE INDOOR / OUTDOOR WIRELESS QUADROPTER



INSTRUCTION BOOKLET

WARNING: Never leave product charging unattended for extended periods of time. Always disconnect the Atom 1.0™ from charger immediately after it is fully charged. Please refer to enclosed safety instructions.

PACKAGE CONTAINS:



Atom 1.0™



2.4G Wireless Controller



Spare Parts



USB charging cord



Instruction Manual

Colors and styles may slightly vary.



TABLE OF CONTENTS

Product Features	2
Remote Control Battery Installation	2
Charging Your Atom 1.0™ Battery	2
Atom 1.0™ Diagram	3
Remote Control Diagram	3
Synching Your Atom 1.0™	4
Flight Preperation	4
Flying Tips	4
Recognizing The Front & Back Of The Atom 1.0™	5
3/4 Channel Select	5
4 Channel Flight Controls (Advanced Flying)	5
3 Channel Flight Controls (Beginner Flying)	6
Switching To Medium & High Speed Mode	6
Understanding Trim Adjustments	7
Level Surface Gyro Calibration	7
Low Battery Warning	7
Performing A 360° Stunt Roll	8
Trouble Shooting	9
Replacing The Propeller Blades	9
Warnings	10
Battery Warnings	10
Care and Maintenance	10
FCC Information	11

Thank you for purchasing the Atom 1.0™ 2.4 Ghz Mini Quadcopter. Please read this instruction booklet as it contains valuable information on how to properly fly and care for your Atom 1.0™ Drone.

FEATURES

- Built-in 6axis gyro chip for extremely stable flight.
- 2.4 Ghz digital technology allows for flight range up to 100 feet.
- 4 channel flight controls allow for incredible maneuverability including 360° aerial stunts!
- Unique Switch-Blade technology allows you to operate in either 3ch or 4ch modes for beginner to advanced pilots

REMOTE CONTROL BATTERY INSTALLATION

1. Unscrew the battery cover from the back of the controller as shown in diagram A.
2. Install 2 "AAA" alkaline batteries into the controller as shown in diagram B.
3. Replace the battery cover.
4. Turn over the controller and turn the on/off switch to the on position the red LED will flash if batteries are installed correctly.

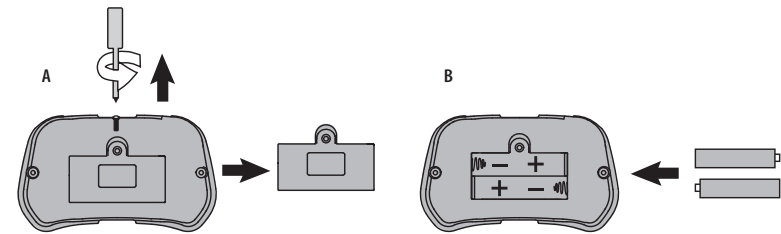

CHARGING YOUR ATOM 1.0™ BATTERY

1. Switch the quadcopter Off. Connect the power cable to the unit making sure the arrow side of the connector is on top side facing the top of the Atom 1.0™ (see diagrams C1 and C2).
CAUTION: The USB plug fits the charging socket only in one way. Do not force it. Improper connection will damage the Atom 1.0™.
2. Connect the USB end of the cable to your computers USB port (see diagram D).
3. The red LED on the USB plug lights up when charging is complete. Average charging time is 30 minutes.
Note: If the red LED lights up, either the charging is complete or the USB plug is not properly connected.
A full charge will allow for about 5 minutes of flight time depending on environment and user input.

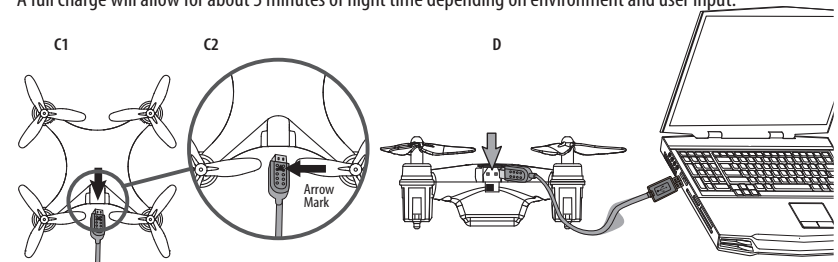

IMPORTANT: ALWAYS REMEMBER TO UNPLUG YOUR CHARGING CORD WHEN NOT IN USE!

ATOM 1.0™ DIAGRAM

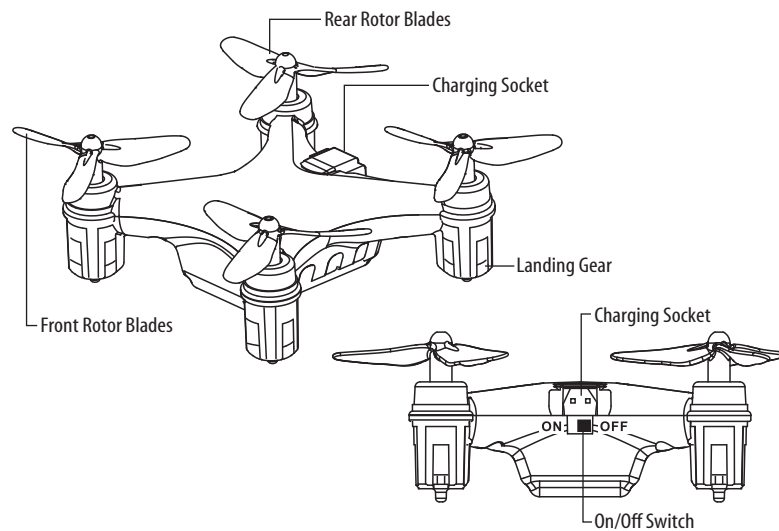

ATOM 1.0™ REMOTE DIAGRAM

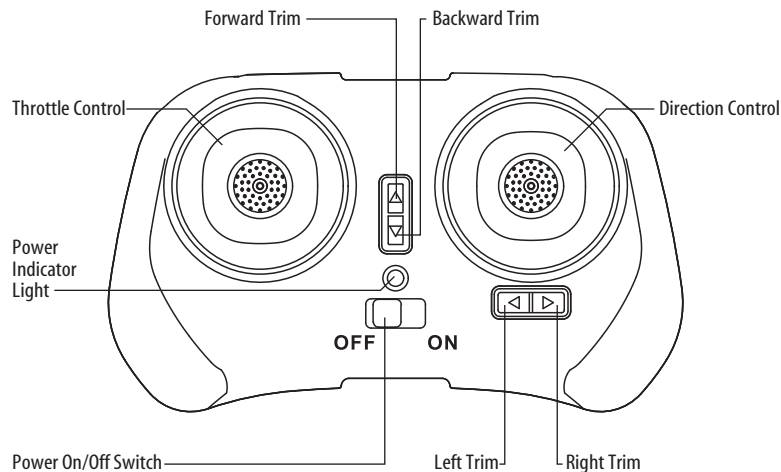

WARNING

DO NOT FLY YOUR ATOM 1.0™ IN FOUL WEATHER!



SYNCING YOUR ATOM 1.0™

Important! When syncing your Atom 1.0™ quadcopter with the controller always make sure that the quadcopter is on a flat level surface and that your digital trim settings are in the center position. This ensures that the 6 Axis gyro is properly programmed to mimic your trim settings.

Your Atom 1.0™ utilizes an automatic 2.4G channel selection system that allows up to 8 people to fly side by side in the same wireless range with no interference.

For One-Person Play:

1. Before starting, make sure that the power on both your controller and Atom 1.0™ are in the OFF position. Make sure that there are no other 2.4G devices in the area as well.
2. Turn ON the Atom 1.0™ and set it down on a flat surface. The LED indicator lights of the Atom 1.0™ should begin to flash rapidly.
3. Turn ON the remote, you will hear two short beeps. The Atom 1.0™'s LED lights should now flash slowly. Push the throttle on the left all the way forward (1 beep) and then pull the throttle all the way back. A 2nd beep will sound and the lights should turn to solid. This indicates your controller and the quadcopter are successfully synced. If not, repeat above steps.

For Multi Person Play:

4. Before starting, make sure that the power on all Atom 1.0™ drones and Controllers are in the OFF position. Make sure that there are no other 2.4G devices in the area.
5. Each person will have to sync their Atom 1.0™ individually at a different time to avoid interference. Follow steps 1 to 3 above making sure that no one else is syncing at the same time.
6. After syncing a player's Atom 1.0™, it should be left ON until all players have synced their Atom 1.0™ quadcopters.
7. Should there be a mistake or interference, all players must turn off their controllers and Atom 1.0™ quadcopters for up to 60 seconds and then begin the process again.

PREPARING FOR FLIGHT

- Verify that there are 2 "AAA" batteries inside the remote control unit and the Atom 1.0™ has been fully charged.
- Make sure your Atom 1.0™ and controller are both turned on.
- Make sure to be in a large space with an open radius of at least 50 feet.
- Make sure the empty space has no obstacles and water close by. Set your Atom 1.0™ on a clean flat surface before take-off.

DO NOT ATTEMPT TO FLY YOUR ATOM 1.0™ IF THERE IS RAIN, SNOW, HEAVY WINDS, THUNDER OR LIGHTNING OUTDOORS. IT COULD DAMAGE YOUR PRODUCT AND POSSIBLY EVEN CAUSE BODILY HARM.

FLYING TIPS

- It is recommended that you operate the Atom 1.0™ in a wide open space. The ideal space should have a 200 foot radius.
- Parental guidance or adult supervision is suggested at all times.
- If you are flying the Atom 1.0™ with others, make sure all spectators are behind you.
- For best performance, it is recommended that you operate the Atom 1.0™ in zero wind conditions, as wind can greatly affect the performance of the aircraft.

RECOGNIZING THE FRONT & BACK OF THE ATOM 1.0™

Even though the Atom 1.0™ has four rotors, there is still a "front" or forward facing direction and "back" or backwards facing direction. The front and forward facing direction of the Atom 1.0™ is the side with two gray propellers (see diagram E). The rear and backwards facing of the Quadcopter is the side with two black propellers (see diagram E).

NOTE: The front of the Quadcopter displays WHITE LED lights and the back of the Quadcopter displays RED LED lights.

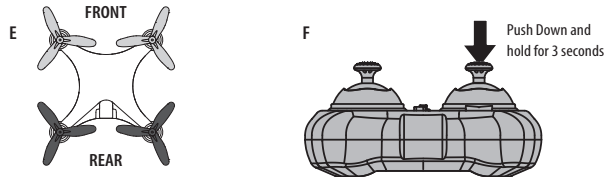

3/4 CHANNEL SELECT

Atom™ 1.0 allows you to control your micro drone in 3 channel mode (beginner) or 4 channel mode (advanced flying). The Atom™ 1.0 default setting is 4 Channel mode.

To change to 3 Channel mode:

After syncing your quadcopter, depress and hold the control stick on the right side straight down for 3 seconds, you will hear a long beep indicating the Atom™ 1.0 is now set to 3CH mode. (see diagram F).

To change back to 4 Channel mode:

Depress and hold the control stick on the right side straight down for 3 seconds again, you will hear a long beep indicating the Atom™ 1.0 is now set to 4CH mode. (see diagram F).

4 CHANNEL FLIGHT CONTROLS (ADVANCED FLYING)

Below is a list of basic flight functions for your long-range remote control Atom 1.0™. While learning to fly your Atom 1.0™ it is best to start in a large space until you get used to the basic controls. As you master flying your Atom 1.0™ you can move to more advanced maneuvering techniques. Practice makes perfect! When you have these basic steps down you can move to the next level.

Move the left Throttle stick upwards to increase the speed of the propellers and the Atom 1.0™ will accelerate upwards and ascend.

Move the left Throttle stick down to decrease the speed and the Atom 1.0™ will decelerate and descend (see diagram G).

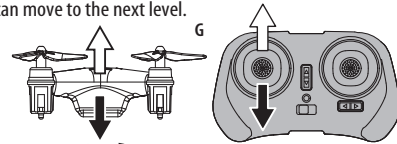

While in the air, move the left Throttle stick left and the Atom 1.0™ will rotate left.

Move the left Throttle stick right and the Atom 1.0™ will rotate right (see diagram H).

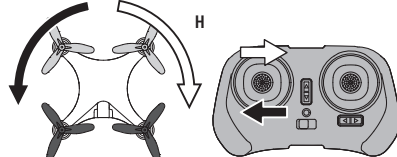

While in the air, move the right Direction Stick up and the Atom 1.0™ will move forward.

Move the right Direction Stick down and the Atom 1.0™ will move backward (see diagram I).

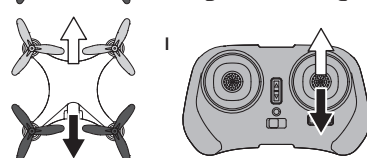

While in the air, move the right Direction Stick left and the Atom 1.0™ will bank to the left.

Move the right Direction Stick right and the Atom 1.0™ will bank to the right (see diagram J).

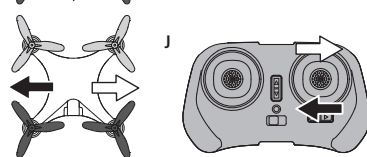

3 CHANNEL FLIGHT CONTROLS (BEGINNER FLYING)

Below is a list of basic flight functions for your long-range remote control Atom 1.0™. While learning to fly your Atom 1.0™ it is best to start in a large space until you get used to the basic controls. As you master flying your Atom 1.0™ you can move to more advanced maneuvering techniques. Practice makes perfect! When you have these basic steps down you can move to the next level.

Move the left Throttle stick upwards to increase the speed of the propellers and the Atom 1.0™ will accelerate upwards and ascend.

Move the left Throttle stick down to decrease the speed and the Atom 1.0™ will decelerate and descend (see diagram K).

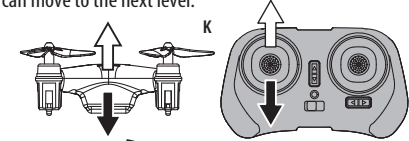

While in the air, move the right Throttle stick left and the Atom 1.0™ will rotate left.

Move the left Throttle stick right and the Atom 1.0™ will rotate right (see diagram L).

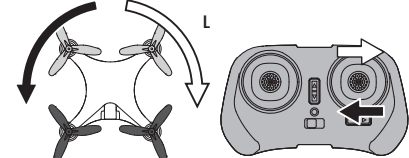

While in the air, move the right Direction Stick up and the Atom 1.0™ will move forward.

Move the right Direction Stick down and the Atom 1.0™ will move backward (see diagram M).

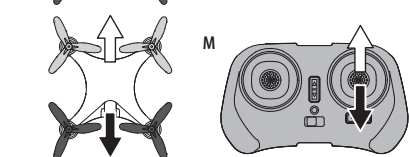

SWITCHING TO MEDIUM & HIGH SPEED MODE

To change the Atom 1.0's flight speed from the default (low speed) to medium and high speed flight mode:

1. Turn on the remote.
2. Depress the control lever on the left side straight down as if pressing a button to switch modes (see diagram N).
3. You will hear two beeps indicating that your drone speed changed to medium speed.
4. To change to high speed mode repeat step 2.
5. Three beeps indicates a speed changed to high speed mode.
6. To switch back to low speed repeat step 2 again, you will hear one beep indicating low speed mode.
7. Speed mode returns to low speed once the remote is turned off.

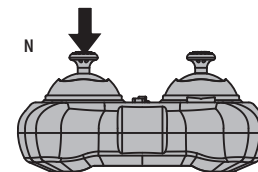

UNDERSTANDING TRIM ADJUSTMENTS

Forward/Backward Trim

- If your Atom 1.0™ is drifting forwards or backwards, you may need to adjust the FORWARD/BACKWARD TRIM (see diagram O).
- If your Atom 1.0™ drifts forward, push and release the BACKWARD TRIM button back repeatedly until the motion stops and proper flight is maintained.
- If your Atom 1.0™ drifts backwards, push and release the FORWARD TRIM button forward in the same manner until the problem is resolved.
- From time to time you may have to adjust the FORWARD or BACKWARD TRIM buttons to ensure the Atom 1.0™ will hover in mid-air and respond accurately to your commands.

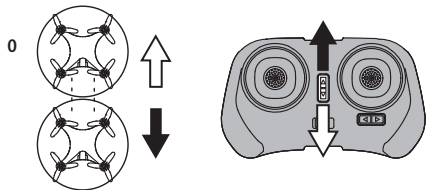

Right/Left Trim

- If your Atom 1.0™ is drifting left or right, you may need to adjust the LEFT/RIGHT TRIM button (see diagram P).
- If your Atom 1.0™ drifts left, push and release the RIGHT TRIM button repeatedly until the motion stops and proper flight is maintained.
- If your Atom 1.0™ drifts right, push and release the LEFT TRIM button in the same manner until the problem is resolved.
- From time to time you may have to adjust the LEFT or RIGHT TRIM buttons to ensure the Atom 1.0™ will hover in mid-air and respond accurately to your commands.

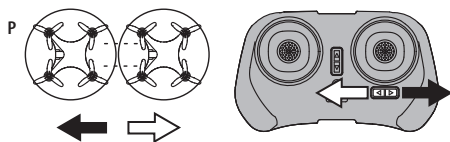

LEVEL SURFACE GYRO CALIBRATION

If the aircraft becomes unstable during the course of flying, or after a crash, you may need to recalibrate the onboard gyro chip. To do so, place the Atom 1.0™ on a flat level surface. Start by syncing the controller with the quadcopter. Next, pull the right control stick on the remote all the way down and to the right (approximately 45°) and hold for a couple of seconds. The LEDs on the Atom 1.0™ will flash quickly and then turn solid when released. This indicates your drone has been stabilized (see diagram Q).

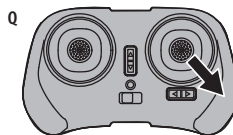

PERFORMING A 360° STUNT ROLL

Once the Atom 1.0™ is airborne,

1. Press the right control lever straight down.
2. Move the lever in the direction you wish to perform the 360° roll (see diagram R).

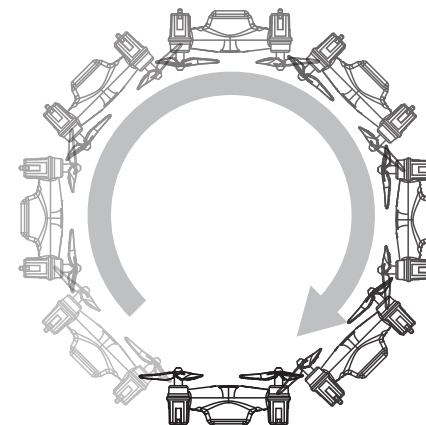
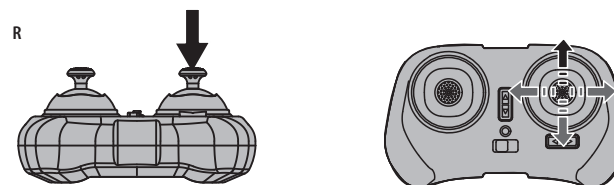

TROUBLESHOOTING YOUR ATOM 1.0™

PROBLEM	POSSIBLE REASON	SOLUTION
NO POWER	1. Power switched off 2. Polarity is reversed 3. Batteries may be dead	1. Switch the ON/OFF switch to ON 2. Make sure all batteries are installed correctly (see diagram B) 3. Replace batteries
Remote Not Responding	1. Remote is switched off 2. Atom 1.0™ is switched off 3. Too windy 4. The Remote light is flashing	1. Switch the ON/OFF switch to ON 2. Switch the ON/OFF switch to ON 3. Windy conditions severely affect the operation of the Atom 1.0™ 4. Replace batteries
Drone Won't lift off	1. Rotor speed too slow 2. Drone not fully charged	1. Push throttle lever forward 2. Recharge your Atom 1.0™
Drone Descends Too Fast	1. Moving the throttle too quickly	1. Control the throttle slower and smoother
Drone Not Responding	1. Gyroscopes not functioning	1. Turn on the Atom 1.0™ and Reset the Gyros (see diagram L)
Loss of Atom 1.0™ Control	1. Drone is out of range of remote	1. Keep the drone within a 20 meter radius of the remote

REPLACING THE PROPELLER BLADES

Your Atom 1.0™ propeller system is a precision instrument that may need repair or replacement from time to time for optimal flight function. Crash landing from high-speed aerial flights may cause damage to your Atom 1.0™'s propellers.

- Atom 1.0™ have four blades, two gray propellers on the front, and two black propellers on the back. Please note that the blades and the Atom 1.0™ are labeled with an embossed A or B (see the diagram S).
- When replacing the propeller blades, gently remove the blade from the rotor shaft. Make sure to match both the color of the blade and the indication letter on the blade with the letter on the aircraft.
- Replace the damaged blade with the correct blade.

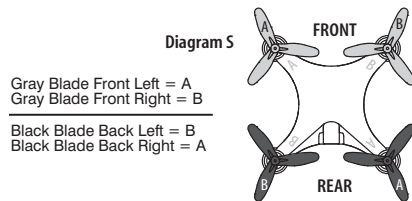

ATOM 1.0™ WARNING:

The Atom 1.0™ is designed for INDOOR or OUTDOOR flight. Atom 1.0™ 's blades revolve at high speeds and can cause damage to the user, spectators and animals. Stand away from the Atom 1.0™ to reduce the risk of getting into the flight path. Warn spectators that you will be flying your Atom 1.0™ so that they are aware of its position. Before flight, inspect the rotor blades to make certain that the blades are securely fastened to the Atom 1.0™.

WARNING!

- Choking/Cutting Hazard. Small Parts/Sharp Rotor Blades.
- Keep hands, hair and loose clothing away from the propeller when the power switch is turned to the ON position.
- Turn off the transmitter and Atom 1.0™ power switches when not in use.
- The included charger is built specifically for the Atom 1.0™ Li-Poly battery. Do not use it to charge any other battery.
- New alkaline batteries are recommended for maximum performance.
- Parental supervision recommended when flying Atom 1.0™

BATTERY WARNINGS

RECHARGEABLE BATTERY:

This Atom 1.0™ uses a Li-Poly rechargeable battery. If battery no longer stays charged, dispose of battery properly according to local disposal requirements.

CONTROLLER BATTERIES:

Remote control requires 2 "AAA" batteries (not included). Please read the important battery safety warning below.

- Do not mix alkaline, standard (carbon-zinc) and rechargeable batteries (Nickel Metal Hydride).
- Do not mix old and new batteries.
- Non-rechargeable batteries are not to be recharged.
- Rechargeable batteries are to be removed from the item before being charged (if removable).
- Rechargeable batteries are only to be charged under adult supervision.
- Exhausted batteries should be removed immediately and must be recycled or disposed of properly according to state or local government ordinances and regulations.
- The supply terminals are not to be short-circuited.
- Only batteries of the same or equivalent type as recommended are to be used.
- Batteries are to be inserted with the correct polarity (see inside booklet for diagram).
- Do not dispose batteries in a fire - batteries may leak or explode.

CARE AND MAINTENANCE

- Always remove the batteries from the wireless 2.4G remote control when it is not being used for an extended period of time.
- To clean, gently wipe the remote control and Atom 1.0™ with a clean damp cloth.
- Keep the toy away from direct heat or sunlight.
- Do not submerge the toy into water. This can damage the unit beyond repair.
- Parental guidance recommended when installing or replacing the batteries.