

**FCC Part 15 C Notice**

CAUTION: Changes or modifications not expressly approved by the party responsible for compliance could void the user's authority to operate the equipment.

NOTE: This equipment has been tested and found to comply with the limits for a Class B digital device, pursuant to Part 15 of the FCC Rules. These limits are designed to provide reasonable protection against harmful interference in a residential installation. This equipment generates, uses and can radiate radio frequency energy and, if not installed and used in accordance with the instructions, may cause harmful interference to radio communications. However, there is no guarantee that interference will not occur in a particular installation. If this equipment does cause harmful interference to radio or television reception, which can be determined by turning the equipment off and on, the user is encouraged to try to correct the interference by one or more of the following measures:

- Reorient or relocate the receiving antenna.
- Increase the separation between the equipment and receiver.
- Connect the equipment into an outlet on a circuit different from that to which the receiver is connected.
- Consult the dealer or experienced radio/TV technician for help.

This device complies with Part 15 of the FCC Rules. Operation is subject to the following two conditions :

- (1) This device may not cause harmful interference, and
- (2) this device must accept any interference received, including interference that may cause undesired operation.

**INDUSTRY CANADA NOTICE: CANADA ONLY.**

This device complies with Industry Canada licence-exempt RSS standard(s). Operation is subject to the following two conditions: (1) this device may not cause interference, and (2) this device must accept any interference, including interference that may cause undesired operation of the device.

Le présent appareil est conforme aux CNR d'Industrie Canada applicables aux appareils radio exempts de licence. L'exploitation est autorisée aux deux conditions suivantes : (1) l'appareil ne doit pas produire de brouillage, et (2) l'utilisateur de l'appareil doit accepter tout brouillage radioélectrique subi, même si le brouillage est susceptible d'en compromettre le fonctionnement.



Conforms to safety requirements of FCC.  
 PROPEL RC™ and CLOUD RIDER™ are trademarks of Rooftop Brands.  
 8619 Wall street, Suite 400, Austin, TX 78754 tel: 949.566.9573  
 © 2016 Rooftop Brands™. All Rights Reserved. www.propelrc.com.

Made in China

# Cloud Rider™

## 2.4GHz Quadrocopter With HD Camera

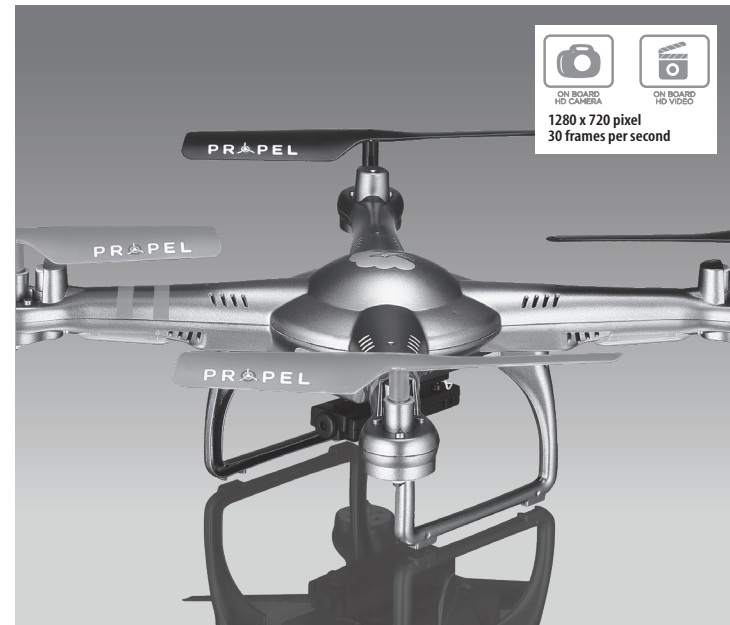

**INSTRUCTION BOOKLET**

**WARNING:** Never leave product charging unattended for extended periods of time. Always disconnect Cloud Rider™ battery from charger immediately after it is fully charged. Please refer to enclosed safety instructions.

**PACKAGE CONTAINS:**

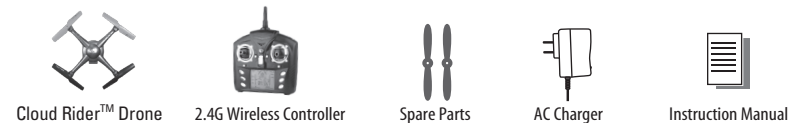

Colors and styles may slightly vary.



## TABLE OF CONTENTS

Product Features .....	2
Remote Control Battery Installation .....	2
Charging Your Cloud Rider™ Battery .....	2
Cloud Rider™ Quadcopter Diagram .....	3
Remote Control Diagram .....	3
Remote LCD Diagram .....	3
Flight Preparation .....	4
Syncing Your Cloud Rider™ .....	4
Flying Tips .....	4
Recognizing The Front & Back Of The Cloud Rider™ .....	5
4 Channel Flight Control .....	5
Adjusting Trim .....	6
Level Surface Calibration .....	6
Flight Environment .....	6
Flight Practice .....	7
Performing a 360° Stunt Flip .....	7
Trouble Shooting .....	8
Attaching Camera .....	8
Operating The Camera .....	9
Replacing The Propeller Blades .....	9
Warnings .....	10
Battery Warnings .....	10
Care and Maintenance .....	10
FCC Information .....	11

## FEATURES

- 6 Axis Gyro For Extremely Stable Flight and Maneuverability
- Wide Range Digital Radio Allows Flight Range Up To 500 Feet
- Takes Video and Still Shots With Onboard Camera
- 3 Speed Settings From Beginner To Advanced Pilots
- 360 Degree Push Button Stunt Rolls
- 2.4 Ghz Controller, Replaceable Li-poly Battery and Additional Replacement Parts Included.

## REMOTE CONTROL BATTERY INSTALLATION

1. Remove the battery cover from the back of the controller as shown in diagram A.
2. Install 6 "AA" fresh alkaline batteries into the controller as shown in diagram B. Make sure to install batteries to their correct polarity. Do not mix old and new batteries or battery types.
3. Replace the battery cover.

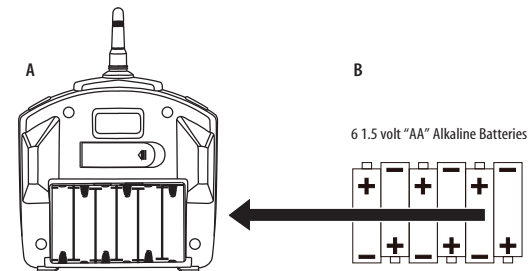

## CHARGING YOUR CLOUD RIDER™ Li-POLY BATTERY

1. Connect the battery to the female connector end of the charger cable and plug the charger into a standard outlet (see diagram C).  
CAUTION: improper connection may damage the Cloud Rider™.
2. The indicator light will glow red while the unit is charging. When the RED Led light turns off your battery has a complete charge.
3. Average charging time is around 100 minutes to fully charged.
4. A full charge will allow for about 7-10 minutes of flight time depending on environment and user input.

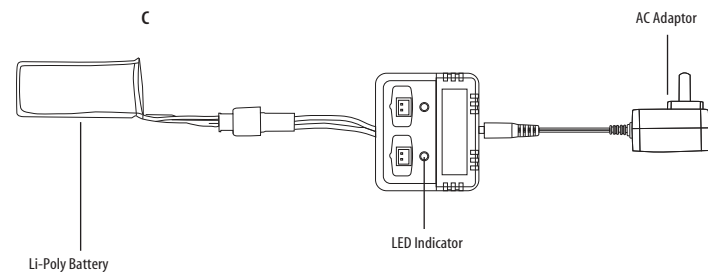

Thank you for purchasing the Cloud Rider™ 2.4 Ghz Quadcopter. Please read this instruction booklet as it contains valuable information on how to properly fly and care for your Cloud Rider™ Drone.

**IMPORTANT: ALWAYS REMEMBER TO UNPLUG YOUR CHARGING CORD WHEN NOT IN USE!**

### CLOUD RIDER™ QUADROPTER DIAGRAM

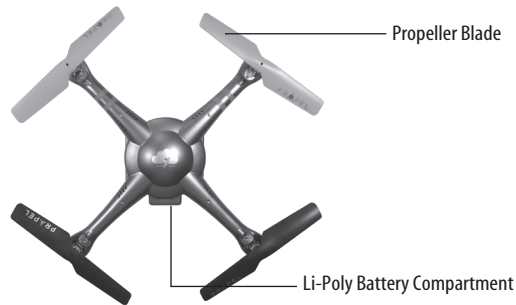

### CLOUD RIDER™ REMOTE DIAGRAM

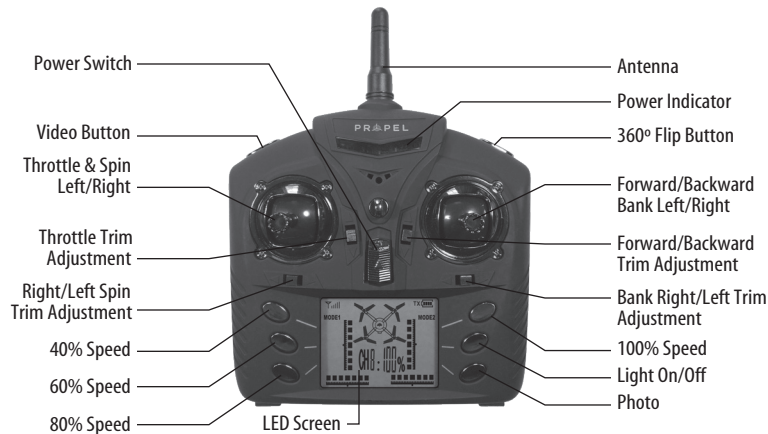

### CLOUD RIDER™ REMOTE LCD DIAGRAM

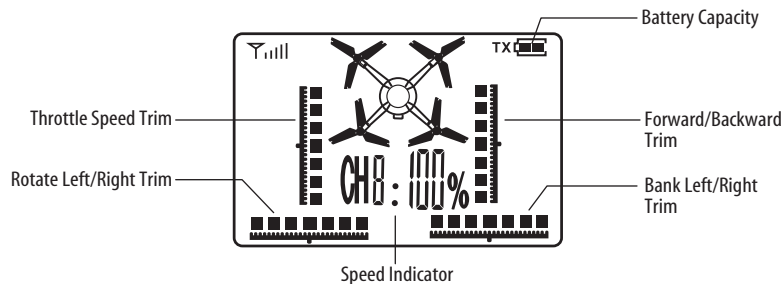

## WARNING

**DO NOT FLY YOUR CLOUD RIDER™ IN FOUL WEATHER!**



### FLIGHT PREPARATION

- Verify that there are 6 "AA" batteries inside the remote control unit and the Cloud Rider™ has been fully charged.
- Make sure your Cloud Rider™ and controller are both turned on.
- Make sure to be in a large space with an open radius of at least 200 feet.
- Make sure the empty space has no obstacles. Set your Cloud Rider™ on a clean flat surface before take-off.

**DO NOT ATTEMPT TO FLY YOUR CLOUD RIDER™ IF THERE IS RAIN, SNOW, HEAVY WINDS, THUNDER OR LIGHTNING OUTDOORS. IT COULD DAMAGE YOUR PRODUCT AND POSSIBLY EVEN CAUSE BODILY HARM.**

### SYNCING YOUR CLOUD RIDER™

**Important!** When syncing your Cloud Rider™ quadcopter with the controller always make sure that the quadcopter is on a flat level surface and that your digital trim settings are in the center position. This insures that the 6 Axis gyro is properly programmed to mimic your trim settings.

Your Cloud Rider™ utilizes an automatic 2.4G channel selection system that allows up to 8 people to fly side by side in the same wireless range with no interference.

#### Syncing your aircraft:

1. Before starting, make sure that the power on your controller is in the OFF position and the Cloud Rider™ wire leads are not connected. Make sure that there are no other 2.4Ghz devices in the area as well .
2. Open the battery compartment. Connect the battery wire lead to the Cloud Rider™ and set it down on a flat surface. The LED indicator lights of the Cloud Rider™ should begin to flash (see diagram D). Insert battery and close compartment.
3. Next turn ON the remote controller. After hearing a series of beeps, the Cloud Rider's™ flashing LED lights will change to a solid glow signaling that the drone and controller have been synced. If this does not happen, repeat all steps above.

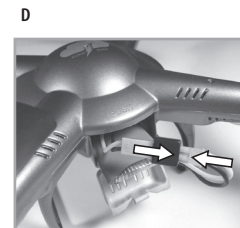

### FLYING TIPS

- It is recommended that you operate the Cloud Rider™ outdoors in a wide space. The ideal space should have a 200 foot radius.
- Parental guidance or adult supervision is suggested at all times.
- If you are flying the Cloud Rider™ with others, make sure all spectators are behind you.
- For best performance, it is recommended that you operate the Cloud Rider™ in zero wind conditions. Wind can greatly affect the performance of the aircraft or cause injury.

## RECOGNIZING THE FRONT & BACK OF THE CLOUD RIDER™

Even though the Cloud Rider™ has four rotors there is still a front or "forward" facing direction and "back" or backwards facing direction. The front of the Quadcopter displays GREEN LED lights and the back of the Quadcopter displays RED LED lights when activated (see diagram E).

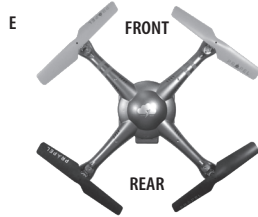

## 4 CHANNEL FLIGHT CONTROL

Below is a list of basic flight functions for your long-range remote control Cloud Rider™. While learning to fly your Cloud Rider™ it is best to start with a large space until you get used to the basic controls. As you master flying your Cloud Rider™ you can move to more advanced maneuvering techniques. Practice makes perfect! When you have these basic steps down you can move to the next level.

Move the left Throttle stick up to increase the speed and the Cloud Rider™ will accelerate and ascend.

Move the left Throttle stick down to decrease the speed and the Cloud Rider™ will decelerate and descend (see diagram F).

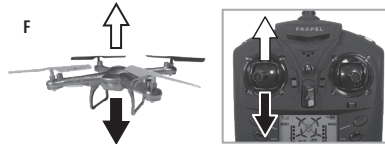

Move the left Throttle stick left and the Cloud Rider™ will rotate left.

Move the left Throttle stick right and the Cloud Rider™ will rotate right (see diagram G).

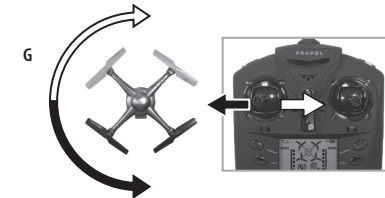

Move the right Direction Stick up while in flight and the Cloud Rider™ will move forward.

Move the right Direction Control down while in flight and the Cloud Rider™ will move backward (see diagram H).



Move the right Direction Control left and the Cloud Rider™ will bank to the left.

Move the right Direction Control right and the Cloud Rider™ will bank to the right (see diagram I).



## ADJUSTING TRIM

From time to time you may have to adjust the TRIM buttons to ensure the Cloud Rider™ will hover in mid-air and respond accurately to your commands (make all trim adjustments while the drone is in air).

### Forward/Backward Trim

- If your Cloud Rider™ drifts forward, push and release the BACKWARD TRIM button back repeatedly until the motion stops and proper flight is maintained (see diagram J).
- If your Cloud Rider™ drifts backwards, push and release the FORWARD TRIM button forward in the same manner until the problem is resolved.

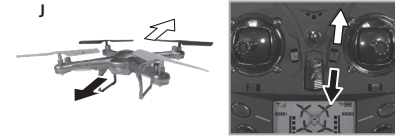

### Right/Left Trim

- If your Cloud Rider™ drifts left, push and release the RIGHT TRIM button back repeatedly until the motion stops and proper flight is maintained (see diagram K).
- If your Cloud Rider™ drifts right, push and release the LEFT TRIM button in the same manner until the problem is resolved.



### Right/Left Spin Trim

- If your Cloud Rider™ spins left, push and release the RIGHT SPIN TRIM button back repeatedly until the motion stops and proper flight is maintained (see diagram L).
- If your Cloud Rider™ spins right, push and release the LEFT SPIN TRIM button in the same manner until the problem is resolved (see diagram M).

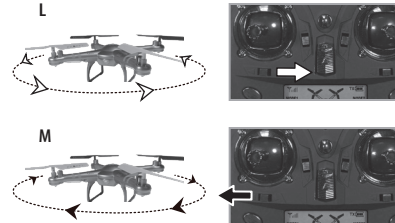

## LEVEL SURFACE CALIBRATION

If the aircraft becomes unstable during the course of flying, you may need to re stabilize the internal gyros.

To do this, Turn Off the controller and disconnect the Drone battery. Place the Cloud Rider on a flat level surface. Follow the steps to sync your Cloud Rider (page 4). Now, pull both the joysticks downwards and towards the left at the same time (see diagram N). The lights on the drone will flash a bit and then remain solid. This indicates that your drone has been calibrated.

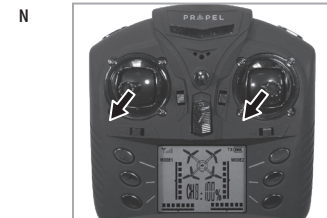

## FLYING ENVIRONMENT

The Cloud Rider™ is designed for outdoor use only. When flying, do so in warm sunny weather with no wind or rain.

**WARNING:** Do not fly in extreme temperatures or windy conditions as this may affect the performance of your Cloud Rider™ and cause damage or injury.

## FLIGHT PRACTICE

To master flying your aircraft try practicing the exercises shown below. Start with simple vertical takeoffs, landings, and left/right turning and rotating. Once those are mastered move on to square and cross maneuvers. Good luck and have fun!

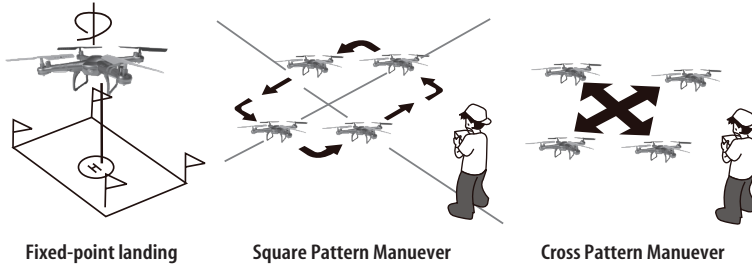

## PERFORMING 360° FLIPS

After you have mastered flying the Cloud Rider™ you are ready to try flips. Once the Cloud Rider™ is hovering at least 3 meters (about 10 feet) off the ground, trigger the 360° Flip Button (see diagram O) and push the right lever forward slightly and let go. The Cloud Rider™ will instantly perform a forward flip. To perform a backwards or side flip press and hold the 360° Flip Button and push the right lever in the direction you wish to flip just as you did for the forward flip (see diagram P & Q).

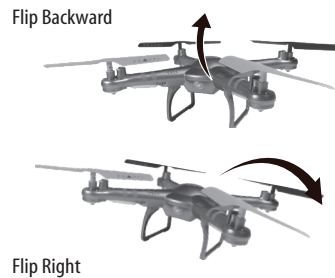
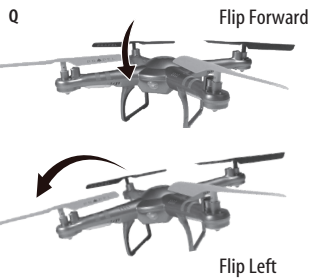

## TROUBLESHOOTING YOUR CLOUD RIDER™

PROBLEM	POSSIBLE REASON	SOLUTION
No Power	<ol style="list-style-type: none"> <li>1. Power switched off</li> <li>2. Polarity is reversed</li> <li>3. Batteries may be dead</li> </ol>	<ol style="list-style-type: none"> <li>1. Switch the ON/OFF switch to ON</li> <li>2. Make sure all batteries are installed correctly (see diagram B)</li> <li>3. Replace batteries</li> </ol>
Remote Not Responding	<ol style="list-style-type: none"> <li>1. Remote is switched off</li> <li>2. Cloud Rider™ battery is not connected</li> <li>3. Too windy</li> <li>4. The remote is not synced</li> </ol>	<ol style="list-style-type: none"> <li>1. Switch the ON/OFF switch to ON</li> <li>2. Connect the battery to Cloud Rider™ properly</li> <li>3. Windy conditions severely impair the operation of the Cloud Rider™</li> <li>4. Re-sync the remote</li> </ol>
Aircraft Won't lift off	<ol style="list-style-type: none"> <li>1. Rotor speed too slow</li> <li>2. Aircraft not fully charged</li> </ol>	<ol style="list-style-type: none"> <li>1. Push throttle lever forward</li> <li>2. Recharge your Cloud Rider™</li> </ol>
Aircraft Descends Too Fast	<ol style="list-style-type: none"> <li>1. Moving the throttle too quickly</li> </ol>	<ol style="list-style-type: none"> <li>1. Control the throttle slower and smoother</li> </ol>
Aircraft Not Responding	<ol style="list-style-type: none"> <li>1. Gyroscopes not functioning</li> </ol>	<ol style="list-style-type: none"> <li>1. Turn ON the Cloud Rider™ and Reset the Gyros (see diagram P)</li> </ol>
Loss of Cloud Rider™ Control	<ol style="list-style-type: none"> <li>1. Aircraft is out of range of remote</li> </ol>	<ol style="list-style-type: none"> <li>1. Keep the aircraft within a 300 feet radius of the remote</li> </ol>

## ATTACHING THE OPTIONAL CAMERA

You have the option of attaching the optional camera with precision to your Cloud Rider™ quadcopter.

1. Install the camera on the under side of the Cloud Rider™ by sliding the camera forward into position and adjust lens angle (see diagram Ra & Rb).
2. Connect the camera lead to the Cloud Rider™ in the appropriate connection plug (see diagrams Sa & Sb).

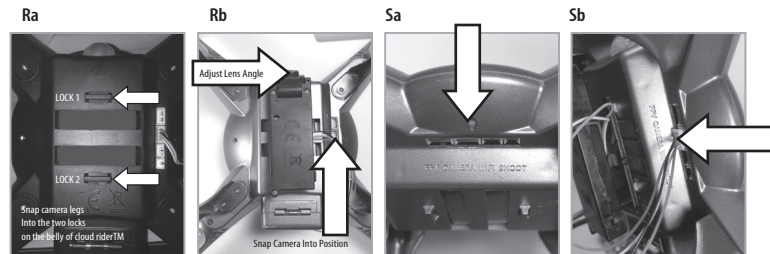

Consult your retailer for additional attachable devices

## OPERATING THE CAMERA

You can take in-flight photos or video with your Cloud Rider™ on board camera.

1. Once the camera is attached and connected insert the Micro SD card into the camera body (see diagram T).
2. To take still photos press the photo button on the remote (see diagram T1).
3. To take video footage press the Video button on the remote (see diagram T1). To stop video footage simply press the video button again.
4. To retrieve your photos and footage remove the card once the Cloud Rider™ has landed safely and insert the card into the USB card reader provided and connect to your computer's USB port and download the photos and video footage (see diagram T2).

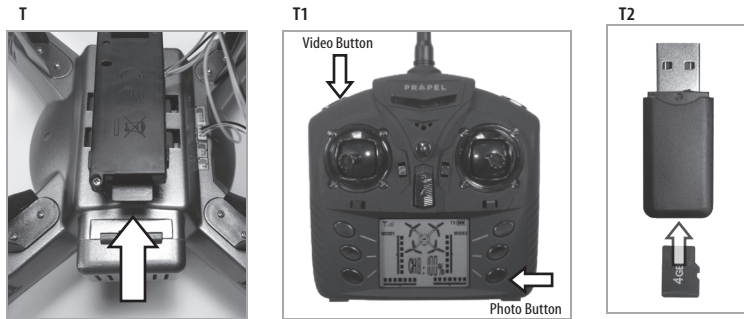

## REPLACING THE PROPELLER BLADES

**NOTE : Always disconnect the battery before replacing the propeller blades.**

Your Cloud Rider™ propeller system is a precision instrument that may need repair or replacement from time to time for optimal flight function. Crash landing from high-speed aerial flights may cause damage to your Cloud Rider™ propellers.

The Cloud Rider™ has four propeller blades, two on the front and two on the back. Each one of these propellers is marked with either A or B on the underside.

1. When replacing the propeller blades, carefully unscrew the broken propeller from the rotor shaft.
2. Replace the damaged blade with the correct new blade. Ensure that the identification letter on the broken blade and on the new blade are the same before screwing back on (See diagram U).

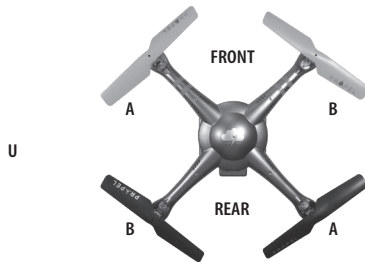

## CLOUD RIDER™ WARNING:

The Cloud Rider™ is designed for OUTDOOR use only. The Cloud Rider™ blades revolve at high speeds and can cause damage to the user, spectators and animals. Stand away from the Cloud Rider™ to reduce the risk of getting into the flight path. Warn spectators that you will be flying your Cloud Rider™ so that they are aware of its position. Before flight, inspect the rotor blades to make certain that the blades are securely fastened to the Cloud Rider™.

### WARNING!

- Choking/Cutting Hazard. Small Parts/Sharp Rotor Blades.
- Keep hands, hair and loose clothing away from the propeller when the power switch is turned to the ON position.
- Turn off the transmitter and Cloud Rider™ when not in use.
- The included charger is built specifically for the Cloud Rider™ Li-Poly battery. Do not use it to charge any other battery.
- New alkaline batteries are recommended for maximum performance.
- Parental supervision recommended when flying Cloud Rider™.

## BATTERY WARNINGS

### RECHARGEABLE BATTERY:

This Cloud Rider™ uses a Li-Poly rechargeable battery. If battery no longer stays charged, dispose of battery properly according to local disposal requirements.

### CONTROLLER BATTERIES:

Remote control requires 6 "AA" batteries (not included). Please read the important battery safety warning below.

- Do not mix alkaline, standard (carbon-zinc) and rechargeable batteries (Nickel Metal Hydride).
- Do not mix old and new batteries.
- Non-rechargeable batteries are not to be recharged.
- Rechargeable batteries are to be removed from the item before being charged (if removable).
- Rechargeable batteries are only to be charged under adult supervision.
- Exhausted batteries should be removed immediately and must be recycled or disposed of properly according to state or local government ordinances and regulations.
- The supply terminals are not to be short-circuited.
- Only batteries of the same or equivalent type as recommended are to be used.
- Batteries are to be inserted with the correct polarity (see inside booklet for diagram).
- Do not dispose batteries in a fire - batteries may leak or explode.

## CARE AND MAINTENANCE

- Always remove the batteries from the wireless remote control when it is not being used for an extended period of time.
- To clean, gently wipe the remote control and Cloud Rider™ with a clean damp cloth.
- Keep the toy away from direct heat or sunlight.
- Do not submerge the toy into water. This can damage the unit beyond repair.
- Parental guidance recommended when installing or replacing the batteries.