



**IMPERIAL FLIGHT MANUAL**



**HIGH PERFORMANCE BATTLING DRONES**

# HIGH PERFORMANCE BATTLE DRONES

## 74-Z SPEEDER BIKE

### IMPERIAL MANUAL

WARNING: Never leave Li-poly batteries charging unattended for extended periods of time. Please refer to enclosed safety instructions.

#### PACKAGE CONTAINS:

- 74-Z SPEEDER BIKE
- 2.4 Ghz WIRELESS CONTROLLER
- 2 SPEEDER BIKE BATTERIES
- INSTRUCTION BOOKLET
- CHARGER+ USB CABLE+ WALL ADAPTER  
(wall adapter + USB is for both packaging and battery charger)
- PROTECTIVE TRAINING CAGE
- LIGHT SABER SCREWDRIIVER (in side of controller)
- PROPELLER MULTI-TOOL
- FAUX BATTERY COVER (for use with collectors display box)
- SPARE PARTS
- COLLECTORS LIGHT UP DISPLAY BOX

Colors and styles may vary



## CONGRATULATIONS, TROOPER.

You are now a member of the greatest fighting force the galaxy has ever seen.

Through your efforts and the diligence of those who serve alongside you, we will restore order to the civilized systems.

We will crush the traitors of the Rebel Alliance. And we will never fail in our loyal service to his Imperial majesty Emperor Palpatine.

This manual contains the information you require to master your chosen ship, the 74-Z Speeder Bike.

You must complete your training before the Empire will consider you a profitable investment when considering whether to risk its valuable military assets.

No further delays. Report for duty at once!

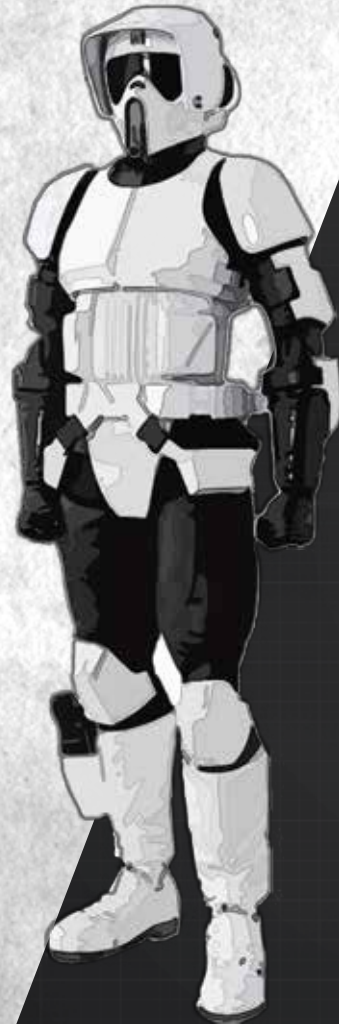

For the latest information about our Star Wars drones please scan this code

or visit us at  
[www.propelsw.com](http://www.propelsw.com)

## YOUR VESSEL

The 74-Z Speeder Bike from Aratech has been tuned to meet Imperial military standards and is among the finest repulsorcraft ever created. Its speed and responsiveness are unassailable, and reports of fatal crashes are merely attributable to inferior operators who couldn't handle the power at their disposal.

Imperial scout troopers across the galaxy rely on the 74-Z speeder bike every day, and frequently find themselves in combat against Rebel starfighters. With a flight ceiling of more than 25 meters, your Speeder Bike can take down an X-wing if it has the right trooper at the controls.

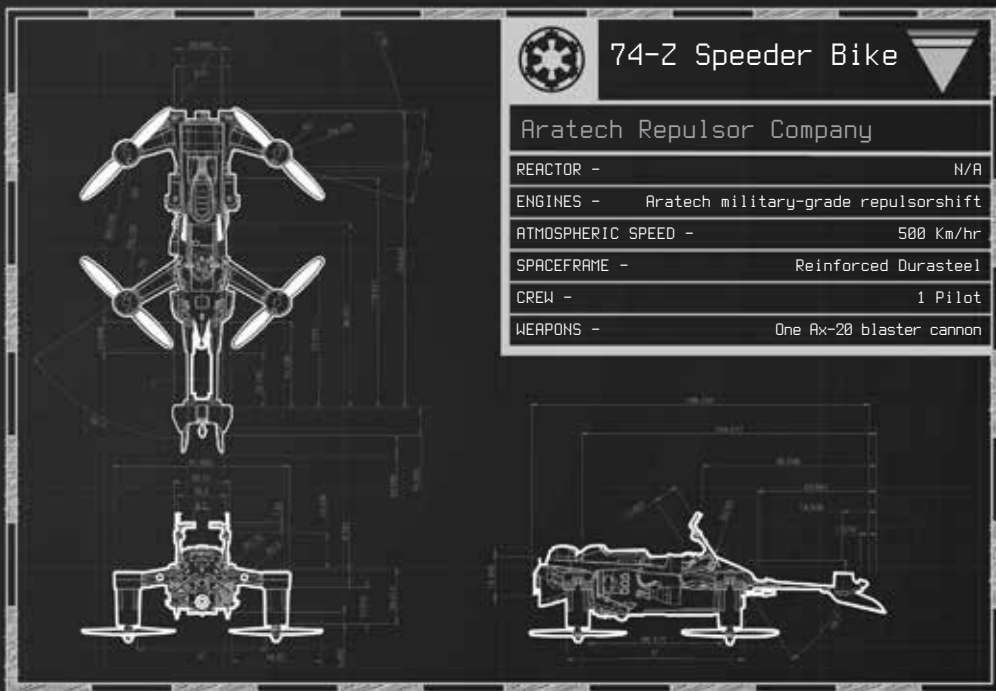

## TABLE OF CONTENTS

## PAGE

|  |                             |
|--|-----------------------------|
| <b>01.</b> Features                                      | 06                          |
| <b>02.</b> Starship Stats                                | 07                          |
| <b>03.</b> Pilots Gear                                   | Fold out page (After Pg. 7) |
| <b>04.</b> Removing the speeder bike from the box        | 09                          |
| <b>05.</b> Packaging Functions                           | 09                          |
| <b>06.</b> Controller battery installation               | 10                          |
| <b>07.</b> Speeder bike battery installation             | 11                          |
| <b>08.</b> Charging your vessels battery                 | 12                          |
| <b>09.</b> Replacing the propeller blades                | 13                          |
| <b>10.</b> Turning your controller on                    | 14                          |
| <b>11.</b> Syncing your vessel                           | 14                          |
| <b>12.</b> Controller Functions                          | 15                          |
| <b>13.</b> Learning how to fly (T-mode)                  | 18                          |
| <b>14.</b> Protective Cage                               | 19                          |
| <b>14.</b> Preparing for flight                          | 20                          |
| <b>15.</b> Flight Controls                               | 21                          |
| <b>16.</b> Flying tips                                   | 22                          |
| <b>17.</b> Recognizing the front and back of your vessel | 22                          |
| <b>18.</b> Speed select                                  | 22                          |
| <b>19.</b> Turn On/Off LEDs & Lasers                     | 23                          |
| <b>20.</b> Auto start and Auto land                      | 24                          |
| <b>21.</b> Combat  | 24                          |
| <b>22.</b> Warnings                                      | 35                          |
| <b>23.</b> FCC Notice                                    | 37                          |
| <b>24.</b> Industry Canada notice                        | 38                          |
| <b>25.</b> Warranty                                      | 39                          |
| <b>26.</b> Pilots Log                                    | 40                          |

# TABLE OF CONTENTS



## FEATURES:

- Built-in 6 axis gyroscopic chip keeps the Speeder bike extremely stable in all conditions
- 4-channel flight controls allow for incredible maneuvering including 360° aerial stunts
- LED directional lights make your Vessel easy to follow
- Hand-painted to model quality finish
- Running lights illuminate your Vessel during low-light flying
- Barometric pressure sensor (repulsor lift) For fixed altitude hovering
- Auto-start and auto-land functions
- Gyroscope calibration
- Crash protection with Auto-Land
- T-Mode training for beginners
- Light-up display with soundtrack
- Controller vibration for battle feedback
- Replaceable batteries for extended play
- Infrared battling technology
- Upgradeable laser battling technology
- Built-in Star Wars soundtracks for complete sonic immersion
- Battle sounds
- Controller speaker and headphone jack
- Flight simulator smart-phone app for pilot training and profile creation
- Collectible identifying marks for traceability
- Easy-to-replace parts and transparent blades
- Protective cage
- Wax seal (If you are reading this you have already broken the wax seal)
- Lightsaber screwdriver for replacing controller batteries and Vessel repair
- And a few fun surprises



## STARSHIP STATS



### 74-Z SPEEDER BIKE™



**Engine:** Aratech military-grade repulsorlift

**Land Speed:** 500 km/hr

**Construction:** Reinforced durasteel

**Operators:** 1 pilot

**Weapons:** One Aa-20 blaster cannon

ARATECH REPULSOR COMPANY



### TIE ADVANCED XI™

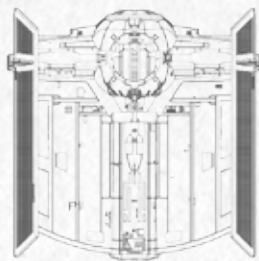

**Reactor:** SFS 1-s3a solar ionization

**Engines:** SFS P-s5.6 twin ion

**Atmospheric speed:** 1200 km/hr

**Spaceframe:** Reinforced durasteel

**Crew:** 1 pilot

**Weapons:** Two L-s9.3 laser cannons

SIENAR FLEET SYSTEMS



### T-65 X-WING™

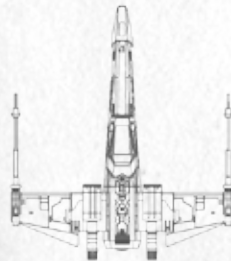

**Reactor:** Novaldex 04-2 cryogenic power cell

**Engines:** Four Incom 4L4 fusial thrust

**Atmospheric speed:** 1850 km/hr

**Spaceframe:** Titanium alloy

**Crew:** 1 pilot, 1 astromech droid

**Weapons:** Four Taim and Bak KX9 laser cannons

INCOM CORPORATION





# PILOT'S GEAR

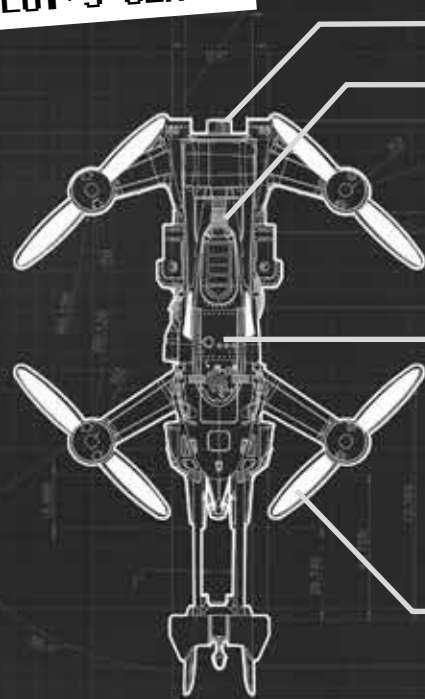

Back Lights

Battery Lock

Bluetooth Sync for future app integration

Barometric pressure sensor On/Off

Battery

Auto-start / Auto-land

Neck Strap Attachment  
(strap not included)

Propellers

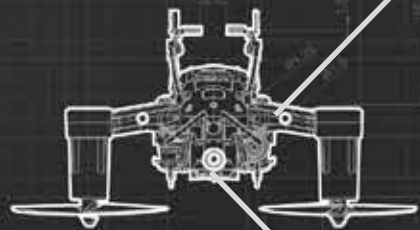

IR Transmitter

Speed change

Counter-Clockwise Roll

Left Gimbal (Control stick)

IR Receiver



Life LED s

Calibrate Gyro

Turn On/Off LED s

Speaker

Headphone Jack

Controller Power on/off

Battery Cover

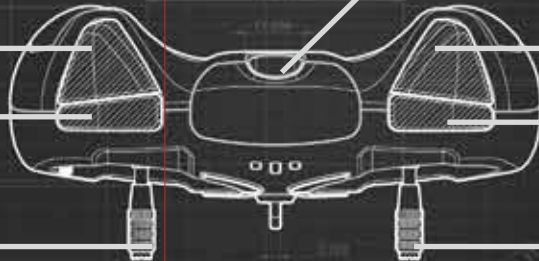

Phone holder Pull tab

Weapons Fire

Clockwise Roll

Right Gimbal (Control stick)

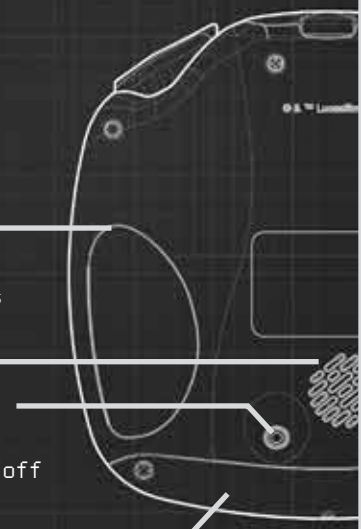

Handle grip

Extended Phone Holder Detail

## THE REBELLION

THE REBEL ALLIANCE HAS ONLY ONE GOAL—GALACTIC ANARCHY. THEIR COWARDLY RAIDERS HIDE IN THE SHADOWS TO STRIKE, BUT THEY SCATTER LIKE MYNOCKS WHEN THE EMPIRE BRINGS ITS SUPERIOR FIREPOWER TO BEAR.

IT IS YOUR DUTY TO WIPE OUT THESE VERMIN.



### IMPERIAL FLEET

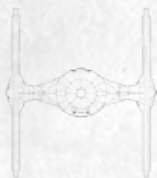

TIE/LN  
TIE Fighter

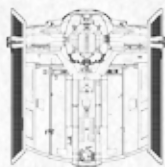

TIE Advanced  
X1

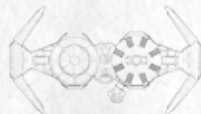

TIE/sa Bomber



74-Z  
Speeder Bike



### REBEL FLEET



RZ-1 A-Wing  
Interceptor



B-Wing/E

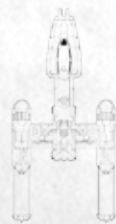

BTL Y-Wing



T-65 X-Wing

← OPEN PAGE - TOP SECRET

## REMOVING THE SPEEDER BIKE FROM THE DISPLAY CASE:

Carefully remove the top cover of the box and the acrylic window from the packaging, and place them somewhere safe. To free the vessel from the support, gently pull up on the body of the Vessel and release the motors from the rubber grommets. Slowly pull the vessel away from the surface of its support, making sure not to force it.

Important note: For packaging and display purposes the propeller blades are not pre-installed on the vessel. You will need to follow instructions on installing propeller blades page 13

## DISPLAY CASE FUNCTIONS:

When the cover is removed, the inside display case will come to life with light and music.

Note: Each time you replace the cover of the box and open it, a new music track will play.

To recharge the display case, first remove the acrylic top. This will give you access to the display charging port in the back side of the display fixture. Use the included USB cable and wall adapter. When the display is charging, the sound and lights will turn off. When the battery is fully charged, the display lights will turn on again. Now you are ready to replace the acrylic top of your display box.

If you are unsure if the battery is charging, remove the charging cable after several minutes of charging and the display should light up. Fully charging the display case takes approximately 40-60 minutes under normal conditions.

Note: be sure to disconnect the charging cable once the packaging is fully charged to preserve the battery.

When battery is low the Display lights will flash.



**DON'T THROW AWAY THE BOXES...**

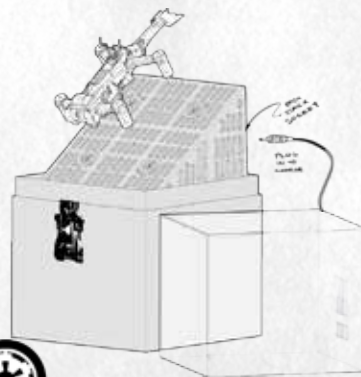

## REMOTE CONTROL BATTERY INSTALLATION



**USE ALKALINE OR  
1.5V RECHARGABLE  
BATTERIES**

### NOTES

- 1 -Unscrew and slide
- 2 -4 AA batteries
- 3 -Put back cover

**ALL THE LEDS ON THE  
CONTROLLER SHOULD BE  
FLASHING**



0000 1111 2222 3333

1. On the back of the controller, unscrew and slide off the battery cover - there is a screw driver hidden in the right side arm of the controller.

2. Install 4 AA alkaline batteries (1.5v rechargeable batteries are preferred) into the controller. - Check proper orientation!

3. Replace the battery cover and secure it with screws.

4. Replace the screwdriver into the side of the controller.

5. Turn over the controller and push the power button for 2 seconds, and verify that the LED

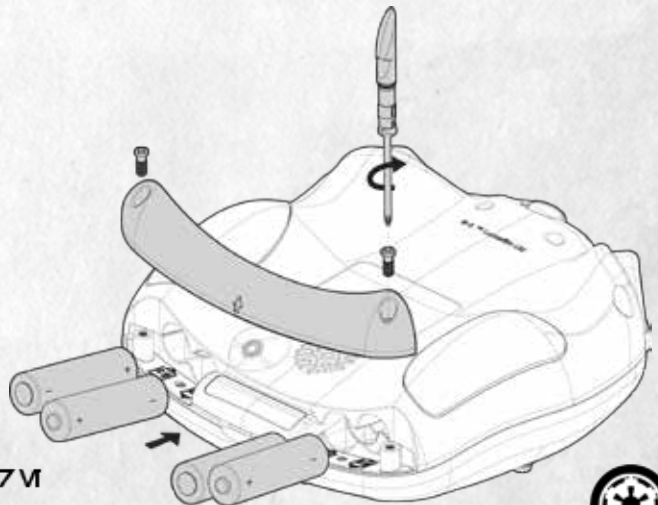

## SPEEDER BIKE BATTERY INSTALLATION:

1. During your first installation, slide the clasp to the unlocked position (as shown in illustration) to unlock the battery. Next, remove the battery cover that comes in the package, as this cover is cosmetic and used for display purposes only.
2. Slide the fully-charged battery into the Vessel's battery compartment (see diagram).
3. Push down and make sure the battery is fully seated as shown below. The Ship's LED lights will illuminate and start flashing when the battery is properly connected.
4. Close the clasp to lock the battery securely in place.

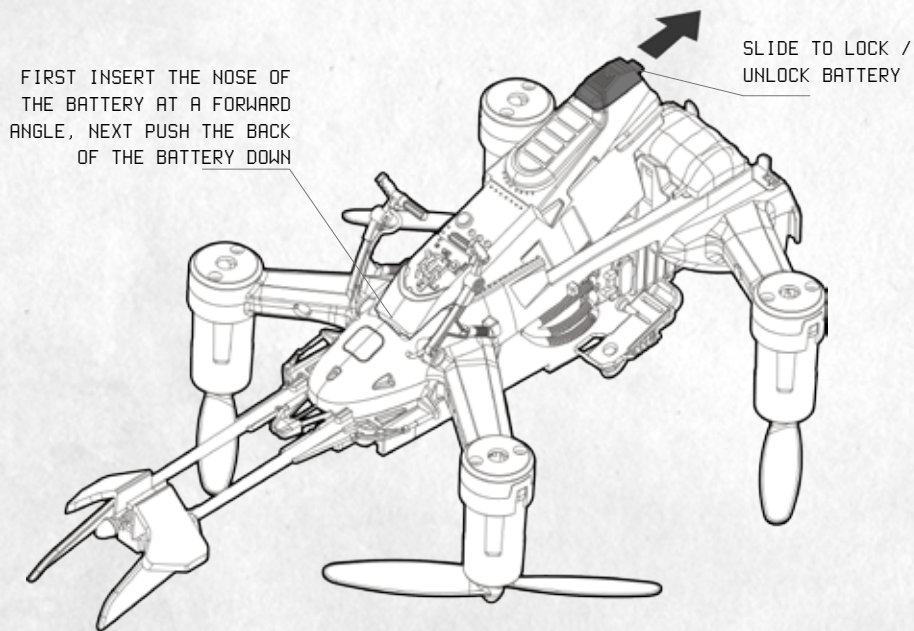

NOTE: The Vessel has no on/off switch, and automatically turns on when the LI-POLY battery is connected. To Switch off simply unlock, and remove the Battery.

## CHARGING YOUR VESSELS LI-POLY BATTERY

1. Insert the correct wall socket extension into the wall adapter depending on the country you are in (see illustration A).
2. Next, connect the USB charging cord to the wall adapter and the charger.

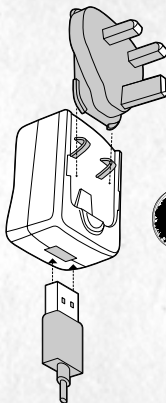

Illustration A

Note: The Charging adapter will show a RED indicator light when plugged in, and a blinking red indicator light when charging the battery.



**STEADY RED** -> Plugged in

**BLINKING RED** -> Charging  
in progress

3. When the Vessel's battery is charged to 90%, the charging indicator light will turn blue.

4. When the Vessel's battery is fully charged, the charging indicator light will turn green.



**GREEN**  
Fully charged



**BLUE**  
90% charged

5. Average charging time is approximately 30 minutes to reach 90% charge and an additional 10 minutes to charge completely. We suggest flying at A 90% charged battery. A 90% charged battery can power your vessel for 6-8 minutes depending on environment and flight aggressiveness. Never leave li-poly batteries sitting in charger for extended periods of time.

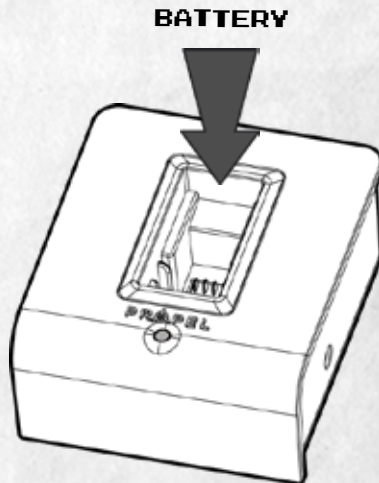

## PROPELLER INSTALLATION AND REPLACEMENT:

Your Speeder Bike's propeller system is a precision instrument that may need repair or replacement from time to time for optimal flight function. Crash landing from high-speed aerial flights may cause damage to your propellers.

1. The Ship has four propellers, two A Propellers, and two B Propellers,
2. When installing the propeller blades, make sure to put A propellers on A Motors, and B Propellers on B motors, as per the diagram at the right.
3. To replace the blade, gently pull off the broken blade and snap the new correct blade in place by pushing down firmly.

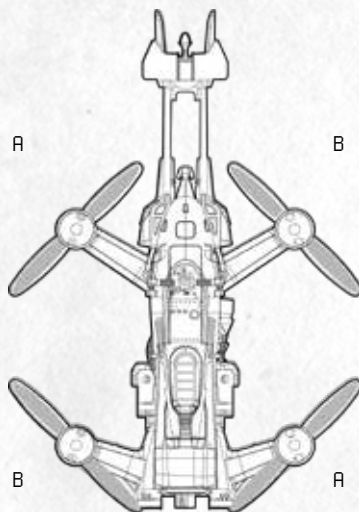

### Multi-Tool:

The multi-tool is used to help install and remove the propellers from the Vessel.

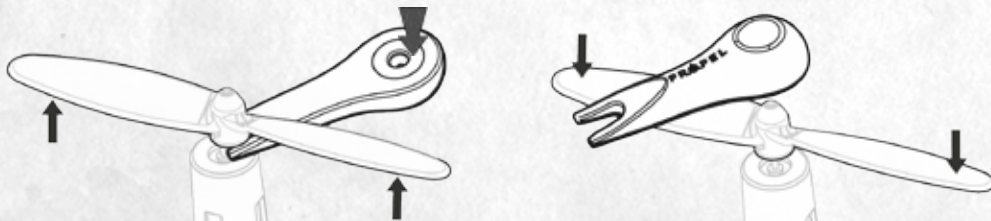

1. To remove the propeller wedge the thin side of the multi-tool between the motor mount and the propeller and push the propeller upwards.
2. To install the propeller use the opposite side of the multi-tool to push down on the propeller blade. You will notice some pressure and then the blade will move into place. The proper position of the propeller is when the base of the blade shaft is seated slightly below the motor hole. Always check to make sure that the blade spins freely.

## WARNING!

Do not fly your Ship in foul weather!



### 2 SECOND PUSH ON/OFF

At this point you may choose to listen to the opening soundtrack that plays when you power on your controller, whilst you continue reading this handbook.

### ALL LIGHTS FLASHING RED



## CONTROLLER POWER ON/OFF

Hold button for 2 seconds and the power will turn on, followed by a slight vibration. All LEDs (life LEDs and speed LEDs) will flash red until the controller is synced to the Vessel.

Hold button for 2 seconds and the power will turn off. The vibration motor will spin and all LEDs will flash red for 3 seconds.

## SYNC TO VESSEL: FOR SINGLE PERSON PLAY

Push the left control stick all the way up until you hear 1 beep, then push the stick all the way down. You will hear 2 beeps to indicate the controller is synced. Once synced, the LEDs surrounding the power button will illuminate to indicate the selected speed.

At this point you may want to listen to the opening soundtrack that plays after your controller powers on, while you continue reading.



## MUSIC MODE

Music mode lets you adjust the volume on your speaker or headphones or choose a background track. To enter music mode, hold down button (2) and button (4) for two seconds. The Life LEDs will glow blue. Push both buttons again for two seconds to exit music mode. If no buttons are pushed for five seconds while in music mode, the controller will automatically exit the mode.

No other buttons will function while in music mode except for the 4 buttons on the face of the controller (buttons 1, 2, 3, and 4).

1. Change track: Push once to change the track, (up to six times). Push again to shuffle all tracks (confirmed by the shuffle all sound). Push again to turn off the music but keep the sound effects (confirmed by the music off sound). Push again to turn all sounds off (confirmed by the all sound off sound). Push again to start over again from the beginning.

2. Change Volume: To change volume first enter music mode, then Push button (3) to increase volume or Push button (4) to decrease volume. (see Diagram)

### Speeder bike soundtracks

TITLE: "THE IMPERIAL MARCH"  
MOVIE: THE EMPIRE STRIKES BACK

TITLE: "BENS DEATH AND TIE FIGHER ATTACK"  
MOVIE: A NEW HOPE

TITLE: "IMPERIAL ATTACK"  
MOVIE: A NEW HOPE

TITLE: "THE ASTEROID FIELD"  
MOVIE: RETURN OF THE JEDI

TITLE: "EMPEROR'S THRONE ROOM"  
MOVIE: RETURN OF THE JEDI

TITLE: "THE STARS AWAIT"  
COMPOSER: DAVID PELLICCIARO

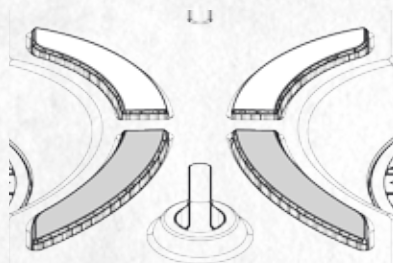

ENTER MUSIC MODE



Track  
1-7



Shuffle



Music  
off



Sounds  
off

CHANGE TRACK

VOLUME UP

1

3

2

VOLUME DOWN

4





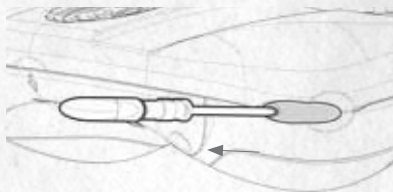

## LIGHTSABER SCREW DRIVER

This is the weapon of a Sith Lord, but it can also help you with simple tasks and repairs. It attaches to your controller and can be used to remove screws from the battery cover or to tighten the screw on the phone holder. It can also be used to remove parts on your Vessel if repairs are needed.

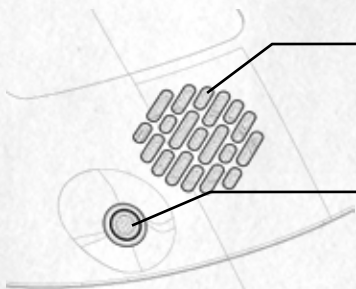

## SPEAKER

The controller's speaker will play every sound, including music, explosions, lasers, and more.



## NECK STRAP ATTACHMENT

For use with a lanyard, to help support the controller around your neck. (Lanyard not included)

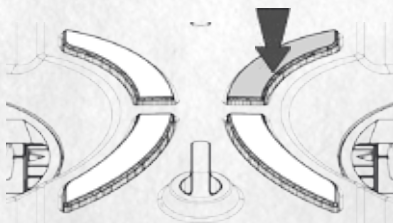

## CALIBRATE

If you experience a hard landing or crash your vessel begins to drift in a particular direction, you will need to land and recalibrate the gyro. On a flat level surface with the vessel's motors stopped, hold down the button for 2 seconds to calibrate the gyro.



## BAROMETRIC PRESSURE SENSOR ON/OFF (REPULSORS ON/OFF)

The barometric pressure sensor maintains the altitude of your Vessel above the ground, simulating the anti-gravity effect of a repulsorlift engine. This also lets you adjust your altitude incrementally during flight. Push the gimbal up or down and then release it, and your Vessel will hover at the new altitude.

Having the barometric pressure sensor activated enables your Vessel to perform an auto-start, but it also limits your angle of inclination and makes it less agile at performing stunts.

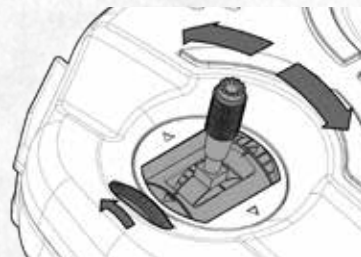

Barometric Pressure **OFF**



Barometric Pressure **ON**

## SMARTPHONE HOLDER

To use the smartphone holder, extend the pull tab on the top back side of the controller and pull it out until you hear a click.

Pull the end out and place your smartphone inside. It will close around your smartphone using spring pressure.

You can adjust the angle of your phone and lock it into place by tightening the screw at the base of the phone holder using the screwdriver in the side of the controller.

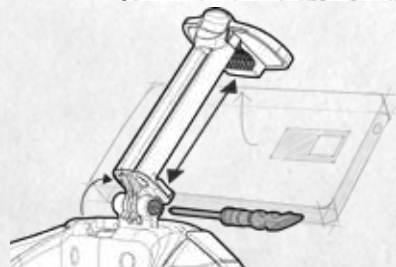

## LEARNING HOW TO FLY (T-MODE)

If this is your first time flying please read the following instructions, if you are an experienced pilot feel free to skip ahead to the next section.

T-Mode is a special flying mode intended to help ease new pilots into learning basic flight controls in a safe environment. To operate in T-mode you must first activate the repulsorlifts on the controller (see repulsorlifts on page 17). When in T-mode, your ship will help you to learn how to fly by moving in a controlled slow rate with added stability. T-mode allows you to familiarize yourself with the various functions of the control sticks before moving on to normal speed ratings.

### INVISIBLE CEILING AND FLOOR:

When flying upwards in T-mode, your altitude is automatically governed by an invisible ceiling at approximately 6 feet (2 meters). In addition to the ceiling there is also an invisible floor that prevents your ship from touching the ground creating a safe area to fly. In order to land your ship in T-Mode you will need to activate the auto landing sequence (See auto landing on page 24).

To enter T-Mode, hold down the speed change button for 3 seconds. You will know you have entered T-mode when all the lights around the power button turn blue. To exit T-mode simply press the speed control button once again and you will hear a beep and the LED speed indicator lights around the power button will return to red.

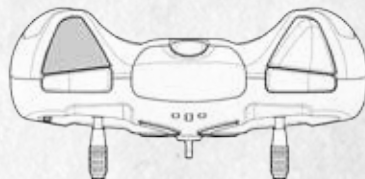
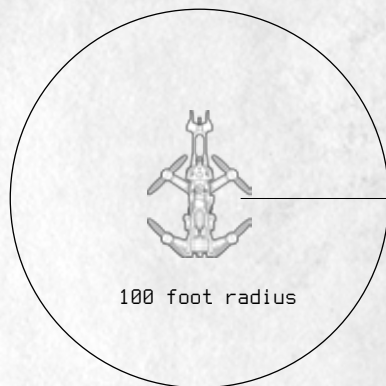

**T-MODE**



## PROTECTIVE CAGE

For beginner pilots we strongly suggest using the protective cage. Make sure you install your protective cage before flight. This cage protects the propeller blades, and the outside of the vessel from taking damage in when crashing into walls and other objects.

### INSTALLING THE CAGE:

To install the cage place the vessel in the cage with the central bar running from front to the back (not side to side) and with the 4 C shaped plastic connectors slid over each of the motor arms (see diagram a). Proceed to securely fasten the cage by pinching the 4 C shaped connectors with your thumb and forefinger until you feel a small snap indicating that the connector is locked in to the motor arm (see diagram b). Note: make sure the cage C connectors is all the way in the highest position (see diagram c)

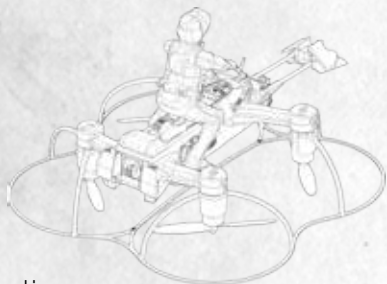

diagram c

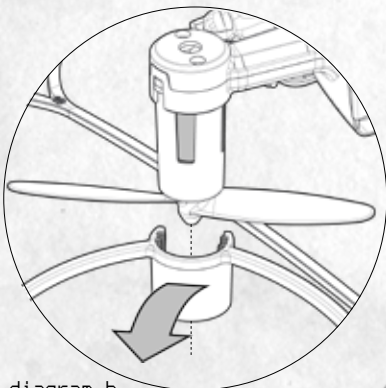

diagram b

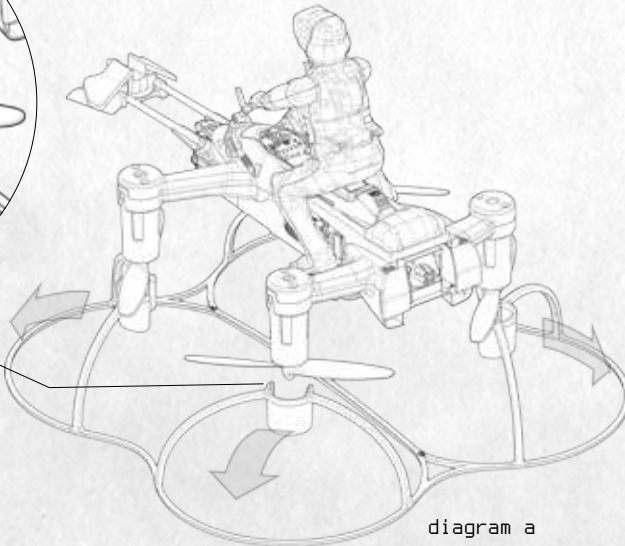

diagram a



## FOR MULTI PERSON PLAY:

Before beginning, ensure that all ships and controllers are powered off. Make sure that no other 2.4GHz devices are in the area.

Each person must sync their ship individually at different times in order to avoid interference. Follow steps 1 to 3 above, making sure to keep away from others while ensuring that no one else is syncing at the same time.

After one player syncs their ship, it should be left on until all players have finished syncing their own ships.

Should a mistake or interference occur, all players should turn off their controllers and ships for 60 seconds and begin the process again.



**SPEED 1**



**SPEED 2**



**SPEED 3**



**T-MODE**

**RED LEDS-** Stop flashing when synced to ship

## PREPARING FOR FLIGHT

Verify that the controller has 4 AA batteries and the Vessel's battery is fully charged.

Make sure your Vessel and controller are both powered on.

Operate in a large space, with an open radius of at least 100 feet.

Check the environment to ensure it has no obstacles or a river. Set your Vessel on a clean flat surface before takeoff.

**DO NOT FLY YOUR VESSEL DURING RAIN, SNOW, OR HEAVY WINDS.**

## CHECKLIST

- 4 AA batteries
- Power on
- 100 feet radius
- No rivers
- Good weather



**100  
FEET**



## FLIGHT CONTROL

These are the basic flight functions for your Vessel. While learning to fly it is best to begin inside a large space, at least until you get used to the basics. Once you master your Vessel you can tackle more advanced maneuvers.

Practice makes perfect! Once you have these steps mastered, move to the next level.



Move the Throttle up to increase the speed of the motors and the Speeder Bike will rise up.

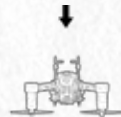

Move the Throttle down to decrease the speed of the motors and the Speeder Bike will descend.



Move the Throttle stick left and the Speeder Bike will rotate left.



Move the Throttle stick right and the Speeder Bike will rotate right.



Move the Direction Control up and the Speeder Bike will move forward.



Move the Direction Control down and the Speeder Bike will move backward.



Move the Direction Control left and the Speeder Bike will bank to the left.



Move the Direction Control right and the Speeder Bike will bank to the right.



## FLYING TIPS

Operate your Vessel in a wide space. Ideally, the space will have at least a 100 foot radius.

If you are flying your Vessel with others, make sure spectators are located behind you.

For best performance, it is recommended that you operate the Vessel during zero wind conditions, as wind can greatly affect flight performance.

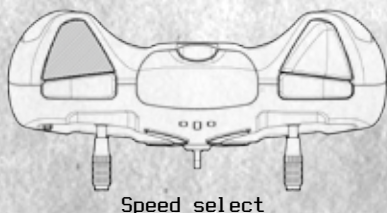
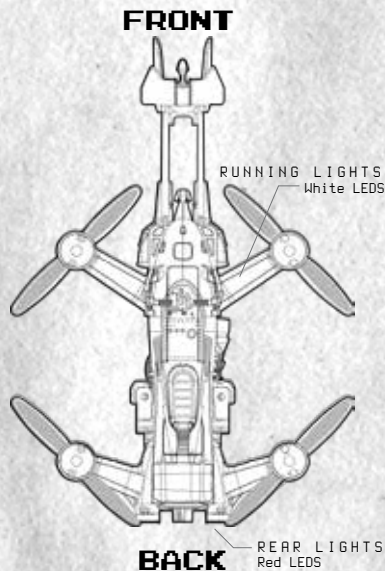

## RECOGNIZING THE FRONT AND BACK OF THE VESSEL

Even though your Vessel has four rotors, it still has a front or forward-facing direction, and a back or backwards-facing direction.

white LED running lights will help you easily the front of the vessel. The rear of the Vessel can be easily identified by the red LED lights

NOTE: The front of the Vessel displays white LEDs. The back displays red LEDs.

VOB 7UN↓ VOV EJ1W4E

## SPEED SELECT BUTTON

Your Vessel has 3 speed settings: SLOW, MEDIUM and HIGH. The default setting is SLOW.

Change the speeds using the speed select button, select your speed according to your flying skill.

The speed select button is located on the top left side of the controller





**SPEED 1**



**SPEED 2**



**SPEED 3**



**T-MODE**

## SPEED CHANGE

When the controller is powered on, it will always start on speed 1. If the controller was in Speed Mode 3 before turning it off, it will return to Speed Mode 1 when it is turned back on.

Push the button to change speeds between Modes 1-3. If you are in Speed Mode 3 and press the button, you will cycle over to Speed Mode 1.

Flying speed is indicated by the LEDs surrounding the controller's power button.

**RED** - Synced to Ship

**BLUE** - Sync to phone

(with or without being synced to Phone)

## TURN ON/OFF LED'S AND LASERS



**1 BEEP**

1 seconds

**on/off**

white LEDs

**1 BEEP**

4 seconds

**on/off**

lasers

Push the button for 1 second (you will hear 1 beep) to turn on/off the white LEDs that illuminate your ship. (The red LEDs in the rear of your ship will remain on.)

Hold down the button for 4 seconds (you will hear 2 beeps) to turn on/off your ship's lasers. Note that when the lasers are activated, the IR transceiver will be deactivated, and vice versa.

## EMERGENCY STOP

Simultaneously push the left and right gimbals (control sticks) down and in to activate the emergency stop. This will cut all power to the motors and the ship will fall to the ground. This is only to be used in case of emergency, as the ship may get damaged when it hits the ground.



## AUTO-START/AUTO-LAND

When repulsorlifts are activated, push button once when on the ground to auto-start. Push button for 2 seconds when in the air to auto-land.

### AUTO-START:

Auto-start only works when the barometric pressure sensor is activated.

If barometric pressure sensor is activated, auto-start will work only if the left stick (gimbal) is in the center position.

The right control stick will function normally during the auto-start sequence, allowing you to control the direction of your take-off.

After auto-start button is pressed, motors will activate and the vessel will take off and hover at a height of approximately 6 feet.

If the left stick (gimbal) is pushed up or down, the auto-start will be canceled and normal controls will resume.

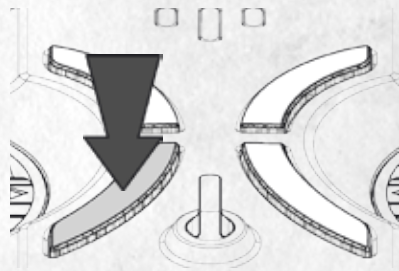

### AUTO-LAND:

Push button for 2 seconds while in the air to auto-land.

When auto-land is pushed it will override the sticks (gimbals) control, unless the left stick (gimbal) is moved up or down during the auto-land operation. The right control stick will function normally during the auto-land sequence, allowing you to control the direction of your descent. If the barometric pressure sensor is off (for a manual take-off), then the left stick must be moved all the way down before the blades will unlock and allow you to control the throttle manually.

## COMBAT FLIGHT

The 74-Z Speeder Bike is essentially a repulsorlift engine attached to a seat and a laser cannon, making it one of the most efficient speed-to-weight vehicles ever devised within the Empire. This maneuverability is your key to defeating more heavily-armed opponents.



## CLOCKWISE ROLL (A)



Push the right trigger button while flying and your Vessel will perform a 360-degree roll in a clockwise motion while continuing its current movement. If the Vessel is flying forward it will continue to move forward as it performs the roll, and will perform similarly with any directional movement.

## COUNTER CLOCKWISE ROLL (B)



Clockwise roll (A)

Push the left trigger button while flying and your Vessel will perform a 360-degree roll in a counterclockwise motion while continuing its current trajectory.

## WEAPONS FIRE (C)



counter clockwise roll (B)

Your Vessel comes pre-installed with infrared battling transmitters and receivers as well as laser receivers. Only one type of weapon can be used at a time, meaning you can either fight with infrared weapons or with lasers.

Push the button to fire the weapon. Let go and push again to fire a second time.

The weapons button activates either the infrared LED or the lasers, depending on which weapons system is equipped. If lasers are activated, the infrared LED transmitter and receiver will be deactivated. If the infrared LED transmitter is activated, the laser receivers will be deactivated.

When weapons are fired, you will hear a laser sound from the controller's speaker (or headphones if plugged in).

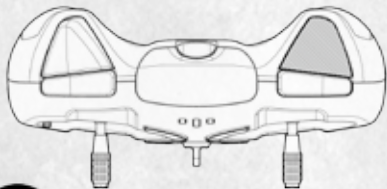

Weapons Fire (C)



## BATTLING

When battling with your vehicle it is best to fly outside in a wide open space of about 200-300 feet, in an open field with no obstruction such as trees, houses, open water or power lines. When battling indoors it is recommended to do so in a very large open area such as a gymnasium or sports center with high ceilings and no obstructions.

## IR BATTLING

With IR battling, the infrared transmitters in the front of the Vessel will send a signal and the infrared receiver beneath the Vessel will register a hit.

IR battling is relatively easy because it sends a wide signal and the receiver points down underneath the Vessel. If you aim anywhere beneath your target vessel from a range of less than 2-3 meters, you will most likely score a hit.

A few things to note about IR battling:

Sunlight greatly reduces the distance at which an IR signal can travel. Battling outside in daytime means that you will need to be especially close to your opponent to score a hit on.

When battling indoors, IR signals can bounce off of walls (especially white walls). You can sometimes achieve a hit even if you weren't directly aiming at your opponent if you fire using the right angle.

When IR battling, you will not be able to battle with any Propel Star Wars ships that are set to laser battling mode.

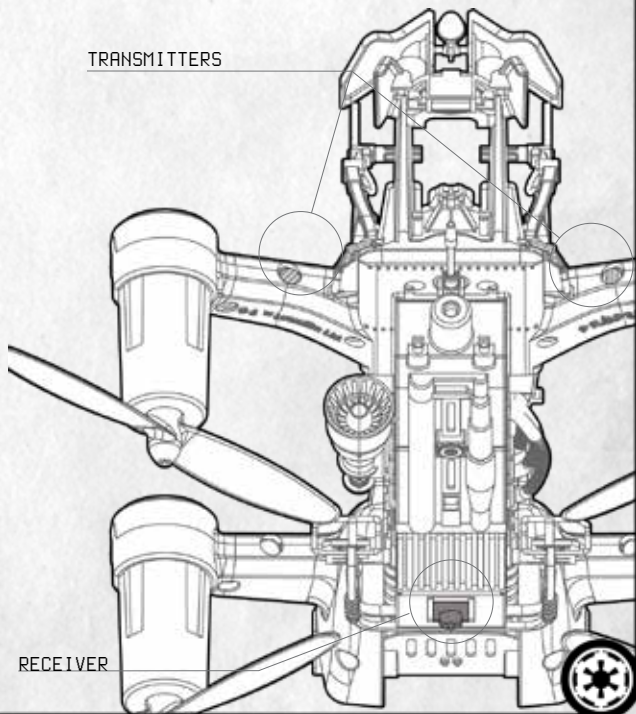

TRANSMITTERS

RECEIVER

## LASER BATTLING (UPGRADE)

Laser battling is a more advanced method of battling other propel Star Wars drones, and therefore is vastly more challenging. Each Vessel is equipped with laser receivers in the front and in the back.

Receivers must be hit directly with an opposing Vessels lasers in order to score a hit. The recommended distance for laser battling is between 0.5 and 3.5 meters. It is possible, though very difficult, to hit an opposing Vessel from a greater distance.

A few things to note about laser battling:

Your lasers must be correctly installed and adjusted if you hope to shoot straight. If your lasers aren't properly adjusted it will be difficult to aim. The calibration tool included with your laser upgrade kit can be used to adjust the lasers.

Lasers should be fired from a short distance (between 0.5 and 3 meters).

If you are using lasers, you will not be able to battle with any ship that is equipped for IR battling.

Lasers can be used day or night but are best seen in the dark or while using a smoke or fog machine.

To access laser battling you will need to purchase a Propel Speeder bike laser upgrade kit, sold separately at fine retailers or at [www.propelsw.com](http://www.propelsw.com)

UPGRADE

THE EMPEROR NEEDS YOU!



7A0W 01E JEV  
7M0VJ N40Z



## LIFE LED'S:

When the controller's power is turned on, all 3 life LEDs will flash. Once synced, all 3 life LEDs will glow red.

Reactions to being hit: When the Vessel is hit by an opponent, it will react and alter its flight. No additional hits can be inflicted on the Vessel during this time.

### FIRST HIT:

The Vessel will continue on its current trajectory, but will rock back and forth two times left to right in a fluid motion. The controller will vibrate for 3 seconds and play a unique sound effect through the speaker. During this time, the 3 life LEDs will flash and the Vessel will not react to any other laser hits. At the end of the maneuvers, only 2 life LEDs will remain lit, and the player who has struck your Vessel will receive a notification through their controller of a successful hit.

### SECOND HIT:

Similar to first hit, but the movement will be more aggressive. The 3 life LEDs will flash and the Vessel will not react to any other laser hits. At the end of the rocking, only 1 life LED will remain lit, and the player who has struck your Vessel will receive a notification through their controller of a successful hit.

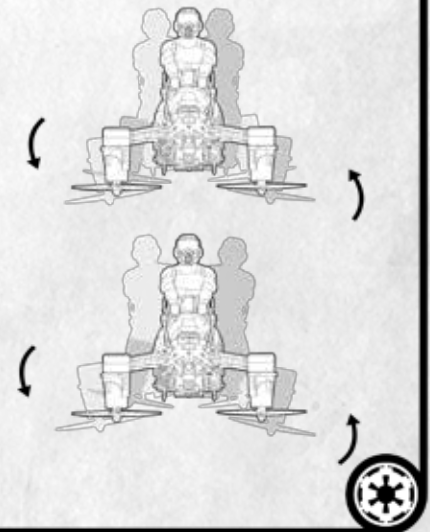
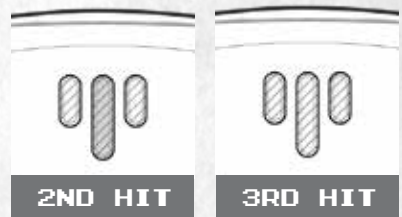
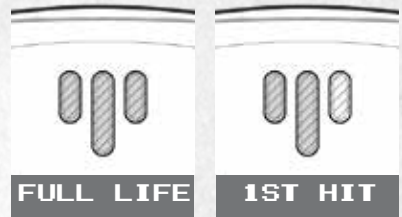

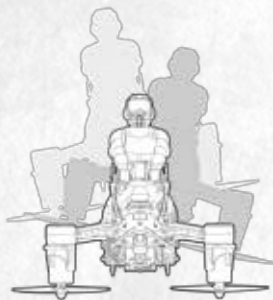
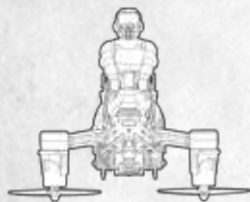

### THIRD HIT AUTO LANDING:

This is the final hit in battle. When you have been hit a 3rd time your vessel will enter into auto-land mode and descend in a downward spiral.

### TAKING OVER LANDING SEQUENCE

Pulling your left throttle stick all the way down during auto landing sequence will activate user controlled landing mode. This feature allows you to take control of your direction while you fall. This may be used to avoid hitting an obstacle.

### IN ADVANCED MODE (REUPULSORLIFT DEACTIVATED);

When descding all the controls will remain active except the throttle, allowing you to move freely and create your own crash landing pattern.

### GAME RESET

During a 3rd hit auto-landing you will have no access to throttle as your vessels descends and stops. During this time, the 3 life LEDs will flash and the ship will not react to any other laser hits.

All flight controls will return to normal after the 10 seconds are up. 3 new life LEDs will turn your controller signifying that you may re-enter the battle.

01↓E00↓ ↓EM V1Z017V ↓EM7V 1N HEEKON K07 701W





## NOTES

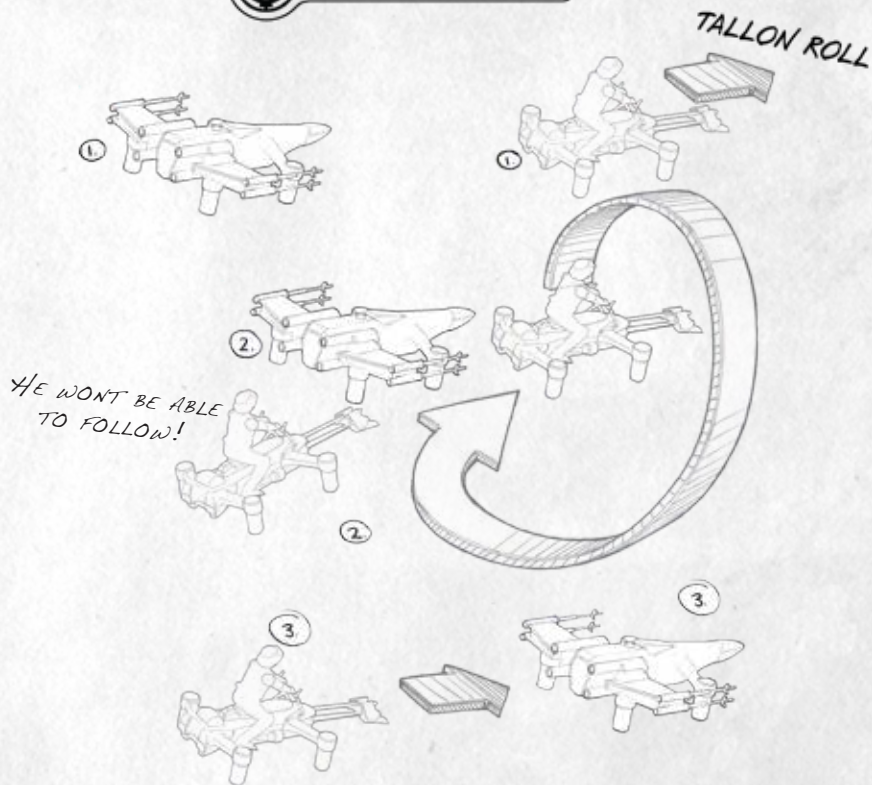

NAMED AFTER ADAR TALLON, IMPERIAL DEFECTOR WHO BRAVELY AIDED THE ALLIANCE, THE TALLON ROLL IS A TRICKY TECHNIQUE THAT'S EXECUTED WHEN AN ENEMY PILOT IS APPROACHING FAST FROM THE REAR.

IF THE PILOT LEVELS OUT AND PULLS UP WHILE ROLLING AWAY FROM THE DIRECTION OF THE TURN, THEY CAN SLIP BACK IN BEHIND THE ENEMY WITH NO LOSS OF DISTANCE OR SPEED.





## NOTES

*DROP BACK AND ATTACK*

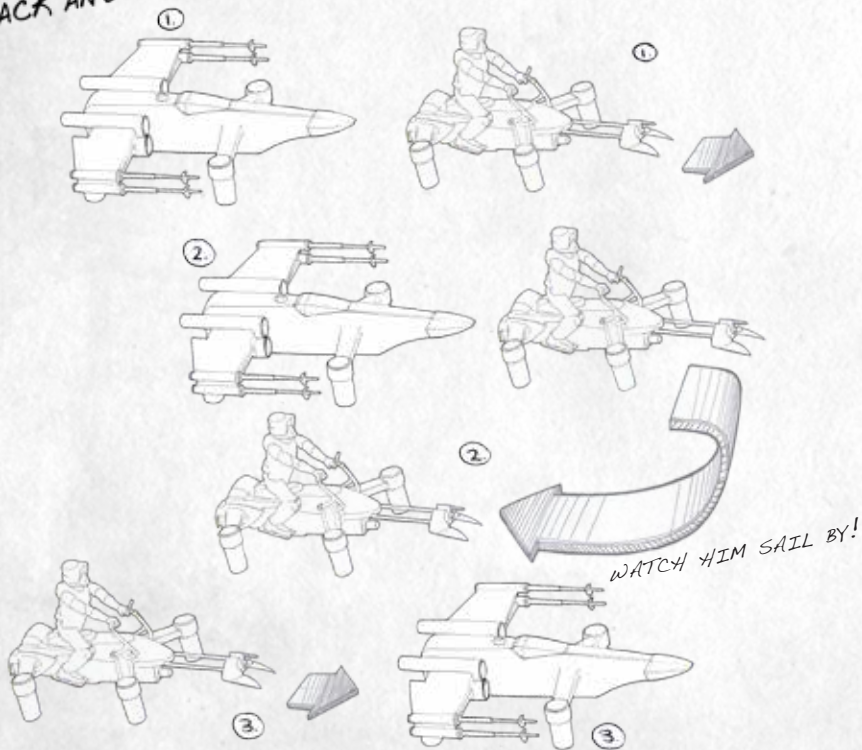

*CUT YOUR THROTTLE AND DROP BENEATH THE ELEVATION OF A CHASING ENEMY.  
PROTECT YOUR SPEEDER BIKE'S VULNERABLE UNDERBELLY WHILE MANEUVERING  
INTO ATTACK POSITION!*







## NOTES

### CIRCULAR STRAFE

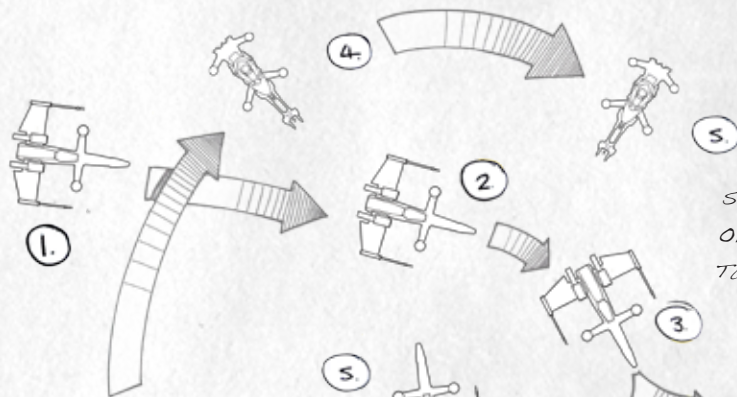

STAY IN FRONT  
OF YOUR ENEMIES  
TURN



WATCH FOR  
THE  
COUNTER TURN!

EASE INTO SIDE  
SLIP-GET ON  
TARGET

WHEN YOU'RE IN THE RIGHT SPOT, USE A COMBINATION OF YOUR YAW AND AILERON (SIDEWAYS STRAFE) CONTROLS TO STRAFE IN A FULL CIRCLE AROUND YOUR OPPONENT. IF YOU TIME IT RIGHT, YOU CAN DEVASTATE REBEL ATTACKERS.





## NOTES

SMUGGLER'S  
REVERSE

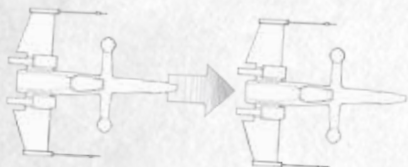

1.

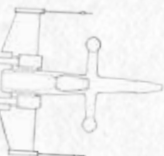

2.



1.



2.

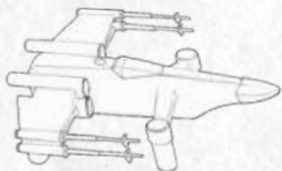

DROP BELOW TO ATTACK  
YOUR ENEMY'S BELLY

PREY TURNS PREDATOR

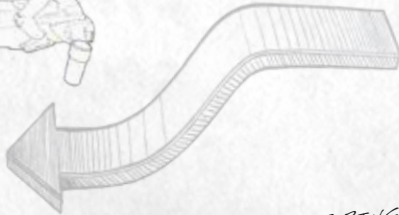

180 DEGREE  
YAW TURN

BEAT REBEL PILOTS AT THEIR OWN GAME BY MASTERING THIS MOVE. MAKE A 180 DEGREE TURN AT FULL THROTTLE, RESULTING IN A RAPID DIRECTIONAL CHANGE WITH ALMOST NO TURNING ARC. YOU CAN THEN SURPRISE YOUR ENEMY WITH A DEVASTATING ATTACK.





## NOTES

### REVERSE THROTTLE HOP

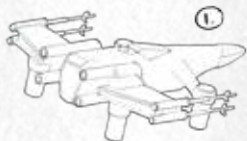

1



1

NOSE UP! PROTECT  
YOUR BELLY



2



2



GET ON HIS TAIL  
QUICK!

3



3



WHEN A REBEL IS CLOSING IN FROM YOUR REAR, EXECUTE A JUMPING HOP, BY PULLING UP AND EASING OFF ON YOUR THROTTLE, LOSING YOUR FORWARD SPEED AND DROPPING BACK BEHIND THEM. IF YOU DO IT RIGHT, YOU'LL FIND YOURSELF IN A POSITION FOR A KILL SHOT.



## **SPEEDER BIKE WARNING:**

Your speeder bike is designed for INDOOR or OUT-DOOR use . The speeder bike blades revolve at high speeds and can cause harm to the user, spectators, and animals.

Stand clear of the Vessel to reduce the risk of getting into its flight path. Warn spectators that you will be flying your Vessel so that they can remain aware of its position. Before flying, inspect the Vessel s rotor blades to ensure they are securely fastened.

### **WARNING!**

Choking/Cutting Hazard: Small parts/sharp rotor blades.

Keep hands, hair and loose clothing away from the propeller when the power switch is in the ON position.

Turn off the controller and Vessel s power switches when not in use.

The included charger is built specifically for your speeder bike s Li-Poly battery. Do not use it to charge any other battery.

New alkaline or rechargeable 1.5v batteries are recommended for maximum performance.



## **BATTERY WARNINGS RECHARGEABLE BATTERY:**

This Vessel uses a Li-Poly rechargeable battery. If the battery no longer stays charged, dispose of it properly according to local disposal requirements.

### **CONTROLLER BATTERIES:**

Controller requires 4 AA batteries (not included). Please read the important battery safety warning below.

Do not mix alkaline, standard (carbon-zinc) and rechargeable batteries (Nickel Metal Hydride).

Do not mix old and new batteries.

Non-rechargeable batteries are not to be recharged.

Rechargeable batteries are to be removed from the item before being charged (if removable).

Rechargeable batteries are only to be charged under adult supervision.

Exhausted batteries should be removed immediately and must be recycled or disposed of properly according to state or local government ordinances and regulations.

The supply terminals are not to be short-circuited.

Only batteries of the same or equivalent type as recommended are to be used.

Batteries are to be inserted with the correct polarity (see inside booklet for diagram).

Do not dispose of batteries in a fire as batteries may leak or explode.

## **CARE AND MAINTENANCE**

Always remove the batteries from the controller when it is not being used for an extended period of time.

To clean, gently wipe the controller and Vessel with a clean damp cloth.

Keep your equipment away from direct heat or sunlight.

Do not submerge the controller or Vessel in water. This can damage the unit beyond repair.

Parental guidance recommended when installing or replacing batteries.



## FCC PART 15 C NOTICE

CAUTION: Changes or modifications not expressly approved by the party responsible for compliance could void the user's authority to operate the equipment.

NOTE: This equipment has been tested and found to comply with the limits for a Class B digital device, pursuant to Part 15 of the FCC Rules. These limits are designed to provide reasonable protection against harmful interference in a residential installation. This equipment generates, uses and can radiate radio frequency energy and, if not installed and used in accordance with the instructions, may cause harmful interference to radio communications. However, there is no guarantee that interference will not occur in a particular installation. If this equipment does cause harmful interference to radio or television reception, which can be determined by turning the equipment off and on, the user is encouraged to try to correct the interference by one or more of the following measures:

- Re-orient or relocate the receiving antenna.
- Increase the separation between the equipment and receiver.
- Connect the equipment into an outlet on a circuit different from that to which the receiver is connected.
- Consult the dealer or experienced radio/TV technician for help.

This device complies with Part 15 of the FCC Rules. Operation is subject to the following two conditions :

- (1) This device may not cause harmful interference, and
- (2) this device must accept any interference received, including interference that may cause undesired operation.

This device complies with FCC and IC radiation exposure limits set forth for general population (uncontrolled exposure). This device must not be collocated or operating in conjunction with any other antenna or transmitter.



**INDUSTRY CANADA NOTICE****CANADA ONLY**

This device complies with Industry Canada licence-exempt RSS standard(s). Operation is subject to the following two conditions: (1) this device may not cause interference, and (2) this device must accept any interference, including interference that may cause undesired operation of the device.

Le présent appareil est conforme aux CNR d'Industrie Canada applicables aux appareils radio exempts de licence. L'exploitation est autorisée aux deux conditions suivantes : (1) l'appareil ne doit pas produire de brouillage, et (2) l'utilisateur de l'appareil doit accepter tout brouillage radioélectrique subi, même si le brouillage est susceptible d'en compromettre le fonctionnement.

**WEEE Directive & Product Disposal**

At the end of its serviceable life, this product should not be treated as household or general waste. It should be handed over to the applicable collection point for the recycling of electrical and electronics equipment, or returned to the supplier for disposal.

**Internal/Supplied Batteries**

This symbol on the battery indicates that the battery is to be collected separately. This battery is designed for separate collection at an appropriate collection point.



starwars.com  
© & ™ Lucasfilm.Ltd

Conforms to safety requirements of ASTM, CPSIA, FCC and EN71.

Made in China

©2016 Rooftop Brands™ All rights reserved

Tel: + 1(877) 353 www.propelsw.com



## LIMITED 90-DAY WARRANTY

## NORTH AMERICA

ROOFTOP BRANDS™ warrants to the original consumer that this product is free from any electrical or mechanical defects for a period of 90 DAYS from the date of purchase. If any such defect is discovered within the warranty period, ROOFTOP BRANDS™ will repair or replace the unit free of charge upon receipt of the unit, Shipped postage prepaid and insured to our warranty center. The warranty covers normal consumer use and does not cover damage that occurs in Shipment or failure that results from alterations, accident, misuse, abuse, neglect, wear and tear, inadequate maintenance, commercial use or unreasonable use of the unit. Removal of any parts/components voids all warranties. This warranty does not cover cost of repairs made or attempted outside by third-party individuals or companies. Any applicable implied warranties, including warranties of merchantability and fitness, are hereby limited to 90 DAYS from the date of purchase. Consequential or incidental damages resulting from a breach of any applicable express or implied warranties are hereby excluded. Some states do not allow limitations on the duration of implied warranties and do not allow exclusion of incidental or consequential damages, so the above limitations and exclusions in these instances may not apply.

## REPAIR/REPLACE PRODUCT

If your product begins to malfunction or stop working, immediately call or email our warranty center at the phone/email listed below. If it is determined that a return is necessary, our warranty department will issue you an RMA number/form and an address to the nearest return center for Shipping the product to. IMPORTANT NOTICE: We will reject all returns that are not accompanied by an issued RMA form and number so make sure to contact our warranty center before attempting to return your product!

## PREPARATION FOR SHIPPING

### YOUR PRODUCT

Please repack your product in a durable box, preferably in the original carton, and send it prepaid, and adequately insured.

Include the RMA form that was issued by our warranty department along with your daytime telephone number and email address (if available) inside the Shipping carton. If your warranty has expired, contact our warranty center for charged service.

For further information please send all inquiries to [customerservice@rooftopbrands.com](mailto:customerservice@rooftopbrands.com)

### IMPORTANT NOTICE!

DO NOT ATTEMPT TO Ship YOUR PRODUCT BACK WITHOUT FIRST CONTACTING OUR WARRANTY DEPARTMENT AT:

ROOFTOP BRANDS™  
WARRANTY REPLACEMENT  
DEPARTMENT

TEL: + (1) 949-566-9573  
[customerservice@rooftopbrands.com](mailto:customerservice@rooftopbrands.com)







PROPEL