

CDMA Cellular Wireless Phone User Manual



Model: L100 (Voice, SMS & Data)

Edited on Aug.19, 2009

Table of Contents

1	PHONE OVERVIEW	5
2	BASIC FUNCTIONS	6
3	BASIC OPERATIONS	7
3.1	POWER ON/OFF	7
3.1.1	Power On	7
3.1.2	Power Off	7
3.2	MAKE A CALL	7
3.3	RECEIVE A CALL	7
3.4	END A CALL	7
3.5	SPEED DIAL	7
3.6	BATTERY USING NOTES	7
4	IDLE SCREEN	7
5	PHONE MENU	8
5.1	MAIN MENU	8
5.2	CONTACTS (PHONEBOOK)	9
5.3	MESSAGES	11
5.4	RECENT CALLS	12
5.5	TOOLS	13
5.6	SETTINGS	14
6	KEYPAD LOCKING	17
6.1	LOCK KEYPAD	17
6.2	MODIFY KEYPAD LOCKING CODE	18
7	DATA SERVICE	18
8	TECHNICAL SPECIFICATIONS	18
9	QUICK TROUBLESHOOTING GUIDE	19

Introduction

Congratulations on your purchase of the CDMA Cordless Phone (Hereinafter referred to as Phone). The Phone has been designed to operate with the latest digital communication technology - Code Division Multiple Access (CDMA). The CDMA technology has many advanced features and provides excellent voice quality.

The Phone has advanced features as follows:

- Large, easy to read, backlight LCD with status icons
- Choice of 13 ring tones and power On/Off music
- Two-way SMS, voice mail and caller ID
- User friendly Keypad
- Long battery stand-by and talk time
- Menu driven interface for easy operation and configuration
- Last number redial
- Adjustable ring and voice volume
- AC power supply
- Built-in antenna
- Hands-free
- Call privacy is also supported by CDMA technology
- USB data cable is provided for L100
- Easy service and repair
- Subscriber call charge meter



This user guide provides information on the use and operation of your Phone. Kindly read all the information contained in this user guide carefully prior to using the Phone. This will help you get the best performance and shall prevent any unintended damage to the Phone. Check the contents of the box as per the packing list and report any discrepancies immediately to the store from where Phone has been purchased.

Do's & Don'ts

- Do not clean the Phone while in operation. Before attempting to clean the Phone, turn the Phone off, disconnect the external power adapter and take out the battery. Use a Damp cloth for cleaning. Do not use liquid or aerosol cleaners.
- Only use the battery and the power adapter provided with the Phone. The Phone might get damaged if other accessories are used. This will also void the warranty.
- It is highly recommended to fully charge the battery before initial use. The battery might have been discharged during storage and delivery.
- Do not use car device to charger battery. It may lead to electric shock or damage to Phone.
- Do not throw away battery. Batteries are not to be disposed to fire. It may explode or catch fire.
- Do not attempt to change the security codes or components. User is responsible for any consequences arising from such attempt.
- Avoid shock or impact. Rough handling can cause damage to the Phone cabinet and internal

CDMA cordless Phone

circuits.

- Do not paint.
- During lightening do not touch power plug or Phone line. This can cause Electric shock, even death.
- Your Phone is to work with 100-265V AC. Check the voltage before connecting.
- Do not plug many power cords in the outlet.
- Do not touch the plug with wet hands. Always grasp and pull the plug, not the cord. Do not put heavy things on the power cord or bend it too much.
- Do not take out the battery while Phone is on.
- If the Phone is not working for any reason, do not attempt to repair it yourself. The Phone should be serviced by qualified service personnel only.
- Place the Phone and the power supply in a properly ventilated place.
- Do not place the Phone near high temperature objects, under direct sunlight, near source of water, near fire or near inflammable and explosive materials.
- Do not place any article over the Phone.
- Place the Phone in a dry place and do not expose to moisture.
- Place the Phone away from any other electronic device like TV and Radio to avoid interference.
- For a better reception, do not place the Phone in a building with iron or metal roof.
- Hospitals or health care facilities may use an equipment which is sensitive to Radio Frequencies. Please ensure that your Phone is turned "OFF" while in the vicinity of such facilities.

1 Phone Overview

Figure 1 depicts the keypad of the phone.

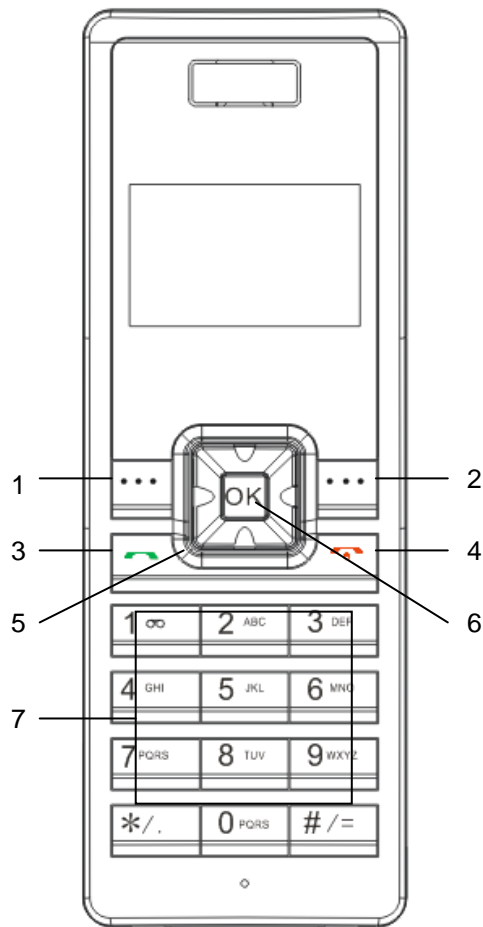

1. Left Soft Key
2. Right Soft Key
3. SEND key
4. POWER ON/OFF & END key
5. Direction Key
6. OK Key
7. Number Keys

Figure 1 Phone

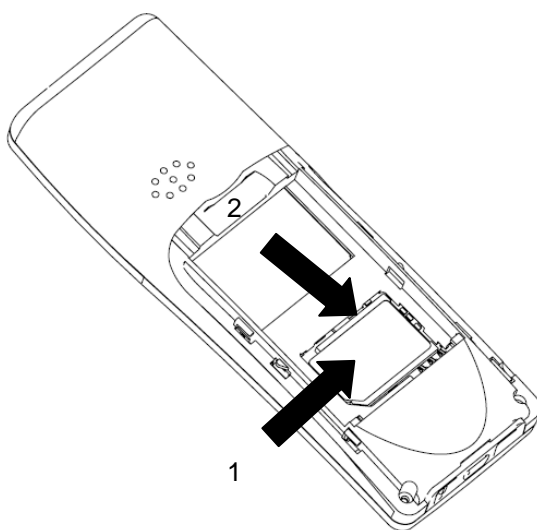

1. Insert the R-UIM card
2. Plug in the battery

Figure 2 Phone

2 Basic Functions

The following table lists the basic functions of the Phone.

Table 1 List of Basic Functions

Functions	Remark
Voice Calls	Support caller ID for incoming calls
Call Barring	Outgoing calls/Incoming calls
Contact	Store up to 200 entries in Phone memory And up to 200 entries in R-UIM card (if used)
Recent Calls	Records for incoming calls, outgoing calls, and missed calls (total 30 entries)
Phone Setting	Sounds, Display, Security, Network, Language (English only), Call Forward, Call Waiting
Tools	Schedule, Alarm Clock, Calculator
Phone Status	Software and Hardware Versions and etc
Message	Sending/Receiving SMS 200 entries in the Phone and 200 in R-UIM card (if used)
Battery Management	Battery Charging, Battery Capacity Indication
AT Commands	Standard
CDMA 1X Data Service	Up to 153.6kbps (only for L100 Phone)
FM	Support

3 Basic Operations

3.1 Power On/Off

3.1.1 Power On

Press the Power On/Off Key for 3 seconds to power on the Phone. The phone is in standby mode and is ready to use.

3.1.2 Power Off

Press the Power On/Off Key for 3 seconds to power off the Phone.

3.2 Make a Call

Enter a destination number you wish to call, then press “SEND” Key. (Note: To modify digits you enter, you can press “Right Soft” Key to delete wrong digits first and then enter new digits).

Once the call is connected, the Phone’s screen will display the number you have dialed, and the time duration of the call.

3.3 Receive a Call

When there is an incoming call, the Phone will ring and display the number of the incoming call (if the number is available). You can press “SEND” Key to answer the incoming call. The ring tone and its volume can be changed in the setting menu.

3.4 End a Call

Press “END” Key to end a phone call.

3.5 Speed Dial

User can set up speed dial numbers.

- Save the Phone number in the contact list of Phone ;
- Set up a speed dial number (any number from 2 to 9) through menu “*Main menu/contacts/speed dial*”;
- Choose a phone number from contact list , Press “SELECT” ,then save it;
- When using speed dial function, press speed dial number (any number from 2 to 9) then #, and “SEND” Key .

3.6 Battery Using Notes

- Li+ rechargeable batteries should be used in the Phone.

4 Idle Screen

Power on the phone. Where’s signal, the Phone will display the following idle screen:



Figure 2 Idle Screen

5 Phone Menu

The idle screen displays: CDMA signal strength, battery level, date and time, name of local CDMA operator, programmable banner, and some other useful information: for example, if you have unread SMS, the message icon will show up.

5.1 Main Menu

At the bottom of the screen (see Figure 4), there is an area called soft Key area. You will see two soft Keys: Menu and Contact. Press Left Soft Key to open main menu. Main menu contains the following sub-menu items:

- 1) Contacts (Phonebook)
- 2) Messages
- 3) Recent Calls
- 4) Tools
- 5) Settings

The following diagram depicts menu tree:

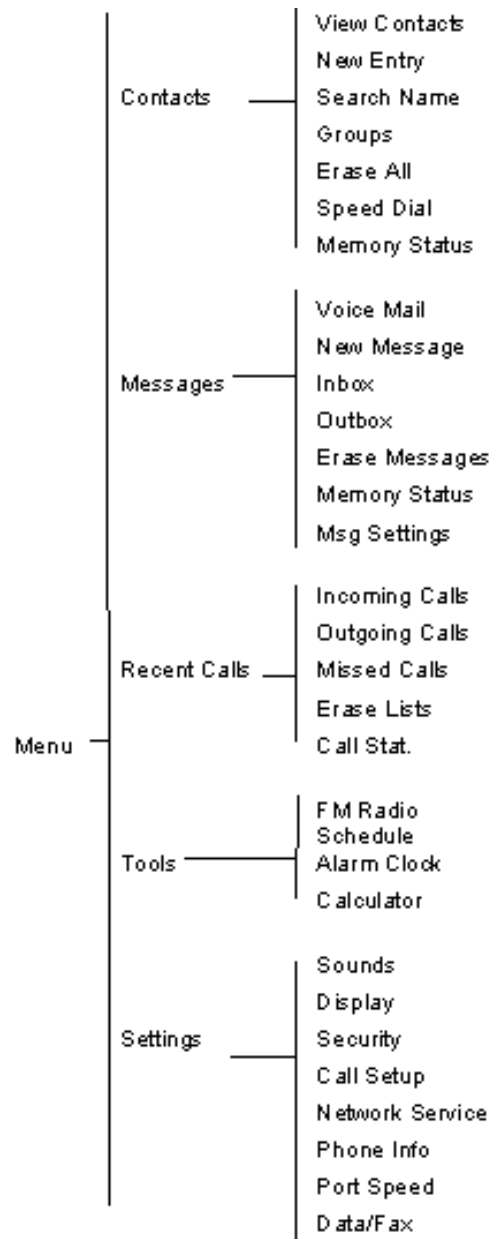

Figure 3 Menu Tree

5.2 Contacts (Phonebook)

Phonebook can be used to store contact's name , phone numbers, address, email address and internet address. You can store up to 200 Phonebook entries to Phone memory. If your Phone supports R-UIM card, you can also store contact data in R-UIM card.

Phonebook menu is depicted in the following diagrams:

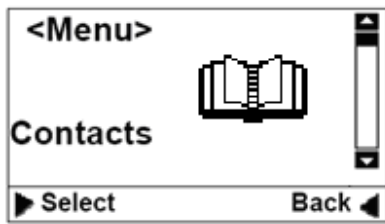

Figure 4 Phonebook: Menu -1

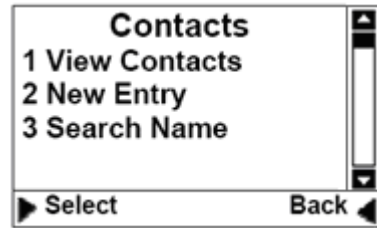

Figure 5 Phonebook: Menu -2

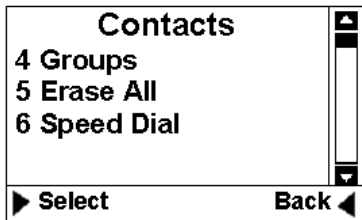

Figure 6 Phonebook: Menu -3

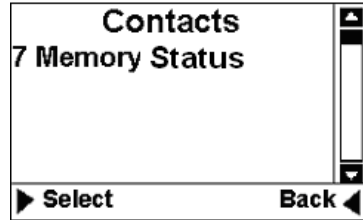

Figure 7 Phonebook: Menu -4

- 1) View Contacts: You can use this menu item to browse all Phonebook entries stored. For each selected Phonebook entries, you can edit, erase the contact, send message and make phone calls to it.
- 2) New Entry: You can use this menu item to add a new entry to the Phonebook:

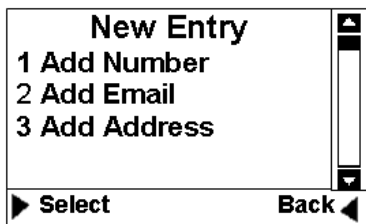

Figure 8 Phonebook: New Entry -1

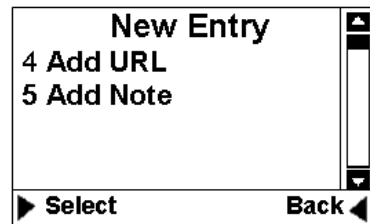

Figure 9 Phonebook: New Entry -2

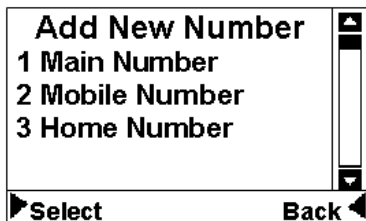

Figure 10 Phonebook: New Entry -3

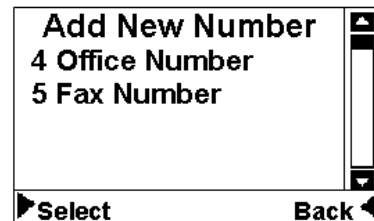

Figure 11 Phonebook: New Entry -4

- 3) Search Name: Using this menu item, you can search an entry by entering the name of the contact you want to find.
- 4) Groups: You can use this menu item to categorize Phonebook entries into five different groups: family, friends, colleagues, business and classmates:

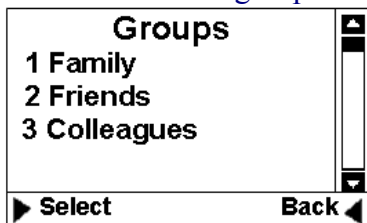

Figure 12 Phonebook: Group - 1

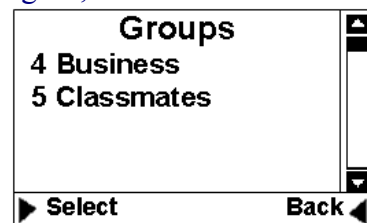

Figure 13 Phonebook: Group - 2

- 5) Erase All: Using this menu item, you can delete all Phonebook entries from Phone memory. or R-UIM card memory:

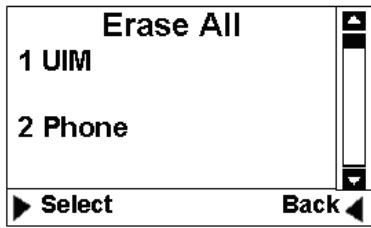

Figure 14 Phonebook: Erase All

- 6) Speed Dial: This feature is used to set up speed dial. You can add speed dial number, remove one or all speed dial numbers.
- 7) Memory State: This menu can display the memory status of the Phone and R-UIM card.

5.3 Messages

The Message menu can be used to create SMS messages, send messages, view received messages, delete stored messages, extract and store Phone numbers from messages, reply and forward messages. You can store up to 200 messages to Phone memory and 200 messages to R-UIM card.

Messages' main menu and menu tree Message are shown as below:

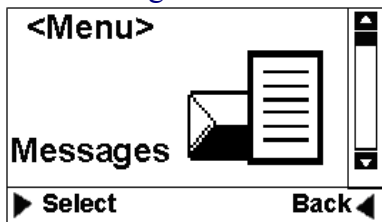

Figure 16 Message: Menu-1

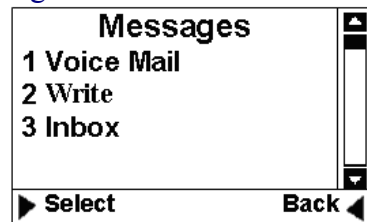

Figure 17 Message: Menu-2

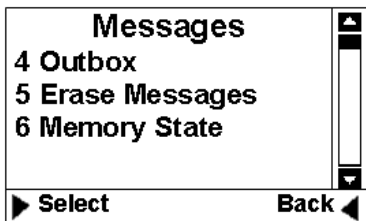

Figure 18 Message: Menu-3

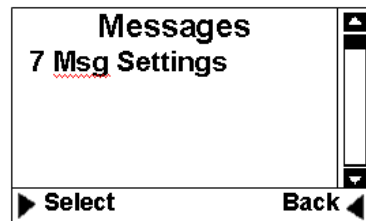

Figure 19 Message: Menu-4

- 1) Voice Mail: You can use this menu item to access to your voice mail box (Note: please contact your service provider for voice mail services).
- 2) New Message: You can use this menu item to create new messages and send out messages. The sent message will be stored to message outbox. You can also send a message to multiple recipients (up to 10 contacts)
- 3) Inbox: You can use this menu item to view all of the received messages. For each message, you can delete, reply or forward it. You can also store the sender's Phone number and make a call to the sender.
- 4) Outbox: Outbox stores all messages you have sent out. You can erase or forward it.
- 5) Erase Messages: You can erase one or all messages from Inbox, Outbox.
- 6) Memory Status: This menu can display the memory status of SMS storage.
- 7) Msg Settings: User can edit the setting of message.
 - Callback: Recipient can view the callback number in the sent message if the function is activated and the Callback number is set.

- Deliver ACK: After recipient receives the message, then CDMA network will send SMS to inform sender the successful delivery of the message.
- Preferred Storage (only when R-UIM is used): this menu item is used to select storage device, Phone memory or R-UIM card.

5.4 Recent Calls

The “Recent Calls” records information of all calls including incoming calls, outgoing calls, and missed calls.

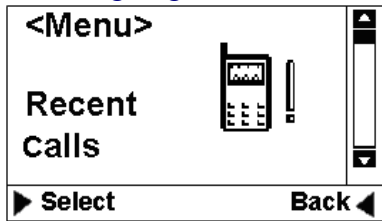

Figure 20 Recent calls: Menu-1

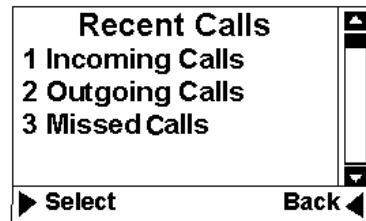

Figure 21 Recent calls: Menu-2

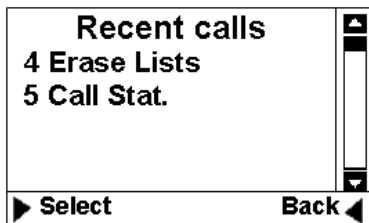

Figure 22 Recent calls: Menu-3

- 1) Incoming Calls: All received calls can be viewed through this menu. For each incoming call entry, you can save the phone number, erase the record, or send SMS to the phone number.

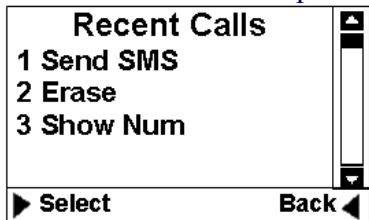

Figure 23 Recent calls: Menu-4

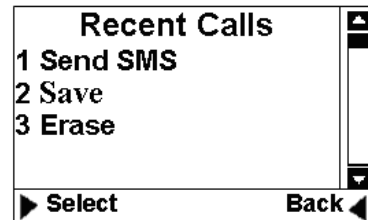

Figure 24 Recent calls: Menu-5

- 2) Outgoing Calls: The information of the calls you have made can be viewed through this menu. For each outgoing call, you can save the phone number, erase the record, or send SMS to the phone number.
- 3) Missed Calls: This menu records all missed Calls. For each missed call, the phone number can be saved.
- 4) Erase All: You can erase incoming calls, outgoing calls, missed calls or erase all by using this menu:

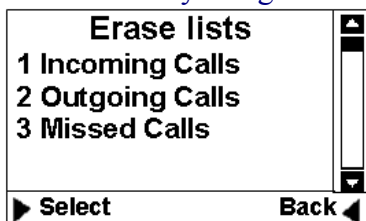

Figure 25 Recent calls: Menu-6

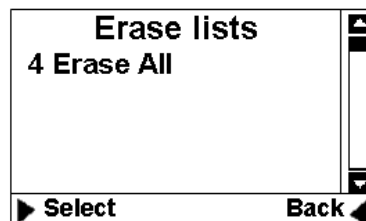

Figure 26 Recent calls: Menu-7

- 5) Call Stat. : This menu stores statistic data for all incoming calls and outgoing calls. The statistic data includes the total number of calls and call duration.

5.5 Tools

The Phone provides you with the following tools:

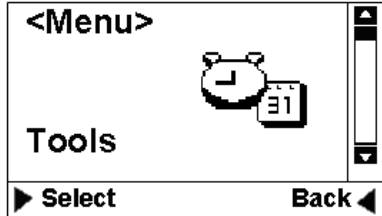

Figure 27 Tools: Menu-1

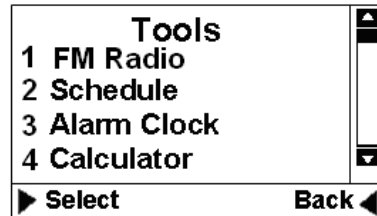

Figure 28 Tools: Menu-2

1) FM Radio :

Insert the headset for FM , and enter FM radio menu

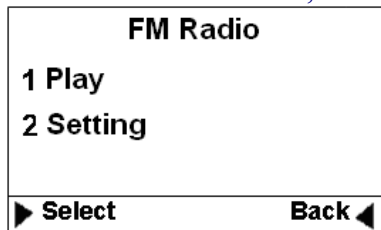

Figure 29 Tools: Menu-3

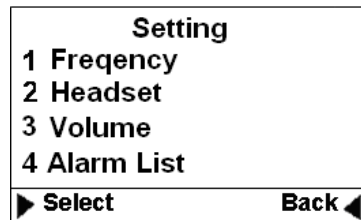

Figure 30 Tools: Menu-4

- Play key/Stop key: user can switch the FM radio function on and off;
- Setting

Frequency :

Channel list : Totally 20 channels can be saved in the list;

Auto Scan : The phone can auto scan FM radio channels. When it has got one, the screen will show “frequency *** Mhz save it Now?”. Press Left Soft Key to save it in the channel list. Or press Right Soft Key to keep searching for the next frequency.

Set Manually :input the digits of the radio frequency in the menu. Press Left Key to save it in the channel list

Loudspeaker/Headset: user can choose the headset or handsfree mode;

Volume: Volume Up and Volume Down

Alarm list: The FM Radio will turn on automatically when it is the set alarm time.

- 2) Schedule: The schedule can be used as an event reminder. Once a schedule has been set up for an event, the Phone will ring to remind you when it is the time. Up to ten schedules can be set at one time. You can view, edit or erase one or all schedules.

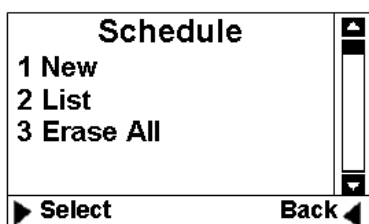

Figure 31 Tools: Menu-3

3) Alarm Clock: The function is the same as regular alarm clock.

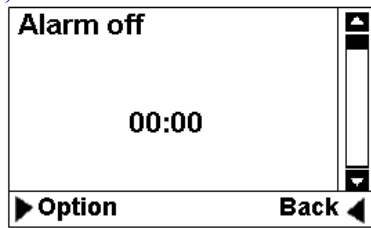

Figure 32 Tools: Menu-4

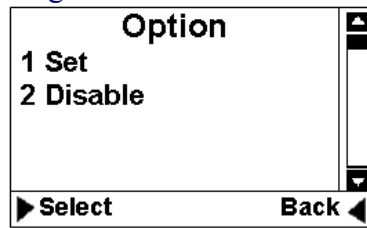

Figure 33 Tools: Menu-5

3) Calculator: "*" Key to enter a decimal point and the "#"Key for a negative sign. Then select plus, minus, multiply, divide by pressing direction keys.

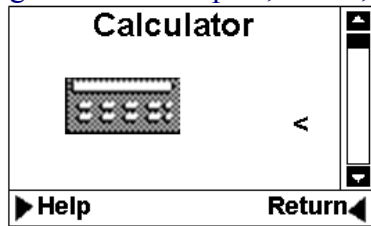

Figure 34 Tools: Menu-6

5.6 Settings

You can use Setting menu to customize the Phone. The Setting menu is shown below:

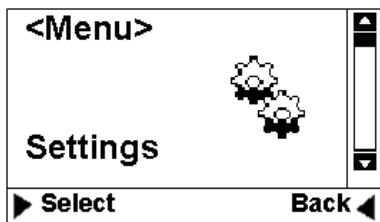

Figure 35 Setting: Menu-1

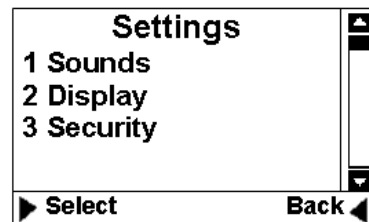

Figure 36 Setting: Menu-2

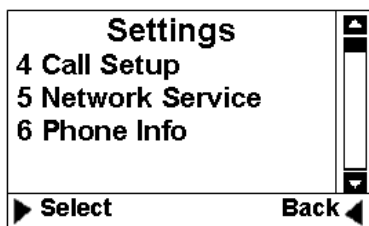

Figure 37 Setting: Menu-3

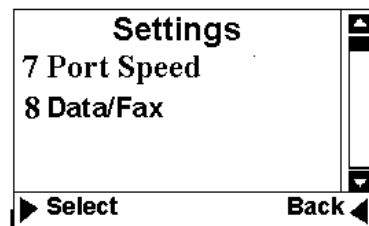

Figure 38 Setting: Menu-4

1. Sounds:
 - Ringer: You can select your preferred ring tone.
 - Volume: You can change the volume of Ringer, Key beep handset, and hands-free.
 - Alert: You can set up alert tones for Service Change, Minute Beep(Reminds every minute during a call), call connect, call disconnect or call waiting..
2. Display
 - Banner: editing the banner for display on idle screen.
 - Backlight: setting up Timer and Brightness of backlight.

- ❑ Contrast: setting LCD contrast.
- ❑ Language: setting up Phone language.

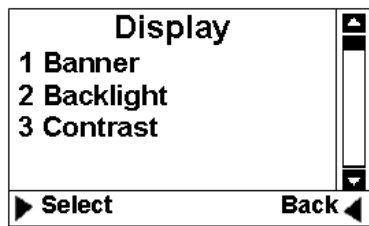

Figure 39 Setting: Menu-5

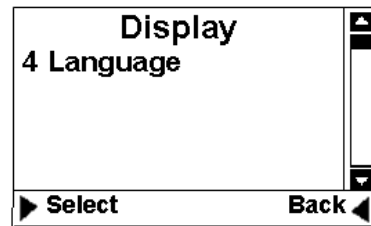

Figure 40 Setting: Menu-6

3. Security

Before entering security menu, you will be requested to input a valid password. The default password is 0000. You can change this password once you enter the security menu successfully. Please remember the new password. You may need to contact the service provider if you happen to forget the new password . .

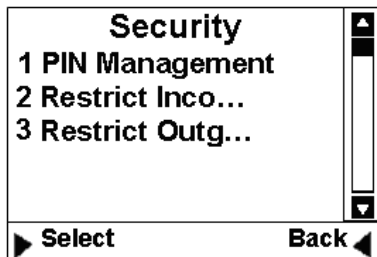

Figure 41 Security-1

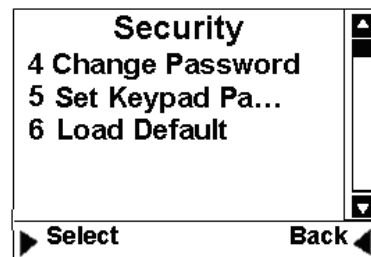

Figure 42 Security-2

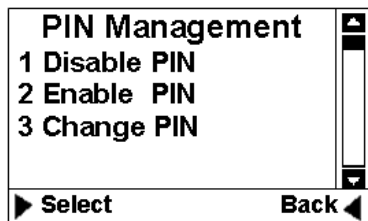

Figure 43 Pin Management

- a) PIN Management: This menu allows you to enable/disable PIN and change PIN. This is ONLY used when R-UIM is used.

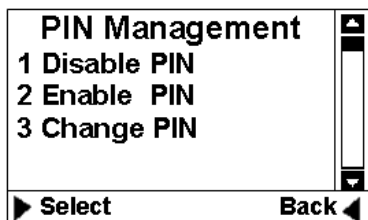

Figure 44 Pin Management

- b) Restrict Incoming Call: You can store up to 10 phone numbers for restricted incoming calls.
- c) Restrict Outgoing Call: You can store up to 10 phone numbers for restricted outgoing calls.

- d) Change Password: You can change the security password through this menu. The user must remember the new password.
 - e) Set Keypad Password: You can change the Keypad locking code. The default number is 0000. Once this is set and Keypad is locked, each time before using the phone, the Keypad password must be entered.
 - f) Load Default: The menu allows you to reset the Phone. This is very important feature. In case your Phone is not working in the way you expected, you can always use “Load Default” to reset your Phone to its default settings.
4. Call Setup: The menu allows you to set up call answer mode, which includes:
- a) Auto Answer: Allows the phone to answer incoming calls automatically.
 - b) Voice Privacy: Turning on “Voice Privacy” to enhance the security of the call by voice encryption.
 - c) Auto Dial Time: When making a phone call, dial the number and wait for a few seconds, the call will be made automatically without pressing Send Key.

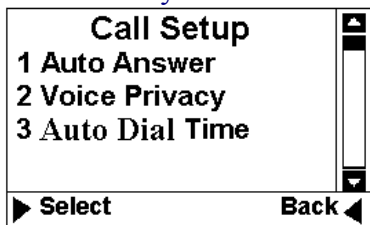

Figure 44 Call setup

5. Network Service :

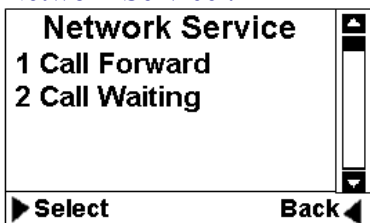

Figure 45 Network Service

- a) Call Forward: You can forward incoming calls to a designated phone number. You can forward incoming call under the following situations:
 - Forward If Busy
 - Forward If No Answer
 - Forward All Calls
 - Forward Crytic
 - b) Call Waiting: You can enable/disable call waiting function through this menu.
6. Phone Info
- a) Phone Number: Your phone number can be input and stored by using this menu.
 - b) SW Version: This menu can display the software version.
 - c) Hardware Version: This menu is used to list the hardware version.

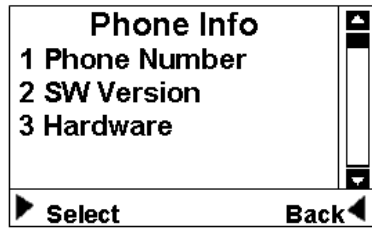

Figure 46 Phone Info

- 7. Port Speed
Customer can choose the port rate from 9600,19200,57600,115200,230400
- 8. Data/Fax:
To set up the default incoming call mode, for fax/Data mode or voice mode.
Suggest NOT to change this option without consulting your service provider.
Improper setting may cause failure to receive incoming calls.

6 Keypad Locking

For better protection, the Phone provides you with Keypad locking feature. You can lock your Phone's Keypad if you do not want someone else to access your Phone while you are away from your Phone.

Once Phone's Keypad is locked, Phone will not allow to make outgoing calls or access other features, such as Contact, Recent Calls. But a locked Phone will allow to accept incoming calls and notify you for any incoming short messages. Unlock the Keypad before using the Phone.

6.1 Lock Keypad

- When the Phone is at idle state (Phone must be at idle state), firmly press “#” Key for over 2 seconds, the Keypad will be locked, and a pop-up window will be displayed as following:



Figure 47 Lock Keypad-1

- When any Key is pressed while Keypad is locked, Phone will show a password dialog box. The default password for unlocking Keypad is: 0000. (Note: In case you forget the Keypad locking code, you will have to ask your service provide to unlock the phone).

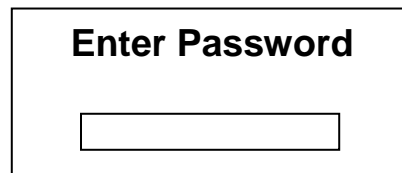

Figure 48 Lock Keypad-2

- Once Keypad is locked, at idle state, “Key Guard Mode” message will be displayed on LCD to indicate that the Keypad is locked:

-

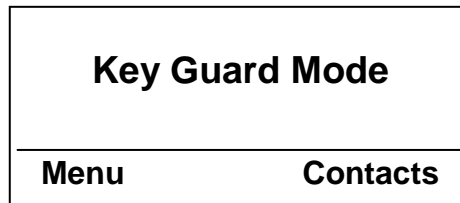

Figure 49 Lock Keypad-3

6.2 Modify Keypad Locking Code

- Go to Settings menu, then choose “Security” sub-menu, from there, you will find “Set Keypad Password” sub-menu, once this menu is selected, LCD will show a password dialog box. Enter a new password for keypad locking:

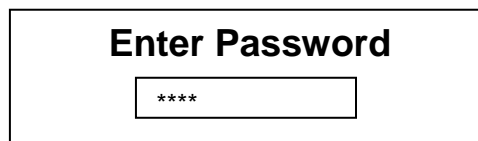

Figure 50 Set Keypad Password-1

- After a new password is entered, a password confirmation dialog box will be displayed. Re-enter the new password you just input:



Figure 51 Set Keypad Password-2

- If above two passwords are entered properly, you will have a new password.

7 Data Service

L100 Phone can provide circuit data service (14.4 kbps) and high speed data service (up to 153.6kbps, the actual speed depends on your CDMA service provider and the service you have purchased). You can use the Phone as a modem for your computer.

**** Refer user Manual in the CD disk for Data Services**

8 Technical Specifications

Frequency:	CDMA 800MHZ
Maximum Transmitting Power:	> 23 dBm @ 50 ohm
Receiving Sensibility:	< -105dBm/1.23MHz;
External DC Voltage:	DC 6.6 V
Operation Temperature:	-10°C ~ +45°C
Ambient Humidity:	0~95%
Storage Temperature:	-30°C~+60°C
Pressure:	86—106Kpa

9 Quick Troubleshooting Guide

- ❑ Unable to send/receive data/fax calls: Check the connections to computer and verify that necessary software has been properly installed and configured.
- ❑ Moisture or ventilation problems: Visually inspect the Phone body, moisture can damage the Phone. Ventilation is also very important. Move the Phone to improve the ventilation as necessary.
- ❑ No power: Verify that AC power source and its corresponding circuit breaker are functioning properly.
- ❑ If Phone can't make data connection:
 1. Make sure to follow Modem installation procedures
 2. Make sure that you have purchased CDMA1x service from your CDMA service provider
 3. Make sure that modem driver and proper software are installed correctly in PC.
- ❑ Unable to receive incoming calls:
 1. Make sure that the incoming call is not restricted;
 2. Make sure the FAX/DATA mode setting is OFF
 3. Make sure that your Phone is having good signal reception
- ❑ Unable to make outgoing calls:
 1. Make sure that the numbers you dialed are not restricted;
 2. Make sure that your Phone is having good signal reception
- ❑ Unable to receive SMS: Make sure that your Phone's memory is not full for storing SMS. If the memory is full, please empty inbox.
- ❑ REMEMBER: you can always use "Load Default" sub-menu in "Security" menu to reset your Phone to its default settings.
- ❑ While charging the battery, DON'T disconnect the charger before the battery is fully charged.

SAR INFORMATION

The SAR limit of USA (FCC) is 1.6 W/kg averaged over one gram of tissue. Device types (FCC ID: XYOGC159132) has also been tested against this SAR limit. The highest SAR value reported under this standard during product certification for use at the ear is 1.06 W/kg and when properly worn on the body is 1.33 W/kg. This device was tested for typical body-worn operations with the back of the handset kept 1.5cm from the body. To maintain compliance with FCC RF exposure requirements, use accessories that maintain a 1.5cm separation distance between the user's body and the back of the handset. The use of belt clips, holsters and similar accessories should not contain metallic components in its assembly. The use of accessories that do not satisfy these requirements may not comply with FCC RF exposure requirements, and should be avoided.

NOTE: This equipment has been tested and found to comply with the limits for a Class B digital device, pursuant to Part 15 of the FCC Rules. These limits are designed to provide reasonable protection against harmful interference in a residential installation. This equipment generates, uses and can radiate radio frequency energy and, if not installed and used in accordance with the instructions, may cause harmful interference to radio communications. However, there is no guarantee that interference will not occur in a particular installation. If this equipment does cause harmful interference to radio or television reception, which can be determined by turning the equipment off and on, the user is encouraged to try to correct the interference by one or more of the following measures:

- Reorient or relocate the receiving antenna.
- Increase the separation between the equipment and receiver.
- Connect the equipment into an outlet on a circuit different from that to which the receiver is connected.
- Consult the dealer or an experienced radio/TV technician for help.

This device complies with Part 15 of the FCC Rules

Operation is subject to the following two conditions:

- (1) this device may not cause harmful interference, and
- (2) this device must accept any interference received, including interference that may cause undesired operation.

NOTICE:

Changes or modifications made to this equipment not expressly approved by (asiatelco) may void the FCC authorization to operate this equipment.