

BT-M850W Cable Modem

User's Manual

Rev:01

2002/09/19

Information in this document is subject to change without notice. No part of this document may be reproduced or transmitted in any form or by any means, electronic or mechanical, for any purpose, without the express written permission of the seller.

The seller provides this documentation without warranty, term, or condition of any kind. The seller may make improvements or changes in the product(s) and/or the program(s) described in this documentation at any time.

Other product and company names herein may be trademarks of their respective owners.

2002/09/19

Rev:01

Safety Notes

For Installation

- Use only the type of power source indicated on the marking labels.
- Use only the power adapter supplied with the product.
- Do not overload wall outlet or extension cords as this may increase the risk of electric shock or fire. If the power cord is frayed, replace it with a new one.
- Proper ventilation is necessary to prevent the product overheating. Do not block or cover the slots and openings on the device, which are intended for ventilation and proper operation. It is recommended to mount the product with a stack.
- Do not place the product near any source of heat or expose it to direct sunshine.
- Do not expose the product to moisture. Never spill any liquid on the product.
- Do not attempt to connect with any computer accessory or electronic product without instructions from qualified service personnel. This may result in risk of electronic shock or fire.
- Do not place this product on an unstable stand or table.

For Using

- Power off and unplug this product from the wall outlet when it is not in use or before cleaning. Pay attention to the temperature of the power adapter. The temperature might be high.
- After powering off the product, power on the product at least 15 seconds later.
- Do not block the ventilating openings of this product.
- When the product is expected to be not in use for a period of time, unplug the power cord of the product to prevent it from the damage of storm or sudden increases in rating.

For Service

Do not attempt to disassemble or open covers of this unit by yourself. Nor should you attempt to service the product yourself, which may void the user's authority to operate it. Contact qualified service personnel under the following conditions:

- If the power cord or plug is damaged or frayed.
- If liquid has been spilled into the product.
- If the product has been exposed to rain or water.
- If the product does not operate normally when the operating instructions are followed.
- If the product has been dropped or the cabinet has been damaged.
- If the product exhibits a distinct change in performance.

Warning

- **"WARNING - FCC RF exposure requirements: The antenna(s) used for this transmitter must be installed to provide a separation distance of at least 20 cm from all persons and must not be co-located or operating in conjunction with any other antenna or transmitter. "**
- This device complies with Part 15 of the FCC Rules. Operation is subject to the following two conditions: (1) this device may not cause harmful interference, and (2) this device must accept any interference received, including interference that may cause undesired operation.

Caution

- Any changes or modifications not expressly approved by the party responsible for compliance could void the authority to operate equipment.

Contents

Before You Use	vi
Features	vi
System Requirements	vi
Unpacking.....	vii
Chapter 1: Overview	1
Physical Outlook	1
<i>Front Panel</i>	1
<i>Rear Panel</i>	2
Chapter 2: Installation	3
Connecting the Cable Modem to Your Computer	3
<i>Installation Procedure for Ethernet Interface</i>	3
<i>Installation Procedure for USB Interface</i>	3
Chapter 3: Software Installation and Configuration	5
USB Driver Installation.....	5
<i>For Windows 98/ME</i>	5
<i>For Windows 2000/XP</i>	7
Uninstall USB Driver	9
<i>For Windows 98/ME</i>	9
<i>For Windows 2000/XP</i>	9
Setting TCP/IP on Client PC	11
<i>For Windows 98/ME</i>	11
<i>For Windows 2000/XP</i>	15
DHCP Server	18
<i>For Windows 98/ME</i>	18
<i>For Windows NT/2000/XP</i>	19
<i>For Apple Macintosh</i>	20
Renew PC IP Address	21
Chapter 4: Web Configuration	23
Usin4g Web-Based Manager	23
Status	23
<i>Software</i>	23
<i>Connection</i>	24
<i>Security</i>	24
Wireless.....	25
<i>Basic</i>	25
<i>Privacy</i>	25
<i>Advanced</i>	26
Chapter 5: Access Internet through Cable Modem	29
Accessing Internet.....	29

Chapter 6: Troubleshooting 31

Appendix: Specifications..... 33

Before You Use

The BT-M850W is a DOCSIS 1.0/1.1 and CableHome 1.0 compliant wireless cable residential gateway that provide high-speed connectivity to residential, commercial, and education subscribers on public and private networks via an existing cable infrastructure. The BT-M850W is equipped with 4-port Ethernet switch, USB, IEEE802.11b Wireless, HPNA interfaces. The BT-M850W can inter-operate with any DOCSIS and CableHome compliant headend equipment. The IP traffic can transfer between the BT-M850W and DOCSIS and CableHome compliant headend equipments. The data security secures upstream and downstream communications.

Features

- Up to 42.88 Mbps downstream and up to 10.24 Mbps upstream, two-way cable modem.
- F-Connector for the cable interface.
- Build-in IEEE 802.11b Wireless Access Point function
- Bridging wired & wireless segments of network
- Provide 11 / 5.5 / 2 / 1 Mbps wireless connectivity to the wireless clients
- Support Wired Equivalent Privacy Algorithm (WEP)
- Roaming by Association/Re-association/De-association
- Four ports 10/100BaseT Ethernet switch with auto-negotiation function and auto-media dependent interface crossover (MDIX).
- USB Connector for USB interface
- Home PNA 2.0 support
- NAT (Network Address Translation) to support multiple users with one IP account for routing mode.
- Transparent bridging for IP traffic for bridge mode
- Firewall function
- RSA and 56 bit DES data encryption security
- Interoperable with any DOCSIS and CableHome compatible headend equipment
- SNMP v1/v2c/v3 network management support
- Remote operating firmware downloading
- Support Web pages and private DHCP server for status monitoring
- Clear LED display
- Universal Plug and Play

System Requirements

This cable modem equips ETHERNET and USB interfaces. You can choose either one to connect to the cable modem. Before installing the EMTA, please check the following requirements with your computer.

For Ethernet Connection

- ◆ Windows98/2000/NT/ME/XP operating system or Apple Macintosh series
- ◆ 10/100 Base-T NIC(network interface card)
- ◆ Subscribe to a Cable Television Company for cable modem service

For USB Connection

- ◆ Windows98/2000/ ME/XP operating system
- ◆ Available USB port
- ◆ Subscribe to a Cable Television Company for cable modem service

For Phone Connection

- ◆ Standard touch-tone telephone and phone cord with RJ-11 connector
- ◆ Subscribe to a VoIP system company (VoIP service provider) for VoIP services

Unpacking

Check the contents of the package against the pack contents checklist below. If any of the items is missing, then contact the dealer from whom the equipment was purchased.

- Cable Modem
- Twisted Pair Ethernet Cable (CAT5/RJ-45)
- USB Cable
- Power Adapter & Power Cord
- Quick Start Guide
- Software CD

Chapter 1: Overview

Physical Outlook

Front Panel

The following illustration shows the front panel of the EMTA machine:

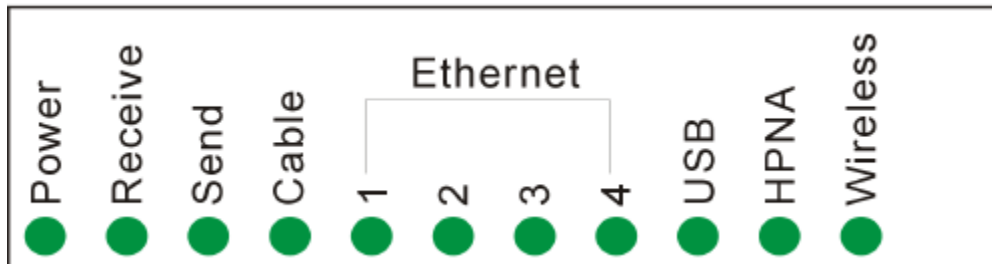

LED Indicators

The LEDs on the front panel are described in the table below (from left to right):

LED	Color	Status	Description
Power	Green	Off	Power off.
		On	Power on.
Receive	Green	Blinking	Indicates receiving RF DS data
Send	Green	Blinking	To indicate transmit RF US traffic.
Cable	Green	On	Modem registration completed.
		Blinking	To indicate RF link status at different speed. 1. Scanning DS 2. US ranging 3. DHCP/TFTP/Registration
Ethernet 1 ~ 4	Green	On	Ethernet carrier is present.
		Blinking	To indicate Ethernet data.
USB	Green	On	To indicate USB link is present.
		Blinking	To indicate USB transmitting or receiving data
HPNA	Green	On	To indicate HPNA link is present.
		Blinking	To indicate HPNA transmitting or receiving data
Wireless	Green	On	To indicate wireless link is present.
		Blinking	To indicate Wireless AP transmitting or receiving data

Rear Panel

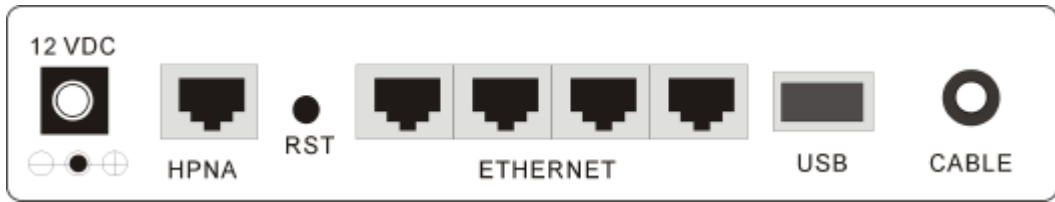

- 12VDC:** 12V Power connector
- HPNA:** RJ-11 Home PNA Connector
- RST :** Reset-to-Default push button
- ETHERNET :** Ethernet 10/100BaseT RJ-45 connector
- USB :** USB Connector
- CABLE :** F-Connector

Chapter 2: Installation

This cable modem equips USB and Ethernet interfaces. You can choose either one to connect to the cable modem. Go to the section “Installation Procedure for Ethernet Interface”, if your computer has installed TCP/IP and Ethernet card with 10/100BaseT capability. Go to the section “Installation Procedure for Ethernet USB Interface”, if your PC has USB port and the operating system is Microsoft Windows 98/ME/XP or Windows 2000.

Connecting the Cable Modem to Your Computer

Installation Procedure for Ethernet Interface

Follow the steps below for proper installation:

1. Make sure your computer meets the system requirements.
2. Connect a coaxial cable (supplied by the local Cable Television Company) to the CABLE connector on the modem.

Note: To speed up the registration process of cable modem, the coaxial cable should be connected to the modem prior to the power connector.

3. Connect the RJ-45 Ethernet cable to one of the ETHERNET connector on the modem, connect the other end with the 10/100BaseT Ethernet port on your computer.
4. Plug the power adapter into the POWER connector of the modem.
5. Plug the other end of the power adapter into a power outlet.
6. The cable modem will look for the proper cable modem signal in the Cable Television network and process the initial registration. The cable modem is ready for data transfer after the LED “Power” is in solid green.

Note: The RST button at the rear panel is for maintenance purpose only.

Installation Procedure for USB Interface

Follow the steps below for proper installation:

1. Make sure your computer meets the system requirements.
2. Connect a coaxial cable (supplied by the local Cable Television Company) to the CABLE connector on the modem.

Note: To speed up the registration process of cable modem, the coaxial cable should be connected to the modem prior to the power connector.

3. Connect the USB cable to the USB connector on the modem.
4. Plug the power adapter into the POWER connector of the modem.
5. Plug the other end of the power adapter into a power outlet.
6. The cable modem will look for the proper cable modem signal in the Cable Television network and process the initial registration. The cable modem is ready for data transfer after the LED “Power” is in solid green.

Note: The RST button at the rear panel is for maintenance purpose only.

Below shows the connection status among the cable modem and your computer.

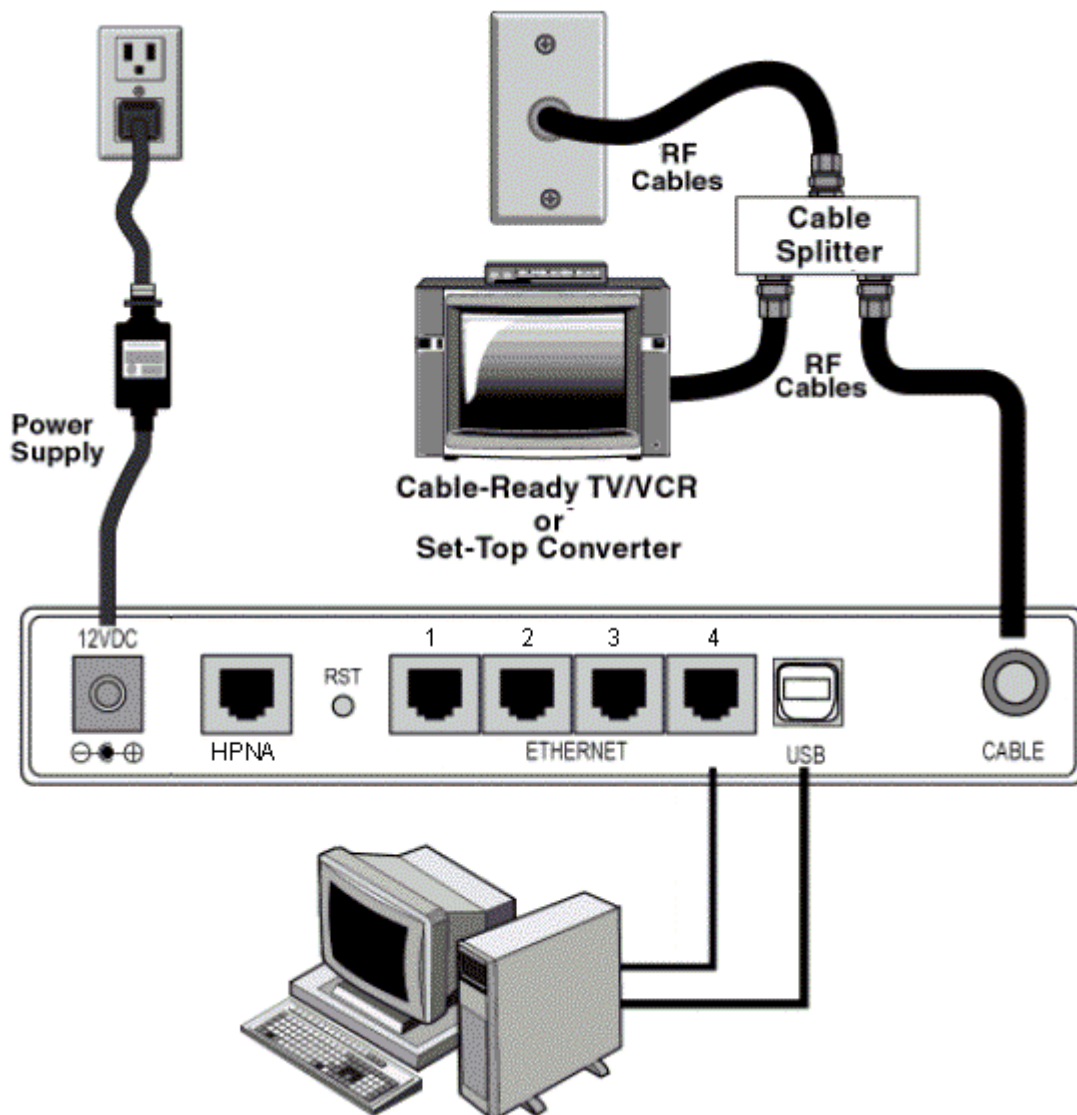

Chapter 3: Software Installation and Configuration

USB Driver Installation

For Windows 98/ME

1. Wait for the cable modem is running in the operational state (registration O.K.). Plug the USB cable into your PC USB port. You will see the next page. Click the “Next” button.



2. Select “Search for the best drivers for your device“ and click the “Next” button.



3. Check “Specify a location” and browse CD-ROM:\Win9x or WinME. Click the “Next” button.



- 4. Select "The updated driver..." and click the "Next" button.

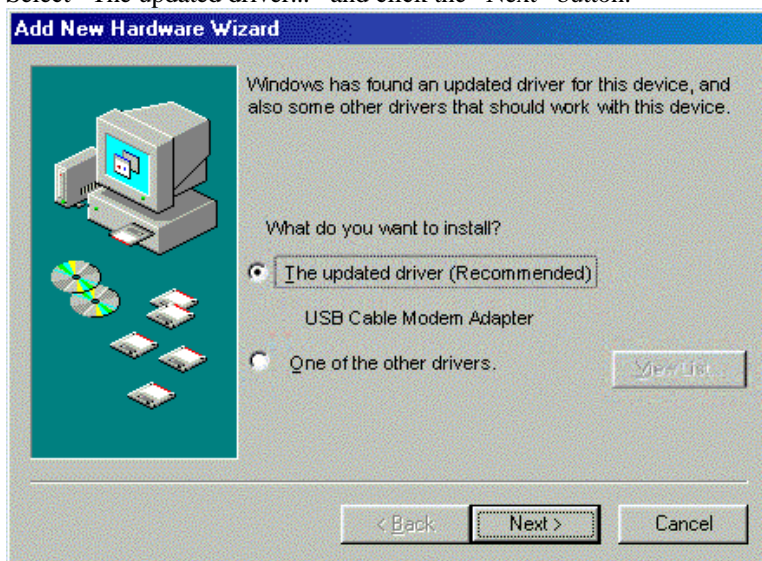

- 5. Click the "Next" button.



- 6. Installation has been completed here. Click the "Finish" button.



7. The system will ask you to restart your computer. Click “Yes” to complete the installation.

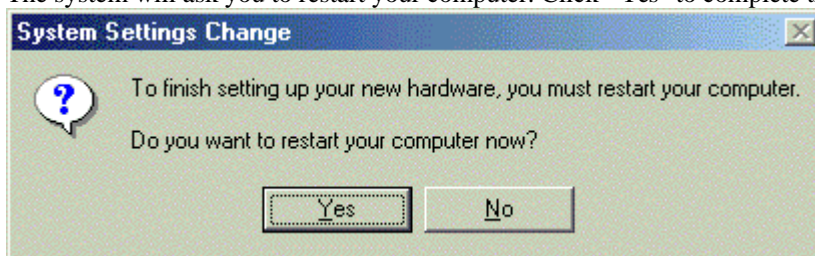

For Windows 2000/XP

1. Wait for the cable modem is running in the operational state (registration O.K.). Plug the USB cable into your PC USB port.



2. You will see the next page. Click the “Next” button.

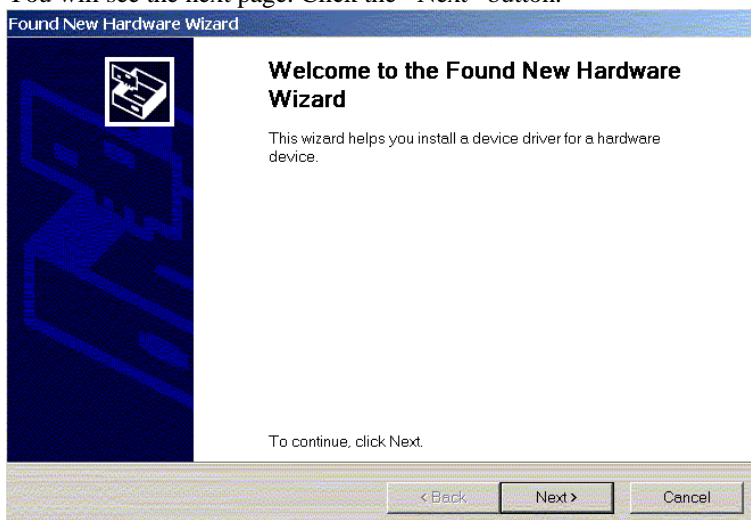

3. Select “Search for a suitable driver for my device“ and click the “Next” button.



- 4. Insert the driver CD into CD-ROM. Select “CD-ROM drive” and clicks the “Next” button.

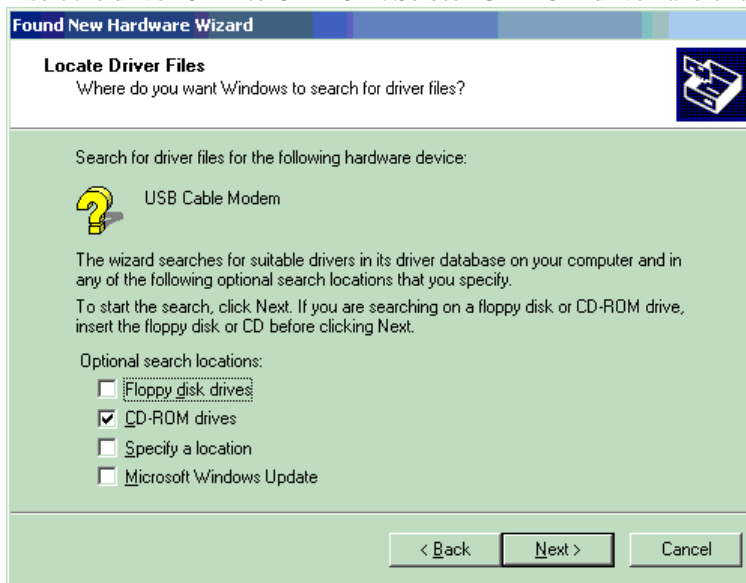

- 5. Click the “Next” button.

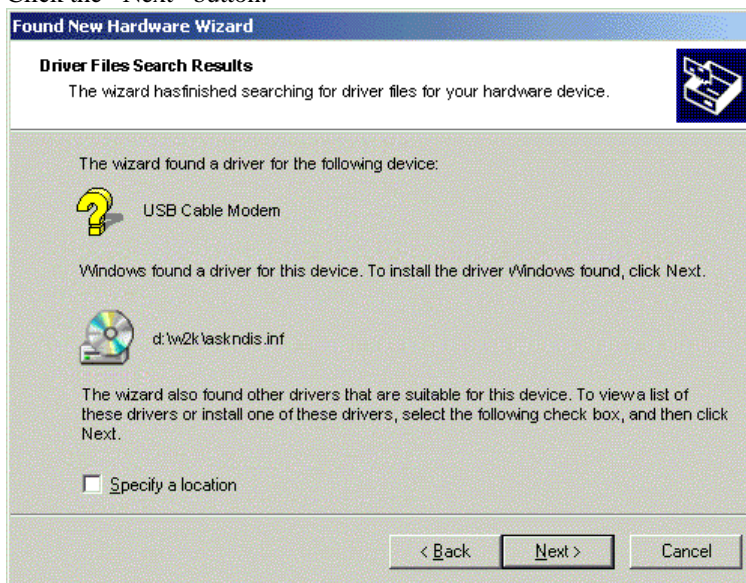

- 6. A Digital Signature Not Found dialog box appears to ask you to continue the installation or stop the procedure. Please click **Yes**. Then Windows will copy the drivers from the Software Utility CD.

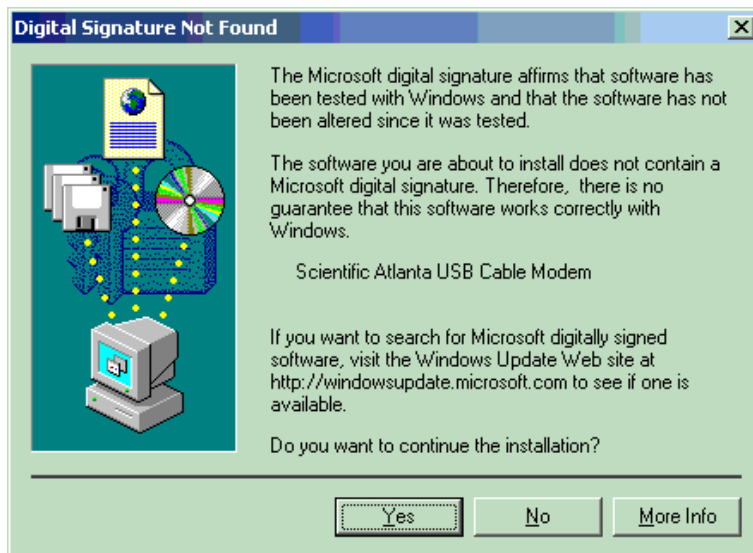

7. Installation has been completed here. Click the “Finish” button.

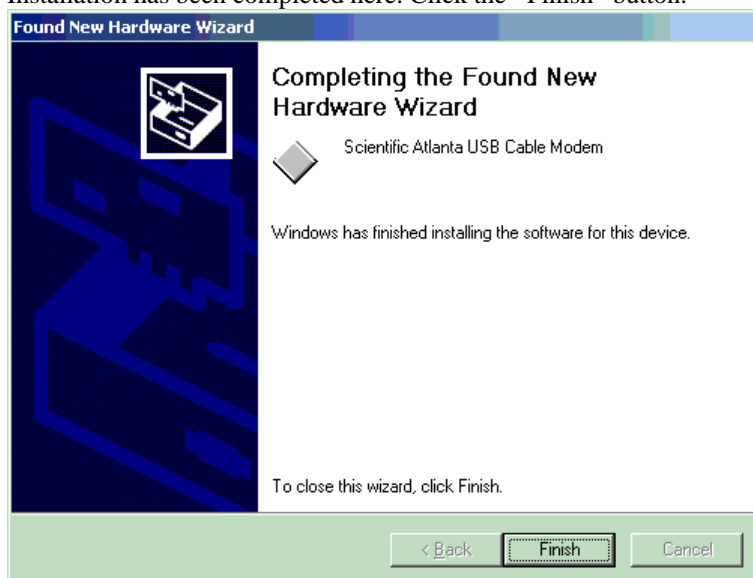

Uninstall USB Driver

For Windows 98/ME

1. Click “Start” button on your computer’s taskbar, point to “Settings”, and then click “Control Panel”.
2. Select **Add/Remove Programs**.
3. On the **Install/Uninstall** tab, select **USB Cable Modem Adapter** from the list box. Click the **Add/Remove** button.
4. A confirmation dialog appears. Click **Yes**.
5. A dialog box appears to ask you unplug USB cable, please unplug the cable and click **OK**.

For Windows 2000/XP

1. Click on the **Start** menu, point to **Settings** and click on **Control Panel**.
2. Select **Add/Remove Programs**.
3. Select **USB Cable Modem Adapter** from the list box.
4. Click the **Change/Remove** button.
5. Click **Yes** button.

- 6 A dialog box appears to ask you unplug USB cable, please unplug the cable and click **OK**.

Setting TCP/IP on Client PC

After you successfully complete the network interface card (Ethernet card) installation task, you need to make sure the TCP/IP communications protocol used by the Ethernet card is installed and correctly configured on your system.

For Windows 98/ME

1. Click on the **Start** menu, point to **Settings** and click on **Control Panel**.

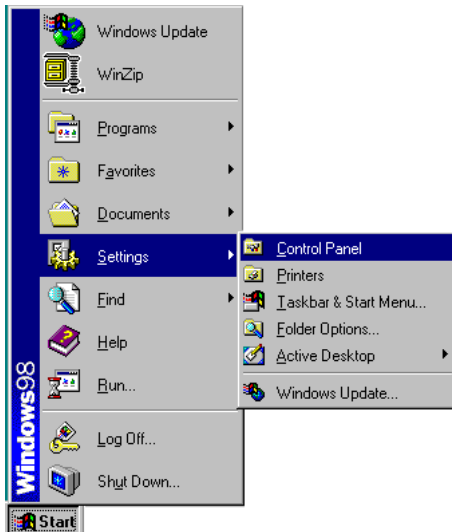

2. The Control Panel window will show up. Double-click the “Network” icon in the Control Panel window.



3. Windows will appear the Network dialog box. Click “Configuration” tab to bring it to the front, and on this tab, a list of installed network components appears.

Option 1: If you have **no** TCP/IP protocol, click **Add**.

Option 2: If you have TCP/IP protocol, go to Step 7.

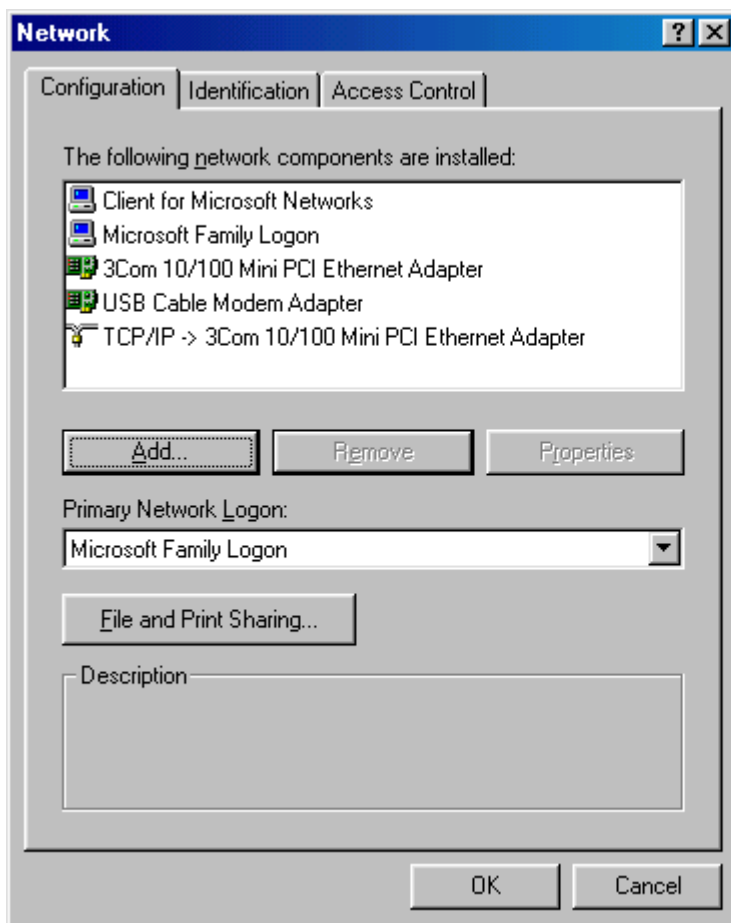

4. The Select Network Component Type dialog box will show up. Click "Protocol", and then click "Add".

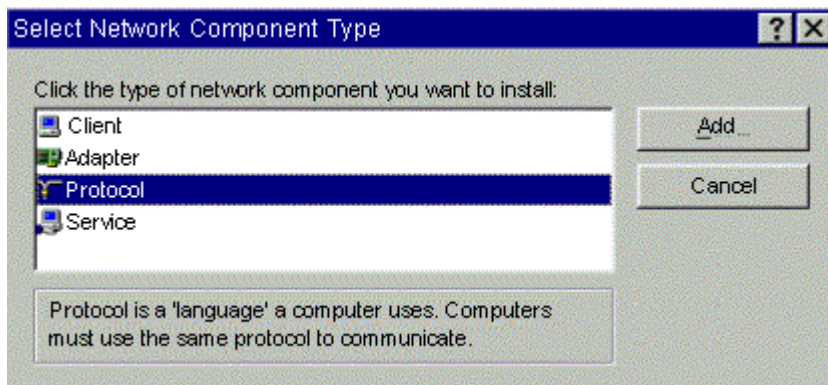

5. You will see the Select Network Protocol dialog box. Click "Microsoft" in the "Manufactures:" list, and then click "TCP/IP" in the "Network Protocols:" list. Click "OK".

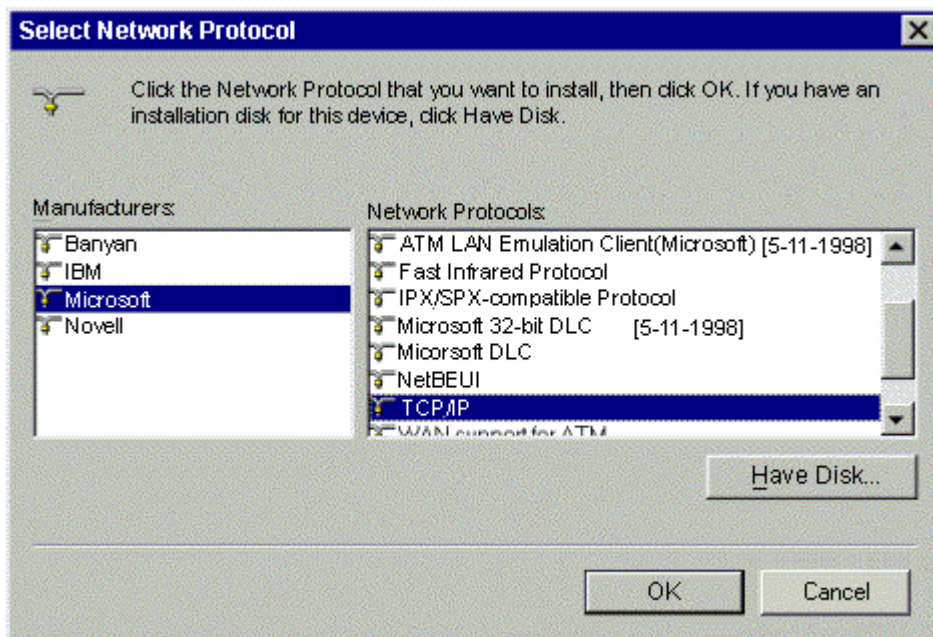

6. You will be directed back to the Network dialog box, and on the "Configuration" tab, the entry that includes TCP/IP -> followed by the Ethernet card installed in your computer will appear in the list of installed network components.
7. Click TCP/IP -> followed by the Ethernet card installed in your computer, and then click "Properties". The TCP/IP Properties dialog box will appear.

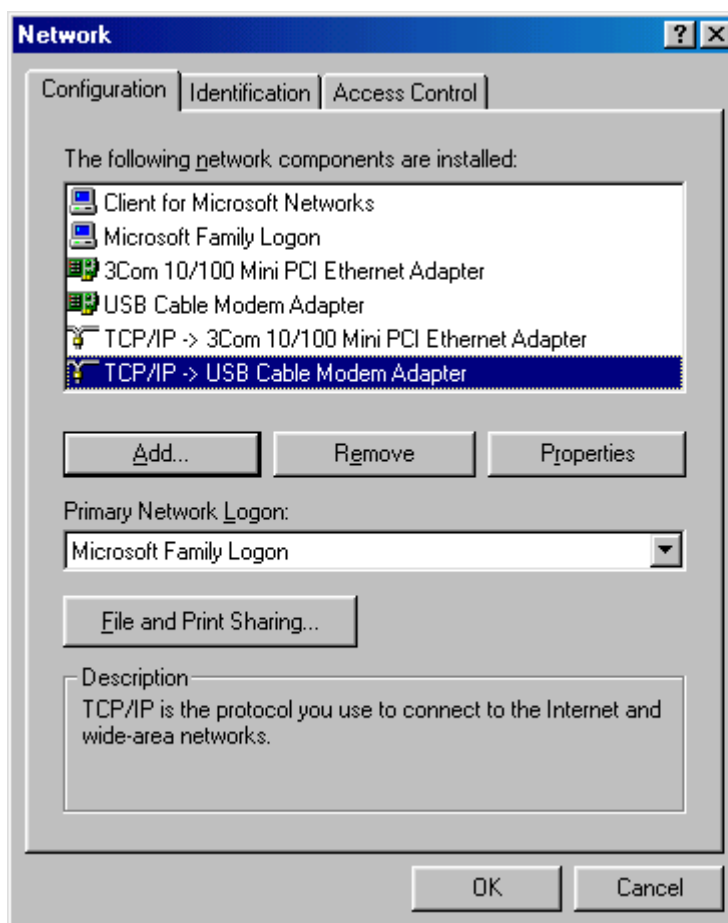

8. In the TCP/IP Properties dialog box, please follow the directions below: Click "IP Address" tab to bring it to the front, and then click "Obtain an IP address automatically" on the tab.

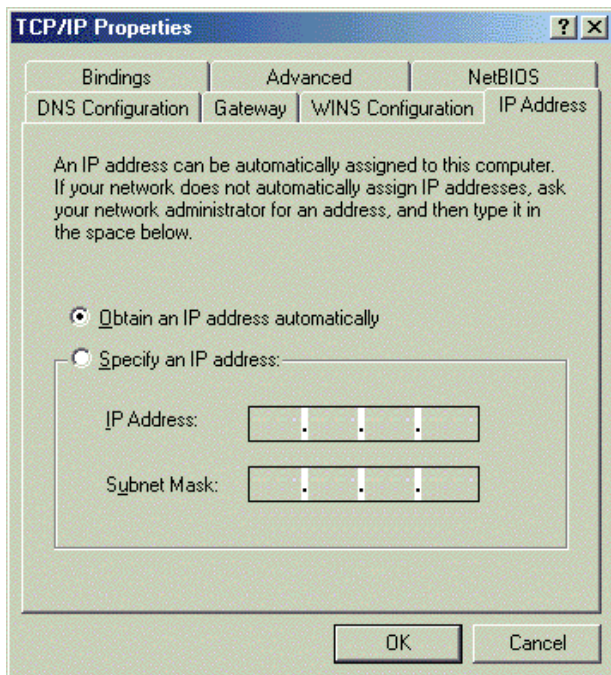

9. Click "Gateway" to bring it to the front. On this tab, leave the "New gateway:" blank. If there is the entry in the "Installed gateway:" list, click it and then click "Remove" to remove all installed gateways.

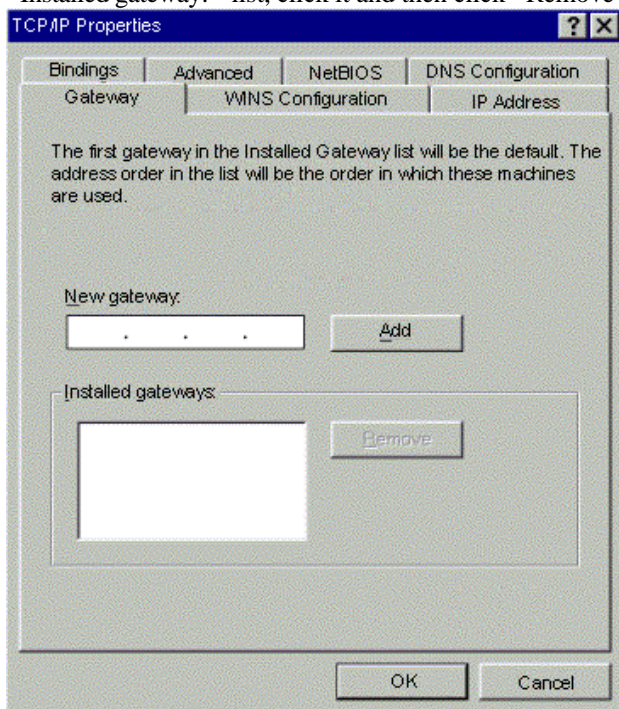

10. Click "DNS Configuration" tabs to bring it to the front, and click "Disable DNS", then click "OK" to close the dialog box.

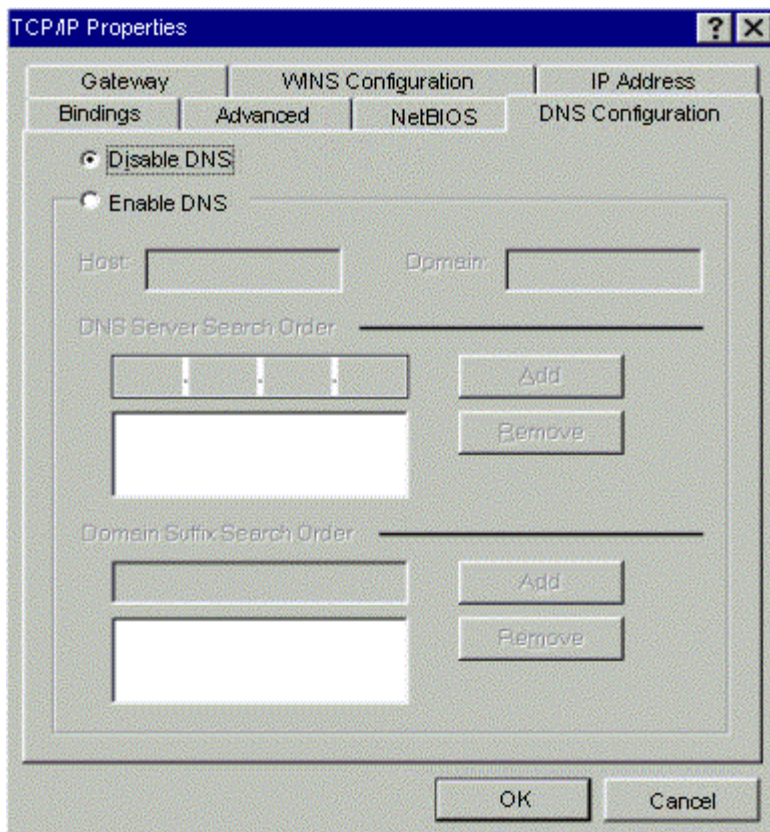

- The Copying Files dialog box will pop up and the system will start copying files from Windows. At the first time you will be asked to insert the Windows 98 CD-ROM into the CD-ROM drive during the files copying, and follow the instructions when they show up, then click “OK”. It will prompt another Copying Files dialog box. Please type the command line that Windows files located in the dialog box (For example, D:\win98). Click “OK” to continue the files copying.

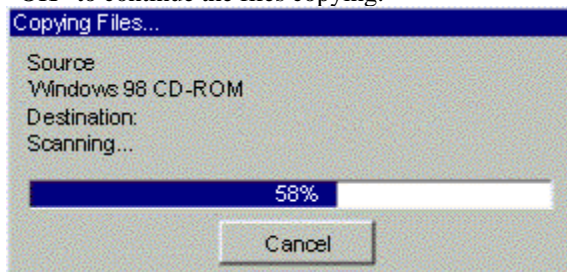

- Windows will appear the System Settings Change dialog box and ask you if you would like to restart your computer. Click “Yes”.

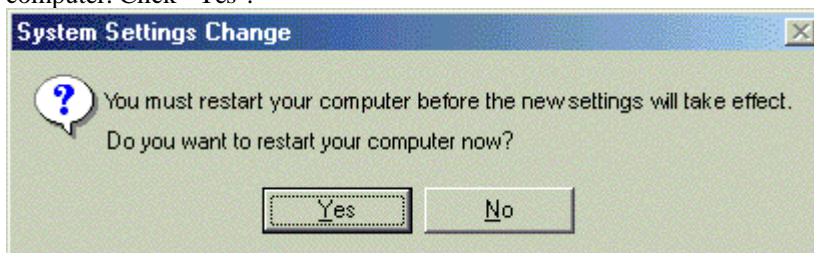

For Windows 2000/XP

- Click “Start” button on your computer’s taskbar, point to “Settings”, and then click ”Network and Dial-up Connections”.

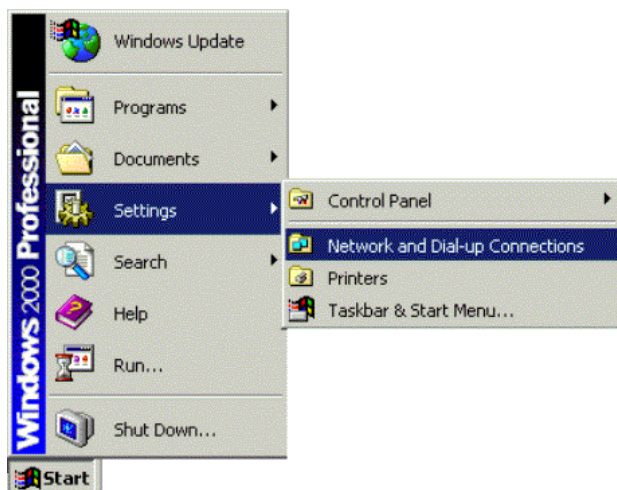

2. The Network and Dial-up Connections window will show up. Double-click “Local Area Connection” icon in the Network and Dial-up Connections window.

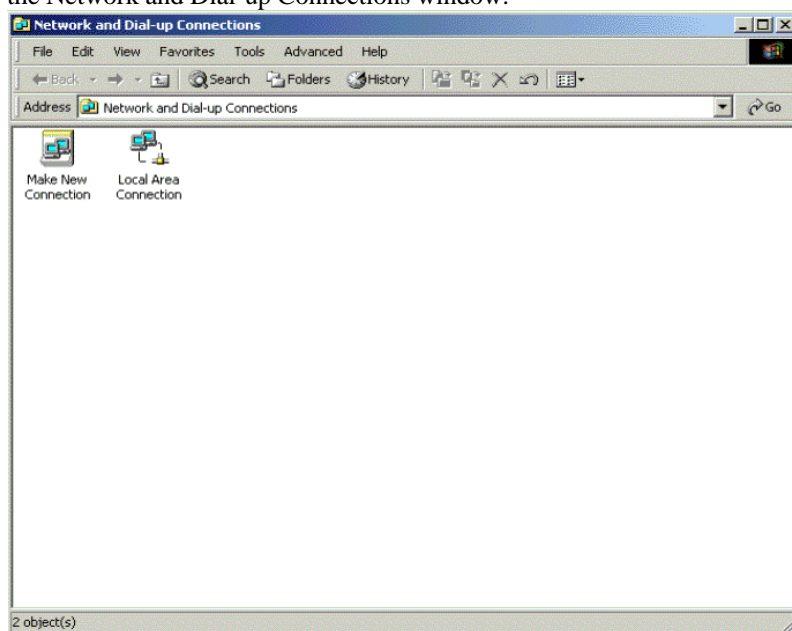

3. The Local Area Connection status window will show up. Click the “Properties” button.

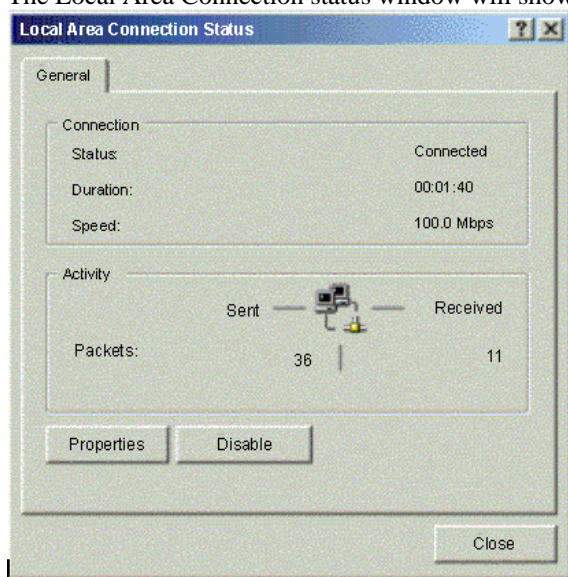

4. Click “Internet Protocol (TCP/IP)” and then click “Properties”.

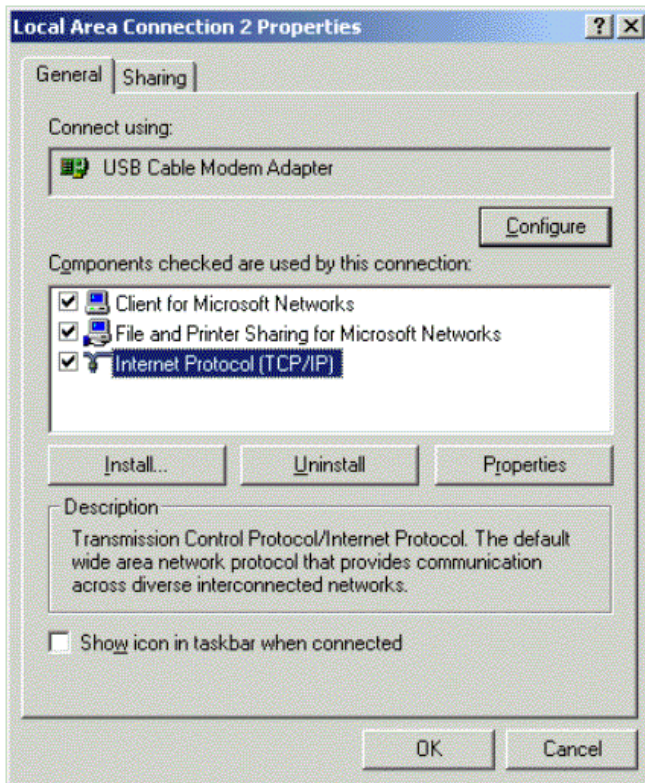

- The Internet Protocol (TCP/IP) Properties dialog box appears. Click “Obtain an IP address automatically”. Click “Obtain DNS server address automatically”. Click “OK” to close the dialog box.

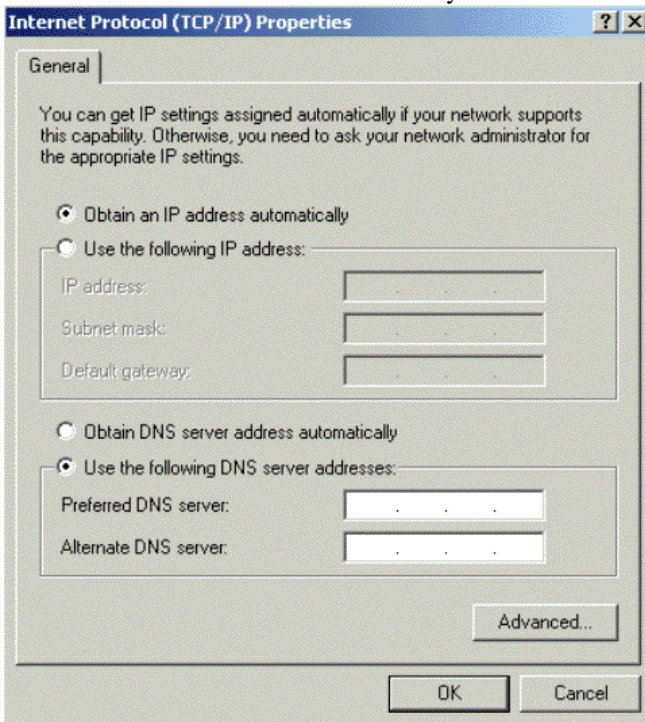

- Windows will appear the System Settings Change dialog box and ask you if you would like to restart your computer. Click “Yes”.

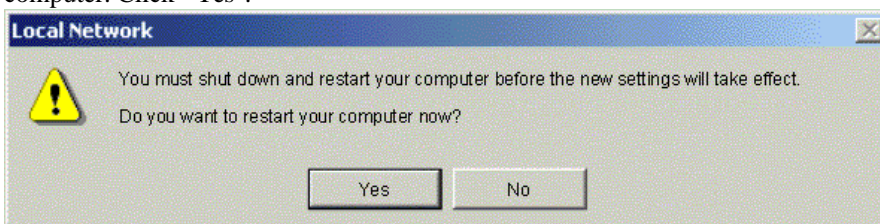

DHCP Server

PC connected to the cable modem can automatically get a private IP address from the DHCP server of cable modem before cable modem is on line. The following steps will show you how to get an IP address.

For Windows 98/ME

1. Click "Start", point to "Run", and click to open the "Run" windows.

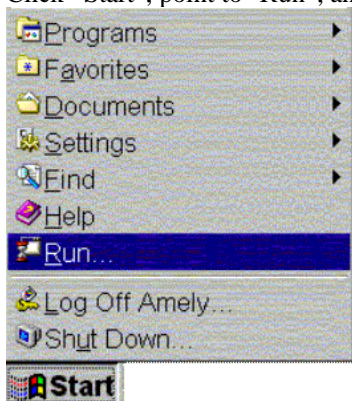

2. Enter "winipcfg" in the "Open" field. Click "OK" to execute the winipcfg and show the "IP Configuration" window.

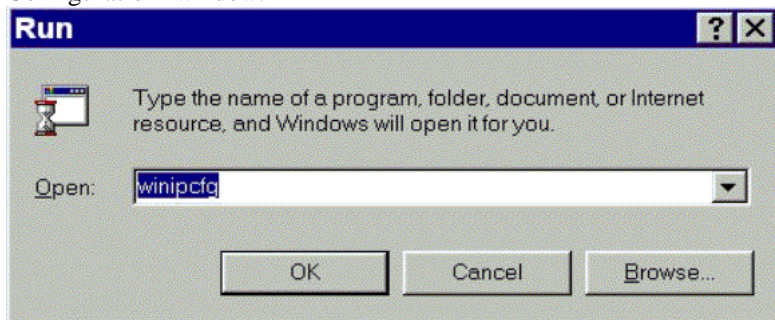

3. Select the "Ethernet adapter" to show the IP address. Press "Release" and "Renew" if the PC is not accessing the Internet. After the cable modem is on line, you need to press the "Release" and "Renew" to get a new IP address from your ISP's server.

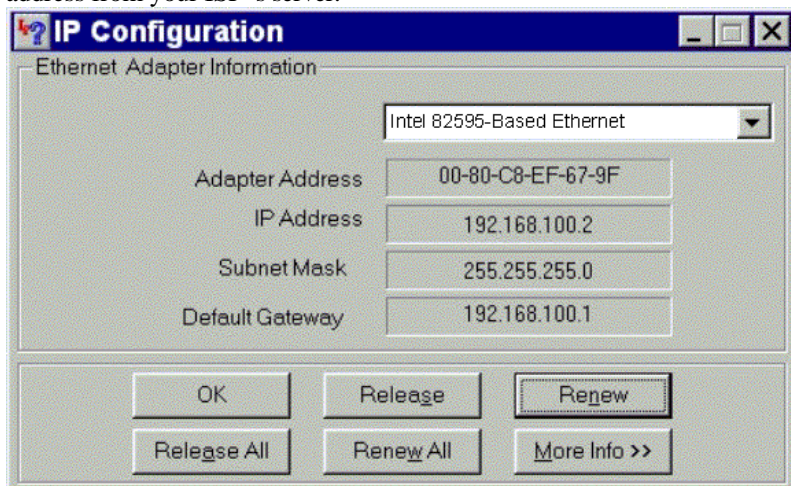

For Windows NT/2000/XP

1. Click “Start“, point to “Run“, and click to open the “Run“ windows.

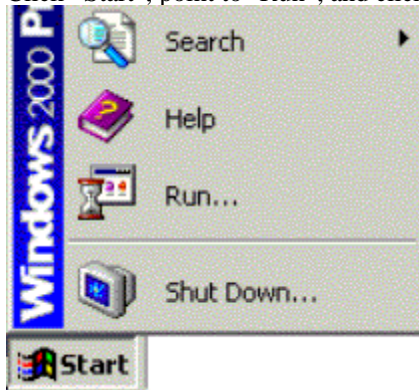

2. The Run dialog box appears. Type “cmd” in the “Open” field, and then click “OK” to execute the command.

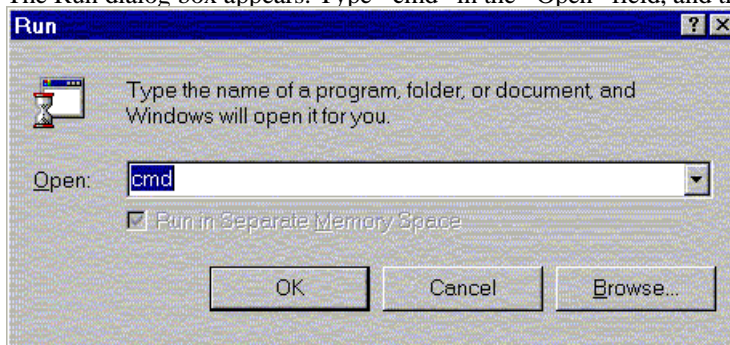

3. You will enter the dos mode, type “ipconfig”, press “Enter” on your keyboard, and you will see the IP address your computer get from the cable modem.

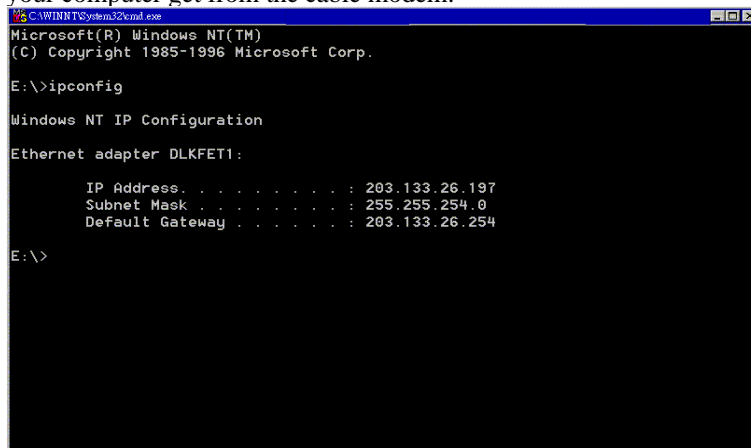

4. If PC is not access Internet, type “ipconfig /release”, and press “Enter” on your keyboard to release the IP.

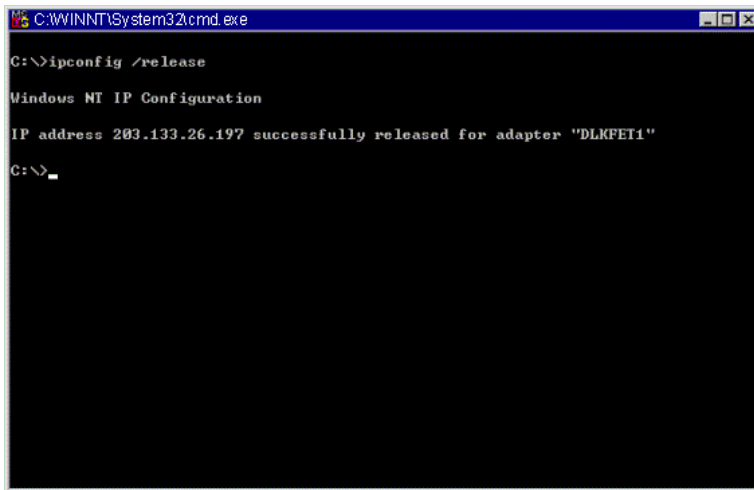

5. Type "ipconfig /renew", and press "Enter" on your keyboard to renew the IP. You can repeat the steps until your computer gets the correct IP.

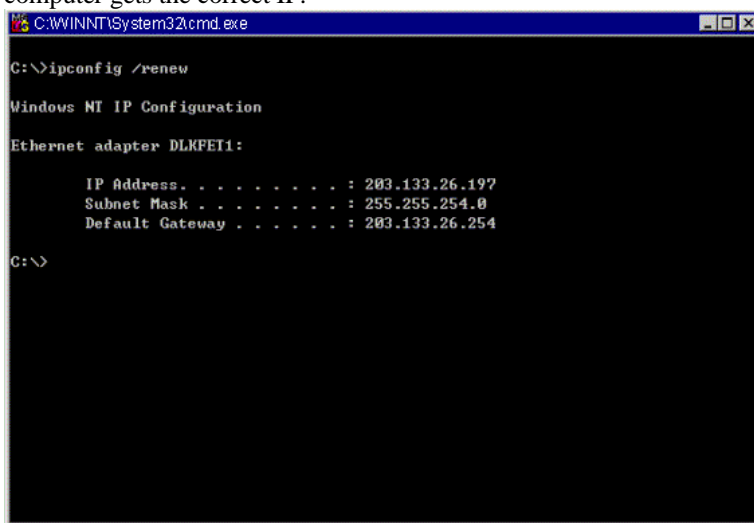

For Apple Macintosh

1. Click "Apple menu", point to "Control Panels", and click "TCP/IP" to open the "TCP/IP" window.

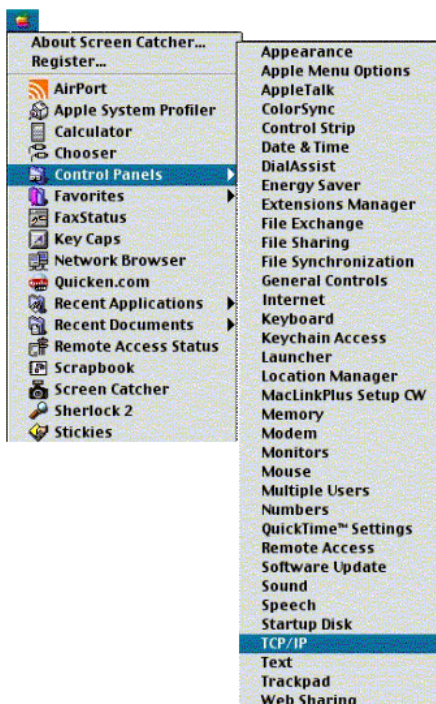

- If the iMac gets an invalid IP, select “Using DHCP Server” in “Configure” field. Click the “Close box” at the upper left corner to close the “TCP/IP” window.

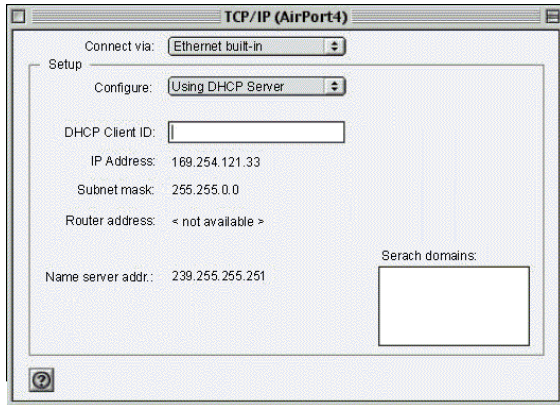

- Click the “Save” in the prompted message box.

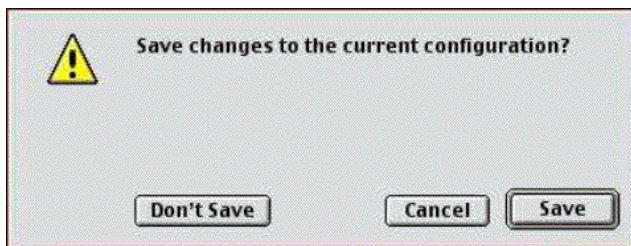

- You need to wait about 2 minutes and open “TCP/IP” window to see the new TCP/IP status.

Renew PC IP Address

There is a chance that your PC does not renew its IP address after cable modem is on line and the PC cannot access the Internet. Please follow the procedures below to renew PC' s IP address after the cable modem is on line.

- Click “Start“, point to “Run“, and click to open the “Run“ windows.

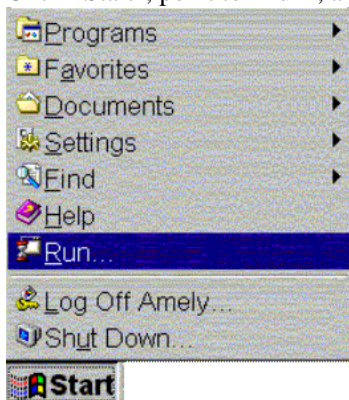

- Enter winipcfg in the “Open“ field. Click “OK“ to execute the winipcfg and show the “IP Configuration“ window.

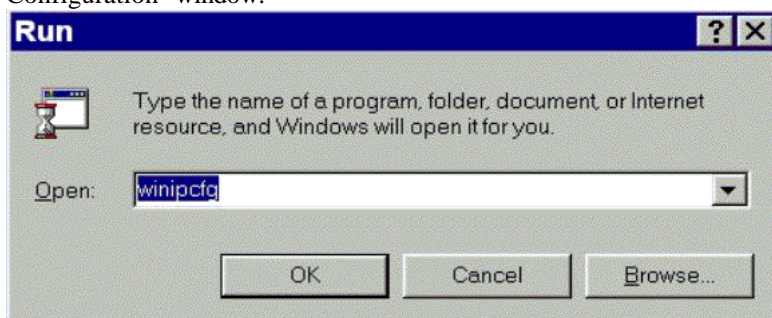

- Select the “Ethernet adapter“ to show the IP address. Press “Release“ and “Renew“ to get a new IP address

from your ISP's server.

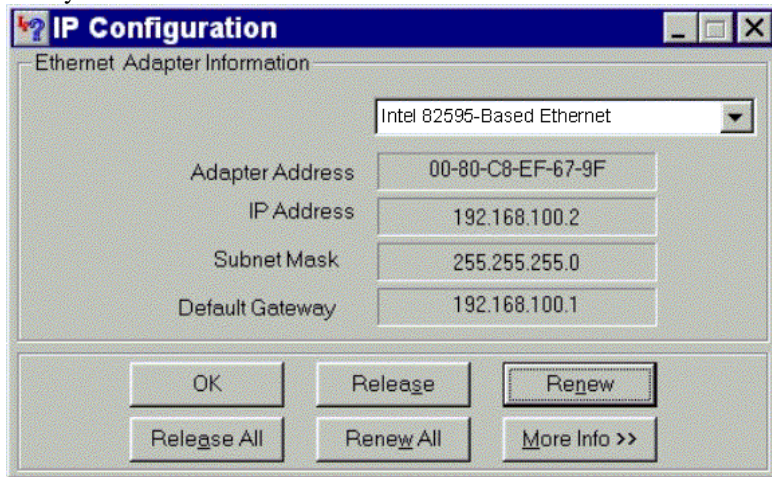

4. Select the "OK" to close the IP Configuration window.

Chapter 4: Web Configuration

Usin4g Web-Based Manager

Once your host PC is properly configured, please proceed as follows:

Start your web browser and type the private IP address of the cable modem in the URL field: **192.168.100.1**.

After connecting to the device, you will be prompted to enter username and password. By default, the username is **empty** and the password is **SA**. See the following example for running under Windows XP.

Status

This page shows the basic information of your cable modem such as name of your modem, serial number, MAC address, hardware version, software version, receive power level, transmit power level, cable modem status and so on.

Software

This page shows the basic software information such as software version for your reference.

WebSTAR
Scientific Atlanta

Status

Software Build Version
This page displays information on the current software.

Information	
Standard Specification Compliant	DOCSIS 1.0/1.1
Hardware Version	e000
Software Version	1.0.1r1
Cable Modem MAC Address	00:90:00:02:00:a0
Cable Modem Serial Number	sm1173294
CM certificate	Installed

Status	
System Up Time	0 days 00h:03m:21s
Network Access	Allowed
Cable Modem IP Address	10.0.50.112

Connection

The page shows the connection information about the access point in the status of WAN connection.

WebSTAR
Scientific Atlanta

Status

Connection
This page displays information on the status of WAN connection.

Startup Procedure			
Procedure	Status	Comment	
Acquire Downstream Channel	Locked		
Connectivity State	OK	Operational	
Boot State	OK	Operational	
Configuration File			
Security	Disabled	Disabled	

Downstream Channel			
Lock Status	Locked	Modulation	QAM64
Channel ID	1	Symbol rate	5056941
Downstream Frequency		Downstream Power	-3.8 dBmV
SNR	37.9 dB		

Upstream Channel			
Lock Status	Locked	Modulation	QPSK
Channel ID	1	Symbol rate	2560 Ksym/sec
Upstream Frequency		Upstream Power	36.75 dBmV

CM IP Address	Duration	Expires
-----	D: -- H: -- M: -- S: --	-----

Current System Time: THU SEP 19 15:06:00 2002

Security

If you are not satisfied with the password that the system gave you, you can change the password in this web page.

Please enter the new one on the right box to the Password. Then re-enter the password below that one for confirmation. Finally, click **Apply** to invoke this setting for the next time using.

If you don't want to use the password that you set and want to restore the factory default one, please click on the Yes radio button and click **Apply**.

WebSTAR
Scientific Atlanta

Status

Security
This page allows you to change access privileges and restore factory defaults.

Password

Re-Enter Password

Restore Factory Defaults Yes No

Wireless

To configure the wireless setting for the Access Point, please open this web page.

Basic

WebSTAR
Scientific Atlanta

Wireless

802.11b Basic
This page allows configuration of the Access Point parameters, including SSID and channel number.

Service Set Identifier (SSID)

New Channel:

Current Channel:

Encryption Mode:

Firmware Version:

Service Set Identifier (SSID): Type in the SSID for your service provider.

New Channel: Select the channel that you need.

Current Channel: The current channel that your access point is in.

Encryption Mode: It shows the encryption mode that you set on the Privacy web page.

Firmware version: It shows the firmware version that you have for your access point.

Privacy

To configure the WEP encryption, please open this web page

Encryption Mode:

Choose the encryption mode for your necessity.

Authentication:

The access point supports three authentication types: **Open System**, **Shared key** and **Both**. This should be considered with the WEP (Wired Equivalent Privacy) mechanism.

Default Key:

Select the number as the default key for WEP encryption.

Key 1 ~ Key 4:

Please type in the number that you want to set for the WEP encryption.

After you do any change in this page, please remember to click the **Apply** button to the bottom of the web page for invoke the settings to your system.

Advanced

This page allows you to have further configuration for the wireless settings.

Basic Data Rates:	It decides the speed of the management packet transmission.
Control Tx Rates:	It decides the speed of the data packet transmission.
Beacon Interval:	Type in the beacon interval number. The range is from 0 to 65535.
DTIM Interval:	Type in the DTIM interval number. The range is from 1 to 255.
Fragmentation Threshold:	It decides the packet size. If the packet size is over the number that you typed here, it will be fragmented automatically. The maximum number is 2346 that means no packet size will be fragmented.
RTS Threshold:	If the packet size is over the value that you type here, system will use RTS (Request To Send) mechanism to transmit the data.

After you do any change in this page, please remember to click the **Apply** button to the bottom of the web page for invoke the settings to your system.

Chapter 5: Access Internet through Cable Modem

For making sure that you can get into Internet successfully, please make sure the following first.

1. Make sure the connection (through Ethernet or USB) between the cable modem and your computer is OK.
2. Make sure the TCP/IP protocol is set properly.
3. Subscribe to Cable Television Company.

Accessing Internet

When you are sure all above is Ok, you can open the Browser (such as I.E.) to open the homepage for the browser. See the following example.

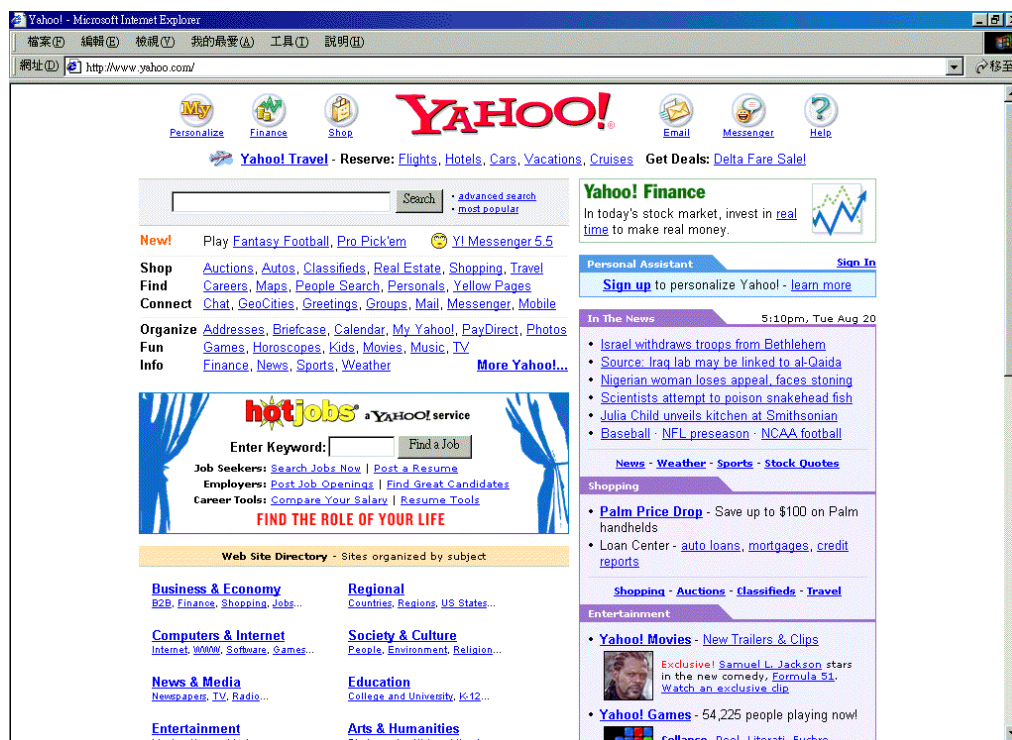

Chapter 6: Troubleshooting

If the suggested solutions in this section do not resolve your issue, contact your system administrator or Internet service provider.

Can I use the same cable line for TV and cable modem?

- A. Yes, the TV and cable modem uses the cable line. You need a splitter to use them at the same time. Ask Cable Company to install the splitter for you to avoid signal degradation.

My cable modem cannot get a solid green light on the Status LED when I connect the cable back.

- A. The cable modem lost the signal during the disconnection period and it will keep scanning for other available signals. When you connect the cable back, it might take a while to find the correct channel. You can power cycle the modem to speed up the process since the modem will remember the channel last time and it will start from that channel at startup.

Which port of the Ethernet hub should I connect to the modem if I need to connect multiple PCs to the modem?

- A. You should connect the modem to the up-link port of the hub. The link LED of the hub will be on.

How do I see my IP address?

- A. If you are using Windows 95/98/ME, the `wingpcfg` command will show you the IP address of the PC connected to the cable modem. Notice that even though you seem to get the same address all the time, it may still be a dynamic address.

Can I just connect the cable modem and two computers to a hub?

- A. Yes. You need to make sure you can get two IP addresses from your cable modem service provider. Connect the modem to the up-link port of the hub.

I have a cable modem. How can I make it work?

- A. Basically, modem is plug and play. You can just connect the modem and you are ready to go if you have the subscription. For ensure good signal for your cable modem, you should ask your cable provider to install the cable modem for you.

Can I switch between a notebook and PC using the same cable modem? Will there be a problem to obtain a DHCP IP address?

- A. This issue depends on how your cable modem service provider manages the modems. If you are using one of the cable modem service providers that register your PC based on the MAC address of the Ethernet card in the PC, then you will have to call them and have them change that entry every time you switch between the two. Ask them if you have a problem on this issue.

Appendix: Specifications

RF Specifications(US)

	<u>Downstream</u>	<u>Upstream</u>
■ Operating Frequency Range	88-860MHz	5-42MHz
■ Frequency Channel	HRC, IRC, STD	
■ Frequency Selection	Auto Scanning	Controlled by Head end
■ Bandwidth	6MHz	Programmable (200*N KHz) N=1, 2, 4, 8, 16
■ Characteristic Impedance	75Ω Nominal	75Ω Nominal
■ Signal Level Range	-15 to +15dBmV/64QAM -15 to +15dBmV/256QAM	+8 to +58dBmV/QPSK +8 to +55dBmV/16QAM
■ Modulation	64QAM/256QAM	QPSK/16QAM
■ Symbol Rate	5.056941/5.360537 Msym/sec	160/320/640/1280/2560 Ksym/sec
■ Maximum Bit Rate	42.88Mbps/256QAM 30.34Mbps/64QAM	10.24Mbps/16QAM 5.12Mbps/QPSK
■ Forward Error Correction (FEC)	RS (128,122)/Trellis	Reed Solomon
■ Bit Error Rate (BER)	1×10 ⁻⁸ @ C/N=23.5dB, 64QAM with FEC 1×10 ⁻⁸ @ C/N=30dB, 256QAM with FEC, received power = -6dBmV to +15dBmV 1x10 ⁻⁸ @ C/N=33dB, 256QAM with FEC, received power = -15dBmV to -6dBmV	

Wireless LAN

■ Data Encryption	64/128 bit WEP
■ Standard Compliance	IEEE 802.11b
■ Operating Frequency Range	2.4GHz (2400-2483.5MHz) ISM Band N.America/FCC: 2.412~2.462GHz (11Channels) Europe CE/ETSI: 2.412~2.472GHz (13Channels) Japan : 2.412~2.484GHz (14Channels)
■ Modulation	2.4 GHz Direct Sequence Spread Spectrum (DSSS) , CCK(11Mbps,5.5Mbps), DQPSK(2Mbps),DBPSK(1Mbps)
■ Regulation Domain	FCC / ETSI / IC / Spain / France / Telec
■ Numbers of selectable channels	Up to 14 (depend on Regulation Domain)
■ Antenna	2 internal PCB antenna
■ Media Access Protocol	CSMA/CA with ACK for uni-cast data frame CSMA/CA for multi-cast/broadcast data frame
■ Tx Data Rate	11 / 5.5 / 2 / 1 Mbps, Auto Fall-Back
■ Range in Open Space	11Mb/100m 5.5Mb/150m 2Mb/250m 1Mb/300m
■ Range in Closed Office	11Mb/35m 5.5Mb/40m 2Mb/45m 1Mb/50m
■ Receiver Sensitivity	-80 dbm @ 11Mbps

- Output Power Average 15 dbm
- Interface PCMCIA Type II (PCMCIA v2.1, 3.3V)

Network

- Network Protocol IP/TCP/UDP/ARP/ICMP/DHCP/TP/TFTP/SNMP/HTTP
- Packet Filtering Up to 253 CPE MAC filters, 32 LLC filters, 32 IP filters

Security and Encryption

- DOCSIS BPI X.509 Certificate/56-Bit DES
- Wireless LAN Authentication Open System & Shared Key
- Wireless LAN WEP RC4 with 64 / 128-bit Key Length

Standard Compliance

- Functional DOCSIS v1.0/v1.1, CableHome 1.0, Ethernet/IEEE 802.3U, USB v1.1, HPNA 2.0
- Network Management SNMP v1/v2c/v3, RFC1907 (System group and SNMP MIB), RFC2233 (Interface group), RFC2011 (ICMP group and IP group), RFC2013 (UDP group), RFC2665 (Ethernet MIB), RFC1493 (Bridge MIB), RFC2670 (RF MIB), RFC2669 (Cable Device MIB), RFC3083 (BPI-MIB), RFC2012 (TCP-MIB), USB MIB

Physical Interface

- To CPE Four ports Ethernet switch
USB Type B
HPNA RJ-11 connector
IEEE 802.11b Wireless LAN
- To CATV network Female F-Connector
- LEDs Power, Receive, Send, Cable, Ethernet 1, Ethernet 2, Ethernet 3, Ethernet 4, USB, HPNA, Wireless

Physical Specifications

- Dimensions W210 x D155 x H40 mm
- Weight: ?g

Electrical Specifications

- Input Power 12VDC +/- 10%
- Power Consumption 10W(Maximum) (?) @ operating

Environmental Specifications

- Operating Temperature 0°C to 40°C (32°F to 104°F)
- Storage Temperature -20°C to 70°C (-4°F to 158°F)
- Humidity up to 90% non-condensing

Regulatory Approvals and Compliance

- Agency & Regulatory FCC Part 15, Class B
CE, Class B
- Safety Approvals UL 1950