

F1A75-V EVO



Motherboard

E6697

First Edition (V1)

June 2011

Copyright © 2011 ASUSTeK Computer Inc. All Rights Reserved.

No part of this manual, including the products and software described in it, may be reproduced, transmitted, transcribed, stored in a retrieval system, or translated into any language in any form or by any means, except documentation kept by the purchaser for backup purposes, without the express written permission of ASUSTeK Computer Inc. ("ASUS").

Product warranty or service will not be extended if: (1) the product is repaired, modified or altered, unless such repair, modification or alteration is authorized in writing by ASUS; or (2) the serial number of the product is defaced or missing.

ASUS PROVIDES THIS MANUAL "AS IS" WITHOUT WARRANTY OF ANY KIND, EITHER EXPRESS OR IMPLIED, INCLUDING BUT NOT LIMITED TO THE IMPLIED WARRANTIES OR CONDITIONS OF MERCHANTABILITY OR FITNESS FOR A PARTICULAR PURPOSE. IN NO EVENT SHALL ASUS, ITS DIRECTORS, OFFICERS, EMPLOYEES OR AGENTS BE LIABLE FOR ANY INDIRECT, SPECIAL, INCIDENTAL, OR CONSEQUENTIAL DAMAGES (INCLUDING DAMAGES FOR LOSS OF PROFITS, LOSS OF BUSINESS, LOSS OF USE OR DATA, INTERRUPTION OF BUSINESS AND THE LIKE), EVEN IF ASUS HAS BEEN ADVISED OF THE POSSIBILITY OF SUCH DAMAGES ARISING FROM ANY DEFECT OR ERROR IN THIS MANUAL OR PRODUCT.

SPECIFICATIONS AND INFORMATION CONTAINED IN THIS MANUAL ARE FURNISHED FOR INFORMATIONAL USE ONLY, AND ARE SUBJECT TO CHANGE AT ANY TIME WITHOUT NOTICE, AND SHOULD NOT BE CONSTRUED AS A COMMITMENT BY ASUS. ASUS ASSUMES NO RESPONSIBILITY OR LIABILITY FOR ANY ERRORS OR INACCURACIES THAT MAY APPEAR IN THIS MANUAL, INCLUDING THE PRODUCTS AND SOFTWARE DESCRIBED IN IT.

Products and corporate names appearing in this manual may or may not be registered trademarks or copyrights of their respective companies, and are used only for identification or explanation and to the owners' benefit, without intent to infringe.

Offer to Provide Source Code of Certain Software

This product may contain copyrighted software that is licensed under the General Public License ("GPL") and under the Lesser General Public License Version ("LGPL"). The GPL and LGPL licensed code in this product is distributed without any warranty. Copies of these licenses are included in this product.

You may obtain the complete corresponding source code (as defined in the GPL) for the GPL Software, and/or the complete corresponding source code of the LGPL Software (with the complete machine-readable "work that uses the Library") for a period of three years after our last shipment of the product including the GPL Software and/or LGPL Software, which will be no earlier than December 1, 2011, either

(1) for free by downloading it from <http://support.asus.com/download>;

or

(2) for the cost of reproduction and shipment, which is dependent on the preferred carrier and the location where you want to have it shipped to, by sending a request to:

ASUSTeK Computer Inc.
Legal Compliance Dept.
15 Li Te Rd.,
Beitou, Taipei 112
Taiwan

In your request please provide the name, model number and version, as stated in the About Box of the product for which you wish to obtain the corresponding source code and your contact details so that we can coordinate the terms and cost of shipment with you.

The source code will be distributed WITHOUT ANY WARRANTY and licensed under the same license as the corresponding binary/object code.

This offer is valid to anyone in receipt of this information.

ASUSTeK is eager to duly provide complete source code as required under various Free Open Source Software licenses. If however you encounter any problems in obtaining the full corresponding source code we would be much obliged if you give us a notification to the email address gpl@asus.com, stating the product and describing the problem (please do NOT send large attachments such as source code archives etc to this email address).

Contents

Notices.....	vi
Safety information	vii
About this guide	viii
F1A75-V EVO specifications summary.....	ix

Chapter 1 Product introduction

1.1	Welcome!	1-1
1.2	Package contents.....	1-1
1.3	Special features.....	1-1
	1.3.1 Product highlights	1-1
	1.3.2 Dual Intelligent Processors 2 – DIGI+ VRM.....	1-2
	1.3.3 ASUS Digital Power Design.....	1-3
1.4	Before you proceed	1-6
1.5	Motherboard overview.....	1-7
	1.5.1 Placement direction	1-7
	1.5.2 Screw holes	1-7
	1.5.3 Motherboard layout.....	1-8
	1.5.4 Layout contents.....	1-8
1.6	Accelerated Processing Unit (APU)	1-9
	1.6.1 Installing the APU.....	1-9
	1.6.2 Installing the heatsink and fan	1-11
1.7	System memory	1-12
	1.7.1 Overview	1-12
	1.7.2 Memory configurations.....	1-13
	1.7.3 Installing a DIMM	1-14
	1.7.4 Removing a DIMM	1-14
1.8	Expansion slots.....	1-15
	1.8.1 Installing an expansion card	1-15
	1.8.2 Configuring an expansion card	1-15
	1.8.3 PCI slots.....	1-15
	1.8.4 PCI Express 2.0 x1 slots.....	1-15
	1.8.5 PCI Express 2.0 x16 slots.....	1-15
1.9	Jumpers	1-16
1.10	Connectors	1-17
	1.10.1 Rear panel ports	1-17
	1.10.2 Internal connectors	1-19

Contents

1.11	Onboard switch	1-25
1.12	Onboard LEDs	1-28
1.13	Software support	1-30
1.13.1	Installing an operating system	1-30
1.13.2	Support DVD information	1-30

Chapter 2 BIOS information

2.1	Managing and updating your BIOS	2-1
2.1.1	ASUS Update utility	2-1
2.1.2	ASUS EZ Flash 2	2-2
2.1.3	ASUS CrashFree BIOS 3 utility	2-3
2.1.4	ASUS BIOS Updater	2-4
2.2	BIOS setup program	2-7
2.3	Main menu	2-11
2.3.1	System Language [English]	2-11
2.3.2	System Date [Day xx/xx/xxxx]	2-11
2.3.3	System Time [xx:xx:xx]	2-11
2.3.4	Security	2-11
2.4	Ai Tweaker menu	2-13
2.4.1	Ai Overclock Tuner [Auto]	2-14
2.4.2	Memory Frequency [Auto]	2-14
2.4.3	APU Multiplier [Auto]	2-14
2.4.4	EPU Power Saving Mode [Disabled]	2-14
2.4.5	OC Tuner	2-15
2.4.6	DRAM Timing Control	2-15
2.4.7	CPU Voltage [Offset Mode]	2-15
2.4.8	DRAM Voltage [Auto]	2-16
2.4.9	SB 1.1V Voltage [Auto]	2-16
2.4.10	1.1Vsb Voltage [Auto]	2-16
2.4.11	APU1.2V Voltage [Auto]	2-16
2.4.12	VDDA Voltage [Auto]	2-16
2.4.13	DIGI + VRM	2-16
2.4.14	APU Spread Spectrum [Auto]	2-17
2.5	Advanced menu	2-18
2.5.1	CPU Configuration	2-18
2.5.2	SATA Configuration	2-19

Contents

2.5.3	USB Configuration	2-19
2.5.4	NB Configuration.....	2-20
2.5.5	Onboard Devices Configuration.....	2-20
2.5.6	APM	2-21
2.6	Monitor menu	2-22
2.6.1	CPU Temperature / MB Temperature [xxx°C/xxx°F].....	2-23
2.6.2	CPU / Chassis / Power Fan Speed [xxxx RPM] or [Ignore] / [N/A].....	2-23
2.6.3	CPU Q-Fan Control [Disabled].....	2-23
2.6.4	Chassis Q-Fan Control [Disabled]	2-24
2.6.5	CPU Voltage, 3.3V Voltage, 5V Voltage, 12V Voltage ..	2-24
2.6.6	Anti Surge Support [Enabled]	2-24
2.7	Boot menu	2-25
2.7.1	Bootup NumLock State [On]	2-25
2.7.2	Full Screen Logo [Enabled].....	2-25
2.7.3	Wait for 'F1' If Error [Enabled].....	2-25
2.7.4	Option ROM Messages [Force BIOS].....	2-26
2.7.5	Setup Mode [EZ Mode]	2-26
2.7.6	Boot Option Priorities	2-26
2.7.7	Boot Override.....	2-26
2.8	Tools menu	2-27
2.8.1	ASUS EZ Flash 2 Utility	2-27
2.8.2	ASUS O.C. Profile.....	2-27
2.8.3	ASUS SPD Information	2-27
2.9	Exit menu	2-28

Notices

Federal Communications Commission Statement

This device complies with Part 15 of the FCC Rules. Operation is subject to the following two conditions:

- This device may not cause harmful interference, and
- This device must accept any interference received including interference that may cause undesired operation.

This equipment has been tested and found to comply with the limits for a Class B digital device, pursuant to Part 15 of the FCC Rules. These limits are designed to provide reasonable protection against harmful interference in a residential installation. This equipment generates, uses and can radiate radio frequency energy and, if not installed and used in accordance with manufacturer's instructions, may cause harmful interference to radio communications. However, there is no guarantee that interference will not occur in a particular installation. If this equipment does cause harmful interference to radio or television reception, which can be determined by turning the equipment off and on, the user is encouraged to try to correct the interference by one or more of the following measures:

- Reorient or relocate the receiving antenna.
- Increase the separation between the equipment and receiver.
- Connect the equipment to an outlet on a circuit different from that to which the receiver is connected.
- Consult the dealer or an experienced radio/TV technician for help.



The use of shielded cables for connection of the monitor to the graphics card is required to assure compliance with FCC regulations. Changes or modifications to this unit not expressly approved by the party responsible for compliance could void the user's authority to operate this equipment.

Canadian Department of Communications Statement

This digital apparatus does not exceed the Class B limits for radio noise emissions from digital apparatus set out in the Radio Interference Regulations of the Canadian Department of Communications.

This class B digital apparatus complies with Canadian ICES-003.

ASUS Recycling/Takeback Services

ASUS recycling and takeback programs come from our commitment to the highest standards for protecting our environment. We believe in providing solutions for you to be able to responsibly recycle our products, batteries, other components as well as the packaging materials. Please go to <http://csr.asus.com/english/Takeback.htm> for the detailed recycling information in different regions.

REACH

Complying with the REACH (Registration, Evaluation, Authorisation, and Restriction of Chemicals) regulatory framework, we published the chemical substances in our products at ASUS REACH website at <http://csr.asus.com/english/REACH.htm>.



DO NOT throw the motherboard in municipal waste. This product has been designed to enable proper reuse of parts and recycling. This symbol of the crossed out wheeled bin indicates that the product (electrical and electronic equipment) should not be placed in municipal waste. Check local regulations for disposal of electronic products.



DO NOT throw the mercury-containing button cell battery in municipal waste. This symbol of the crossed out wheeled bin indicates that the battery should not be placed in municipal waste.

Safety information

Electrical safety

- To prevent electric shock hazard, disconnect the power cable from the electric outlet before relocating the system.
- When adding or removing devices to or from the system, ensure that the power cables for the devices are unplugged before the signal cables are connected. If possible, disconnect all power cables from the existing system before you add a device.
- Before connecting or removing signal cables from the motherboard, ensure that all power cables are unplugged.
- Seek professional assistance before using an adapter or extension cord. These devices could interrupt the grounding circuit.
- Ensure that your power supply is set to the correct voltage in your area. If you are not sure about the voltage of the electrical outlet you are using, contact your local power company.
- If the power supply is broken, do not try to fix it by yourself. Contact a qualified service technician or your retailer.

Operation safety

- Before installing the motherboard and adding devices on it, carefully read all the manuals that came with the package.
- Before using the product, ensure that all cables are correctly connected and the power cables are not damaged. If you detect any damage, contact your dealer immediately.
- To avoid short circuits, keep paper clips, screws, and staples away from connectors, slots, sockets and circuitry.
- Avoid dust, humidity, and temperature extremes. Do not place the product in any area where it may become wet.
- Place the product on a stable surface.
- If you encounter technical problems with the product, contact a qualified service technician or your retailer.

About this guide

This user guide contains the information you need when installing and configuring the motherboard.

How this guide is organized

This guide contains the following parts:

- **Chapter 1: Product introduction**

This chapter describes the features of the motherboard and the new technology it supports.

- **Chapter 2: BIOS information**

This chapter tells how to change system settings through the BIOS Setup menus. Detailed descriptions of the BIOS parameters are also provided.

Conventions used in this guide

To ensure that you perform certain tasks properly, take note of the following symbols used throughout this manual.



DANGER/WARNING: Information to prevent injury to yourself when trying to complete a task.



CAUTION: Information to prevent damage to the components when trying to complete a task.



IMPORTANT: Instructions that you **MUST** follow to complete a task.



NOTE: Tips and additional information to help you complete a task.

Where to find more information

Refer to the following sources for additional information and for product and software updates.

1. **ASUS websites**

The ASUS website provides updated information on ASUS hardware and software products. Refer to the ASUS contact information.

2. **Optional documentation**

Your product package may include optional documentation, such as warranty flyers, that may have been added by your dealer. These documents are not part of the standard package.

Typography

Bold text

Indicates a menu or an item to select.

Italics

Used to emphasize a word or a phrase.

<Key>

Keys enclosed in the less-than and greater-than sign means that you must press the enclosed key.

Example: <Enter> means that you must press the Enter or Return key.

<Key1>+<Key2>+<Key3>

If you must press two or more keys simultaneously, the key names are linked with a plus sign (+).

Example: <Ctrl>+<Alt>+<D>

F1A75-V EVO specifications summary

APU	<p>AMD® A- & E2- series accelerated processors with AMD® Radeon™ HD 6000 series graphics, up to 4 CPU cores, FM1 package</p> <p>AMD® Turbo Core Technology 2.0 support</p> <p>DirectX® 11 Support</p> <p>* The AMD® Turbo Core Technology 2.0 support depends on the APU types.</p> <p>** Refer to www.asus.com for the AMD® APU support list</p>
Chipset	<p>AMD® A75 FCH (Hudson D3)</p>
Memory	<p>Dual-channel memory architecture</p> <p>4 x 240-pin DIMM slots support maximum 64GB unbuffered non-ECC DDR3 1866/1600/1333/1066 MHz memory modules</p> <p>* The maximum 64GB memory capacity can be supported with 16GB or above DIMMs. ASUS will update the memory QVL once the DIMMs are available in the market.</p> <p>** Refer to www.asus.com for the latest Memory QVL (Qualified Vendors List).</p> <p>*** When you install a total memory of 4GB capacity or more, Windows® 32-bit operating system may only recognize less than 3GB. We recommend a maximum of 3GB system memory if you are using a Windows® 32-bit operating system.</p>
Graphics	<p>Integrated AMD® Radeon™ HD 6000 series graphics in the Llano APU</p> <p>Multi-VGA output support: DisplayPort, HDMI, DVI-D, D-Sub port</p> <ul style="list-style-type: none"> - Supports DisplayPort with max. resolution 2560 x 1600 @60Hz - Supports HDMI with max. resolution up to 1920 x 1200 @60Hz - Supports single-link DVI with max. resolution up to 1920 x 1200 @60Hz - Supports D-Sub with max. resolution up to 1920 x 1600 @60Hz <p>- Supports Microsoft® DirectX 11</p> <p>Supports AMD® Dual Graphics</p> <p>* Refer to www.amd.com for the discrete GPUs that support Dual Graphics.</p>
Expansion slots	<p>2 x PCIe 2.0 x16 slots (Single @x16 or dual @x8 / x8 mode)</p> <p>1 x PCIe 2.0 x16 slots (black, max. @x4 mode)</p> <p>2 x PCIe 2.0 x1 slots</p> <p>2 x PCI slots</p> <p>* The PCIe x16_3 slot shares bandwidth with PCIe x1_2 slot. Due to the CrossFireX™ limitation, DO NOT use the PCIe x1_2 slot when you install two CrossfireX™ graphic cards on both the PCIe x16_1 and PCIe x16_3 slots to set up a CrossFireX™ configuration.</p>
LAN	<p>Realtek® RTL8111E PCIe Gigabit LAN controller</p>

(continued on the next page)

F1A75-V EVO specifications summary

Storage	<p>AMD® A75 FCH southbridge:</p> <ul style="list-style-type: none"> - 6 x Serial ATA 6.0Gb/s connectors (gray) support RAID 0, RAID 1, RAID 10 and JBOD configurations <p>Asmedia® PCIe SATA 6Gb/s controller:</p> <ul style="list-style-type: none"> - 1 x Serial ATA 6Gb/s connector (navy blue) - 1 eSerial ATA 6Gb/s at the back I/O
Audio	<p>ALC892 8-channel High Definition Audio CODEC</p> <ul style="list-style-type: none"> - Supports Jack-Detection, Multi-Streaming, and Front Panel Jack-Retasking - Supports S/PDIF out interface at the back I/O
USB	<p>AMD® A75 FCH southbridge:</p> <ul style="list-style-type: none"> - 10 x USB 2.0/1.1 ports (8 ports at the front panel, 2 ports at the back panel) - 4 x USB 3.0 ports (2 ports at the front panel, 2 ports at the back panel) (blue) <p>Asmedia® PCIe USB3.0 controller:</p> <ul style="list-style-type: none"> - 2 x USB 3.0/2.0 ports (at the back panel)
ASUS unique features	<p>ASUS Dual Intelligent Processors II with DIGI+ VRM</p> <ul style="list-style-type: none"> - ASUS TPU: Auto Tuning, TurboV and TPU switch - ASUS EPU: EPU, EPU switch <p>ASUS Digital Power Design</p> <ul style="list-style-type: none"> - Industry leading Digital 6+2 Phase Power Design <p>ASUS Exclusive Features</p> <ul style="list-style-type: none"> - MemOK! - ASUS AI Suite II - AI Charger+ - ASUS Anti-Surge Protection - ASUS UEFI BIOS EZ Mode featuring graphics user interface <p>ASUS Quiet Thermal Solution</p> <ul style="list-style-type: none"> - ASUS Fanless Design: Stylish heat-pipe solution - ASUS Fan Xpert <p>ASUS EZ DIY</p> <ul style="list-style-type: none"> - ASUS Q-Shield, Q-Slot, Q-Connector - ASUS CrashFree BIOS 3 - ASUS EZ Flash 2 - ASUS MyLogo 2™ - Multi-language BIOS
Back Panel I/O ports	<p>1 x PS/2 keyboard / mouse combo port 1 x DisplayPort 1 x HDMI port 1 x DVI-D port 1 x D-Sub port 1 x Optical S/PDIF port 1 x LAN (RJ-45) port 1 x eSATA port 2 x USB 2.0/1.1 ports 4 x USB 3.0 ports 8-channel audio 6 Jacks</p>

F1A75-V EVO specifications summary

Special features	100% All high quality conductive polymer capacitors
ASUS exclusive overclocking features	<p>Intelligent overclocking tools:</p> <ul style="list-style-type: none"> - TPU Switch - Auto Tuning <p>Precision Tweaker 2</p> <ul style="list-style-type: none"> - vCore: Adjustable CPU voltage at 0.00625V increment - vDRAM Bus: Adjustable DRAM voltage at 0.01V increment - vFCH: Adjustable FCH voltage at 0.01V increment <p>SFS (Stepless Frequency Selection):</p> <ul style="list-style-type: none"> - PCIe frequency tuning from 100MHz up to 200MHz at 1MHz increment <p>Overclocking Protection:</p> <ul style="list-style-type: none"> - ASUS C.P.R
Internal I/O connectors / buttons / switches	<p>4 x USB 2.0/1.1 connectors support additional 8 USB 2.0/1.1 ports</p> <p>1 x USB 3.0 connector supports additional 2 USB 3.0 ports</p> <p>7 x SATA 6.0Gb/s connectors (6 x gray, 1 x navy blue)</p> <p>1 x COM connector</p> <p>1 x CPU fan connector</p> <p>2 x Chassis fan connectors</p> <p>1 x Power fan connector</p> <p>1 x High Definition front panel audio connector</p> <p>1 x S/PDIF output connector</p> <p>1 x System panel connector</p> <p>1 x 24-pin EATX power connector</p> <p>1 x 8-pin ATX 12V power connector</p> <p>1 x MemOK! button</p> <p>1 x EPU switch</p> <p>1 x TPU switch</p>
BIOS	32Mb Flash ROM, UEFI BIOS, PnP, DMI 2.0, WfM 2.0, ACPI V2.0a, SM BIOS 2.6
Accessories	<p>2 x Serial ATA 6.0Gb/s cables</p> <p>1 x Q-Shield</p> <p>1 x Q-Connector (retail version only)</p> <p>1 x User Manual</p> <p>1 x Support DVD</p>
Support DVD	<p>Drivers</p> <p>ASUS Update</p> <p>ASUS utilities</p> <p>Anti-Virus software (OEM version)</p>
Form factor	ATX form factor: 12 in x 9.6 in (30.5 cm x 24.4 cm)

*Specifications are subject to change without notice.



Chapter 1

Product introduction

1.1 Welcome!

Thank you for buying an ASUS® F1A75-V EVO motherboard!

The motherboard delivers a host of new features and latest technologies, making it another standout in the long line of ASUS quality motherboards!

Before you start installing the motherboard, and hardware devices on it, check the items in your package with the list below.

1.2 Package contents

Check your motherboard package for the following items.

Motherboard	ASUS F1A75-V EVO motherboard
Cables	2 x Serial ATA 6.0Gb/s cables
Accessories	1 x Q-Shield 1 x Q-Connector (retail version only)
Application DVD	ASUS motherboard Support DVD
Documentations	User Manual



If any of the above items is damaged or missing, contact your retailer.

1.3 Special features

1.3.1 Product highlights

AMD® A- & E2- series accelerated processors with AMD® Radeon™ HD 6000 series graphics

This motherboard supports AMD® A- & E2- series accelerated processor with AMD® Radeon™ HD 6000 series graphics. This revolutionary APU (Accelerated Processing Unit) combines processing power and advanced DirectX 11 graphics in one small, energy-efficient design to enable accelerated performance and an industry-leading visual experience. It features Dual-channel DDR3 memory support and accelerates data transfer rate up to 5GT/s.

AMD® A75 FCH (Hudson D3) Chipset

AMD® A75 FCH (Hudson D3) is designed to support up to 5GT/s interface speed and PCI Express™ 2.0 x 16 (at x4 speed) graphics. It supports 6 x SATA 6Gb/s ports and 4 x USB 3.0 Ports.



ATI® CrossFireX™ Technology

ATI's CrossFireX™ boosts image quality along with rendering speed, eliminating the need to scale down screen resolution to get high quality images. CrossFireX™ allows higher antialiasing, anisotropic filtering, shading, and texture settings. Adjust your display configurations, experiment with the advanced 3D settings, and check the effects with a real-time 3D-rendered previews within ATI Catalyst™ Control Center.



USB 3.0 support

Experience ultra-fast data transfer at 4.8Gbps with USB 3.0 – the latest connectivity standard. Built to connect easily with next-generation components and peripherals, USB 3.0 transfers data 10x faster and is also backward compatible with USB 2.0 components.



Native SATA 6.0 Gb/s support

The AMD® A75 FCH natively supports next-generation Serial ATA (SATA) storage interface, this motherboard delivers up to 6.0 Gb/s data transfer rates. Additionally, get enhanced scalability, faster data retrieval, double the bandwidth of current bus systems.



100% All High-quality Conductive Polymer Capacitors

This motherboard uses all high-quality conductive polymer capacitors for durability, improved lifespan, and enhanced thermal capacity.

1.3.2 Dual Intelligent Processors 2 – DIGI+ VRM

The world's first Dual Intelligent Processors from ASUS pioneered the use of two onboard chips - TPU (TurboV Processing Unit) and EPU (Energy Processing Unit). Its new generation of Dual Intelligent Processors 2 with DIGI+ VRM launches power delivery into a digital standard with a programmable microprocessor that perfectly serves power signal, eliminating digital-to-analog conversion lag. It's the most precise power delivery available providing the best in class power efficiency, greater performance, and rock solid stability. With ASUS DIGI+ VRM, users can easily adjust power phase performance and system voltages via diverse settings to maximize overall performance and overclocking potential.

TPU

Unleash your performance with ASUS' simple onboard switch or AI Suite II utility. ASUS Auto tuning feature can automatically optimize the system for fast, yet stable clock speeds, and the TurboV gives you the freedom to adjust APU Multiplier to optimize performance under varied system conditions.

EPU

Tap into the world's first real time PC power saving engine through a simple onboard switch or AI Suite II utility. Get total system-wide energy optimization by automatically detecting current PC loadings and intelligently moderating power consumption. This also reduces fan noise and extends component longevity.

1.3.3 ASUS Digital Power Design

DIGI+ VRM

The world's first Dual Intelligent Processors from ASUS pioneered the use of two onboard chips - TPU (TurboV Processing Unit) and EPU (Energy Processing Unit). New generation Dual Intelligent Processors 2 with DIGI+ VRM launch power delivery into a digital standard. It features a digital programmable microprocessor onboard to perfectly match digital power signal, eliminating digital-to-analog conversion lag. The precise power delivery minimizes power transfer loss to provide highest power efficiency, greater performance, and rock solid stability with the most flexible power adjustment than traditional analog power design. With ASUS DIGI+ VRM, users can easily adjust power phase management voltages and frequency modulation via diverse settings through BIOS tunings and the exclusive user interface. It increases overclocking range while performance reaches its full potential.

1.3.4 ASUS Exclusive Features



ASUS TurboV

Feel the adrenaline rush of real-time OC-now a reality with the ASUS TurboV. This easy OC tool allows you to overclock without exiting or rebooting the OS; and its user-friendly interface makes overclock with just a few clicks away. Moreover, the ASUS OC profiles in TurboV provides the best O.C. settings in different scenarios.



Auto Tuning

Auto Tuning is an intelligent tool that automates overclocking to achieve a total system level up. This tool also provides stability testing. Even O.C. beginners can achieve extreme yet stable overclocking results with Auto Tuning!



MemOK!

MemOK! quickly ensures memory boot compatibility. This remarkable memory rescue tool requires a mere push of the button to patch memory issues. MemOK! determines failsafe settings and dramatically improves your system boot success. Get your system up and running in no time.

ASUS UEFI BIOS (EZ Mode)

The new ASUS UEFI BIOS is an Unified Extensible Firmware Interface that offers a user-friendly interface that goes beyond traditional keyboard-only BIOS controls to enable more flexible and convenient mouse input. Users can easily navigate the new UEFI BIOS with the same smoothness as their operating system. It natively supports hard drives larger than 2.2TB in 64-bit, with full storage space utilization, helping deliver far more exciting computing than traditional BIOS versions.

The exclusive EZ Mode displays frequently-accessed setup info, while the Advanced Mode is for experienced performance enthusiasts that demand far more intricate system settings.



ASUS Anti-Surge Protection

This special design protects expensive devices and the motherboard from damage caused by power surges from switching power supply unit (PSU).



AI Suite II

With its fast user-friendly interface, ASUS AI Suite II consolidates all the exclusive ASUS features into one simple to use software package. It allows you to supervise overclocking, energy management, fan speed control, and voltage and sensor readings. This all-in-one software offers diverse and ease to use functions, with no need to switch back and forth between different utilities.

Ai Charger+

ASUS Ai Charger+, the latest Ai Charger* version, brings you to a new level of USB3.0 fast charging experience. With its easy and user-friendly interface, you can not only easily charge iPod, iPhone and iPad, but also BC 1.1** standard mobile devices three times*** as fast as before.



* Ai Charger is ASUS unique fast-charging software which supports iPod, iPhone and iPad.

** Check your USB mobile device manufacturer if it fully supports the BC 1.1 function.

***The actual charging speed may vary with your USB device's conditions.



Fanless Design: stylish heatpipe solution

The stylish heatpipe features a 0-dB thermal solution that offers users a noiseless PC environment. Not only the beautiful shape upgrades the visual enjoyment for motherboard users, but also the heatsink design lowers the temperature of the chipset and power phase area through high efficient heat-exchange. Combined with usability and aesthetics, the ASUS stylish heatpipe will give users an extremely silent and cooling experience with the elegant appearance!



Fan Xpert

ASUS Fan Xpert intelligently allows you to adjust the CPU fan speed according to different ambient temperatures caused by different climate conditions in different geographic regions and your PC's loading. The built-in variety of useful profiles offer flexible controls of fan speed to achieve a quiet and cool environment.

ASUS Q-Design

ASUS Q-Design enhances your DIY experience. All of Q-Shield, Q-Slot and Q-Connector design speed up and simplify the DIY process!



ASUS Q-Shield

ASUS Q-Shield's special design makes it convenient and easy to install on your motherboard. With better electric conductivity, it ideally protects your motherboard against static electricity and shields it against Electronic Magnetic Interference (EMI).



ASUS EZ Flash 2

ASUS EZ Flash 2 is a user-friendly utility that allows you to update the BIOS without using a bootable floppy disk or an OS-based utility.



ASUS MyLogo 2™

Turn your favorite photos into 256-color boot logos to personalize your system.



ASUS CrashFree BIOS 3

ASUS CrashFree BIOS 3 is an auto-recovery tool that allows you to restore a corrupted BIOS file using the bundled support DVD or a USB flash disk that contains the BIOS file.



C.P.R. (CPU Parameter Recall)

The BIOS C.P.R. feature automatically restores the CPU default settings when the system hangs due to overclocking failure. C.P.R. eliminates the need to open the system chassis and clear the RTC data. Simply shut down and reboot the system, and the BIOS automatically restores the CPU parameters to their default settings.



ErP ready

The motherboard is European Union's Energy-related Products (ErP) ready, and ErP requires products to meet certain energy efficiency requirements in regards to energy consumptions. This is in line with ASUS vision of creating environment-friendly and energy-efficient products through product design and innovation to reduce carbon footprint of the product and thus mitigate environmental impacts.

1.4 Before you proceed

Take note of the following precautions before you install motherboard components or change any motherboard settings.



- Unplug the power cord from the wall socket before touching any component.
 - Before handling components, use a grounded wrist strap or touch a safely grounded object or a metal object, such as the power supply case, to avoid damaging them due to static electricity.
 - Hold components by the edges to avoid touching the ICs on them.
 - Whenever you uninstall any component, place it on a grounded antistatic pad or in the bag that came with the component.
 - Before you install or remove any component, switch off the ATX power supply and detach its power cord. Failure to do so may cause severe damage to the motherboard, peripherals, or components.
-

1.5 Motherboard overview

1.5.1 Placement direction

When installing the motherboard, ensure that you place it into the chassis in the correct orientation. The edge with external ports goes to the rear part of the chassis as indicated in the image below.

1.5.2 Screw holes

Place nine screws into the holes indicated by circles to secure the motherboard to the chassis.



DO NOT overtighten the screws! Doing so can damage the motherboard.

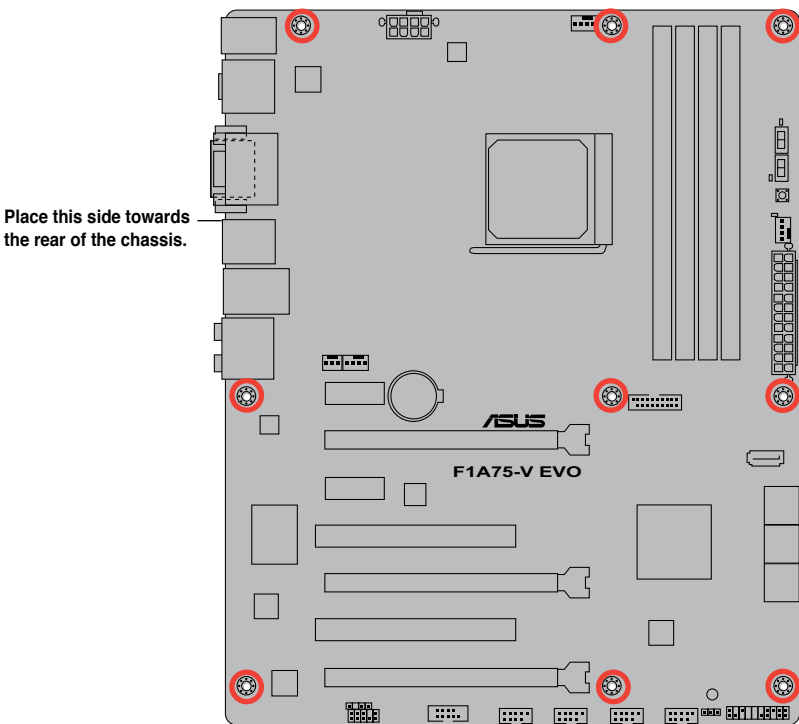

1.5.3 Motherboard layout

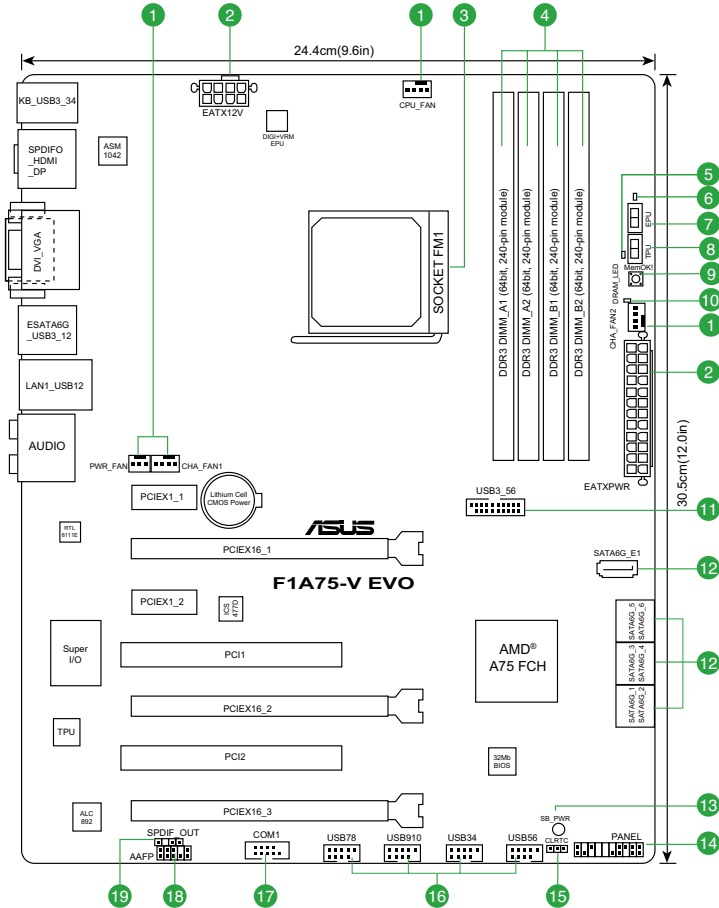

1.5.4 Layout contents

Connectors/Jumpers/Slots/LED	Page	Connectors/Jumpers/Slots/LED	Page
1. Power, CPU and chassis fan connectors (3-pin PWR_FAN, 4-pin CPU_FAN, and 4-pin CHA_FAN1/2)	1-19	11. USB 3.0 connector (20-1 pin USB3_56)	1-27
2. ATX power connectors (24-pin EATXPWR, 8-pin EATX12V)	1-20	12. SATA 6.0Gb/s connectors (7-pin SATA6G_E1, SATA 6G 1~6)	1-21
3. AMD FM1 socket	1-9	13. Standby power LED (SB_PWR)	1-22
4. DDR3 DIMM slots	1-12	14. System panel connector (20-8 pin PANEL)	1-16
5. TPU LED (ELED730)	1-27	15. Clear RTC RAM (3-pin CLRRTC)	1-24
6. EPU LED (ELED740)	1-28	16. USB 2.0 connectors (10-1 pin USB3~10)	1-24
7. EPU switch	1-26	17. Serial port connector (10-1 pin COM1)	1-21
8. TPU switch	1-26	18. Front panel audio connector (10-1 pin AAFP)	1-23
9. MemOK! switch	1-25	19. Digital audio connector (4-1 pin SPDIF_OUT)	1-23
10. DRAM LED (DRAM_LED)	1-27		

1.6 Accelerated Processing Unit (APU)

This motherboard comes with an FM1 socket designed for AMD® A- & E2- series accelerated processors with AMD® Radeon™ HD 6000 series graphics.



Ensure that you use a APU designed for the FM1 socket. The APU fits in only one correct orientation. **DO NOT** force the APU into the socket to prevent bending the pins and damaging the APU!

1.6.1 Installing the APU

To install a APU:

1. Locate the FM1 socket on the motherboard.

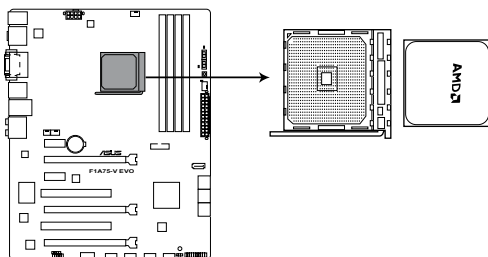

F1A75-V EVO APU socket FM1

2. Press the lever sideways to unlock the socket, then lift it up to a 90°-100° angle.

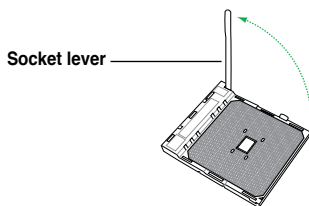

Ensure that the socket lever is lifted up to a 90°-100° angle; otherwise, the APU will not fit in completely.

3. Position the APU above the socket such that the APU corner with the gold triangle matches the socket corner with a small triangle.
4. Carefully insert the APU into the socket until it fits in place.



The APU fits only in one correct orientation. **DO NOT** force the APU into the socket to prevent bending the pins and damaging the APU!

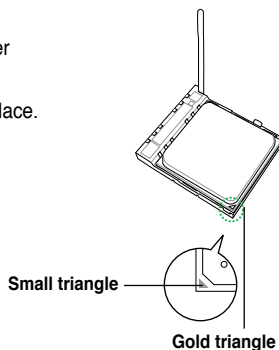

- When the APU is in place, push down the socket lever to secure the APU. The lever clicks on the side tab to indicate that it is locked.
- Install a APU heatsink and fan following the instructions that comes with the heatsink package. You can also refer to section **1.6.2 Installing heatsink and fan** for instructions.

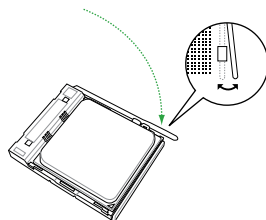

- Connect the CPU fan cable to the CPU_FAN connector on the motherboard.

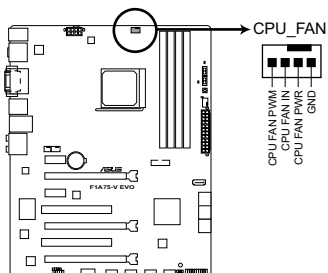

F1A75-V EVO CPU fan connector



DO NOT forget to connect the CPU fan connector! Hardware monitoring errors can occur if you fail to plug this connector.

1.6.2 Installing the heatsink and fan



Ensure that you use only AMD-certified heatsink and fan assembly.

To install the CPU heatsink and fan:

1. Place the heatsink on top of the installed CPU, ensuring that the heatsink fits properly on the retention module base.



- The retention module base is already installed on the motherboard upon purchase.
- You do not have to remove the retention module base when installing the CPU or installing other motherboard components.
- If you purchased a separate CPU heatsink and fan assembly, ensure that a Thermal Interface Material is properly applied to the CPU heatsink or CPU before you install the heatsink and fan assembly.

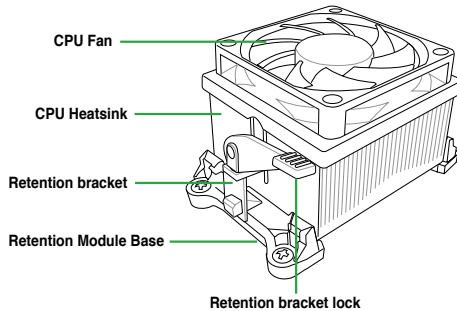

Your boxed CPU heatsink and fan assembly should come with installation instructions for the CPU, heatsink, and the retention mechanism. If the instructions in this section do not match the CPU documentation, follow the latter.

2. Attach one end of the retention bracket to the retention module base.

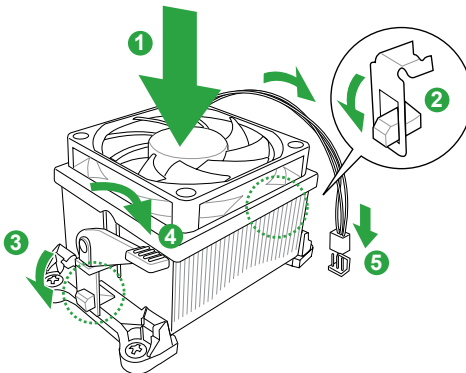

- Align the other end of the retention bracket to the retention module base. A clicking sound denotes that the retention bracket is in place.



Ensure that the fan and heatsink assembly perfectly fits the retention mechanism module base, otherwise you cannot snap the retention bracket in place.

- Push down the retention bracket lock on the retention mechanism to secure the heatsink and fan to the module base.
- When the fan and heatsink assembly is in place, connect the CPU fan cable to the connector on the motherboard labeled CPU_FAN.



DO NOT forget to connect the CPU fan connector! Hardware monitoring errors can occur if you fail to plug this connector.

1.7 System memory

1.7.1 Overview

This motherboard comes with four Double Data Rate 3 (DDR3) Dual Inline Memory Modules (DIMM) sockets. A DDR3 module has the same physical dimensions as a DDR2 DIMM but is notched differently to prevent installation on a DDR2 DIMM socket. DDR3 modules are developed for better performance with less power consumption. The figure illustrates the location of the DDR3 DIMM sockets:

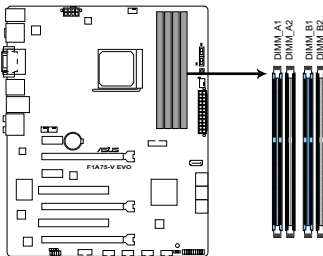

Channel	Sockets
Channel A	DIMM_A1 and DIMM_A2
Channel B	DIMM_B1 and DIMM_B2

F1A75-V EVO 240-pin DDR3 DIMM sockets

1.7.2 Memory configurations

You may install 512MB, 1GB, 2GB, and 4GB unbuffered non-ECC DDR3 DIMMs into the DIMM sockets.



- You may install varying memory sizes in Channel A and Channel B. The system maps the total size of the lower-sized channel for the dual-channel configuration. Any excess memory from the higher-sized channel is then mapped for single-channel operation.
- We recommend that you install the memory modules from the blue slots for better overclocking capability.
- Always install DIMMs with the same CAS latency. For optimum compatibility, we recommend that you obtain memory modules from the same vendor.
- When overclocking, some AMD CPU models may not support DDR3 1866 MHz or higher frequency DIMMs.
- Due to the memory address limitation on 32-bit Windows® OS, when you install 4GB or more memory on the motherboard, the actual usable memory for the OS can be about 3GB or less. For effective use of memory, we recommend that you do any of the following:
 - Install a maximum of 3GB system memory if you are using a 32-bit Windows® OS.
 - Use a 64-bit Windows® OS if you want to install 4GB or more memory on the motherboard.
- This motherboard does not support DIMMs made up of 256 megabits (Mb) chips or less.
- The maximum 64GB memory capacity can be supported with 16GB or above DIMMs. ASUS will update the memory QVL once the DIMMs are available in the market.



- The default memory operation frequency is dependent on its Serial Presence Detect (SPD), which is the standard way of accessing information from a memory module. Under the default state, some memory modules for overclocking may operate at a lower frequency than the vendor-marked value. To operate at the vendor-marked or at a higher frequency, refer to section **2.4 Ai Tweaker menu** for manual memory frequency adjustment.
- For system stability, use a more efficient memory cooling system to support a full memory load (4 DIMMs) or overclocking condition.



Visit the ASUS website at www.asus.com for the latest QVL.

1.7.3 Installing a DIMM



Unplug the power supply before adding or removing DIMMs or other system components. Failure to do so can cause severe damage to both the motherboard and the components.

1. Press the retaining clips outward to unlock a DIMM socket.
2. Align a DIMM on the socket such that the notch on the DIMM matches the DIMM slot key on the socket.

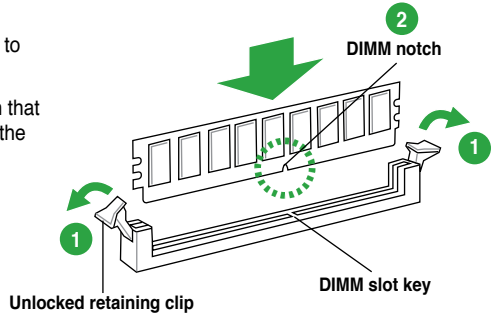

A DIMM is keyed with a notch so that it fits in only one direction. DO NOT force a DIMM into a socket in the wrong direction to avoid damaging the DIMM.

3. Firmly insert the DIMM into the socket until the retaining clips snap back in place and the DIMM is properly seated.

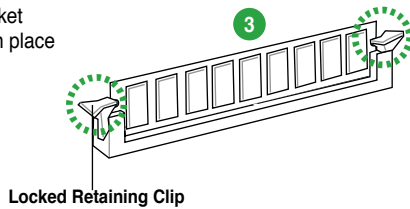

1.7.4 Removing a DIMM

To remove a DIMM:

1. Simultaneously press the retaining clips outward to unlock the DIMM.



Support the DIMM lightly with your fingers when pressing the retaining clips. The DIMM might get damaged when it flips out with extra force.

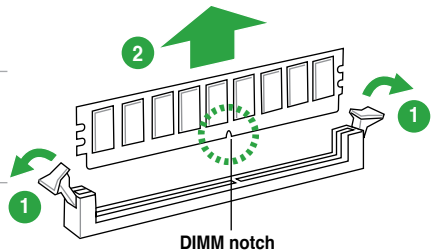

2. Remove the DIMM from the socket.

1.8 Expansion slots

In the future, you may need to install expansion cards. The following sub-sections describe the slots and the expansion cards that they support.



Unplug the power cord before adding or removing expansion cards. Failure to do so may cause you physical injury and damage motherboard components.

1.8.1 Installing an expansion card

To install an expansion card:

1. Before installing the expansion card, read the documentation that came with it and make the necessary hardware settings for the card.
2. Remove the system unit cover (if your motherboard is already installed in a chassis).
3. Remove the bracket opposite the slot that you intend to use. Keep the screw for later use.
4. Align the card connector with the slot and press firmly until the card is completely seated on the slot.
5. Secure the card to the chassis with the screw you removed earlier.
6. Replace the system cover.

1.8.2 Configuring an expansion card

After installing the expansion card, configure it by adjusting the software settings.

1. Turn on the system and change the necessary BIOS settings, if any. See Chapter 2 for information on BIOS setup.
2. Assign an IRQ to the card.
3. Install the software drivers for the expansion card.



When using PCI cards on shared slots, ensure that the drivers support “Share IRQ” or that the cards do not need IRQ assignments. Otherwise, conflicts will arise between the two PCI groups, making the system unstable and the card inoperable.

1.8.3 PCI slots

The PCI slots support cards such as a LAN card, SCSI card, USB card, and other cards that comply with PCI specifications.

1.8.4 PCI Express 2.0 x1 slots

This motherboard supports PCI Express 2.0 x1 network cards, SCSI cards, and other cards that comply with the PCI Express 2.0 specifications.

1.8.5 PCI Express 2.0 x16 slots

This motherboard has three PCI Express 2.0 x16 slots that support PCI Express 2.0 x16 graphic cards complying with the PCI Express specifications.

VGA configuration	PCI Express operating mode		
	PCIe x16_1	PCIe x16_2	PCIe x16_3
Single VGA/PCIe card	x16 (Recommended for single VGA card)	N/A	N/A
Dual VGA/PCIe card	x8	x8	N/A
	x16	N/A	x4



- In single VGA card mode, use the PCIe 2.0 x16_1 slot (blue) for a PCI Express x16 graphics card to get better performance.
- We recommend that you provide sufficient power when running CrossFireX™ mode. See page 1-20 for details.
- Connect a chassis fan to the motherboard connector labeled CHA_FAN1/2 when using multiple graphics cards for better thermal environment.
- In CrossFireX™ mode, use the PCIe 2.0 x16_1 and PCIe 2.0 x16 _2 slots for PCI Express x16 graphics cards to get better performance.
- The PCIe x16_3 slot shares bandwidth with PCIe x1_2 slot. Due to the CrossFireX™ limitation, DO NOT use the PCIe x1_2 slot when you install two CrossFireX™ graphics cards on both the PCIe x16_1 and PCIe x16_3 slots to set up a CrossFireX™ configuration.

1.9 Jumpers

Clear RTC RAM (CLRTC)

This jumper allows you to clear the Real Time Clock (RTC) RAM in CMOS. You can clear the CMOS memory of date, time, and system setup parameters by erasing the CMOS RTC RAM data. The onboard button cell battery powers the RAM data in CMOS, which include system setup information such as system passwords.

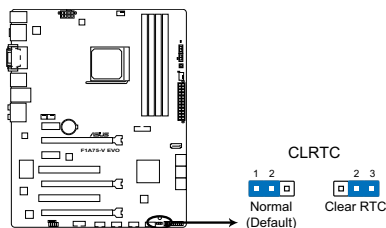

F1A75-V EVO Clear RTC RAM

To erase the RTC RAM:

1. Turn OFF the computer and unplug the power cord.
2. Move the jumper cap from pins 1-2 (default) to pins 2-3. Keep the cap on pins 2-3 for about 5~10 seconds, then move the cap back to pins 1-2.
3. Plug the power cord and turn ON the computer.
4. Hold down the **** key during the boot process and enter BIOS setup to reenter data.



Except when clearing the RTC RAM, never remove the cap on CLRTC jumper default position. Removing the cap will cause system boot failure!



- If the steps above do not help, remove the onboard battery and move the jumper again to clear the CMOS RTC RAM data. After clearing the CMOS, reinstall the battery.
- You do not need to clear the RTC when the system hangs due to overclocking. For system failure due to overclocking, use the CPU Parameter Recall (C.P.R) feature. Shut down and reboot the system so the BIOS can automatically reset parameter settings to default values.

1.10 Connectors

1.10.1 Rear panel ports

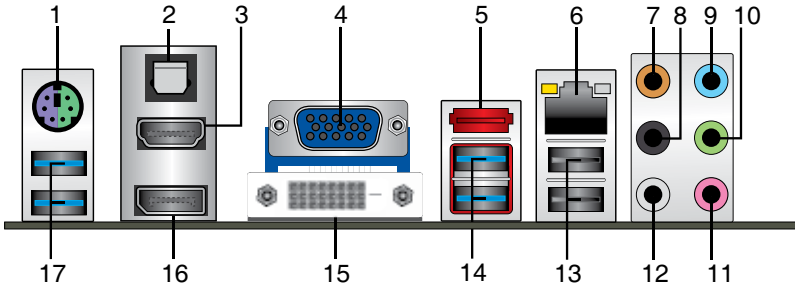

1. **PS/2 Keyboard/Mouse Combo port (purple/green).** This port is for a PS/2 keyboard or PS/2 mouse.
2. **Optical S/PDIF Out port.** This port connects an external audio output device via an optical S/PDIF cable.
3. **HDMI port.** This port is for a High-Definition Multimedia Interface (HDMI) connector, and is HDCP compliant allowing playback of HD DVD, Blu-ray, and other protected content.
4. **Video Graphics Adapter (VGA) port.** This 15-pin port is for a VGA monitor or other VGA-compatible devices.
5. **eSATA 6G port.** This port is for an extra SATA6G device.
6. **LAN (RJ-45) port.** This port allows Gigabit connection to a Local Area Network (LAN) through a network hub.

LAN port LED indications

Activity/Link LED		Speed LED	
Status	Description	Status	Description
OFF	No link	OFF	10Mbps connection
ORANGE	Linked	ORANGE	100Mbps connection
BLINKING	Data activity	GREEN	1Gbps connection

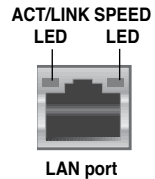

7. **Center/Subwoofer port (orange).** This port connects to the center/subwoofer speakers.
8. **Rear Speaker Out port (black).** This port connects to the rear speakers in the 4, 6, and 8-channel audio configurations.
9. **Line In port (light blue).** This port connects to the tape, CD, DVD player, or other audio sources.
10. **Line Out port (lime).** This port connects to a headphone or a speaker. In the 4, 6 and 8-channel configurations, the function of this port becomes Front Speaker Out.
11. **Microphone port (pink).** This port connects to a microphone.
12. **Side Speaker Out port (gray).** This port connects to the side speakers in the 8-channel audio configuration.



Refer to the audio configuration table below for the function of the audio ports in the 2, 4, 6, or 8-channel configuration.

Audio 2, 4, 6, or 8-channel configuration

Port	Headset 2-channel	4-channel	6-channel	8-channel
Light Blue	Line In	Line In	Line In	Line In
Lime	Line Out	Front Speaker Out	Front Speaker Out	Front Speaker Out
Pink	Mic In	Mic In	Mic In	Mic In
Orange	–	–	Center/Subwoofer	Center/Subwoofer
Black	–	Rear Speaker Out	Rear Speaker Out	Rear Speaker Out
Gray	–	–	–	Side Speaker Out

13. **USB 2.0 ports 1 and 2.** These two 4-pin Universal Serial Bus (USB) ports are for USB 2.0/1.1 devices.
14. **USB 3.0 ports 1 and 2.** These two 9-pin Universal Serial Bus (USB) ports are for USB 3.0 devices.
15. **DVI-D port.** This port is for any DVI-D compatible device. DVI-D can't be converted to output RGB Signal to CRT and isn't compatible with DVI-I.
16. **DisplayPort.** This port is for a DisplayPort-compatible devices.
17. **USB 3.0 ports 3 and 4.** These two 9-pin Universal Serial Bus (USB) ports are for USB 3.0 devices.



- DO NOT connect a keyboard / mouse to any USB 3.0 port when installing Windows® operating system.
- Due to USB 3.0 controller limitation, USB 3.0 devices can only be used under Windows® OS environment and after the USB 3.0 driver installation.
- USB 3.0 devices can only be used as data storage only.
- We strongly recommend that you connect USB 3.0 devices to USB 3.0 ports for faster and better performance for your USB 3.0 devices.

Dual display table

This table indicates whether the dual display you want to use is supported or not.



Dual display output	Supported	Not supported
DVI + D-Sub	•	
HDMI + D-Sub	•	
DVI + HDMI		•
DVI + DisplayPort	•	
D-Sub + DisplayPort	•	
HDMI + DisplayPort	•	

1.10.2 Internal connectors

1. Power, CPU and chassis fan connectors (3-pin PWR_FAN, 4-pin CPU_FAN, and 4-pin CHA_FAN1/2)

Connect the fan cables to the fan connectors on the motherboard, ensuring that the black wire of each cable matches the ground pin of the connector.

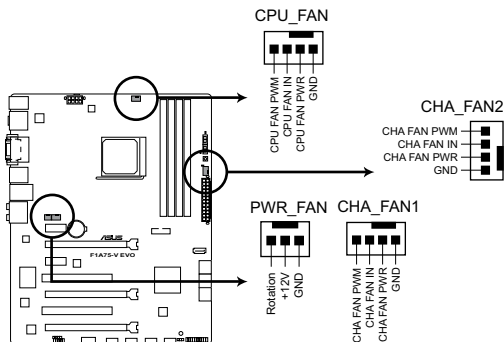

F1A75-V EVO fan connectors



DO NOT forget to connect the fan cables to the fan connectors. Insufficient air flow inside the system may damage the motherboard components. These are not jumpers! DO NOT place jumper caps on the fan connectors.



- The CPU_FAN connector supports a CPU fan of maximum 2A (24 W) fan power.
- Only the CPU_FAN and CHA_FAN1/2 connectors support the ASUS Fan Xpert feature.
- If you install two VGA cards, we recommend that you plug the rear chassis fan cable to the motherboard connector labeled CHA_FAN1/2 for better thermal environment.

2. ATX power connectors (24-pin EATXPWR, 8-pin EATX12V)

These connectors are for an ATX power supply. The plugs from the power supply are designed to fit these connectors in only one orientation. Find the proper orientation and push down firmly until the connectors completely fit.

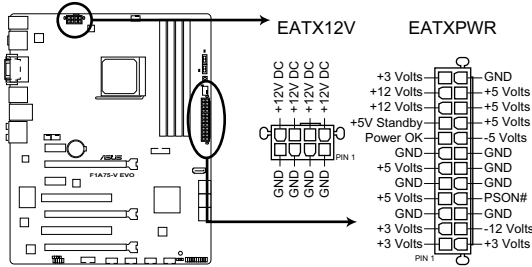

F1A75-V EVO ATX power connectors



- We recommend that you use an ATX 12V Specification 2.0-compliant power supply unit (PSU) with a minimum of 300W power rating. This PSU type has 24-pin and 4-pin power plugs.
- If you intend to use a PSU with 20-pin and 4-pin power plugs, ensure that the 20-pin power plug can provide at least 15 A on +12 V and that the PSU has a minimum power rating of 300W. The system may become unstable or may not boot up if the power is inadequate.
- DO NOT forget to connect the 4-pin / 8-pin ATX +12V power plug. Otherwise, the system will not boot up.
- We recommend that you use a PSU with higher power output when configuring a system with more power-consuming devices or when you intend to install additional devices. The system may become unstable or may not boot up if the power is inadequate.
- If you are uncertain about the minimum power supply requirement for your system, refer to the Recommended Power Supply Wattage Calculator at <http://support.asus.com/PowerSupplyCalculator/PSCalculator.aspx?SLanguage=en-us> for details.

3. Serial ATA 6.0 Gb/s connectors (7-pin SATA6G_E1, SATA6G_1~6)

These connectors are for the Serial ATA 6.0 Gb/s signal cables for Serial ATA hard disk drives and optical disc drives. If you installed Serial ATA hard disk drives, you can create a RAID 0, RAID 1, RAID 10 or JBOD configuration through the onboard AMD® A75 FCH controller.

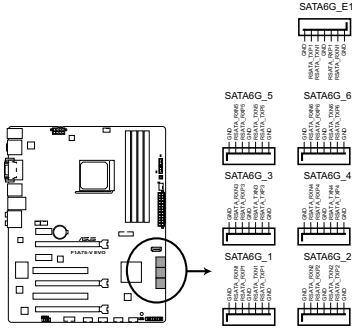

F1A75-V EVO SATA 6.0Gb/s connectors



- These connectors are set to **IDE** mode by default. In IDE mode, you can connect Serial ATA boot/data hard disk drives to these connectors. If you intend to create a Serial ATA RAID set using these disk connectors, set the type of the SATA connectors in the BIOS to **[RAID]**. See section 2.5.2 **SATA Configuration** for details.
- You must install Windows® XP Service Pack 3 or later version before using Serial ATA hard disk drives. The Serial ATA RAID feature is available only if you are using Windows® XP SP3 or later version.
- When using hot-plug and NCQ, set the type of the SATA connectors in the BIOS to **[AHCI]**. See section 2.5.2 **SATA Configuration** for details.

4. Serial port connector (10-1 pin COM1)

This connector is for a serial (COM) port. Connect the serial port module cable to this connector, then install the module to a slot opening at the back of the system chassis.

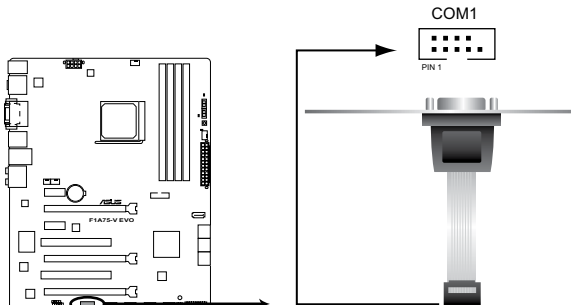

F1A75-V EVO Serial port (COM1) connector



The COM module is purchased separately.

5. System panel connector (20-8 pin PANEL)

This connector supports several chassis-mounted functions.

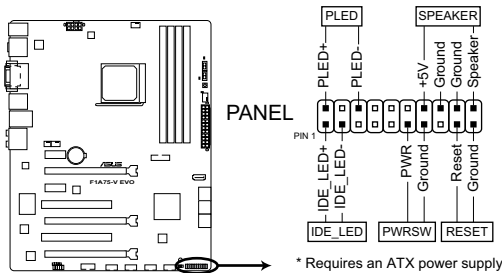

F1A75-V EVO System panel connector

- **System power LED (2-pin PLED)**

This 2-pin connector is for the system power LED. Connect the chassis power LED cable to this connector. The system power LED lights up when you turn on the system power, and blinks when the system is in sleep mode.

- **Hard disk drive activity LED (2-pin IDE_LED)**

This 2-pin connector is for the HDD Activity LED. Connect the HDD Activity LED cable to this connector. The IDE LED lights up or flashes when data is read from or written to the HDD.

- **System warning speaker (4-pin SPEAKER)**

This 4-pin connector is for the chassis-mounted system warning speaker. The speaker allows you to hear system beeps and warnings.

- **ATX power button/soft-off button (2-pin PWRSW)**

This connector is for the system power button.

- **Reset button (2-pin RESET)**

This 2-pin connector is for the chassis-mounted reset button for system reboot without turning off the system power.

6. Digital audio connector (4-1 pin SPDIF_OUT)

This connector is for an additional Sony/Philips Digital Interface (S/PDIF) port.

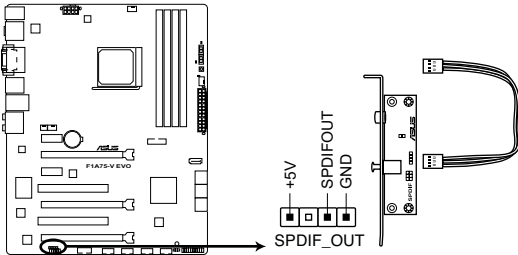

F1A75-V EVO Digital audio connector



Ensure that the audio device of Sound playback is **Realtek High Definition Audio** (the name may be different based on the OS). Go to **Start > Control Panel > Sounds and Audio Devices > Sound Playback** to configure the setting.



The S/PDIF module is purchased separately.

7. Front panel audio connector (10-1 pin AAFP)

This connector is for a chassis-mounted front panel audio I/O module that supports either High Definition Audio or AC'97 audio standard. Connect one end of the front panel audio I/O module cable to this connector.

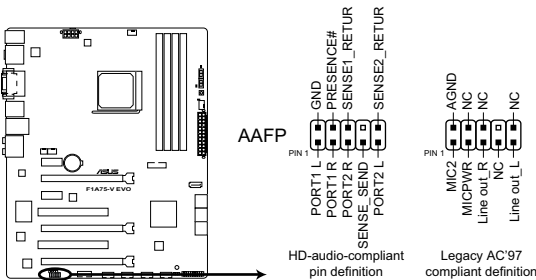

F1A75-V EVO Front panel audio connector



- We recommend that you connect a high-definition front panel audio module to this connector to avail of the motherboard high-definition audio capability.
- If you want to connect a high definition front panel audio module to this connector, set the **Front Panel Type** item in the BIOS to **[HD]**. See section **2.5.5 Onboard Devices Configuration** for details.
- The front panel audio I/O module is purchased separately.

8. USB 2.0 connectors (10-1 pin USB34, USB56, USB78, USB910)

These connectors are for USB 2.0 ports. Connect the USB module cable to any of these connectors, then install the module to a slot opening at the back of the system chassis. These USB connectors comply with USB 2.0 specification that supports up to 480Mbps connection speed.

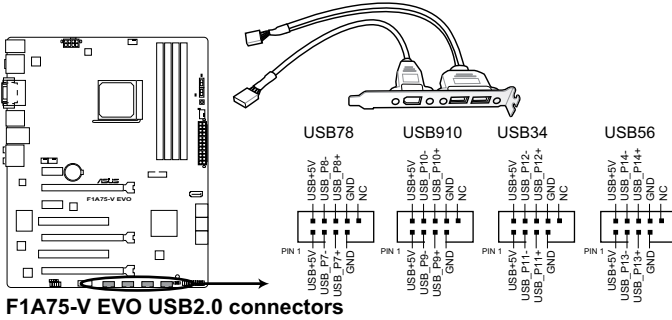

Never connect a 1394 cable to the USB connectors. Doing so will damage the motherboard!



The USB 2.0 module is purchased separately.

9. USB 3.0 connector (20-1 pin USB3_56)

This connector is for the additional USB 3.0 ports. Connect the USB 3.0 bracket cable to this connector, then install the USB 3.0 bracket to the rear side of the chassis. If your chassis support customized front panel installation, with ASUS USB 3.0 header, you can have a front panel USB 3.0 solution.

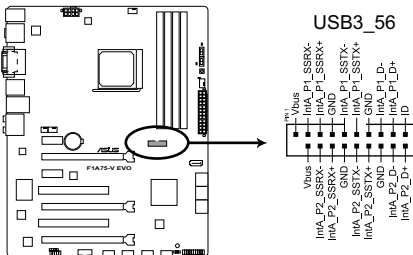

The USB 3.0 module is purchased separately.

1.11 Onboard switch

Onboard switches allow you to fine-tune performance when working on a bare or open-case system. This is ideal for overclockers and gamers who continually change settings to enhance system performance.

1. MemOK! switch

Installing DIMMs that are incompatible with the motherboard may cause system boot failure, and the DRAM_LED near the MemOK! switch lights continuously. Press and hold the MemOK! switch until the DRAM_LED starts blinking to begin automatic memory compatibility tuning for successful boot.

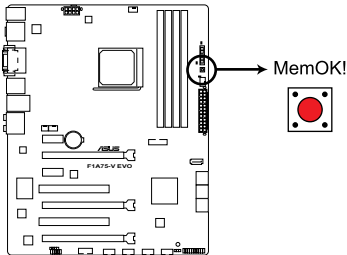

F1A75-V EVO MemOK! switch



- Refer to section **1.12 Onboard LEDs** for the exact location of the DRAM_LED.
- The DRAM_LED also lights when the DIMM is not properly installed. Turn off the system and reinstall the DIMM before using the MemOK! function.
- The MemOK! switch does not function under Windows® OS environment.
- During the tuning process, the system loads and tests failsafe memory settings. It takes about 30 seconds for the system to test one set of failsafe settings. If the test fails, the system reboots and test the next set of failsafe settings. The blinking speed of the DRAM_LED increases, indicating different test processes.
- Due to memory tuning requirement, the system automatically reboots when each timing set is tested. If the installed DIMMs still fail to boot after the whole tuning process, the DRAM_LED lights continuously. Replace the DIMMs with ones recommended in the Memory QVL (Qualified Vendors Lists) in this user manual or on the ASUS website at www.asus.com.
- If you turn off the computer and replace DIMMs during the tuning process, the system continues memory tuning after turning on the computer. To stop memory tuning, turn off the computer and unplug the power cord for about 5–10 seconds.
- If your system fail to boot due to BIOS overclocking, press the MemOK! switch to boot and load BIOS default settings. A message will appear during POST reminding you that the BIOS has been restored to its default settings.
- We recommend that you download and update to the latest BIOS version from the ASUS website at www.asus.com after using the MemOK! function.

2. TPU switch

This switch allows you to enable or disable the TPU function.

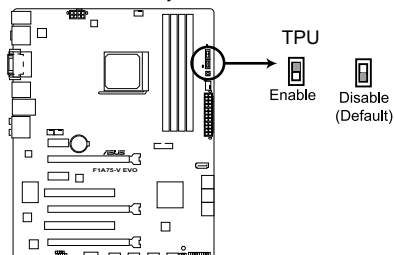

F1A75-V EVO TPU switch



- The TPU LED (ELED730) near the TPU switch lights when the switch setting is turned to **Enable**.
- If you clear the CMOS or load the BIOS setup defaults, the related overclocking items in the BIOS menu follow the current setting of the TPU switch.
- If you change the switch setting to **Enable** under the OS environment, the TPU function will be activated after the next system bootup.
- You may use the TurboV and Auto Tuning features in the TurboV EVO application, adjust the BIOS settings, or enable the TPU function at the same time. However, the system will use the last setting you have made.

3. EPU switch

This switch allows you to enable or disable the EPU function.

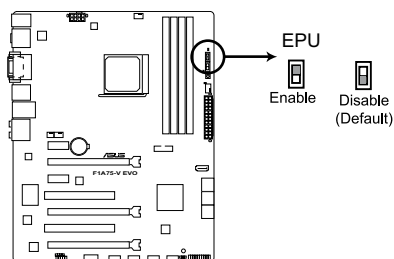

F1A75-V EVO EPU switch



- The EPU LED (ELED740) near the TPU switch lights when the switch setting is turned to **Enable**.
- If you change the switch setting to **Enable** under the OS environment, the EPU function will be activated after the next system bootup.
- You may change the EPU settings in the EPU application, change the BIOS settings, and enable the EPU function at the same time. However, the system will use the last setting you have made.

1.12 Onboard LEDs

1. Standby Power LED

The motherboard comes with a standby power LED that lights up to indicate that the system is ON, in sleep mode, or in soft-off mode. This is a reminder that you should shut down the system and unplug the power cable before removing or plugging in any motherboard component. The illustration below shows the location of the onboard LED.

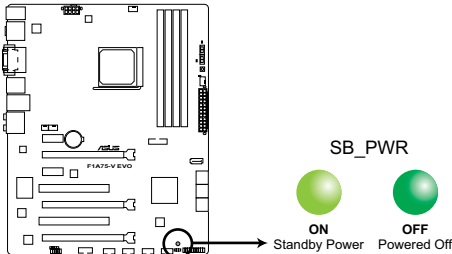

F1A75-V EVO Onboard LED

2. DRAM LED

DRAM LED checks the DRAM in sequence during motherboard booting process. If an error is found, the LED next to the error device will continue lighting until the problem is solved. This user-friendly design provides an intuitive way to locate the root problem within a second.

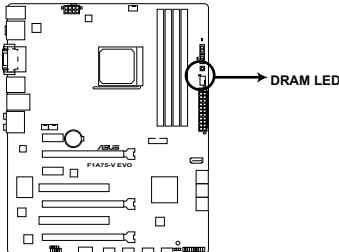

F1A75-V EVO DRAM LED

3. TPU LED

The TPU LED lights when the TPU switch is turned to **Enable**.

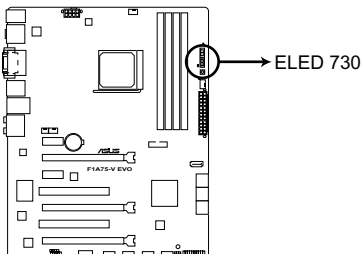

F1A75-V EVO TPU LED

4. EPU LED

The EPU LED lights when the EPU switch is turned to **Enable**.

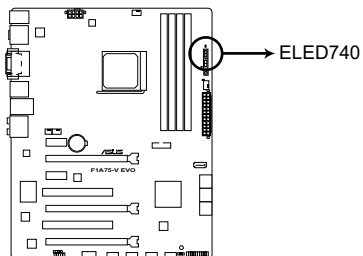

F1A75-V EVO EPU LED

1.13 Software support

1.13.1 Installing an operating system

This motherboard supports Windows® XP / Vista / 7 Operating Systems (OS). Always install the latest OS version and corresponding updates to maximize the features of your hardware.



- Motherboard settings and hardware options vary. Refer to your OS documentation for detailed information.
- Ensure that you install Windows® XP Service Pack 3 or later versions / Windows® Vista Service Pack 1 or later versions before installing the drivers for better compatibility and system stability.

1.13.2 Support DVD information

The Support DVD that comes with the motherboard package contains the drivers, software applications, and utilities that you can install to avail all motherboard features.



The contents of the Support DVD are subject to change at any time without notice. Visit the ASUS website at www.asus.com for updates.

To run the Support DVD

Place the Support DVD into the optical drive. If Autorun is enabled in your computer, the DVD automatically displays the Specials screen. Click Drivers, Utilities, Make Disk, Manual, and Contact tabs to display their respective menus.



The following screen is for reference only.



Click an icon to display Support DVD/motherboard information

Click an item to install



If Autorun is NOT enabled on your computer, browse the contents of the Support DVD to locate the file ASSETUP.EXE from the BIN folder. Double-click the ASSETUP.EXE to run the DVD.

Chapter 2

BIOS information

2.1 Managing and updating your BIOS



Save a copy of the original motherboard BIOS file to a USB flash disk in case you need to restore the BIOS in the future. Copy the original motherboard BIOS using the ASUS Update utility.

2.1.1 ASUS Update utility

The ASUS Update is a utility that allows you to manage, save, and update the motherboard BIOS in Windows® environment.



- ASUS Update requires an Internet connection either through a network or an Internet Service Provider (ISP).
 - This utility is available in the support DVD that comes with the motherboard package.
-

Installing ASUS Update

To install ASUS Update:

1. Place the support DVD in the optical drive. The **Drivers** menu appears.
2. Click the **Utilities** tab, then click **AI Suite II**.
3. Follow the onscreen instructions to complete the installation.



Quit all Windows® applications before you update the BIOS using this utility.

Updating the BIOS

To update the BIOS:

1. From the Windows® desktop, click **Start > Programs > ASUS > AI Suite II > AI Suite II X.XX.XX** to launch the AI Suite II utility. The AI Suite II Quick Bar appears.
2. Click **Update** button from the Quick Bar, and then click **ASUS Update** from the popup menu. The **ASUS Update** main screen appears. From the list, select either of the following methods:

Updating from the Internet

- a. Select **Update BIOS from the Internet**, then click **Next**.
- b. Select the ASUS FTP site nearest you to avoid network traffic, then click **Next**.
- c. From the FTP site, select the BIOS version that you wish to download then click **Next**.



The ASUS Update utility is capable of updating itself through the Internet. Always update the utility to avail all its features.

Updating from a BIOS file

- a. Select **Update BIOS from file**, then click **Next**.
 - b. Locate the BIOS file from the **Open** window, then click **Open**.
3. Follow the onscreen instructions to complete the updating process.

2.1.2 ASUS EZ Flash 2

The ASUS EZ Flash 2 feature allows you to update the BIOS without using an OS-based utility.



Before you start using this utility, download the latest BIOS file from the ASUS website at www.asus.com.

To update the BIOS using EZ Flash 2:

1. Insert the USB flash disk that contains the latest BIOS file to the USB port.
2. Enter the Advanced Mode of the BIOS setup program. Go to the **Tool** menu to select **ASUS EZ Flash Utility** and press **<Enter>** to enable it.

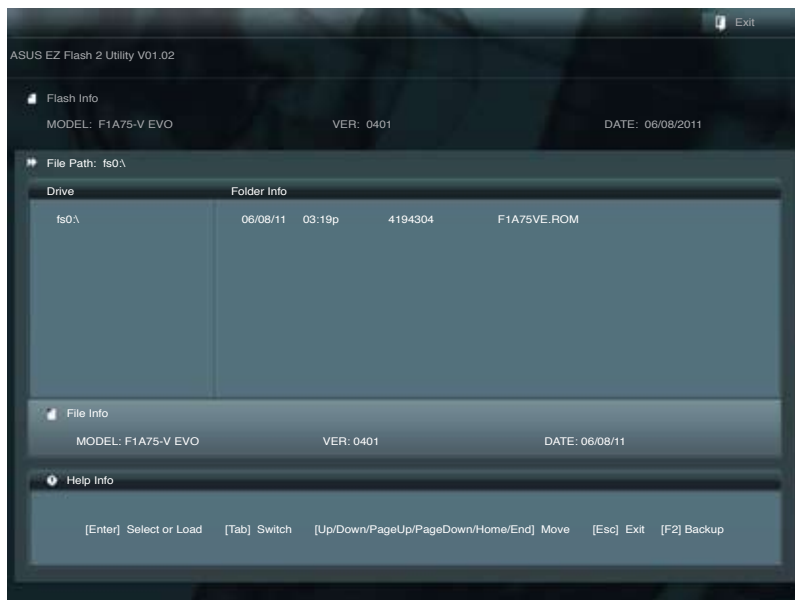

3. Press **<Tab>** to switch to the **Drive** field.
4. Press the Up/Down arrow keys to find the USB flash disk that contains the latest BIOS, and then press **<Enter>**.
5. Press **<Tab>** to switch to the **Folder Info** field.
6. Press the Up/Down arrow keys to find the BIOS file, and then press **<Enter>** to perform the BIOS update process. Reboot the system when the update process is done.



-
- This function supports USB flash disks with **FAT 32/16** format and single partition only.
 - **DO NOT** shut down or reset the system while updating the BIOS to prevent system boot failure!
-

2.1.3 ASUS CrashFree BIOS 3 utility

The ASUS CrashFree BIOS 3 is an auto recovery tool that allows you to restore the BIOS file when it fails or gets corrupted during the updating process. You can restore a corrupted BIOS file using the motherboard support DVD or a USB flash drive that contains the updated BIOS file.



-
- Before using this utility, rename the BIOS file in the removable device into **F1A75VE.ROM**.
 - The BIOS file in the support DVD may not be the latest version. Download the latest BIOS file from the ASUS website at www.asus.com.
-

Recovering the BIOS

To recover the BIOS:

1. Turn on the system.
2. Insert the support DVD to the optical drive or the USB flash drive that contains the BIOS file to the USB port.
3. The utility automatically checks the devices for the BIOS file. When found, the utility reads the BIOS file and enters ASUS EZ Flash 2 utility automatically.
4. The system requires you to enter BIOS Setup to recover BIOS setting. To ensure system compatibility and stability, we recommend that you press **<F5>** to load default BIOS values.



DO NOT shut down or reset the system while updating the BIOS! Doing so can cause system boot failure!

2.1.4 ASUS BIOS Updater

The ASUS BIOS Updater allows you to update BIOS in DOS environment. This utility also allows you to copy the current BIOS file that you can use as a backup when the BIOS fails or gets corrupted during the updating process.



The succeeding utility screens are for reference only. The actual utility screen displays may not be same as shown.

Before updating BIOS

1. Prepare the motherboard support DVD and a USB flash drive in FAT32/16 format and single partition.
2. Download the latest BIOS file and BIOS Updater from the ASUS website at <http://support.asus.com> and save them on the USB flash drive.



NTFS is not supported under DOS environment. Do not save the BIOS file and BIOS Updater to a hard disk drive or USB flash drive in NTFS format.

3. Turn off the computer and disconnect all SATA hard disk drives (optional).

Booting the system in DOS environment

1. Insert the USB flash drive with the latest BIOS file and BIOS Updater to the USB port.
2. Boot your computer. When the ASUS Logo appears, press <F8> to show the **BIOS Boot Device Select Menu**. Insert the support DVD into the optical drive and select the optical drive as the boot device.

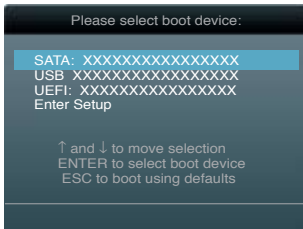

3. When the **Make Disk** menu appears, select the **FreeDOS command prompt** item by pressing the item number.
4. At the FreeDOS prompt, type **d:** and press <Enter> to switch the disk from Drive C (optical drive) to Drive D (USB flash drive).

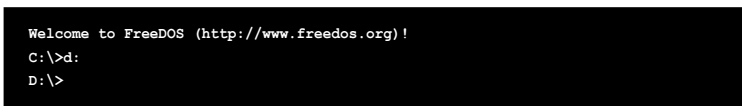

Backing up the current BIOS

To backup the current BIOS file using the BIOS Updater



Ensure that the USB flash drive is not write-protected and has enough free space to save the file.

1. At the FreeDOS prompt, type `bupdater /o [filename]` and press <Enter>.

```
D:\>bupdater /oOLDBIOS1_rom
```

Filename Extension

The [filename] is any user-assigned filename with no more than eight alphanumeric characters for the filename and three alphanumeric characters for the extension.

2. The BIOS Updater backup screen appears indicating the BIOS backup process. When BIOS backup is done, press any key to return to the DOS prompt.

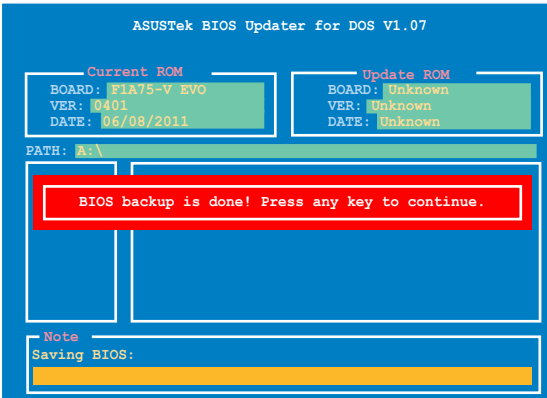

Updating the BIOS file

To update the BIOS file using BIOS Updater

1. At the FreeDOS prompt, type `bupdater /pc /g` and press <Enter>.

```
D:\>bupdater /pc /g
```

2. The BIOS Updater screen appears as below.

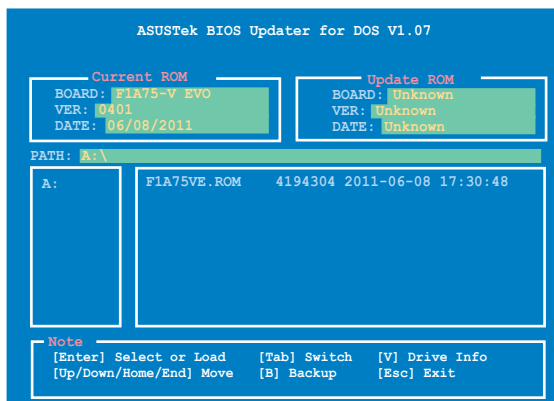

3. Press <Tab> to switch between screen fields and use the <Up/Down/Home/End> keys to select the BIOS file and press <Enter>. BIOS Updater checks the selected BIOS file and prompts you to confirm BIOS update.



4. Select Yes and press <Enter>. When BIOS update is done, press <ESC> to exit BIOS Updater. Restart your computer.



DO NOT shut down or reset the system while updating the BIOS to prevent system boot failure!



- For BIOS Updater version 1.04 or later, the utility automatically exits to the DOS prompt after updating BIOS.
- Ensure to load the BIOS default settings to ensure system compatibility and stability. Select the **Load Optimized Defaults** item under the Exit menu. Refer to section 2.9 **Exit menu** for details.
- Ensure to connect all SATA hard disk drives after updating the BIOS file if you have disconnected them.

2.2 BIOS setup program

Use the BIOS Setup program to update the BIOS or configure its parameters. The BIOS screens include navigation keys and brief online help to guide you in using the BIOS Setup program.

Entering BIOS Setup at startup

To enter BIOS Setup at startup:

- Press <Delete> during the Power-On Self Test (POST). If you do not press <Delete>, POST continues with its routines.

Entering BIOS Setup after POST

To enter BIOS Setup after POST:

- Press <Ctrl>+<Alt>+ simultaneously.
- Press the reset button on the system chassis.
- Press the power button to turn the system off then back on. Do this option only if you failed to enter BIOS Setup using the first two options.



Using the **power button**, **reset button**, or the <Ctrl>+<Alt>+ keys to force reset from a running operating system can cause damage to your data or system. We recommend to always shut down the system properly from the operating system.



-
- The BIOS setup screens shown in this section are for reference purposes only, and may not exactly match what you see on your screen.
 - Ensure that a USB mouse is connected to your motherboard if you want to use the mouse to control the BIOS setup program.
 - The default BIOS settings for this motherboard apply for most conditions to ensure optimum performance. If the system becomes unstable after changing any BIOS settings, load the default settings to ensure system compatibility and stability. Select the **Load Optimized Defaults** item under the Exit Menu. See section **2.9 Exit Menu**.
 - If the system fails to boot after changing any BIOS setting, try to clear the CMOS and reset the motherboard to the default value. Refer to section **1.9 Jumpers** on how to erase the RTC RAM.
 - The BIOS setup program does not support the bluetooth devices.
-

BIOS menu screen

The BIOS setup program can be used under two modes: EZ Mode and Advanced Mode. You can change modes from the Exit menu or from the Exit/Advanced Mode button in the EZ Mode/Advanced Mode screen.

EZ Mode

By default, the EZ Mode screen appears when you enter the BIOS setup program. The EZ Mode provides you an overview of the basic system information, and allows you to select the display language, system performance mode and boot device priority. To access the Advanced Mode, click Exit/Advanced Mode, then select Advanced Mode.



The default screen for entering the BIOS setup program can be changed. Refer to the **Setup Mode** item in section 2.7 **Boot menu** for details.

The screenshot shows the ASUS EFI BIOS Utility - EZ Mode interface. Key elements include:

- System Information:** F1A75-V EVO, BIOS Version: 0401, Build Date: 06/08/2011, CPU Type: AMD Engineering Sample, Speed: 2400 MHz, Total Memory: 1024 MB (DDR3 1066MHz).
- Temperature:** CPU +113.0°F/+45.0°C, MB +75.2°F/+40.0°C.
- Voltage:** 1.248V, 5V, 5.160V, 3.3V, 3.344V, 12V, 12.248V.
- Fan Speed:** CPU_FAN 3325RPM, PWR_FAN N/A, CHA_FAN 3325RPM, CHA_FAN2 N/A.
- Q-Fan Control:** Modes include Quiet, Performance, Energy Saving, Normal, and an ASUS Optimal mode.
- Boot Priority:** Shows options for booting from a hard drive or CD/DVD.
- Navigation:** Buttons for Boot Menu(F8) and Default(F5).

Annotations on the screenshot:

- Exit/Advanced Mode:** Clicks to display all fan speeds if available.
- Language:** Selects the display language of the BIOS setup program.
- Temperature/Voltage/Fan Speed:** Displays the CPU/motherboard temperature, CPU/5V/3.3V/12V voltage output, CPU/chassis/power fan speed.
- Q-Fan Control:** Exits the BIOS setup program without saving the changes, saves the changes and resets the system, or enters the Advanced Mode.
- Boot Priority:** Selects the boot device priority.
- Q-Fan Control Modes:**
 - Energy Saving:** Power Saving mode.
 - Normal:** Normal mode.
 - ASUS Optimal mode:** Loads optimized default.
- Boot Priority:** Displays the system properties of the selected mode on the right hand side.
- Default(F5):** Loads optimized default.
- Boot Menu(F8):** Selects the boot device priority.



- The boot device options vary depending on the devices you installed to the system.
- The **Boot Menu(F8)** button is available only when the boot device is installed to the system.

Advanced Mode

The Advanced Mode provides advanced options for experienced end-users to configure the BIOS settings. The figure below shows an example of the Advanced Mode. Refer to the following sections for the detailed configurations.



To access the EZ Mode, click **Exit**, then select **ASUS EZ Mode**.



Menu bar

The menu bar on top of the screen has the following main items:

Main	For changing the basic system configuration
Ai Tweaker	For changing the overclocking settings
Advanced	For changing the advanced system settings
Monitor	For displaying the system temperature, power status, and changing the fan settings
Boot	For changing the system boot configuration
Tool	For configuring options for special functions
Exit	For selecting the exit options and loading default settings

Menu items

The highlighted item on the menu bar displays the specific items for that menu. For example, selecting **Main** shows the Main menu items.

The other items (Ai Tweaker, Advanced, Monitor, Boot, Tool, and Exit) on the menu bar have their respective menu items.

Back button

This button appears when entering a submenu. Press <Esc> or use the USB mouse to click this button to return to the previous menu screen.

Submenu items

A greater than sign (>) before each item on any menu screen means that the item has a submenu. To display the submenu, select the item and press <Enter> or double-click the item.

Pop-up window

Select a menu item and press <Enter> to display a pop-up window with the configuration options for that item.

Scroll bar

A scroll bar appears on the right side of a menu screen when there are items that do not fit on the screen. Press the Up/Down arrow keys or <Page Up> / <Page Down> keys to display the other items on the screen.

Navigation keys

At the bottom right corner of the menu screen are the navigation keys for the BIOS setup program. Use the navigation keys to select items in the menu and change the settings.

General help

At the top right corner of the menu screen is a brief description of the selected item.

Configuration fields

These fields show the values for the menu items. If an item is user-configurable, you can change the value of the field opposite the item. You cannot select an item that is not user-configurable.

A configurable field is highlighted when selected. To change the value of a field, select it and press <Enter> or click on it to display a list of options.

2.3 Main menu

The Main menu screen appears when you enter the Advanced Mode of the BIOS Setup program. The Main menu provides you an overview of the basic system information, and allows you to set the system date, time, language, and security settings.

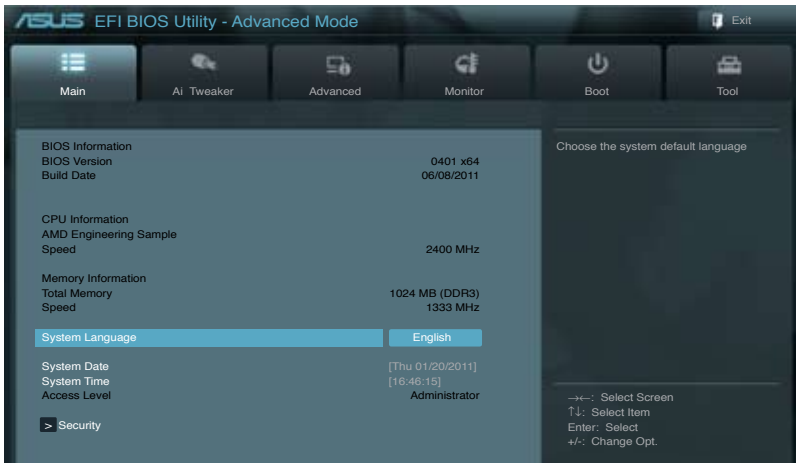

2.3.1 System Language [English]

Allows you to choose the BIOS language version from the options. Configuration options: [English] [Français] [Deutsch] [简体中文] [繁體中文] [日本語]

2.3.2 System Date [Day xx/xx/xxxx]

Allows you to set the system date.

2.3.3 System Time [xx:xx:xx]

Allows you to set the system time.

2.3.4 Security

The Security menu items allow you to change the system security settings.



- If you have forgotten your BIOS password, erase the CMOS Real Time Clock (RTC) RAM to clear the BIOS password. See section 1.9 **Jumpers** for information on how to erase the RTC RAM.
- The **Administrator** or **User Password** items on top of the screen show the default **Not Installed**. After you set a password, these items show **Installed**.

Administrator Password

If you have set an administrator password, we recommend that you enter the administrator password for accessing the system. Otherwise, you might be able to see or change only selected fields in the BIOS setup program.

To set an administrator password:

1. Select the **Administrator Password** item and press <Enter>.
2. From the **Create New Password** box, key in a password, then press <Enter>.
3. Confirm the password when prompted.

To change an administrator password:

1. Select the **Administrator Password** item and press <Enter>.
2. From the **Enter Current Password** box, key in the current password, then press <Enter>.
3. From the **Create New Password** box, key in a new password, then press <Enter>.
4. Confirm the password when prompted.

To clear the administrator password, follow the same steps as in changing an administrator password, but press <Enter> when prompted to create/confirm the password. After you clear the password, the **Administrator Password** item on top of the screen shows **Not Installed**.

User Password

If you have set a user password, you must enter the user password for accessing the system. The **User Password** item on top of the screen shows the default **Not Installed**. After you set a password, this item shows **Installed**.

To set a user password:

1. Select the **User Password** item and press <Enter>.
2. From the **Create New Password** box, key in a password, then press <Enter>.
3. Confirm the password when prompted.

To change a user password:

1. Select the **User Password** item and press <Enter>.
2. From the **Enter Current Password** box, key in the current password, then press <Enter>.
3. From the **Create New Password** box, key in a new password, then press <Enter>.
4. Confirm the password when prompted.

To clear the user password, follow the same steps as in changing a user password, but press <Enter> when prompted to create/confirm the password. After you clear the password, the **User Password** item on top of the screen shows **Not Installed**.

2.4 Ai Tweaker menu

The Ai Tweaker menu items allow you to configure overclocking-related items.



Be cautious when changing the settings of the Ai Tweaker menu items. Incorrect field values can cause the system to malfunction.



The configuration options for this section vary depending on the CPU and DIMM model you installed on the motherboard.

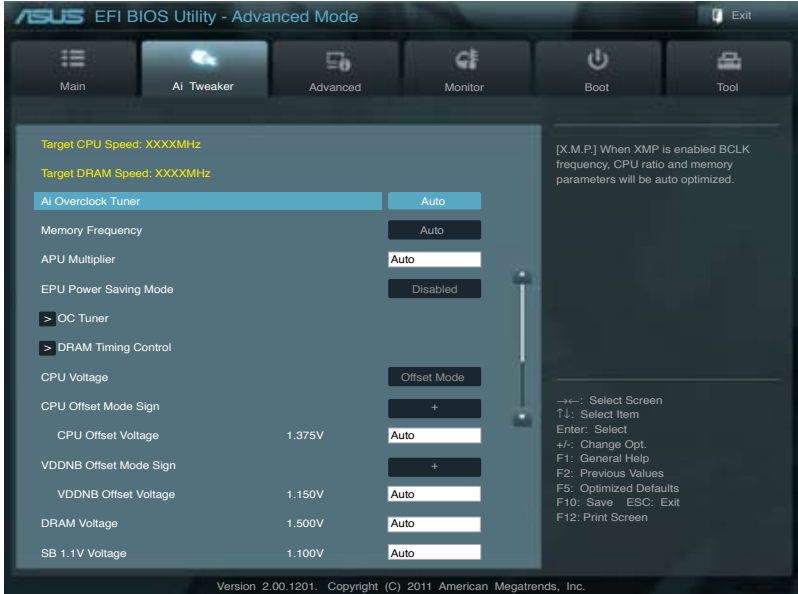

Scroll down to display the following items:



Target CPU Speed : xxxxMHz

Displays the current CPU speed.

Target DRAM Speed : xxxxMHz

Displays the current DRAM speed.

2.4.1 Ai Overclock Tuner [Auto]

Allows you to select the CPU overclocking options to achieve the desired CPU internal frequency. Select any of these preset overclocking configuration options:

- [Auto] Loads the optimal settings for the system.
- [Manual] Allows you to individually set overclocking parameters.
- [D.O.C.P.] Allows you to select a DRAM O.C. profile, and the related parameters will be adjusted automatically.

APU Frequency [XXX]

This item appears only when you set the **Ai Overclock Tuner** item to [Manual]. Use the <+> and <-> keys to adjust the value. You can also key in the desired value using the numeric keypad. The values range from 90.0MHz to 300.0MHz.

DRAM O.C. Profile [DDR3-1600MHz 9-9-9-24 1.65V]

This item appears only when you set the **Ai Overclock Tuner** item to [D.O.C.P.], and allows you to select a DRAM O.C. profile, which applies different settings to DRAM frequency, DRAM timing and DRAM voltage. Configuration options: [DDR3-1600MHz 9-9-9-24 1.65V] [DDR3-1800MHz 9-9-9-24 1.65V] [DDR3-1866MHz 9-9-9-24 1.65V] [DDR3-2000MHz 9-9-9-24 1.65V] [DDR3-2133MHz 9-9-9-24 1.65V] [DDR3-2200MHz 9-9-9-24 1.65V] [DDR3-2400MHz 9-9-9-24 1.65V]

2.4.2 Memory Frequency [Auto]

Allows you to set the memory operating frequency. Configuration options: [Auto] [DDR3-800MHz] [DDR3-1066MHz] [DDR3-1333MHz] [DDR3-1600MHz] [DDR3-1866MHz]



Selecting a very high memory frequency may cause the system to become unstable! If this happens, revert to the default setting.

2.4.3 APU Multiplier [Auto]

Allows you to set the multiplier between the CPU Core Clock and the FSB Frequency. Use the <+> and <-> keys to adjust the ratio. The valid value ranges vary according to your CPU model.

2.4.4 EPU Power Saving Mode [Disabled]

Allows you to enable or disable the EPU power saving function. Configuration options: [Disabled] [Enabled]

EPU Setting [Auto]

This item appears only when The EPU Power Saving Mode is set to [Enabled] and allows you to set power saving mode. Configuration options: [Auto] [Light Power Saving Mode] [Medium Power Saving Mode] [Max Power Saving Mode]

2.4.5 OC Tuner

OC Tuner automatically overlocks the frequency and voltage of CPU and DRAM for enhancing the system performance. Press <Enter> and select **OK** to start automatic overclocking.

2.4.6 DRAM Timing Control

The sub-items in this menu allow you to set the DRAM timing control features. Use the <+> and <-> keys to adjust the value. To restore the default setting, type [auto] using the keyboard and press <Enter>.



Changing the values in this menu may cause the system to become unstable! If this happens, revert to the default settings.

2.4.7 CPU Voltage [Offset Mode]

[Offset Mode] To offset the voltage by a positive or negative value.

[Manual Mode] To set the voltage manually.

CPU Offset Mode Sign [+]

This item appears only when you set the **CPU Voltage** item to [Offset Mode].

[+] To offset the voltage by a positive value.

[-] To offset the voltage by a negative value.

CPU Offset Voltage [Auto]

Allows you to set the CPU Offset voltage. The values range from 0.00625V to 0.500V with a 0.00625V interval.



Refer to the CPU documentation before setting the CPU voltage. Setting a high voltage may damage the CPU permanently, and setting a low voltage may make the system unstable.

VDDNB Offset Mode Sign [+]

This item appears only when you set the **CPU Voltage** item to [Offset Mode].

[+] To offset the voltage by a positive value.

[-] To offset the voltage by a negative value.

VDDNB Offset Voltage [Auto]

Allows you to set the VDDNB Offset voltage. The values range from 0.00625V to 0.500V with a 0.00625V interval.

CPU Manual Voltage [Auto]

This item appears only when you set the **CPU Voltage** item to [Manual Mode] and allows you to manually set the CPU voltage. The values range from 0.800V to 1.550V with a 0.0125V interval.

VDDNB Manual Voltage [Auto]

This item appears only when you set the **CPU Voltage** item to [Manual Mode] and allows you to manually set the VDDNB voltage. The values range from 0.800V to 1.550V with a 0.0125V interval.

2.4.8 DRAM Voltage [Auto]

Allows you to set the DRAM voltage. The values range from 1.35V to 2.30V with a 0.01V interval.

2.4.9 SB 1.1V Voltage [Auto]

Allows you to set the Southbridge 1.1V voltage. The values range from 1.1V to 1.4V with a 0.01V interval.

2.4.10 1.1Vsb Voltage [Auto]

Allows you to set the 1.1Vsb voltage. The values range from 1.1000V to 1.2000V with a 0.1V interval.

2.4.11 APU1.2V Voltage [Auto]

Allows you to set the APU (Accelerated Processor Unit) 1.2V voltage. The values range from 1.2000V to 1.8000V with a 0.01V interval.

2.4.12 VDDA Voltage [Auto]

Allows you to set the VDDA voltage. The values range from 2.5000V to 2.8000V with a 0.1V interval.



-
- The values of the **CPU Offset Voltage**, **VDDNB Offset Voltage**, **DRAM Voltage**, **SB 1.1V Voltage**, **1.1Vsb Voltage**, **APU1.2V Voltage**, and **VDDA Voltage** items are labeled in different color, indicating the risk levels of high voltage settings.
 - The system may need better cooling system to work stably under high voltage settings.
-

2.4.13 DIGI + VRM

CPU Load Line Calibration [Auto]

CPU Load-line Calibration is defined by AMD VRM specifications and affects CPU voltage. The CPU working voltage will decrease proportionally to CPU loading. Higher load-line calibration would get higher voltage and better overclocking performance, but increase the CPU and VRM thermal. This item allows you to adjust the voltage range from the following percentages to boost the system performance: 0% (Regular), 25% (Medium), 50% (High), 75% (Ultra High) and 100% (Extreme). Configuration options: [Auto] [Regular] [Medium] [High] [Ultra High] [Extreme]



The actual performance boost may vary depending on your CPU specification.

CPU/NB Load Line Calibration [Auto]

Allows you to select the CPU/NB Load-Line Calibration mode. Configuration options: [Auto] [Regular] [High] [Extreme]

CPU Current Capability [100%]

This item provides wider total power range for overclocking. A higher value brings a wider total power range and extends the overclocking frequency range simultaneously. Configuration options: [100%] [110%] [120%] [130%] [140%]

CPU/NB Current Capability [100%]

This item provides wider total power range for overclocking. A higher value brings a wider total power range and extends the overclocking frequency range simultaneously. Configuration options: [100%] [110%] [120%] [130%]

CPU Power Phase Control [Standard]

Phase number is the number of working VRM phase. Increasing phase number under heavy system loading to get more transient and better thermal performance. Reducing phase number under light system loading to increase VRM efficiency.

- [Standard] Proceeds phase control depending on the CPU loading.
- [Optimized] Loads the ASUS optimized phase tuning profile.
- [Extreme] Proceeds the full phase mode.
- [Manual Adjustment] Allows manual adjustment.

CPU Voltage Frequency [Auto]

Switching frequency will affect the VRM transient response and component thermal. Setting a higher frequency gets faster transient response.

- [Auto] Allows you to enable or disable the Spread Spectrum item.
- [Manual] Allows you to manually set the frequency with a 10k Hz interval.

VRM Spread Spectrum [Disabled]

This item appears only when you set the CPU Voltage Frequency item to [Auto] and allows you to enable the spread spectrum to enhance system stability.

VRM Fixed Frequency Mode [xxx]

This item appears only when you set the CPU Voltage Frequency item to [Manual] and allows you to set a fixed VRM frequency. Use the <+> and <-> keys to adjust the value. The values range from 200k Hz to 400k Hz with a 10k Hz interval.

CPU Power Duty Control [T.Probe]

- [T.Probe] Maintains the VRM thermal balance.
- [Extreme] Maintains the VRM current balance.



Do not remove the thermal module while changing the DIGI+VRM related parameters. The thermal conditions should be monitored.

2.4.14 APU Spread Spectrum [Auto]

- [Auto] Automatic configuration.
- [Disabled] Enhances the PCIE overclocking ability.
- [Enabled] Sets to [Enabled] for EMI control.

2.5 Advanced menu

The Advanced menu items allow you to change the settings for the CPU and other system devices.



Be cautious when changing the settings of the Advanced menu items. Incorrect field values can cause the system to malfunction.

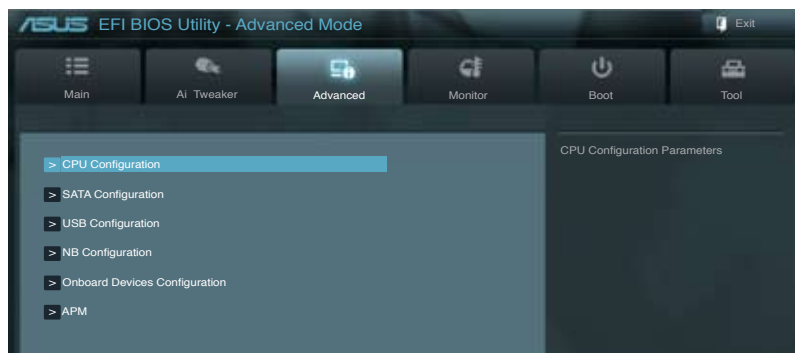

2.5.1 CPU Configuration

The items in this menu show the CPU-related information that the BIOS automatically detects.



The items shown in submenu may be different due to the CPU you installed.

Limit CPUID Maximum [Disabled]

[Enabled] Allows legacy operating systems to boot even without support for CPUs with extended CPUID functions.

[Disabled] Disables this function.

C6 Mode [Auto]

Enables or disables C6 mode. Configuration options: [Auto] [Enabled] [Disabled]

CPB Mode [Auto]

Disables the CPB (Core Performance Boost) mode or set it to [Auto] for automatic configuration. Configuration options: [Disabled] [Auto]

AMD PowerNow function [Enabled]

Enables or disables the AMD PowerNow function. Configuration options: [Enabled] [Disabled]

SVM [Enabled]

Enables or disables CPU virtualization. Configuration options: [Disabled] [Enabled]

2.5.2 SATA Configuration

While entering Setup, the BIOS automatically detects the presence of SATA devices. The SATA Port items show **Not Present** if no SATA device is installed to the corresponding SATA port.

OnChip SATA Channel [Enabled]

Enables or disables onboard channel SATA port. Configuration options: [Disabled] [Enabled]



The following three items appear only when you set the **OnChip SATA Channel** to [Enabled].

OnChip SATA Type [IDE]

Allows you to set the SATA configuration.

- [IDE] Set to [IDE] when you want to use the Serial ATA hard disk drives as Parallel ATA physical storage devices.
- [RAID] Set to [RAID] when you want to create a RAID configuration from the SATA hard disk drives.
- [AHCI] Set to [AHCI] when you want the SATA hard disk drives to use the AHCI (Advanced Host Controller Interface). The AHCI allows the onboard storage driver to enable advanced Serial ATA features that increases storage performance on random workloads by allowing the drive to internally optimize the order of commands.

SATA Port 5 - Port 6 [AHCI or RAID]

This item only appears when the previous item is set to [RAID] or [AHCI]. If Port 5-6 are configured as [AHCI or RAID], the ports can only be used under OS with driver installed. Set to [IDE] instead of [AHCI or RAID] to access devices on Port 5-6 before entering OS. Configuration options: [AHCI or RAID] [IDE]

OnChip SATA MAX Speed [SATA 6.0Gb/s]

Sets the maximum onboard SATA port speed. Configuration options: [SATA 3.0Gb/s] [SATA 6.0Gb/s]

S.M.A.R.T. Status Check [Enabled]

S.M.A.R.T. (Self-Monitoring, Analysis and Reporting Technology) is a monitor system. When read/write of your hard disk errors occur, this feature allows the hard disk to report warning messages during the POST. Configuration options: [Enabled] [Disabled]

2.5.3 USB Configuration

The items in this menu allow you to change the USB-related features.



The **USB Devices** item shows the auto-detected values. If no USB device is detected, the item shows None.

Legacy USB Support [Enabled]

- [Enabled] Enables the support for USB devices on legacy operating systems (OS).
- [Disabled] The USB devices can be used only for the BIOS setup program.
- [Auto] Allows the system to detect the presence of USB devices at startup. If detected, the USB controller legacy mode is enabled. If no USB device is detected, the legacy USB support is disabled.

Legacy USB3.0 Support [Enabled]

- [Enabled] Enables the support for USB 3.0 devices on legacy operating systems (OS).
- [Disabled] Disables the function.

EHCI Hand-off [Disabled]

- [Enabled] Enables the support for operating systems without an EHCI hand-off feature.
- [Disabled] Disables the function.

2.5.4 NB Configuration

IGFX Multi-Monitor [Disabled]

Enables or disables the Internal Graphics Device Multi-Monitor support for add-on VGA devices. And the memory size of Internal Graphics Device will keep memory reserved. Configuration options: [Disabled] [Enabled]

Primary Video Device [PCIe / PCI Video]

Selects the primary display device. Configuration options: [IGFX Video] [PCIe / PCI Video]

Integrated Graphics [Auto]

Enables the integrated graphics controller. Configuration options: [Auto] [Force]

UMA Frame Buffer Size [Auto]

This item appears only when you set the previous item to [Force]. Configuration options: [Auto] [32M] [64M] [128M] [256M] [384M]

HDMI/DVI Port Output [Auto]

Sets the HDMI/DVI port output type. Configuration options: [Auto] [HDMI] [DVI]

PCIe x16_1/DP Output [Auto]

Sets the PCIe x16_1 slot/DP port output type. Configuration options: [Auto] [PCIe x16_1] [DP]

2.5.5 Onboard Devices Configuration

HD Audio Device [Enabled]

- [Enabled] Enables the High Definition Audio Controller.
- [Disabled] Disables the controller.



The following two items appear only when you set the **HD Audio Device** item to [Enabled].

Front Panel Type [HD]

Allows you to set the front panel audio connector (AAFP) mode to legacy AC'97 or high-definition audio depending on the audio standard that the front panel audio module supports.

- [HD] Sets the front panel audio connector (AAFP) mode to high definition audio.
- [AC97] Sets the front panel audio connector (AAFP) mode to legacy AC'97.

SPDIF Out Type [SPDIF]

- [SPDIF] Sets to [SPDIF] for SPDIF audio output.
- [HDMI] Sets to [HDMI] for HDMI audio output.

ASM1061 Storage Controller [AHCI Mode]

- [Disabled] Disables the ASM1061 Storage controller.
- [IDE Mode] Enables the IDE Mode.
- [AHCI Mode] Enables the AHCI Mode.

ASM1061 Storage OPROM [Enabled]

- [Enabled] Enables the ASM1061 Storage OPROM.
- [Disabled] Disables the ASM1061 Storage OPROM.

Realtek LAN Controller [Enabled]

- [Enabled] Enables the Realtek LAN controller.
- [Disabled] Disables the controller.

Realtek PXE OPROM [Disabled]

This item appears only when you set the **Realtek LAN Controller** item to [Enabled] and allows you to enable or disable the Rom Help of the Realtek LAN controller.

Configuration options: [Enabled] [Disabled]

Asmedia USB 3.0 Controller [Enabled]

- [Enabled] Enables the onboard USB 3.0 controller.
- [Disabled] Disables the controller.

Asmedia USB 3.0 Battery Charging Support [Enabled]

This item appears only when the Asmedia USB 3.0 Controller item is set to [Enabled].

- [Enabled] Enables the Asmedia USB 3.0 battery charging function.
- [Disabled] Disables this function

Serial Port Configuration

The sub-items in this menu allow you to set the serial port configuration.

Serial Port [Enabled]

Allows you to enable or disable the serial port (COM).

Configuration options: [Enabled] [Disabled]

Change Settings [IO=3F8h; IRQ=4]

Allows you to select the Serial Port base address. Configuration options: [IO=3F8h; IRQ=4] [IO=2F8h; IRQ=3] [IO=3E8h; IRQ=4] [IO=2E8h; IRQ=3]

2.5.6 APM

Restore AC Power Loss [Power Off]

- [Power On] The system goes into on state after an AC power loss.
- [Power Off] The system goes into off state after an AC power loss.
- [Last State] The system goes into either off or on state, whatever the system state was before the AC power loss.

Power On By PS/2 Keyboard [Disabled]

- [Disabled] Disables the Power On by a PS/2 keyboard.
- [Space Bar] Sets the Space Bar on the PS/2 keyboard to turn on the system.
- [Ctrl-Esc] Sets the Ctrl+Esc key on the PS/2 keyboard to turn on the system.

[Power Key] Sets Power key on the PS/2 keyboard to turn on the system. This feature requires an ATX power supply that provides at least 1A on the +5VSB lead.

Power On By PME [Disabled]

[Disabled] Disables the PME to wake up by PCI/PCIE devices.

[Enabled] Allows you to turn on the system through a PCI/PCIE LAN or modem card. This feature requires an ATX power supply that provides at least 1A on the +5VSB lead.

Power On By Ring [Disabled]

[Disabled] Disables Ring to generate a wake event.

[Enabled] Enables Ring to generate a wake event.

Power On By RTC [Disabled]

[Disabled] Disables RTC to generate a wake event.

[Enabled] When set to [Enabled], the items **RTC Alarm Date (Days)** and **Hour/Minute/Second** will become user-configurable with set values.

Power On By PS/2 Mouse [Disabled]

[Disabled] Disables the Power On by a PS/2 mouse.

[Enabled] Enables the Power On by a PS/2 mouse. This feature requires an ATX power supply that provides at least 1A on the +5VSB lead.

2.6 Monitor menu

The Monitor menu displays the system temperature/power status, and allows you to change the fan settings.



2.6.1 CPU Temperature / MB Temperature [xxx°C/xxx°F]

The onboard hardware monitor automatically detects and displays the CPU and motherboard temperatures. Select **Ignore** if you do not wish to display the detected temperatures.

2.6.2 CPU / Chassis / Power Fan Speed [xxxx RPM] or [Ignore] / [N/A]

The onboard hardware monitor automatically detects and displays the CPU / chassis / Power fan speeds in rotations per minute (RPM). If the fan is not connected to the motherboard, the field shows **N/A**. Select **Ignore** if you do not wish to display the detected speed.

2.6.3 CPU Q-Fan Control [Disabled]

[Disabled] Disables the CPU Q-Fan control feature.

[Enabled] Enables the CPU Q-Fan control feature.

CPU Fan Speed Low Limit [600 RPM]

This item appears only when you enable the **CPU Q-Fan Control** feature and allows you to disable or set the CPU fan warning speed.

Configuration options: [Ignore] [200RPM] [300 RPM] [400 RPM] [500 RPM] [600 RPM]

CPU Fan Profile [Standard]

This item appears only when you enable the **CPU Q-Fan Control** feature and allows you to set the appropriate performance level of the CPU fan.

[Standard] Sets to [Standard] to make the CPU fan automatically adjust depending on the CPU temperature.

[Silent] Sets to [Silent] to minimize the fan speed for quiet CPU fan operation.

[Turbo] Sets to [Turbo] to achieve maximum CPU fan speed.

[Manual] Sets to [Manual] to assign detailed fan speed control parameters.



The following four items appear only when you set **CPU Fan Profile** to [Manual].

CPU Upper Temperature [70°C]

Use the <+> and <-> keys to adjust the upper limit of the CPU temperature. The values range from 20°C to 90°C.

CPU Fan Max. Duty Cycle(%) [100%]

Use the <+> and <-> keys to adjust the maximum CPU fan duty cycle. The values range from 40% to 100%. When the CPU temperature reaches the upper limit, the CPU fan will operate at the maximum duty cycle.

CPU Lower Temperature [20°C]

Use the <+> and <-> keys to adjust the lower limit of the CPU temperature. The values range from 20°C to 75°C.

CPU Fan Min. Duty Cycle(%) [40%]

Use the <+> and <-> keys to adjust the minimum CPU fan duty cycle. The values range from 40% to 100%. When the CPU temperature is under the lower limit, the CPU fan will operate at the minimum duty cycle.

2.6.4 Chassis Q-Fan Control [Disabled]

[Disabled] Disables the Chassis Q-Fan control feature.

[Enabled] Enables the Chassis Q-Fan control feature.

Chassis Fan Speed Low Limit [600 RPM]

This item appears only when you enable the **Chassis Q-Fan Control** feature and allows you to disable or set the chassis fan warning speed.

Configuration options: [Ignore] [200RPM] [300 RPM] [400 RPM] [500 RPM] [600 RPM]

Chassis Fan Profile [Standard]

This item appears only when you enable the **Chassis Q-Fan Control** feature and allows you to set the appropriate performance level of the chassis fan.

[Standard] Sets to [Standard] to make the chassis fan automatically adjust depending on the chassis temperature.

[Silent] Sets to [Silent] to minimize the fan speed for quiet chassis fan operation.

[Turbo] Sets to [Turbo] to achieve maximum chassis fan speed.

[Manual] Sets to [Manual] to assign detailed fan speed control parameters.



The following four items appear only when you set **Chassis Fan Profile** to [Manual].

Chassis Upper Temperature [70°C]

Use the <+> and <-> keys to adjust the upper limit of the CPU temperature. The values range from 20°C to 90°C.

Chassis Fan Max. Duty Cycle(%) [100%]

Use the <+> and <-> keys to adjust the maximum chassis fan duty cycle. The values range from 40% to 100%. When the chassis temperature reaches the upper limit, the chassis fan will operate at the maximum duty cycle.

Chassis Lower Temperature [20°C]

Displays the lower limit of the chassis temperature.

CPU Fan Min. Duty Cycle(%) [40%]

Use the <+> and <-> keys to adjust the minimum chassis fan duty cycle. The values range from 40% to 100%. When the chassis temperature is under 40°C, the chassis fan will operate at the minimum duty cycle.

2.6.5 CPU Voltage, 3.3V Voltage, 5V Voltage, 12V Voltage

The onboard hardware monitor automatically detects the voltage output through the onboard voltage regulators. Select **Ignore** if you do not want to detect this item.

2.6.6 Anti Surge Support [Enabled]

This item allows you to enable or disable the Anti Surge function.

Configuration options: [Disabled] [Enabled]

2.7 Boot menu

The Boot menu items allow you to change the system boot options.

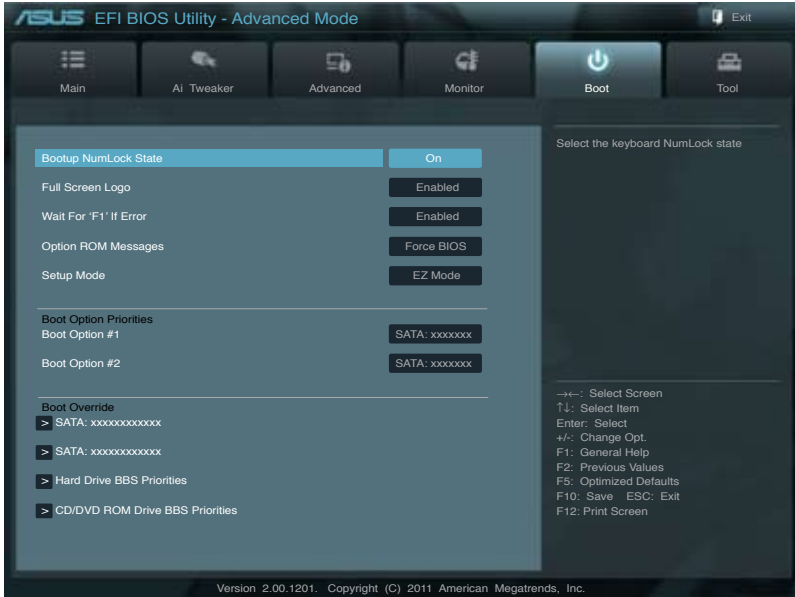

2.7.1 Bootup NumLock State [On]

[On] Sets the power-on state of the NumLock to [On].

[Off] Sets the power-on state of the NumLock to [Off].

2.7.2 Full Screen Logo [Enabled]

[Enabled] Enables the full screen logo display feature.

[Disabled] Disables the full screen logo display feature.



Set this item to [Enabled] to use the ASUS MyLogo 2™ feature.

Post Report [5 sec]

This item appears only when the Full Screen Logo item is set to [Disabled] and allows you to set the waiting time for the system to display the post report. Configuration options: [1 sec] [2 sec] [3 sec] [4 sec] [5 sec] [6 sec] [7 sec] [8 sec] [9 sec] [10 sec] [Until Press ESC]

2.7.3 Wait for 'F1' If Error [Enabled]

When this item is set to [Enabled], the system waits for the F1 key to be pressed when error occurs. Configuration options: [Disabled] [Enabled]

2.7.4 Option ROM Messages [Force BIOS]

[Force BIOS] The third-party ROM messages will be forced to display during the boot sequence.

[Keep Current] The third-party ROM messages will be displayed only if the third-party manufacturer had set the add-on device to do so.

2.7.5 Setup Mode [EZ Mode]

[Advanced Mode] Sets Advanced Mode as the default screen for entering the BIOS setup program.

[EZ Mode] Sets EZ Mode as the default screen for entering the BIOS setup program.

2.7.6 Boot Option Priorities

These items specify the boot device priority sequence from the available devices. The number of device items that appears on the screen depends on the number of devices installed in the system.



-
- To select the boot device during system startup, press <F8> when ASUS Logo appears.
 - To access Windows OS in Safe Mode, press <F8> after POST.
-

2.7.7 Boot Override

These items displays the available devices. The number of device items that appears on the screen depends on the number of devices installed in the system. Click an item to start booting from the selected device.

2.8 Tools menu

The Tools menu items allow you to configure options for special functions. Select an item then press <Enter> to display the submenu.

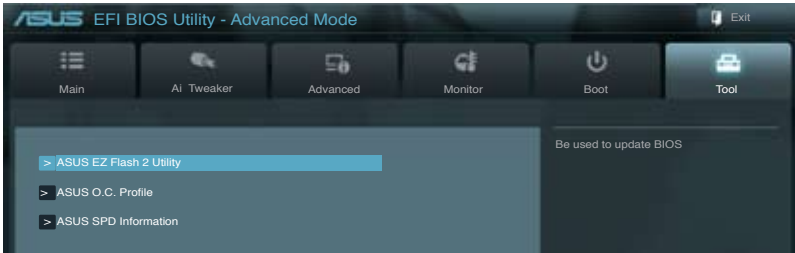

2.8.1 ASUS EZ Flash 2 Utility

Allows you to run ASUS EZ Flash 2. Press [Enter] to launch the ASUS EZ Flash 2 screen.



For more details, see section 2.1.2 **ASUS EZ Flash 2**.

2.8.2 ASUS O.C. Profile

This item allows you to store or load multiple BIOS settings.



The **Setup Profile Status** items show **Not Installed** if no profile is created.

Save to Profile

Allows you to save the current BIOS settings to the BIOS Flash, and create a profile. Key in a profile number from one to eight, press <Enter>, and then select **Yes**.

Load from Profile

Allows you to load the previous BIOS settings saved in the BIOS Flash. Key in the profile number that saved your CMOS settings, press <Enter>, and then select **Yes**.



-
- DO NOT shut down or reset the system while updating the BIOS to prevent the system boot failure!
 - We recommend that you update the BIOS file only coming from the same memory/CPU configuration and BIOS version.
-

2.8.3 ASUS SPD Information

DIMM Slot # [DIMM_A1]

Displays the Serial Presence Detect (SPD) information of the DIMM module installed on the selected slot. Configuration options: [DIMM_A1] [DIMM_A2] [DIMM_B1] [DIMM_B2]

2.9 Exit menu

The Exit menu items allow you to load the optimal default values for the BIOS items, and save or discard your changes to the BIOS items. You can access the **EZ Mode** from the Exit menu.

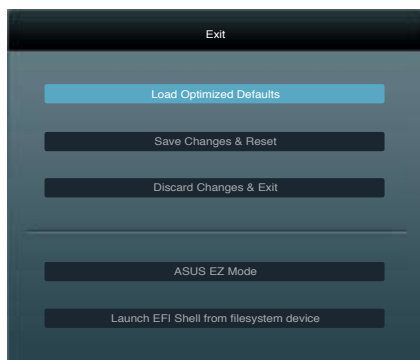

Load Optimized Defaults

This option allows you to load the default values for each of the parameters on the Setup menus. When you select this option or if you press <F5>, a confirmation window appears. Select **Yes** to load the default values.

Save Changes & Reset

Once you are finished making your selections, choose this option from the Exit menu to ensure the values you selected are saved. When you select this option or if you press <F10>, a confirmation window appears. Select **Yes** to save changes and exit.

Discard Changes & Exit

This option allows you to exit the Setup program without saving your changes. When you select this option or if you press <Esc>, a confirmation window appears. Select **Yes** to discard changes and exit.

ASUS EZ Mode

This option allows you to enter the EZ Mode screen.

Launch EFI Shell from filesystem device

This option allows you to attempt to launch the UEFI Shell application (shellx64.efi) from one of the available devices that have a filesystem.

ASUS contact information

ASUSTeK COMPUTER INC.

Address	15 Li-Te Road, Peitou, Taipei, Taiwan 11259
Telephone	+886-2-2894-3447
Fax	+886-2-2890-7798
E-mail	info@asus.com.tw
Web site	www.asus.com.tw

Technical Support

Telephone	+86-21-38429911
Online support	support.asus.com

ASUS COMPUTER INTERNATIONAL (America)

Address	800 Corporate Way, Fremont, CA 94539, USA
Telephone	+1-510-739-3777
Fax	+1-510-608-4555
Web site	usa.asus.com

Technical Support

Telephone	+1-812-282-2787
Support fax	+1-812-284-0883
Online support	support.asus.com

ASUS COMPUTER GmbH (Germany and Austria)

Address	Harkort Str. 21-23, D-40880 Ratingen, Germany
Fax	+49-2102-959911
Web site	www.asus.de
Online contact	www.asus.de/sales

Technical Support

Telephone (Component)	+49-1805-010923*
Telephone (System/Notebook/Eee/LCD)	+49-1805-010920*
Support Fax	+49-2102-9599-11
Online support	support.asus.com

* EUR 0.14/minute from a German fixed landline; EUR 0.42/minute from a mobile phone.

DECLARATION OF CONFORMITY

Per FCC Part 2, Section 2.1077(a)



Responsible Party Name: **Asus Computer International**

Address: **800 Corporate Way, Fremont, CA 94539.**

Phone/Fax No.: **(510)739-3777/(510)608-4555**

hereby declares that the product

Product Name : Motherboard

Model Number : F1A75-V EVO

Conforms to the following specifications:

- FCC Part 15, Subpart B, Unintentional Radiators
- FCC Part 15, Subpart C, Intentional Radiators
- FCC Part 15, Subpart E, Intentional Radiators

Supplementary Information:

This device complies with part 15 of the FCC Rules. Operation is subject to the following two conditions: (1) This device may not cause harmful interference, and (2) this device must accept any interference received, including interference that may cause undesired operation.

Representative Person's Name : Steve Chang / President

Signature :

Date : Jun. 20, 2011

EC Declaration of Conformity



We, the undersigned,

Manufacturer: **ASUSTEK COMPUTER INC.**
Address, city: **No. 150, LITE RD., PEITOU, TAIPEI 112, TAIWAN R.O.C.**
Country: **TAIWAN**
Authorized representative in Europe: **ASUS COMPUTER GmbH**
Address, city: **HARKORT STR. 21-23, 40880 RATINGEN**
Country: **GERMANY**

declare the following apparatus:

Product name : **Motherboard**
Model name : **F1A75-V EVO**

conform with the essential requirements of the following directives:

2004/108/EC-EMC Directive
 EN 60950-1:2005+A1:2007
 EN 61000-3-2:2006
 EN 55013:2001+A1:2003+A2:2006
 EN 55020:2007

1989/6/EC-R & TTE Directive

EN 300 328 V1.7.1(2006-05)
 EN 300 440-1 V1.4.1(2006-05)
 EN 300 440-2 V1.2.1(2006-05)
 EN 300 440-3 V1.3.1(2007-08)
 EN 301 885-1 V1.1.1(2007-05)
 EN 301 885-2 V1.2.1(2007-11)
 EN 301 885-3 V1.3.1(2007-11)
 EN 301 885-4 V1.4.1(2007-11)
 EN 301 885-5 V1.5.1(2007-11)
 EN 301 885-6 V1.6.1(2007-11)
 EN 301 885-7 V1.7.1(2009-05)
 EN 301 885-8 V1.8.1(2008-04)
 EN 301 885-9 V1.9.1(2008-04)
 EN 301 885-10 V1.10.1(2008-04)
 EN 301 885-11 V1.11.1(2008-04)
 EN 301 885-12 V1.12.1(2008-04)
 EN 301 885-13 V1.13.1(2008-04)
 EN 301 885-14 V1.14.1(2008-04)
 EN 301 885-15 V1.15.1(2008-04)
 EN 301 885-16 V1.16.1(2008-04)
 EN 301 885-17 V1.17.1(2008-04)
 EN 301 885-18 V1.18.1(2008-04)
 EN 301 885-19 V1.19.1(2008-04)
 EN 301 885-20 V1.20.1(2008-04)
 EN 301 885-21 V1.21.1(2008-04)
 EN 301 885-22 V1.22.1(2008-04)
 EN 301 885-23 V1.23.1(2008-04)
 EN 301 885-24 V1.24.1(2008-04)
 EN 301 885-25 V1.25.1(2008-04)
 EN 301 885-26 V1.26.1(2008-04)
 EN 301 885-27 V1.27.1(2008-04)
 EN 301 885-28 V1.28.1(2008-04)
 EN 301 885-29 V1.29.1(2008-04)
 EN 301 885-30 V1.30.1(2008-04)
 EN 301 885-31 V1.31.1(2008-04)
 EN 301 885-32 V1.32.1(2008-04)
 EN 301 885-33 V1.33.1(2008-04)
 EN 301 885-34 V1.34.1(2008-04)
 EN 301 885-35 V1.35.1(2008-04)
 EN 301 885-36 V1.36.1(2008-04)
 EN 301 885-37 V1.37.1(2008-04)
 EN 301 885-38 V1.38.1(2008-04)
 EN 301 885-39 V1.39.1(2008-04)
 EN 301 885-40 V1.40.1(2008-04)
 EN 301 885-41 V1.41.1(2008-04)
 EN 301 885-42 V1.42.1(2008-04)
 EN 301 885-43 V1.43.1(2008-04)
 EN 301 885-44 V1.44.1(2008-04)
 EN 301 885-45 V1.45.1(2008-04)
 EN 301 885-46 V1.46.1(2008-04)
 EN 301 885-47 V1.47.1(2008-04)
 EN 301 885-48 V1.48.1(2008-04)
 EN 301 885-49 V1.49.1(2008-04)
 EN 301 885-50 V1.50.1(2008-04)
 EN 301 885-51 V1.51.1(2008-04)
 EN 301 885-52 V1.52.1(2008-04)
 EN 301 885-53 V1.53.1(2008-04)
 EN 301 885-54 V1.54.1(2008-04)
 EN 301 885-55 V1.55.1(2008-04)
 EN 301 885-56 V1.56.1(2008-04)
 EN 301 885-57 V1.57.1(2008-04)
 EN 301 885-58 V1.58.1(2008-04)
 EN 301 885-59 V1.59.1(2008-04)
 EN 301 885-60 V1.60.1(2008-04)
 EN 301 885-61 V1.61.1(2008-04)
 EN 301 885-62 V1.62.1(2008-04)
 EN 301 885-63 V1.63.1(2008-04)
 EN 301 885-64 V1.64.1(2008-04)
 EN 301 885-65 V1.65.1(2008-04)
 EN 301 885-66 V1.66.1(2008-04)
 EN 301 885-67 V1.67.1(2008-04)
 EN 301 885-68 V1.68.1(2008-04)
 EN 301 885-69 V1.69.1(2008-04)
 EN 301 885-70 V1.70.1(2008-04)
 EN 301 885-71 V1.71.1(2008-04)
 EN 301 885-72 V1.72.1(2008-04)
 EN 301 885-73 V1.73.1(2008-04)
 EN 301 885-74 V1.74.1(2008-04)
 EN 301 885-75 V1.75.1(2008-04)
 EN 301 885-76 V1.76.1(2008-04)
 EN 301 885-77 V1.77.1(2008-04)
 EN 301 885-78 V1.78.1(2008-04)
 EN 301 885-79 V1.79.1(2008-04)
 EN 301 885-80 V1.80.1(2008-04)
 EN 301 885-81 V1.81.1(2008-04)
 EN 301 885-82 V1.82.1(2008-04)
 EN 301 885-83 V1.83.1(2008-04)
 EN 301 885-84 V1.84.1(2008-04)
 EN 301 885-85 V1.85.1(2008-04)
 EN 301 885-86 V1.86.1(2008-04)
 EN 301 885-87 V1.87.1(2008-04)
 EN 301 885-88 V1.88.1(2008-04)
 EN 301 885-89 V1.89.1(2008-04)
 EN 301 885-90 V1.90.1(2008-04)
 EN 301 885-91 V1.91.1(2008-04)
 EN 301 885-92 V1.92.1(2008-04)
 EN 301 885-93 V1.93.1(2008-04)
 EN 301 885-94 V1.94.1(2008-04)
 EN 301 885-95 V1.95.1(2008-04)
 EN 301 885-96 V1.96.1(2008-04)
 EN 301 885-97 V1.97.1(2008-04)
 EN 301 885-98 V1.98.1(2008-04)
 EN 301 885-99 V1.99.1(2008-04)
 EN 301 885-100 V1.100.1(2008-04)

2006/95/EC-LVD Directive

EN 60950-1:2006
 EN 60950-1:2006+A11:2009

2009/128/EC-ERP Directive

Regulation (EC) No. 1275/2008
 EN 62301:2005
Regulation (EC) No. 642/2009
 EN 62301:2005

Ver. 10/06

CE marking



(EC conformity marking)

Position : **CEO**
Name : **Jerry Shen**

Signature : _____

Declaration Date: **Jun.20, 2011**
Year to begin affixing CE marking: **2011**