

**SABERTOOTH  
X79**

**ASUS**<sup>®</sup>

**Motherboard**

E8040

Revised Edition V3  
January 2013

**Copyright © 2013 ASUSTeK COMPUTER INC. All Rights Reserved.**

No part of this manual, including the products and software described in it, may be reproduced, transmitted, transcribed, stored in a retrieval system, or translated into any language in any form or by any means, except documentation kept by the purchaser for backup purposes, without the express written permission of ASUSTeK COMPUTER INC. ("ASUS").

Product warranty or service will not be extended if: (1) the product is repaired, modified or altered, unless such repair, modification of alteration is authorized in writing by ASUS; or (2) the serial number of the product is defaced or missing.

ASUS PROVIDES THIS MANUAL "AS IS" WITHOUT WARRANTY OF ANY KIND, EITHER EXPRESS OR IMPLIED, INCLUDING BUT NOT LIMITED TO THE IMPLIED WARRANTIES OR CONDITIONS OF MERCHANTABILITY OR FITNESS FOR A PARTICULAR PURPOSE. IN NO EVENT SHALL ASUS, ITS DIRECTORS, OFFICERS, EMPLOYEES OR AGENTS BE LIABLE FOR ANY INDIRECT, SPECIAL, INCIDENTAL, OR CONSEQUENTIAL DAMAGES (INCLUDING DAMAGES FOR LOSS OF PROFITS, LOSS OF BUSINESS, LOSS OF USE OR DATA, INTERRUPTION OF BUSINESS AND THE LIKE), EVEN IF ASUS HAS BEEN ADVISED OF THE POSSIBILITY OF SUCH DAMAGES ARISING FROM ANY DEFECT OR ERROR IN THIS MANUAL OR PRODUCT.

SPECIFICATIONS AND INFORMATION CONTAINED IN THIS MANUAL ARE FURNISHED FOR INFORMATIONAL USE ONLY, AND ARE SUBJECT TO CHANGE AT ANY TIME WITHOUT NOTICE, AND SHOULD NOT BE CONSTRUED AS A COMMITMENT BY ASUS. ASUS ASSUMES NO RESPONSIBILITY OR LIABILITY FOR ANY ERRORS OR INACCURACIES THAT MAY APPEAR IN THIS MANUAL, INCLUDING THE PRODUCTS AND SOFTWARE DESCRIBED IN IT.

Products and corporate names appearing in this manual may or may not be registered trademarks or copyrights of their respective companies, and are used only for identification or explanation and to the owners' benefit, without intent to infringe.

**Offer to Provide Source Code of Certain Software**

This product may contain copyrighted software that is licensed under the General Public License ("GPL") and under the Lesser General Public License Version ("LGPL"). The GPL and LGPL licensed code in this product is distributed without any warranty. Copies of these licenses are included in this product.

You may obtain the complete corresponding source code (as defined in the GPL) for the GPL Software, and/or the complete corresponding source code of the LGPL Software (with the complete machine-readable "work that uses the Library") for a period of three years after our last shipment of the product including the GPL Software and/or LGPL Software, which will be no earlier than December 1, 2011, either (1) for free by downloading it from <http://support.asus.com/download>;

or

(2) for the cost of reproduction and shipment, which is dependent on the preferred carrier and the location where you want to have it shipped to, by sending a request to:

ASUSTeK Computer Inc.  
Legal Compliance Dept.  
15 Li Te Rd.,  
Beitou, Taipei 112  
Taiwan

In your request please provide the name, model number and version, as stated in the About Box of the product for which you wish to obtain the corresponding source code and your contact details so that we can coordinate the terms and cost of shipment with you.

The source code will be distributed WITHOUT ANY WARRANTY and licensed under the same license as the corresponding binary/object code.

This offer is valid to anyone in receipt of this information.

ASUSTeK is eager to duly provide complete source code as required under various Free Open Source Software licenses. If however you encounter any problems in obtaining the full corresponding source code we would be much obliged if you give us a notification to the email address [gpl@asus.com](mailto:gpl@asus.com), stating the product and describing the problem (please do NOT send large attachments such as source code archives etc to this email address).

# Contents

Contents.....	iii
Notices vi	
Safety information.....	vii
About this guide.....	viii
SABERTOOTH X79 specifications summary.....	x
<b>Chapter 1: Product introduction</b>	
1.1 Welcome!.....	1-1
1.2 Package contents.....	1-1
1.3 Special features.....	1-2
1.3.1 Product highlights.....	1-2
1.3.2 “Ultimate COOL!” Thermal Solutions .....	1-3
1.3.3 “TUF ENGINE!” Power Design.....	1-3
1.3.4 “Safe & Stable!” Guardian Angel .....	1-4
1.3.5 ASUS EZ DIY.....	1-4
1.3.6 ASUS Exclusive Features .....	1-5
1.3.7 Other special features .....	1-5
<b>Chapter 2: Hardware information</b>	
2.1 Before you proceed .....	2-1
2.2 Motherboard overview.....	2-2
2.2.1 Motherboard layout .....	2-2
2.2.2 Central Processing Unit (CPU) .....	2-4
2.2.3 System memory .....	2-5
2.2.4 Expansion slots.....	2-12
2.2.5 Jumper .....	2-14
2.2.6 Onboard switch .....	2-15
2.2.7 Onboard LEDs .....	2-16
2.2.8 Internal connectors.....	2-17
2.3 Building your computer system .....	2-26
2.3.1 Additional tools and components to build a PC system .....	2-26
2.3.2 CPU installation.....	2-27
2.3.3 CPU heatsink and fan assembly installation .....	2-29
2.3.4 DIMM installation.....	2-30
2.3.5 Motherboard installation.....	2-31
2.3.6 Thermal Armor for ASUS SABERTOOTH X79 .....	2-33
2.3.7 ATX Power connection.....	2-35
2.3.8 SATA device connection.....	2-36
2.3.9 Front I/O Connector .....	2-37

# Contents

2.3.10	Expansion Card installation.....	2-38
2.3.11	Rear panel connection.....	2-39
2.3.12	Audio I/O connections.....	2-41
2.3.13	USB BIOS Flashback.....	2-43
<b>2.4</b>	<b>Starting up for the first time.....</b>	<b>2-44</b>
<b>2.5</b>	<b>Turning off the computer.....</b>	<b>2-44</b>

## Chapter 3: BIOS setup

<b>3.1</b>	<b>Knowing BIOS.....</b>	<b>3-1</b>
<b>3.2</b>	<b>BIOS setup program.....</b>	<b>3-1</b>
3.2.1	EZ Mode.....	3-2
3.2.2	Advanced Mode.....	3-3
<b>3.3</b>	<b>Main menu.....</b>	<b>3-5</b>
<b>3.4</b>	<b>Ai Tweaker menu.....</b>	<b>3-7</b>
<b>3.5</b>	<b>Advanced menu.....</b>	<b>3-17</b>
3.5.1	CPU Configuration.....	3-18
3.5.2	PCH Configuration.....	3-20
3.5.3	SATA Configuration.....	3-20
3.5.4	USB Configuration.....	3-22
3.5.5	Onboard Devices Configuraton.....	3-23
3.5.6	APM.....	3-25
<b>3.6</b>	<b>Monitor menu.....</b>	<b>3-26</b>
<b>3.7</b>	<b>Boot menu.....</b>	<b>3-30</b>
<b>3.8</b>	<b>Tool menu.....</b>	<b>3-32</b>
3.8.1	ASUS EZ Flash 2 Utility.....	3-32
3.8.2	ASUS DRAM SPD Information.....	3-33
3.8.3	ASUS O.C. Profile.....	3-34
3.8.4	ASUS Drive Xpert.....	3-35
<b>3.9</b>	<b>Exit menu.....</b>	<b>3-36</b>
<b>3.10</b>	<b>Updating BIOS.....</b>	<b>3-37</b>
3.10.1	ASUS Update utility.....	3-37
3.10.2	ASUS EZ Flash 2 utility.....	3-40
3.10.3	ASUS CrashFree BIOS 3 utility.....	3-41
3.10.4	ASUS BIOS Updater.....	3-42

## Chapter 4: Software support

<b>4.1</b>	<b>Installing an operating system.....</b>	<b>4-1</b>
<b>4.2</b>	<b>Support DVD information.....</b>	<b>4-1</b>
4.2.1	Running the support DVD.....	4-1

# Contents

4.2.2	Obtaining the software manuals.....	4-2
<b>4.3</b>	<b>Software information .....</b>	<b>4-3</b>
4.3.1	AI Suite II.....	4-3
4.3.2	ASUS TUF Thermal Radar .....	4-4
4.3.3	TurboV EVO.....	4-8
4.3.4	DIGI+ Power Control.....	4-11
4.3.5	Sensor Recorder .....	4-13
4.3.6	USB 3.0 Boost.....	4-14
4.3.7	ASUS SSD Caching.....	4-15
4.3.8	ASUS Update.....	4-16
4.3.9	MyLogo2 .....	4-17
4.3.10	Audio configurations.....	4-19
<b>4.4</b>	<b>RAID configurations .....</b>	<b>4-20</b>
4.4.1	RAID definitions .....	4-20
4.4.2	Installing Serial ATA hard disks .....	4-21
4.4.3	Setting the RAID item in BIOS .....	4-21
4.4.4	Intel® Rapid Storage Technology Option ROM utility .....	4-21
4.4.5	Marvell RAID utility.....	4-25
<b>4.5</b>	<b>Creating a RAID driver disk.....</b>	<b>4-29</b>
4.5.1	Creating a RAID driver disk without entering the OS.....	4-29
4.5.2	Creating a RAID driver disk in Windows®.....	4-29
4.5.3	Installing the RAID driver during Windows® OS installation.....	4-30
4.5.4	Using a USB floppy disk drive.....	4-31
 <b>Chapter 5: Multiple GPU technology support</b>		
<b>5.1</b>	<b>AMD® CrossFireX™ technology .....</b>	<b>5-1</b>
5.1.1	Requirements.....	5-1
5.1.2	Before you begin .....	5-1
5.1.3	Installing two CrossFireX™ graphics cards .....	5-2
5.1.4	Installing the device drivers.....	5-3
5.1.5	Enabling the AMD® CrossFireX™ technology.....	5-3
<b>5.2</b>	<b>NVIDIA® SLI™ technology .....</b>	<b>5-4</b>
5.2.1	Requirements.....	5-4
5.2.2	Installing two SLI-ready graphics cards .....	5-4
5.2.3	Installing the device drivers.....	5-5
5.2.4	Enabling the NVIDIA® SLI™ technology .....	5-5

# Notices

## Federal Communications Commission Statement

This device complies with Part 15 of the FCC Rules. Operation is subject to the following two conditions:

- This device may not cause harmful interference, and
- This device must accept any interference received including interference that may cause undesired operation.

This equipment has been tested and found to comply with the limits for a Class B digital device, pursuant to Part 15 of the FCC Rules. These limits are designed to provide reasonable protection against harmful interference in a residential installation. This equipment generates, uses and can radiate radio frequency energy and, if not installed and used in accordance with manufacturer's instructions, may cause harmful interference to radio communications. However, there is no guarantee that interference will not occur in a particular installation. If this equipment does cause harmful interference to radio or television reception, which can be determined by turning the equipment off and on, the user is encouraged to try to correct the interference by one or more of the following measures:

- Reorient or relocate the receiving antenna.
- Increase the separation between the equipment and receiver.
- Connect the equipment to an outlet on a circuit different from that to which the receiver is connected.
- Consult the dealer or an experienced radio/TV technician for help.



---

The use of shielded cables for connection of the monitor to the graphics card is required to assure compliance with FCC regulations. Changes or modifications to this unit not expressly approved by the party responsible for compliance could void the user's authority to operate this equipment.

---

## Canadian Department of Communications Statement

This digital apparatus does not exceed the Class B limits for radio noise emissions from digital apparatus set out in the Radio Interference Regulations of the Canadian Department of Communications.

This class B digital apparatus complies with Canadian ICES-003.

## REACH

Complying with the REACH (Registration, Evaluation, Authorisation, and Restriction of Chemicals) regulatory framework, we published the chemical substances in our products at ASUS REACH website at <http://csr.asus.com/english/REACH.htm>.



---

**DO NOT** throw the motherboard in municipal waste. This product has been designed to enable proper reuse of parts and recycling. This symbol of the crossed out wheeled bin indicates that the product (electrical and electronic equipment) should not be placed in municipal waste. Check local regulations for disposal of electronic products.

---



---

**DO NOT** throw the mercury-containing button cell battery in municipal waste. This symbol of the crossed out wheeled bin indicates that the battery should not be placed in municipal waste.

---

# Safety information

## Electrical safety

- To prevent electrical shock hazard, disconnect the power cable from the electrical outlet before relocating the system.
- When adding or removing devices to or from the system, ensure that the power cables for the devices are unplugged before the signal cables are connected. If possible, disconnect all power cables from the existing system before you add a device.
- Before connecting or removing signal cables from the motherboard, ensure that all power cables are unplugged.
- Seek professional assistance before using an adapter or extension cord. These devices could interrupt the grounding circuit.
- Ensure that your power supply is set to the correct voltage in your area. If you are not sure about the voltage of the electrical outlet you are using, contact your local power company.
- If the power supply is broken, do not try to fix it by yourself. Contact a qualified service technician or your retailer.

## Operation safety

- Before installing the motherboard and adding devices on it, carefully read all the manuals that came with the package.
- Before using the product, ensure all cables are correctly connected and the power cables are not damaged. If you detect any damage, contact your dealer immediately.
- To avoid short circuits, keep paper clips, screws, and staples away from connectors, slots, sockets and circuitry.
- Avoid dust, humidity, and temperature extremes. Do not place the product in any area where it may become wet.
- Place the product on a stable surface.
- If you encounter technical problems with the product, contact a qualified service technician or your retailer.

# About this guide

This user guide contains the information you need when installing and configuring the motherboard.

## How this guide is organized

This guide contains the following parts:

- **Chapter 1: Product introduction**  
This chapter describes the features of the motherboard and the new technology it supports.
- **Chapter 2: Hardware information**  
This chapter lists the hardware setup procedures that you have to perform when installing system components. It includes description of the switches, jumpers, and connectors on the motherboard.
- **Chapter 3: BIOS setup**  
This chapter tells how to change system settings through the BIOS Setup menus. Detailed descriptions of the BIOS parameters are also provided.
- **Chapter 4: Software support**  
This chapter describes the contents of the support DVD that comes with the motherboard package and the software.
- **Chapter 5: Multiple GPU technology support**  
This chapter describes how to install and configure multiple ATI® CrossFireX™ and NVIDIA® SLI™ graphics cards.

## Where to find more information

Refer to the following sources for additional information and for product and software updates.

1. **ASUS websites**  
The ASUS website provides updated information on ASUS hardware and software products. Refer to the ASUS contact information.
2. **Optional documentation**  
Your product package may include optional documentation, such as warranty flyers, that may have been added by your dealer. These documents are not part of the standard package.



## Conventions used in this guide

To ensure that you perform certain tasks properly, take note of the following symbols used throughout this manual.



**DANGER/WARNING:** Information to prevent injury to yourself when trying to complete a task.



**CAUTION:** Information to prevent damage to the components when trying to complete a task.



**IMPORTANT:** Instructions that you **MUST** follow to complete a task.



**NOTE:** Tips and additional information to help you complete a task.

## Typography

### **Bold text**

Indicates a menu or an item to select.

### *Italics*

Used to emphasize a word or a phrase.

### <Key>

Keys enclosed in the less-than and greater-than sign means **that you must press the enclosed key.**

Example: <Enter> means that you must press the Enter or Return key.

### <Key1> + <Key2> + <Key3>

If you must press two or more keys simultaneously, the key names are linked with a plus sign (+).

Example: <Ctrl> + <Alt> + <Del>

# SABERTOOTH X79 specifications summary

<b>CPU</b>	Intel® Socket 2011 for 2nd Generation Intel® Core™ i7 Processor Extreme Edition Supports Intel® Turbo Boost Technology 2.0 * Refer to <a href="http://www.asus.com">www.asus.com</a> for Intel CPU support list
<b>Chipset</b>	Intel® X79 Express Chipset
<b>Memory</b>	8 x DIMM, Max. 64GB*, DDR3 1866/1600/1333/1066 MHz, ECC/non-ECC, un-buffered memory Quad channel memory architecture Supports Intel® Extreme Memory Profile (XMP) * Hyper DIMM support is subject to the physical characteristics of individual CPUs. ** Refer to <a href="http://www.asus.com">www.asus.com</a> or this user manual for the Memory QVL (Qualified Vendors Lists)
<b>Expansion Slots</b>	2 x PCI Express 3.0 x16 slots (dual at x16/x16 mode) 1 x PCI Express 3.0 x16 slot (PCIe x16_3 at x8 speed) 2 x PCI Express 2.0 x1 slots 1 x PCI slot * This motherboard is ready to support PCIe 3.0 SPEC. Functions will be available when using PCIe 3.0-compliant devices. Please refer to <a href="http://www.asus.com">www.asus.com</a> for updated details.
<b>Multi-GPU Support</b>	Supports NVIDIA® Quad-GPU SLI™ Technology Supports AMD® Quad-GPU CrossFireX™ Technology
<b>Storage</b>	<b>Intel® X79 Express Chipset</b> - 2 x SATA 6Gb/s ports with RAID 0,1,5 and 10 support (brown) - 4 x SATA 3Gb/s ports with RAID 0,1,5 and 10 support (black) <b>Marvell® 9128 SATA controller</b> - 2 x SATA 6Gb/s ports (gray) <b>ASMedia® 1061 SATA controller</b> - 1 x Power eSATA 6Gb/s port (green) - 1 x eSATA 6Gb/s port (red)
<b>LAN</b>	Intel® 82579V Gigabit LAN controller
<b>Audio</b>	Realtek® ALC892 8-channel High Definition Audio CODEC - Absolute Pitch 192khz/24bit True BD Lossless Sound - BD Audio Layer Content Protection - Supports Jack-Detection, Multi-Streaming and Front Panel Jack-Retasking - Optical S/PDIF Out port at back I/O
<b>IEEE 1394</b>	VIA® VT6315N controller supports 1 IEEE 1394a port at back panel
<b>USB</b>	<b>3 x ASMedia® USB 3.0 controllers</b> - 2 x USB 3.0 ports at midboard for front panel support - 4 x USB 3.0 ports at back panel (blue) <b>Intel® X79 Express Chipset</b> - 14 x USB 2.0/1.1 ports (8 ports at midboard; 6 ports at back panel)

*(continued on the next page)*

# SABERTOOTH X79 specifications summary

<b>Exclusive TUF Features</b>	<p><b>“Ultimate COOL!” Thermal Solutions</b></p> <ul style="list-style-type: none"> <li>- TUF Thermal Armor</li> <li>- TUF Thermal Radar</li> </ul> <p><b>“TUF ENGINE!” Power Design</b></p> <ul style="list-style-type: none"> <li>- 8+2+2+2 Digital Phase Power Design</li> <li>- TUF Components (Choke, Cap. &amp; MOSFET; certified by military-standard)</li> <li>- ASUS DIGI+ Power Control Utility</li> </ul> <p><b>“Safe &amp; Stable!” Guardian Angel</b></p> <ul style="list-style-type: none"> <li>- ESD Guards</li> <li>- MemOK!</li> <li>- Anti Surge</li> </ul>
<b>Other Special Features</b>	<p>ASUS SSD Caching          USB BIOS Flashback          USB 3.0 Boost          Front Panel USB 3.0 Support          ASUS UEFI BIOS EZ Mode featuring friendly graphics user interface          AI Suite II          ASUS Q-Connector          ASUS Q-Shield          ASUS Q-LED (CPU, DRAM, VGA, Boot Device LED)          ASUS Q-Slot          ASUS Q-DIMM          ASUS O.C. Profile          ASUS CrashFree BIOS 3          ASUS EZ Flash 2          ASUS MyLogo 2™          Multi-language BIOS</p>
<b>Back Panel I/O Ports</b>	<p>1 x PS/2 Keyboard/Mouse combo port          1 x Optical S/PDIF Output port          1 x USB BIOS Flashback Button          1 x Power eSATA 6Gb/s port (green)          1 x eSATA 6Gb/s port (red)          1 x IEEE 1394a port          1 x LAN (RJ-45) port          4 x USB 3.0/2.0 ports (blue)          6 x USB 2.0/1.1 ports          8-channel Audio I/O ports</p>

*(continued on the next page)*

# SABERTOOTH X79 specifications summary

<b>Internal I/O Connectors</b>	1 x USB 3.0/2.0 connector supports additional 2 USB 3.0/2.0 ports (19-pin; moss green) 4 x USB 2.0/1.1 connectors support additional 8 USB 2.0/1.1 ports 4 x SATA 6Gb/s connectors (2 x brown; 2 x gray) 4 x SATA 3Gb/s connectors (black) 1 x CPU Fan connector (4-pin) 1 x CPU OPT fan connector (4-pin) 4 x Chassis Fan connectors (4-pin) 1 x Assistant Fan connector (4-pin) 1 x PCH Fan connector (4-pin) 1 x Front panel audio connector (AAFP) 1 x COM connector 1 x S/PDIF Out header 1 x 24-pin EATX Power connector 1 x 8-pin EATX 12V Power connector 1 x System Panel (Q-Connector) 1 x MemOK! button 1 x Clear CMOS jumper
<b>BIOS Features</b>	64 Mb Flash ROM, UEFI BIOS, PnP, DMI 2.0, WfM 2.0, SM BIOS 2.6, ACPI 2.0a, Multi-language BIOS, ASUS EZ Flash 2, ASUS CrashFree BIOS 3
<b>Manageability</b>	WfM 2.0, DMI 2.0, WOL by PME, WOR by PME, PXE
<b>Support DVD</b>	Drivers ASUS Utilities ASUS Update Anti-virus software (OEM version)
<b>Form factor</b>	ATX form factor: 12 in. x 9.6 in. (30.5 cm x 24.4 cm)

\*Specifications are subject to change without notice.

# Chapter 1

## 1.1 Welcome!







Thank you for buying an ASUS® SABERTOOTH X79 motherboard!

The motherboard delivers a host of new features and latest technologies, making it another standout in the long line of ASUS quality motherboards!

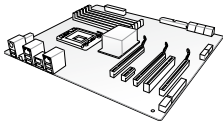
Before you start installing the motherboard, and hardware devices on it, check the items in your package with the list below.

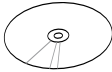
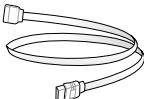
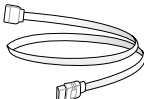
## 1.2 Package contents

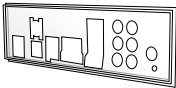
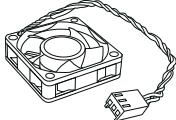
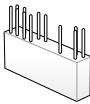
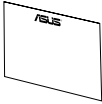
Check your motherboard package for the following items.

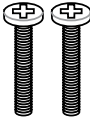
		
<b>ASUS SABERTOOTH X79 motherboard</b>	<b>User guide</b>	<b>Support DVD</b>
		
<b>4 x Serial ATA 6.0 Gb/s cables</b>	<b>2 x Serial ATA 3.0 Gb/s cables</b>	<b>1 x ASUS SLI™ bridge connector</b>
		
<b>1 x ASUS Q-Shield</b>	<b>1 x I/O Cover Fan</b>	<b>1 x 2-in-1 ASUS Q-Connector kit</b>
		
<b>1 x TUF Certification card</b>	<b>1 x TUF Five-year warranty manual (by region)</b>	<b>2 x long fan screws</b>



- If any of the above items is damaged or missing, contact your retailer.
- The illustrated items above are for reference only. Actual product specifications may vary with different models.

## 1.3 Special features

### 1.3.1 Product highlights

#### Intel® Socket 2011 for 2nd Generation Intel® Core™ i7 Process Extreme Edition

This motherboard supports the latest Intel® 2nd Generation Core™ i7 Processor Extreme in the LGA2011 package, with memory and PCI Express controllers integrated to quad-channel (8 DIMMs) DDR3 memory and 16 PCI Express 2.0 lanes. This provides great graphics performance. Intel® 2nd Generation Core™ i7 Processor Extreme is one of the most powerful and energy efficient CPUs in the world.

#### Intel® X79 Express Chipset

The Intel® X79 Express Chipset is the latest single-chipset design that supports the new socket 2011 Intel® 2nd Generation Core™ i7 Processor Extreme. It improves performance by utilizing serial point-to-point links, allowing for increased bandwidth and stability. Additionally, the X79 comes with 2 SATA 6Gb/s and 4 SATA 3Gb/s ports for faster data retrieval, doubling the bandwidth of current bus systems.

#### Quad-GPU SLI™ and Quad-GPU CrossFireX™ Support

SABERTOOTH X79 brings you the multi-GPU choice of either SLI™ or CrossFireX™. The motherboard features the most powerful Intel® X79 platform to optimize PCIe allocation in multiple GPU configurations. Expect a brand-new gaming style you've never experienced before!

#### Quad-Channel DDR3 1866/1600/1333/1066 MHz support

The motherboard supports DDR3 memory that features data transfer rates of 1866/1600/1333/1066 MHz to meet the higher bandwidth requirements of the latest operation system, 3D graphics, multimedia, and Internet applications. The quad-channel DDR3 architecture quadruple the bandwidth of your system memory to boost system performance.

\* Due to CPU behavior, DDR3 1866 MHz memory module will run at DDR3 1600 MHz frequency as default.

#### PCIe 3.0 Ready

The latest PCI Express bus standard delivers improved encoding for twice the performance of current PCIe 2.0. Total bandwidth for a x16 link reaches a maximum of 32GB/s, double the 16GB/s of PCIe 2.0 (in x16 mode). PCIe 3.0 provides users unprecedented data speeds, combined with the convenience and seamless transition offered by complete backward compatibility with PCIe 1.0 and PCIe 2.0 devices. It is a must-have feature PC users aiming to improve and optimize graphics performance, as well as have the latest, most future-proof technology.

\* This motherboard is ready to support PCIe 3.0 SPEC. Functions will be available when using PCIe 3.0-compliant devices. Please refer to [www.asus.com](http://www.asus.com) for updated details.

#### Complete USB 3.0 Integration

ASUS facilitates strategic USB 3.0 accessibility for both the front and rear panel – 6 USB 3.0 ports in total. Experience the latest plug & play connectivity at speeds up to 10 times faster than USB 2.0. The SABERTOOTH X79 affords greater convenience to high speed connectivity.

## Extra SATA 6.0 Gb/s Support

The Intel® X79 Express Chipset natively supports the next-generation Serial ATA (SATA) interface, delivering up to 6.0 Gb/s data transfer. ASUS provides extra SATA 6.0 Gb/s ports with enhanced scalability, faster data retrieval, and double the bandwidth of current bus systems.

## 1.3.2 “Ultimate COOL!” Thermal Solutions

### TUF Thermal Armor

New generation TUF Thermal Armor kicks cooling up a notch with dual integrated Turbo Engine fans. This enhances the original TUF thermal design, helping direct heat away from MOS area components and out the case via the rear I/O section. Special heat pipes propel dissipation from critical components and make sure temps stay low across the board. The Thermal Armor also provides modder’s and LAN party goers an extra-cool dress up option to show off their creativity and dedication to performance.

### TUF Thermal Radar

The TUF Thermal Radar monitors temps in critical parts of the motherboard in real time, automatically adjusting fan speeds to make sure the system maintains high stability without overheating. It consists of multiple sensors for various components on the motherboard, giving user the ability to monitor each one individually. The Thermal Radar automatically calculates ideal fan speeds based on different parameters selected by users for each component, keeping everything cooler and longer lasting.

## 1.3.3 “TUF ENGINE!” Power Design

### New DIGI+ Power Control

All-new digital CPU and DRAM power controls work perfectly together to match digital power signal (SVID) requests from the CPU, with ultra-fast sensing and response efficiently delivering precision power. Accurate delivery reduces waste, and provides more stable CPU Vcore voltages. With programmable digital controllers onboard, users can adjust CPU and DRAM PWM voltages and frequencies for various overclocking scenarios, with accurate input through UEFI BIOS tuning or the exclusive ASUS interface. This proprietary design increases overclocking headroom to push performance to its full potential.

### TUF Components (Choke, Cap. & MOSFET; certified by military-standard)

Get rugged performance even in the most challenging conditions with robust TUF chokes, solid capacitors, and MOSFETs – certified through third-party, military-grade testing. TUF chokes, also known as the “Ferrite Choke II”, is a made of compound of various types of metal instead standard iron, enables the support of up to a massive 50A of rated current, 55% higher than conventional component. Furthermore, the single piece packaging also eliminates the emission of vibration noise, delivering superb characteristics as well as durability under extreme conditions.

### 1.3.4 “Safe & Stable!” Guardian Angel

#### MemOK!

MemOK! quickly ensures memory boot compatibility. This remarkable memory rescue tool requires a mere push of a button to patch memory issues. MemOK! determines failsafe settings and dramatically improves your system boot success.

#### ESD Guards

ESD (Electrostatic Discharge) Guards provides protection against electrostatic discharges, which can damage the motherboard’s components. The ASUS exclusive Anti-Static chip and circuit design, and the I/O shield provide four times better protection and ensure the motherboard’s lifespan.

### 1.3.5 ASUS EZ DIY

#### UEFI BIOS (EZ Mode)

ASUS brand new UEFI BIOS offers a user-friendly interface that goes beyond traditional keyboard BIOS input to enable more flexible and convenient mouse controls. You can easily navigate the new UEFI BIOS with the same smoothness as their operating system. The exclusive EZ Mode displays frequently-accessed setup info, while the Advanced Mode is for experienced performance enthusiasts that demand far more intricate system settings.

#### AI Suite II

With its user-friendly interface, ASUS AI Suite II consolidates all the exclusive ASUS features into one simple to use software package. It allows you to supervise energy management, fan speed control, voltage and sensor readings. This all-in-one software offers diverse and ease to use functions, with no need to switch back and forth between different utilities.

#### ASUS Q-Design

ASUS Q-Design enhances your DIY experience. All of Q-LED, Q-Slot, and Q-DIMM design speed up and simplify the DIY process!

#### ASUS Q-Shield

ASUS Q-Shield’s special design makes it convenient and easy to install on your motherboard. With better electric conductivity, it ideally protects your motherboard against static electricity and shields it against Electronic Magnetic Interference (EMI).

#### ASUS Q-Connector

ASUS Q-Connector allows you to easily connect or disconnect the chassis front panel cables to the motherboard. This unique module eliminates the trouble of connecting the system panel cables one at a time and avoiding wrong cable connections.

#### ASUS EZ-Flash 2

ASUS EZ Flash 2 is a user-friendly utility that allows you to update the BIOS without using a bootable floppy disk or an OS-based utility.



## ASUS MyLogo2™

This feature allows you to convert your favorite photo into a 256-color boot logo for a more colorful and vivid image on your screen.

## ASUS Multi-language BIOS

The multi-language BIOS allows you to select the language of your choice from the available options. The localized BIOS setup menu helps you configure your system easier and faster.

### 1.3.6 ASUS Exclusive Features

#### ASUS SSD Caching

SSD caching from ASUS is easier than ever. At 3X faster, this feature boosts system performance by using an installed SSD with no capacity limitations as a cache for frequently accessed data. Harness a combination of SSD-like performance and response and hard drive capacity with just one click, no rebooting needed and instant activation for complete ease of use.

#### USB 3.0 Boost

New ASUS USB 3.0 Boost technology supports UASP (USB Attached SCSI Protocol), the latest USB 3.0 standard. With USB 3.0 Boost technology, the performance of a USB device transmission speed is significantly increased up to 130% (TBD), adding to an already impressive fast USB 3.0 transfer speed. With USB 3.0 Boost technology, the system provides a user-friendly graphical interface, which spontaneously accelerates the transfer speed through USB 3.0 peripherals with an ASUS exclusive auto-detect setting.

#### USB BIOS Flashback

USB BIOS Flashback offers the most convenient way to flash the BIOS ever! It allows overclockers to try new BIOS versions easily, without even entering their existing BIOS or operating system. Just plug in USB storage and push the dedicated button for 3 seconds, and the BIOS is automatically flashed using standby power. Worry-free overclocking for the ultimate convenience!

### 1.3.7 Other special features

#### Power eSATA 6Gb/ Ready

Powered eSATA 6Gb/s combines data and power connectivity. Users enjoy 2X faster transfer rates, and can use external SATA 6Gb/s devices with no additional power adapters. ASUS provides two extra ports with enhanced scalability, faster data retrieval, and double the bandwidth of current bus systems for extra speed and accessibility.

**\* Power eSATA requires a specially designed signal cable to provide 5V power for the external SATA device. The cable is purchased separately.**

## ErP Ready

The motherboard is European Union's Energy-related Products (ErP) ready, and ErP requires products to meet certain energy efficiency requirement in regards to energy consumptions. This is in line with ASUS vision of creating environment-friendly and energy-efficient products through product design and innovation to reduce carbon footprint of the product and thus mitigate environmental impacts.

## 2.1 Before you proceed

Take note of the following precautions before you install motherboard components or change any motherboard settings.



- 
- Unplug the power cord from the wall socket before touching any component.
  - Before handling components, use a grounded wrist strap or touch a safely grounded object or a metal object, such as the power supply case, to avoid damaging them due to static electricity.
  - Hold components by the edges to avoid touching the ICs on them.
  - Whenever you uninstall any component, place it on a grounded antistatic pad or in the bag that came with the component.
  - Before you install or remove any component, ensure that the ATX power supply is switched off or the power cord is detached from the power supply. Failure to do so may cause severe damage to the motherboard, peripherals, or components.
-

# 2.2 Motherboard overview

## 2.2.1 Motherboard layout

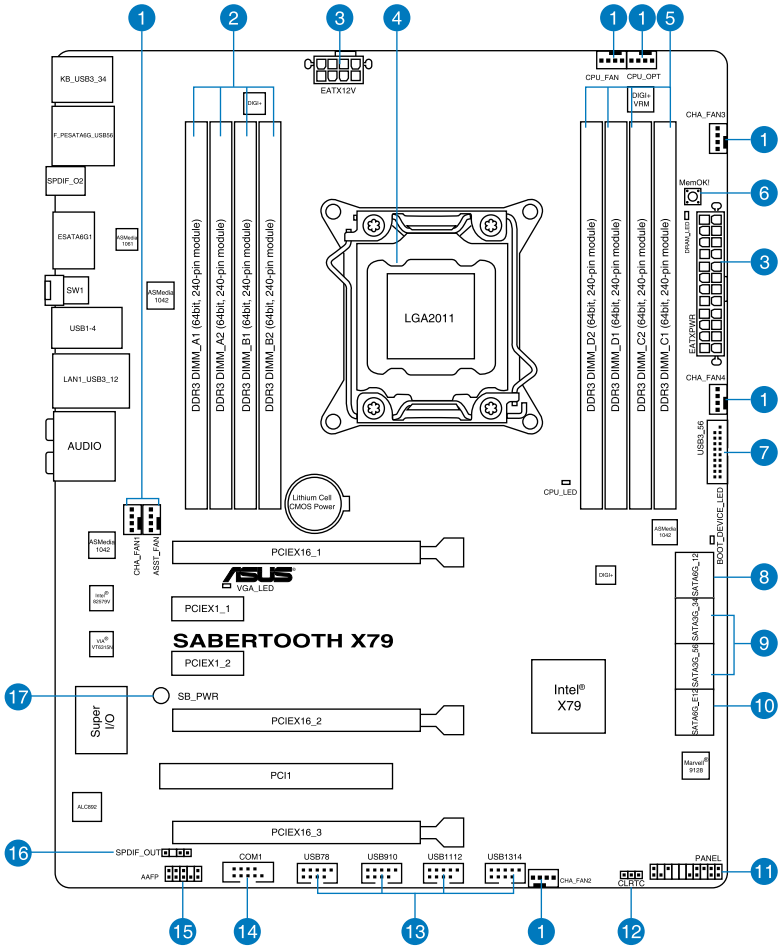

Refer to **2.2.8 Internal connectors** and **2.3.11 Rear panel connection** for more information about rear panel connectors and internal connectors.

## Layout contents

Connectors/Jumpers/Slots		Page
1.	CPU, chassis, power, and assistant fan connectors (4-pin CPU_FAN, CHA_FAN1–4, CPU_OPT, ASST_FAN)	2-22
2.	DDR3 DIMM slots channel A and B	2-5
3.	ATX power connectors (24-pin EATXPWR, 8-pin EATX12V)	2-24
4.	LGA2011 CPU socket	2-4
5.	DDR3 DIMM slots channel C and D	2-5
6.	MemOK! switch	2-15
7.	USB 3.0 connector (20-1 pin USB3_56)	2-20
8.	Intel® X79 Serial ATA 6Gb/s connectors (7-pin SATA6G_1/2 [brown])	2-17
9.	Intel® X79 Serial ATA 3Gb/s connectors (7-pin SATA3G_3–6 [black])	2-18
10.	Marvell® Serial ATA 6Gb/s connectors (7-pin SATA6G_E1/E2 [gray])	2-19
11.	System panel connector (20-8 pin PANEL)	2-25
12.	Clear RTC RAM (3-pin CLRTC)	2-14
13.	USB 2.0 connectors (10-1 pin USB78, USB910, USB1112, USB1314)	2-21
14.	Serial port connector (10-1 pin COM1)	2-20
15.	Front panel audio connector (10-1 pin AAFP)	2-23
16.	Digital audio connector (4-1 pin SPDIF_OUT)	2-21
17.	Standby power LED (SB_PWR)	2-16

## 2.2.2 Central Processing Unit (CPU)

The motherboard comes with a surface mount LGA2011 socket designed for the Intel® Core™ i7 Processor Extreme Edition.

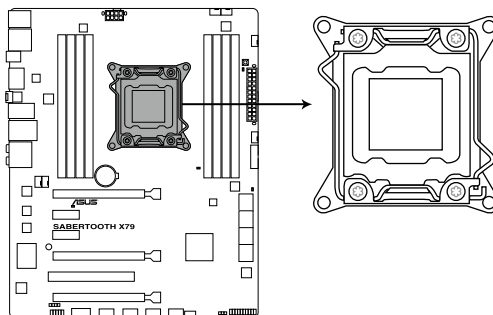

**SABERTOOTH X79 CPU LGA2011**



---

Ensure that all power cables are unplugged before installing the CPU.

---



- Upon purchase of the motherboard, ensure that the PnP cap is on the socket and the socket contacts are not bent. Contact your retailer immediately if the PnP cap is missing, or if you see any damage to the PnP cap/socket contacts/motherboard components. ASUS will shoulder the cost of repair only if the damage is shipment/transit-related.
  - Keep the cap after installing the motherboard. ASUS will process Return Merchandise Authorization (RMA) requests only if the motherboard comes with the cap on the LGA2011 socket.
  - The product warranty does not cover damage to the socket contacts resulting from incorrect CPU installation/removal, or misplacement/loss/incorrect removal of the PnP cap.
-

## 2.2.3 System memory

The motherboard comes with eight Double Data Rate 3 (DDR3) Dual Inline Memory Modules (DIMM) slots.



A DDR3 module is notched differently from a DDR or DDR2 module. DO NOT install a DDR or DDR2 memory module to the DDR3 slot.

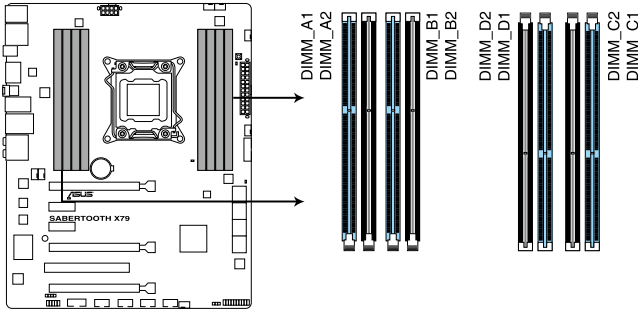

SABERTOOTH X79 240-pin DDR3 DIMM socket

### Recommended memory configurations

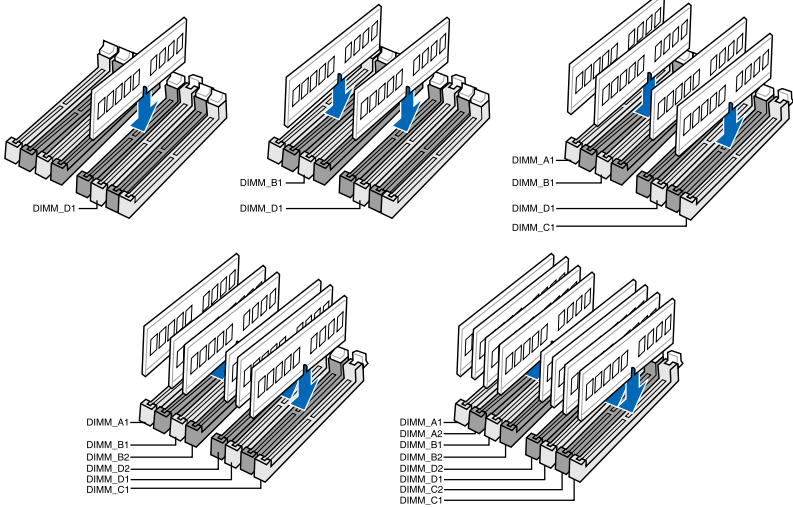

## Memory configurations

You may install 1GB, 2GB, 4GB and 8GB unbuffered and non-ECC DDR3 DIMMs into the DIMM sockets.



- 
- You may install varying memory sizes in Channel A, Channel B, Channel C and Channel D. The system maps the total size of the lower-sized channel for the quad-channel configuration. Any excess memory from the higher-sized channel is then mapped for single-channel operation.
  - Due to CPU behavior, DDR3 1800 MHz memory module will run at DDR3 1600 MHz frequency as default.
  - The Max. 64GB memory capacity can be supported with DIMMs of 8GB (or above). ASUS will update QVL once the DIMMs are available on the market.
  - According to Intel CPU spec, DIMM voltage below 1.65V is recommended to protect the CPU.
  - Always install DIMMs with the same CAS latency. For optimum compatibility, we recommend that you obtain memory modules from the same vendor.
  - Due to the memory address limitation on 32-bit Windows OS, when you install 4GB or more memory on the motherboard, the actual usable memory for the OS can be about 3GB or less. For effective use of memory, we recommend that you do any of the following:
    - Use a maximum of 3GB system memory if you are using a 32-bit Windows OS.
    - Install a 64-bit Windows OS when you want to install 4GB or more on the motherboard.For more details, refer to the Microsoft® support site at <http://support.microsoft.com/kb/929605/en-us>.
  - This motherboard does not support DIMMs made up of 512Mb (64MB) chips or less (Memory chip capacity counts in Megabit, 8 Megabit/Mb = 1 Megabyte/MB).
- 



- The default memory operation frequency is dependent on its Serial Presence Detect (SPD), which is the standard way of accessing information from a memory module. Under the default state, some memory modules for overclocking may operate at a lower frequency than the vendor-marked value. To operate at the vendor-marked or at a higher frequency, refer to section **3.4 Ai Tweaker menu** for manual memory frequency adjustment.
  - For system stability, use a more efficient memory cooling system to support a full memory load (4 DIMMs) or overclocking condition.
-



# SABERTOOTH X79 Motherboard Qualified Vendors Lists (QVL)

## DDR3 1333 MHz capability

Vendors	Part No.	Size	SS/ DS	Chip Brand	Chip NO.	Timing	Voltage	DIMM socket support (Optional)			
								2 DIMM	4 DIMM	6 DIMM	8 DIMM
A-DATA	AD6311B0823EV	2GB	SS	A-DATA	3CCA-1509A	-	-	*	*	*	*
A-DATA	AM2U139C2P1	2GB	SS	A-DATA	3CCD-1509A	-	-	*	*	*	*
A-DATA	AXDU1333GC2G9(XMP)	2GB	SS	-	-	9-9-9-24	1.25-1.35	*	*	*	*
A-DATA	AD6311C1624E2	4GB	DS	A-DATA	3CCA-1509A	-	-	*	*	*	*
A-DATA	AM2U139C4P2	4GB	DS	A-DATA	3CCD-1509A	-	-	*	*	*	*
A-DATA	SU3U1333W8G9(XMP)	8GB	DS	ELPIDA	J4208BASE-DJ-F	-	-	*	*	*	*
Apacer	78.01GC6.9L0	1GB	SS	Apacer	AM5D5808DEJSBG	9	-	*	*	*	*
Apacer	78.A1GC6.9L1	2GB	DS	Apacer	AM5D5808FEQSBG	9	-	*	*	*	*
Apacer	78.B1GDE.9L10C	4GB	DS	Apacer	AM5D5908CEHSBG	9	-	*	*	*	*
CORSAIR	TW3X4G1333C9A	4GB(2x2GB)	DS	-	-	9-9-9-24	1.5	*	*	*	*
CORSAIR	CMX8GX3M2A1333C9(XMP)	8GB(2x4GB)	DS	-	-	9-9-9-24	1.5	*	*	*	*
CORSAIR	CMX8GX3M4A1333C9	8GB(4x2GB)	DS	-	-	9-9-9-24	1.5	*	*	*	*
Crucial	BL25664BN1337.16FF(XMP)	2GB	DS	-	-	7-7-7-24	1.65	*	*	*	*
ELPIDA	EBJ10UE8BDF0-DJ-F	1GB	SS	ELPIDA	J1108BDSE-DJ-F	-	-	*	*	*	*
ELPIDA	EBJ10UE8EDF0-DJ-F	1GB	SS	ELPIDA	J1108EJSE-DJ-F	-	-	*	*	*	*
ELPIDA	EBJ20UF8BCF0-DJ-F	2GB	SS	Elpida	J2108BCSE-DJ-F	-	-	*	*	*	*
ELPIDA	EBJ21UE8BDF0-DJ-F	2GB	SS	ELPIDA	J1108BDSE-DJ-F	-	-	*	*	*	*
G.SKILL	F3-10600CL9D-4GBNT	4GB(2x2GB)	DS	G.SKILL	D3 128M6CE9 2GB	9-9-9-24	1.5	*	*	*	*
G.SKILL	F3-10666CL8D-4GBHK(XMP)	4GB(2x2GB)	DS	-	-	8-8-8-21	1.5	*	*	*	*
G.SKILL	F3-10666CL7D-4GBRH(XMP)	4GB(2x2GB)	DS	-	-	7-7-7-21	1.5	*	*	*	*
G.SKILL	F3-10666CL8D-4GBECO(XMP)	4GB(2x2GB)	DS	-	-	8-8-8-24	1.35	*	*	*	*
G.SKILL	F3-10666CL9D-8GBRLL	8GB(2x4GB)	DS	-	-	9-9-9-24	1.5	*	*	*	*
G.SKILL	F3-10666CL9D-8GBRL	8GB(2x4GB)	DS	-	-	9-9-9-24	1.5	*	*	*	*
G.SKILL	F3-10666CL9D-8GBXL	8GB(2x4GB)	DS	-	-	9-9-9-24	1.5	*	*	*	*
GEIL	GVP34GB1333C9DC	4GB(2x2GB)	DS	-	-	9-9-9-24	1.5	*	*	*	*
GEIL	GET316GB1333C9QC	16GB(4x4GB)	DS	-	-	9-9-9-24	1.5	*	*	*	*
GEIL	GG34GB1333C9DC	4GB(2x2GB)	DS	GEIL	GL1L128M88BA115FW	9-9-9-24	1.3	*	*	*	*
GEIL	GG34GB1333C9DC	4GB(2x2GB)	DS	GEIL	GL1L128M88BA15B	9-9-9-24	1.3	*	*	*	*
GEIL	GB34GB1333C7DC	4GB(2x2GB)	DS	GEIL	GL1L128M88BA15FW	7-7-7-24	1.5	*	*	*	*
GEIL	GG34GB1333C9DC	4GB(2x2GB)	DS	GEIL	GL1L128M88BA12N	9-9-9-24	1.3	*	*	*	*
GEIL	GVP38GB1333C9DC	8GB(2x4GB)	DS	-	-	9-9-9-24	1.5	*	*	*	*
Hynix	HMT112U6TFR8A-H9	1GB	SS	Hynix	H5TC1G83TFR	-	-	*	*	*	*
Hynix	HMT325U6BFR8C-H9	2GB	SS	Hynix	H5TQ2G83BFR	-	-	*	*	*	*
Hynix	HMT125U6BFR8C-H9	2GB	DS	Hynix	H5TQ1G83BFRH9C	9	-	*	*	*	*
Hynix	HMT125U6TFR8A-H9	2GB	DS	Hynix	H5TC1G83TFR	-	-	*	*	*	*
Hynix	HMT351U6BFR8C-H9	4GB	DS	Hynix	H5TQ2G83BFR	-	-	*	*	*	*
KINGMAX	FLFE85F-C8KL9	2GB	SS	KINGMAX	KFC8FNLXF-DXX-15A	-	-	*	*	*	*
KINGMAX	FLFE85F-C8KM9	2GB	SS	Kingmax	KFC8FNMXF-BXX-15A	-	-	*	*	*	*
KINGMAX	FLFE85F-B8KL9	2GB	DS	KINGMAX	KFB8FNLXL-BNF-15A	-	-	*	*	*	*
KINGMAX	FLFF65F-C8KL9	4GB	DS	KINGMAX	KFC8FNLXF-DXX-15A	-	-	*	*	*	*
KINGMAX	FLFF65F-C8KM9	4GB	DS	Kingmax	KFC8FNMXF-BXX-15A	-	-	*	*	*	*
KINGSTON	KVR1333D3N9/1G	1GB	SS	Elpida	J1108BDSE-DJ-F	9	1.5	*	*	*	*
KINGSTON	KVR1333D3S8N9/2G	2GB	SS	Micron	IFD77 D9L GK	-	1.5	*	*	*	*
KINGSTON	KVR1333D3N9/2G	2GB	DS	Kingston	D1288JPNPLD9U	9	1.5	*	*	*	*
KINGSTON	KVR1333D3N9K2/4G	4GB(2x2GB)	DS	KINGSTON	D1288JEMFPGD9U	-	1.5	*	*	*	*
KINGSTON	KVR1333D3E9S/4G	4GB	DS	Elpida	J2108ECSE-DJ-F	9	1.5	*	*	*	*
MICRON	MT4JTF12864AZ-1G4D1	1GB	SS	Micron	D9L GK	-	-	*	*	*	*
MICRON	MT8JTF25664AZ-1G4D1	2GB	SS	Micron	D9L GK	-	-	*	*	*	*
MICRON	MT8JTF25664AZ-1G4D1	2GB	SS	Micron	D9L GK	-	-	*	*	*	*
MICRON	MT8JTF25664AZ-1G4M1	2GB	SS	MICRON	D9PFJ	-	-	*	*	*	*
MICRON	MT16JTF51264AZ-1G4D1	4GB	DS	Micron	D9L GK	-	-	*	*	*	*
MICRON	MT16JTF51264AZ-1G4M1	4GB	DS	Micron	IGM22 D9PFJ	-	-	*	*	*	*
NANYA	NT4GC64B8HGONF-CG	4GB	DS	NANYA	NT5CB256M8GN-CG	-	-	*	*	*	*
OCZ	OCZ3P1333LV3GK	3GB(3x1GB)	SS	-	-	7-7-7	1.65	*	*	*	*
OCZ	OCZ3G1333LV4GK	4GB(2x2GB)	DS	-	-	9-9-9	1.65	*	*	*	*
OCZ	OCZ3P1333LV4GK	4GB(2x2GB)	DS	-	-	7-7-7	1.65	*	*	*	*
OCZ	OCZ3G1333LV8GK	8GB(2x4GB)	DS	-	-	9-9-9	1.65	*	*	*	*

## SABERTOOTH X79 Motherboard Qualified Vendors Lists (QVL) DDR3 1333 MHz capability (continued)

Vendors	Part No.	Size	SS/ DS	Chip Brand	Chip NO.	Timing	Voltage	DIMM socket support (Optional)			
								2 DIMM	4 DIMM	6 DIMM	8 DIMM
OCZ	OCZ3G1333LV8GK	8GB(2x4GB)	DS	-	-	9-9-9	1.65	*	*	*	*
OCZ	OCZ3RPR1333C9LV8GK	8GB(2x4GB)	DS	-	-	9-9-9	1.65	*	*	*	*
PSC	PC310600U-9-10-A0	1GB	SS	PSC	A3P1GF3FGF	-	-	*	*	*	*
PSC	PC310600U-9-10-B0	2GB	SS	PSC	A3P1GF3FGF	-	-	*	*	*	*
SAMSUNG	M378B2873EH1-CH9	1GB	SS	SAMSUNG	K4B1G0846E	-	-	*	*	*	*
SAMSUNG	M378B2873FHS-CH9	1GB	SS	SAMSUNG	K4B1G0846F	-	-	*	*	*	*
SAMSUNG	M378B5773DH0-CH9	2GB	SS	Samsung	K4B2G08460	-	-	*	*	*	*
SAMSUNG	M378B5673FH0-CH9	2GB	DS	SAMSUNG	K4B1G0846F	-	-	*	*	*	*
SAMSUNG	M378B5273BH1-CH9	4GB	DS	SAMSUNG	K4B2G0846B-HCH9	9	-	*	*	*	*
SAMSUNG	M378B5273CH0-CH9	4GB	DS	SAMSUNG	K4B2G0846C	-	-	*	*	*	*
SAMSUNG	M378B5273DH0-CH9	4GB	DS	Samsung	K4B2G08460	-	-	*	*	*	*
SAMSUNG	M378B1G73AH0-CH9	8GB	DS	SAMSUNG	K4B4G0846A-HCH9	-	-	*	*	*	*
Transcend	TS256MLK64V3N(585541)	2GB	SS	Micron	ICD77 D9LKG	9	-	*	*	*	*
Transcend	TS256MLK64V3N(566577)	2GB	SS	Hynix	H5TQ2G83BFR	9	-	*	*	*	*
Transcend	TS256MLK64V3N(574206)	2GB	SS	Micron	D9LKG	9	-	*	*	*	*
Transcend	JM1333KLU-2G(584076)	2GB	DS	Micron	IBG22 D9MNL	9	-	*	*	*	*
Transcend	JM1333KLN-4G(583782)	4GB	DS	Transcend	TK483PCW3	9	-	*	*	*	*
Transcend	TS512MLK64V3N(585538)	4GB	DS	Micron	IED27 D9LKG	9	-	*	*	*	*
Transcend	TS512MLK64V3N(389889)	4GB	DS	Hynix	H5TQ2G83BFR	9	-	*	*	*	*
Transcend	TS512MLK64V3N(574831)	4GB	DS	Micron	D9LKG	9	-	*	*	*	*
ACTICA	ACT1GHU64B9F1333S	1GB	SS	Samsung	K4B1G0846F	-	-	*	*	*	*
ACTICA	ACT1GHU72C8G1333S	1GB	SS	Samsung	K4B1G0846F(ECC)	-	-	*	*	*	*
ACTICA	ACT2GHU64B8G1333M	2GB	DS	Micron	D9KPT	-	-	*	*	*	*
ACTICA	ACT2GHU64B9G1333S	2GB	DS	Samsung	K4B1G0846F	-	-	*	*	*	*
ACTICA	ACT2GHU72D8G1333M	2GB	DS	Micron	D9KPT(ECC)	-	-	*	*	*	*
ACTICA	ACT2GHU72D8G1333S	2GB	DS	Samsung	K4B1G0846F(ECC)	-	-	*	*	*	*
ACTICA	ACT4GHU64B8H1333H	4GB	DS	Hynix	H5TQ2G83AFR	-	-	*	*	*	*
ACTICA	ACT4GHU72D8H1333H	4GB	DS	Hynix	H5TQ2G83AFR(ECC)	-	-	*	*	*	*
ATP	AQ56M72ERBJH9S	2GB	DS	SAMSUNG	K4B1G0846F(ECC)	-	-	*	*	*	*
ATP	AQ12M72ERBKHS	4GB	DS	SAMSUNG	K4B2G0846C(ECC)	-	-	*	*	*	*
BUFFALO	D3U1333-1G	1GB	SS	Elpida	J1108BFBG-DJ-F	-	-	*	*	*	*
BUFFALO	D3U1333-2G	2GB	DS	Elpida	J1108BFBG-DJ-F	-	-	*	*	*	*
BUFFALO	D3U1333-4G	4GB	DS	NANYA	NT5CB256M8BN-CG	-	-	*	*	*	*
EK Memory	EKM324L288P8-113	4GB(2x2GB)	DS	-	-	9	-	*	*	*	*
Elixir	M2F2G64CB88B7N-CG	2GB	SS	Elixir	N2CB2G808N-CG	-	-	*	*	*	*
Elixir	M2F2G64CB88D7N-CG	2GB	SS	Elixir	M2CB2G8BDN-CG	-	-	*	*	*	*
Elixir	M2F4G64CB88HB5N-CG	4GB	DS	Elixir	N2CB2G808N-CG	-	-	*	*	*	*
Elixir	M2F4G64CB88HD5N-CG	4GB	DS	Elixir	M2CB2G8BDN-CG	-	-	*	*	*	*
GoodRam	GRI1333D364L9/2G	2GB	DS	Qimonda	IDSH1G-03A1F1C-13H	-	-	*	*	*	*
KINGTIGER	F10DA2T1680	2GB	DS	KINGTIGER	KTG1333P51208NST-C9	-	-	*	*	*	*
KINGTIGER	KTG2G1333PG3	2GB	DS	-	-	-	-	*	*	*	*
Patriot	PGS34G1333LLKA	4GB(2x2GB)	DS	-	-	7-7-7-20	1.7	*	*	*	*
Patriot	PVS34G1333ELK	4GB(2x2GB)	DS	-	-	9-9-9-24	1.5	*	*	*	*
Patriot	PVS34G1333LLK	4GB(2x2GB)	DS	-	-	7-7-7-20	1.7	*	*	*	*
RiDATA	C304627CB1AG22Fe	2GB	DS	RiDATA	C304627CB1AG22Fe	9	-	*	*	*	*
RiDATA	E304459CB1AG32Cf	4GB	DS	RiDATA	E304459CB1AG32Cf	9	-	*	*	*	*
Silicon Power	SP001GBLTE133S01	1GB	SS	NANYA	NT5CB128M8AN-CG	-	-	*	*	*	*
Silicon Power	SP001GBLTU133S01	1GB	SS	NANYA	NT5CB128M8AN-CG	-	-	*	*	*	*
Silicon Power	SP001GBLTU133S02	1GB	SS	S-POWER	10YT3E5	9	-	*	*	*	*
Silicon Power	SP002GBLTE133S01	2GB	DS	NANYA	NT5CB128M8AN-CG	-	-	*	*	*	*
Silicon Power	SP002GBLTU133S02	2GB	DS	S-POWER	10YT3E0	9	-	*	*	*	*
Team	TXD31024M1333C7(XMP)	1GB	SS	Team	T3D1288LT-13	7-7-7-21	1.75	*	*	*	*
Team	TXD31048M1333C7-D(XMP)	1GB	SS	Team	T3D1288LT-13	7-7-7-21	1.75	*	*	*	*
Team	TXD32048M1333C7-D(XMP)	2GB	DS	Team	T3D1288LT-13	7-7-7-21	1.5-1.6	*	*	*	*
Team	TXD32048M1333C7-D(XMP)	2GB	DS	Team	T3D1288LT-13	7-7-7-21	1.5-1.6	*	*	*	*

## SABERTOOTH X79 Motherboard Qualified Vendors Lists (QVL) DDR3 1600 MHz capability

Vendors	Part No.	Size	SS/ DS	Chip Brand	Chip NO.	Timing	Voltage	DIMM socket support (Optional)			
								2 DIMM	4 DIMM	6 DIMM	8 DIMM
A-DATA	AX3U1600XC2G79(XMP)	2GB	SS	-	-	9-9-9-24	1.6-1.8	*	*	*	*
A-DATA	AX3U1600GC4G9(XMP)	4GB	DS	-	-	-	1.55-1.75	*	*	*	*
A-DATA	AX3U1600PC4G8(XMP)	4GB	DS	-	-	8-8-8-24	1.55-1.75	*	*	*	*
A-DATA	AX3U1600XC4G79(XMP)	4GB	DS	-	-	7-9-7-21	1.65	*	*	*	*
CORSAIR	HX3X12G1600C9(XMP)	12GB(6x2GB)	DS	-	-	9-9-9-24	1.6	*	*	*	*
CORSAIR	CMZ16GX3M4A1600C9(XMP)	16GB(4x4GB)	DS	-	-	9-9-9-24	1.5	*	*	*	*
CORSAIR	CMG4GX3M2A1600C6	4GB(2x2GB)	DS	-	-	6-6-6-18	1.65	*	*	*	*
CORSAIR	CMZ4GX3M2B1600C8	4GB(2x2GB)	DS	-	-	8-8-8-24	1.65	*	*	*	*
CORSAIR	CMG4GX3M2A1600C6	4GB(2x2GB)	DS	-	-	6-6-6-18	1.65	*	*	*	*
CORSAIR	CMX4GX3M2A1600C8(XMP)	4GB(2x2GB)	DS	-	-	8-8-8-24	1.65	*	*	*	*
CORSAIR	CMG4GX3M2A1600C7(XMP)	4GB(2x2GB)	DS	-	-	7-7-7-20	1.65	*	*	*	*
CORSAIR	CMP6GX3M3A1600C8(XMP)	6GB(3x2GB)	DS	-	-	8-8-8-24	1.65	*	*	*	*
CORSAIR	CMP6GX3M3A1600C8(XMP)	6GB(3x2GB)	DS	-	-	8-8-8-24	1.65	*	*	*	*
CORSAIR	CMX6GX3M3C1600C7(XMP)	6GB(3x2GB)	DS	-	-	7-8-7-20	1.65	*	*	*	*
CORSAIR	TR3X6G1600C8D(XMP)	6GB(3x2GB)	DS	-	-	8-8-8-24	1.65	*	*	*	*
CORSAIR	CMP8GX3M2A1600C9(XMP)	8GB(2x4GB)	DS	-	-	9-9-9-24	1.65	*	*	*	*
CORSAIR	CMZ8GX3M2A1600C8(XMP)	8GB(2x4GB)	DS	-	-	8-8-8-24	1.5	*	*	*	*
CORSAIR	CMZ8GX3M2A1600C9(XMP)	8GB(2x4GB)	DS	-	-	9-9-9-24	1.5	*	*	*	*
Crucial	BL12864BN1608.8FF(XMP)	2GB(2x1GB)	SS	-	-	8-8-8-24	1.65	*	*	*	*
Crucial	BL25664BN1608.16FF(XMP)	2GB	DS	-	-	8-8-8-24	1.65	*	*	*	*
G.SKILL	F3-12800CL9Q-16GBXL(XMP)	16GB(4x4GB)	DS	-	-	9-9-9-24	1.5	*	*	*	*
G.SKILL	F3-12800CL9D-4GBN(XMP)	4GB(2x2GB)	DS	-	-	9-9-9-24	1.5	*	*	*	*
G.SKILL	F3-12800CL8D-4GBRM(XMP)	4GB(2x2GB)	DS	-	-	8-8-8-24	1.6	*	*	*	*
G.SKILL	F3-12800CL9D-4GBECO(XMP)	4GB(2x2GB)	DS	-	-	9-9-9-24	1.35	*	*	*	*
G.SKILL	F3-12800CL7D-8GBXH(XMP)	8GB(2x4GB)	DS	-	-	7-8-7-24	1.6	*	*	*	*
G.SKILL	F3-12800CL9D-8GBRL(XMP)	8GB(2x4GB)	DS	-	-	9-9-9-24	1.5	*	*	*	*
G.SKILL	F3-12800CL9D-8GBSR2(XMP)	8GB(2x4GB)	DS	-	-	9-9-9-24	1.25	*	*	*	*
G.SKILL	F3-12800CL8D-8GBECO(XMP)	8GB(2x4GB)	DS	-	-	8-8-8-24	1.35	*	*	*	*
GEIL	GET316GB1600C9QC(XMP)	16GB(4x4GB)	DS	-	-	9-9-9-28	1.6	*	*	*	*
GEIL	GUP34GB1600C7DC(XMP)	4GB(2x2GB)	DS	-	-	7-7-7-24	1.6	*	*	*	*
GEIL	GVP38GB1600C8QC(XMP)	8GB(4x2GB)	DS	-	-	8-8-8-28	1.6	*	*	*	*
KINGMAX	FLGD45F-B8MF7(XMP)	1GB	SS	-	-	-	-	*	*	*	*
KINGSTON	KHX1600C9D3K3/12GX(XMP)	12GB(3x4GB)	DS	-	-	9	1.65	*	*	*	*
KINGSTON	KHX1600C9D3T1BK3/12GX(XMP)	12GB(3x4GB)	DS	-	-	9	1.65	*	*	*	*
KINGSTON	KHX1600C9D3K3/12GX(XMP)	12GB(3x4GB)	DS	-	-	-	1.65	*	*	*	*
KINGSTON	KHX1600C9D3K6/24GX(XMP)	24GB(6x4GB)	DS	-	-	9	1.65	*	*	*	*
KINGSTON	KHX1600C7D3K2/4GX(XMP)	4GB(2x2GB)	DS	-	-	-	1.65	*	*	*	*
KINGSTON	KHX1600C8D3K2/4GX(XMP)	4GB(2x2GB)	DS	-	-	8	1.65	*	*	*	*
KINGSTON	KHX1600C9D3B1K2/4GX(XMP)	4GB(2x2GB)	DS	-	-	9-9-9-24	1.65	*	*	*	*
KINGSTON	KHX1600C9D3K2/4GX(XMP)	4GB(2x2GB)	DS	-	-	-	1.65	*	*	*	*
KINGSTON	KHX1600C9D3K2/4GX(XMP)	4GB(2x2GB)	DS	-	-	-	1.65	*	*	*	*
KINGSTON	KHX1600C9D3K2/4GX(XMP)	4GB(2x2GB)	DS	-	-	-	1.65	*	*	*	*
KINGSTON	KHX1600C9D3K3/6GX(XMP)	6GB(3x2GB)	DS	-	-	9	1.65	*	*	*	*
KINGSTON	KHX1600C9D3K3/6GX(XMP)	6GB(3x2GB)	DS	-	-	9	1.65	*	*	*	*
KINGSTON	KHX1600C9D3T1BK3/6GX(XMP)	6GB(3x2GB)	DS	-	-	9	1.65	*	*	*	*
KINGSTON	KHX1600C9D3T1K3/6GX(XMP)	6GB(3x2GB)	DS	-	-	-	1.65	*	*	*	*
KINGSTON	KHX1600C9D3T1K3/6GX(XMP)	6GB(3x2GB)	DS	-	-	9	1.65	*	*	*	*
OCZ	OCZ3BE1600C8LV4GK	4GB(2x2GB)	DS	-	-	8-8-8	1.65	*	*	*	*
OCZ	OCZ3X1600LV4GK(XMP)	4GB(2x2GB)	DS	-	-	8-8-8	1.65	*	*	*	*
OCZ	OCZ3G1600LV6GK	6GB(3x2GB)	DS	-	-	8-8-8	1.65	*	*	*	*
OCZ	OCZ3X1600LV6GK(XMP)	6GB(3x2GB)	DS	-	-	8-8-8	1.65	*	*	*	*
OCZ	OCZ3X1600LV6GK(XMP)	6GB(3x2GB)	DS	-	-	8-8-8	1.65	*	*	*	*
Super Talent	WP160UX4G9(XMP)	4GB(2x2GB)	DS	-	-	9	-	*	*	*	*
Super Talent	WB160UX6G8(XMP)	6GB(3x2GB)	DS	-	-	-	-	*	*	*	*
Super Talent	WB160UX6G8(XMP)	6GB(3x2GB)	DS	-	-	8	-	*	*	*	*
Asint	SLZ3128M8-EGJ1D(XMP)	2GB	DS	Asint	3128M8-GJ1D	-	-	*	*	*	*

## SABERTOOTH X79 Motherboard Qualified Vendors Lists (QVL) DDR3 1600 MHz capability (continued)

Vendors	Part No.	Size	SS/ DS	Chip Brand	Chip NO.	Timing	Voltage	DIMM socket support (Optional)			
								2 DIMM	4 DIMM	6 DIMM	8 DIMM
EK Memory	EKM324L28BP8-116(XMP)	4GB(2x2GB)	DS	-	-	9	-	*	*	*	*
EK Memory	EKM324L28BP8-116(XMP)	4GB(2x2GB)	DS	-	-	9	-	*	*	*	*
GoodRam	GR1600D364L9/2G	2GB	DS	GoodRam	GF1008KC-JN	-	-	*	*	*	*
KINGTIGER	KTG2G1600PG3(XMP)	2GB	DS	-	-	-	-	*	*	*	*
Mushkin	996805(XMP)	4GB(2x2GB)	DS	-	-	6-8-6-24	1.65	*	*	*	*
Mushkin	998805(XMP)	6GB(3x2GB)	DS	-	-	6-8-6-24	1.65	*	*	*	*
Patriot	PX7312G1600LLK(XMP)	12GB(3x4GB)	DS	-	-	8-9-8-24	1.65	*	*	*	*
Patriot	PGS34G1600LLKA2	4GB(2x2GB)	DS	-	-	8-8-8-24	1.7	*	*	*	*
Patriot	PGS34G1600LLKA	4GB(2x2GB)	DS	-	-	7-7-7-20	1.7	*	*	*	*
PATRIOT	PGS34G1600LLKA	4GB(2x2GB)	DS	-	-	7-7-7-20	1.7	*	*	*	*
Patriot	PVT36G1600LLK(XMP)	6GB(3x2GB)	DS	-	-	8-8-8-24	1.65	*	*	*	*
Patriot	PX538G1600LLK(XMP)	8GB(2x4GB)	DS	-	-	8-9-8-24	1.65	*	*	*	*
Team	TXD31024M1600C8-D(XMP)	1GB	SS	Team	T3D1288RT-16	8-8-8-24	1.65	*	*	*	*
Team	TXD32048M1600HC8-D(XMP)	2GB	DS	Team	T3D1288RT-16	8-8-8-24	1.65	*	*	*	*

## SABERTOOTH X79 Motherboard Qualified Vendors Lists (QVL) DDR3 1600 MHz capability\*

Vendors	Part No.	Size	SS/ DS	Chip Brand	Chip NO.	Timing	Voltage	DIMM socket support (Optional)			
								2 DIMM	4 DIMM	6 DIMM	8 DIMM
G.SKILL	F3-14400CL9D-4GBRL(XMP)	4GB(2x2GB)	DS	-	-	9-9-9-24	1.6	*	*	*	*
KINGSTON	KHX1800C9D3T1K3/6GX(XMP)	6GB(3x2GB)	DS	-	-	-	1.65	*	*	*	*

\* The above QVL is for the DDR3 1800 MHz memory module. Due to CPU behavior, DDR3 1800 MHz memory module will run at DDR3 1600 MHz frequency.

## SABERTOOTH X79 Motherboard Qualified Vendors Lists (QVL) DDR3 1866 MHz capability

Vendors	Part No.	Size	SS/ DS	Chip Brand	Chip NO.	Timing	Voltage	DIMM socket support (Optional)			
								2 DIMM	4 DIMM	6 DIMM	8 DIMM
A-DATA	AX3U1866GC4G9B(XMP)	4GB	DS	-	-	9-11-9-27	1.55~1.75	*	*	*	*
CORSAIR	CMZ8GX3M2A1866C9(XMP)	8GB(2x4GB)	DS	-	-	9-10-9-27	1.5	*	*	*	*
G.SKILL	F3-14900CL9Q-16GBXL(XMP)	16GB(4x4GB)	DS	-	-	9-10-9-28	1.5	*	*	*	*
G.SKILL	F3-15000CL9D-4GBTD(XMP)	4GB(2x2GB)	DS	-	-	9-9-9-24	1.65	*	*	*	*
G.SKILL	F3-14900CL9D-8GBSR(XMP)	8GB(2x4GB)	DS	-	-	9-10-9-28	1.5	*	*	*	*
G.SKILL	F3-14900CL9Q-8GBFLD(XMP)	8GB(2x4GB)	DS	-	-	9-9-9-24	1.6	*	*	*	*
KINGSTON	KHX1866C9D3T1K3/3GX(XMP)	3GB(3x1GB)	SS	-	-	-	1.65	*	*	*	*
OCZ	OCZ3G1866LV4GK	4GB(2x2GB)	DS	-	-	10-10-10	1.65	*	*	*	*
OCZ	OCZ3RPR1866C9LV6GK	6GB(3x2GB)	DS	-	-	9-9-9	1.65	*	*	*	*
Super Talent	W1866UX2G8(XMP)	2GB(2x1GB)	SS	-	-	8-8-8-24	-	*	*	*	*
Team	TXD32048M1866C9(XMP)	2GB	DS	Team	T3D1288RT-16	9-9-9-24	1.65	*	*	*	*

## SABERTOOTH X79 Motherboard Qualified Vendors Lists (QVL) DDR3 1866 MHz capability\*

Vendors	Part No.	Size	SS/ DS	Chip Brand	Chip NO.	Timing	Voltage	DIMM socket support (Optional)			
								2 DIMM	4 DIMM	6 DIMM	8 DIMM
A-DATA	AX3U2000GC4G9B(XMP)	4GB	DS	-	-	9-11-9-27	1.55~1.75	*	*	*	*
Apacer	78.AAGD5.9KD(XMP)	6GB(3x2GB)	DS	-	-	9-9-9-27	-	*	*	*	*
CORSAIR	CMT6GX3M3A2000C8(XMP)	6GB(3x2GB)	DS	-	-	8-9-8-24	1.65	*	*	*	*
G.SKILL	F3-16000CL9D-4GBTD(XMP)	4GB(2x2GB)	DS	-	-	9-9-9-24	1.65	*	*	*	*
G.SKILL	F3-16000CL9T-6GBPS(XMP)	6GB(3x2GB)	DS	-	-	9-9-9-24	1.65	*	*	*	*
GEIL	GUP34GB2000C9DC(XMP)	4GB(2x2GB)	DS	-	-	9-9-9-28	1.65	*	*	*	*
KINGSTON	KHX2000C9AD3T1K3/3GX(XMP)	3GB(3x1GB)	SS	-	-	-	1.65	*	*	*	*
KINGSTON	KHX2000C9AD3T1K2/4GX(XMP)	4GB(2x2GB)	DS	-	-	9	1.65	*	*	*	*
OCZ	OCZB2000LV6GK	6GB(3x2GB)	DS	-	-	7-8-7	1.65	*	*	*	*
Transcend	TX2000KLN-8GK (388375)(XMP)	4GB	DS	-	-	-	1.6	*	*	*	*

## SABERTOOTH X79 Motherboard Qualified Vendors Lists (QVL) DDR3 1866 MHz capability\* (continued)

Vendors	Part No.	Size	SS/DS	Chip Brand	Chip NO.	Timing	Voltage	DIMM socket support (Optional)			
								2 DIMM	4 DIMM	6 DIMM	8 DIMM
AEXEA	AXA3ES2G2000LG28V(XMP)	2GB	DS	-	-	-	1.65	•	•	•	
AEXEA	AXA3ES4GK2000LG28V(XMP)	4GB(2x2GB)	DS	-	-	-	1.65	•	•	•	
Gingle	FA3URSS673A801A	2GB	DS	-	-	9-9-9-24	-	•	•		
Patriot	PX7312G2000ELK(XMP)	12GB(3x4GB)	DS	-	-	9-11-9-27	1.65	•	•	•	
Patriot	PV736G2000ELK(XMP)	6GB(3x2GB)	DS	-	-	7-7-7-20	1.65	•	•	•	
Silicon Power	SP002GBLYU200S02(XMP)	2GB	DS	-	-	-	-	•	•	•	
Team	TXD32048M2000C9(XMP)	2GB	DS	Team	T3D1288RT-20	9-9-9-24	1.5	•	•	•	
Team	TXD32048M2000C9-L(XMP)	2GB	DS	Team	T3D1288RT-20	9-9-9-24	1.6	•	•	•	

\* The above QVL is for the DDR3 2000 MHz memory module. Due to CPU behavior, DDR3 2000 MHz memory module will run at DDR3 1866 MHz frequency.

## SABERTOOTH X79 Motherboard Qualified Vendors Lists (QVL) DDR3 2133 MHz capability

Vendors	Part No.	Size	SS/DS	Chip Brand	Chip NO.	Timing	Voltage	DIMM socket support (Optional)			
								2 DIMM	4 DIMM	6 DIMM	8 DIMM
CORSAIR	CMT4GX3M2B2133C9(XMP)	4GB(2x2GB)	DS	-	-	9-10-9-27	1.5	•	•		
GEIL	GE34GB2133C9DC(XMP)	4GB(2x2GB)	DS	-	-	9-9-9-28	1.65	•	•		
KINGSTON	KHX2133C9AD3T1K2/4GX(XMP)	4GB(2x2GB)	DS	-	-	9	1.65	•	•		
KINGSTON	KHX2133C9AD3X2K2/4GX(XMP)	4GB(2x2GB)	DS	-	-	9	1.65	•	•		
Patriot	PVV34G2133C9K(XMP)	4GB(2x2GB)	DS	-	-	9-11-9-27	1.66	•	•		

## SABERTOOTH X79 Motherboard Qualified Vendors Lists (QVL) DDR3 2133 MHz capability\*

Vendors	Part No.	Size	SS/DS	Chip Brand	Chip NO.	Timing	Voltage	DIMM socket support (Optional)			
								2 DIMM	4 DIMM	6 DIMM	8 DIMM
G.SKILL	F3-17600CL7D-4GBFLS(XMP)	4G(2x2G)	DS	-	-	7-10-10-28	1.65	•	•		
G.SKILL	F3-17600CL8D-4GBPS(XMP)	4GB(2x2GB)	DS	-	-	8-8-8-24	1.65	•	•		
G.SKILL	F3-17600CL9D-4GBTDS(XMP)	4GB(2x2GB)	DS	-	-	9-9-9-24	1.65	•	•		
GEIL	GET34GB2200C9DC(XMP)	4GB(2x2GB)	DS	-	-	9-10-9-28	1.65	•	•		
GEIL	GET38GB2200C9ADC(XMP)	8GB(2x4GB)	DS	-	-	9-11-9-28	1.65	•	•		
KINGMAX	FLKE85F-B8KHA(XMP)	4G(2x2G)	DS	-	-	-	1.5~1.7	•	•		
KINGMAX	FLKE85F-B8KJAA-FEIS(XMP)	4GB(2x2GB)	DS	Kingmax	N/A	-	-	•	•		

\* The above QVL is for the DDR3 2200 MHz memory module. Due to CPU behavior, DDR3 2200 MHz memory module will run at DDR3 2133 MHz frequency.

## SABERTOOTH X79 Motherboard Qualified Vendors Lists (QVL) DDR3 2400 MHz capability

Vendors	Part No.	Size	SS/DS	Chip Brand	Chip NO.	Timing	Voltage	DIMM socket support (Optional)			
								2 DIMM	4 DIMM	6 DIMM	8 DIMM
CORSAIR	CMGTX3(XMP)	2GB	DS	-	-	9-11-9-27	1.65	•	•		
CORSAIR	CMGTX7(Ver5.11)	8GB(2x4GB)	-	-	-	9-9-9-24	1.65	•	•		
G.SKILL	F3-19200CL9D-4GBPIS(XMP)	4G(2x2G)	DS	-	-	9-11-9-28	1.65	•	•		
GEIL	GET34GB2400C9DC(XMP)	4GB(2x2GB)	DS	-	-	9-11-9-27	1.65	•	•		
Transcend	TX2400KLU-4GK(381850)(XMP)	2GB	DS	-	-	-	1.65	•	•		
Transcend	TX2400KLU-4GK(374243)(XMP)	2GB	DS	-	-	-	1.65	•	•		
Patriot	PVV34G2400C9K(XMP)	4GB(2x2GB)	DS	-	-	9-11-9-27	1.66	•	•		

## 2.2.4 Expansion slots



Ensure to unplug the power cord before adding or removing expansion cards. Failure to do so may cause you physical injury and damage motherboard components.

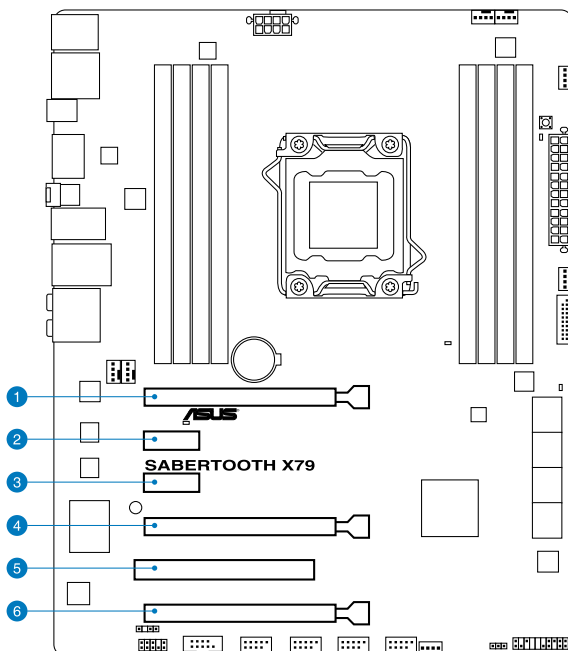

Slot No.	Slot Description
1	PCIe 3.0 x16_1 slot (single at x16 or dual at x16/x16 mode)
2	PCIe 2.0 x1_1 slot
3	PCIe 2.0 x1_2 slot
4	PCIe 3.0 x16_2 slot
5	PCI slot 1
6	PCIe 3.0 x16_3 slot (at x8 mode)

VGA configuration	PCI Express operating mode		
	PCIe x16_1	PCIe x16_2	PCIe x16_3
Single VGA/PCIe card	x16 (Recommend for single VGA)	N/A	N/A
Dual VGA/PCIe card	x16	x16	N/A



- In single VGA card mode, use the PCIe 3.0 x16\_1 slot (beige) for a PCI Express x16 graphics card to get better performance.
- In CrossFireX™ or SLI™ mode, use the PCIe 3.0 x16\_1 and PCIe 3.0 x16\_2 slots for PCI Express x16 graphics cards to get better performance.
- We recommend that you provide sufficient power when running CrossFireX™ or SLI™ mode. Refer to page 2-24 for details.
- Connect a chassis fan to the motherboard connector labeled CHA\_FAN1/2 when using multiple graphics cards for better thermal environment. See page 2-22 for details.

## IRQ assignments for this motherboard

	A	B	C	D	E	F	G	H
PCIEX16_1	shared	-	-	-	-	-	-	-
PCIEX16_2	shared	-	-	-	-	-	-	-
PCIEX16_3	shared	-	-	-	-	-	-	-
PCIEX1_1	-	-	-	shared	-	-	-	-
PCIEX1_2	shared	-	-	-	-	-	-	-
USB3.0 1	-	shared	-	-	-	-	-	-
USB3.0 2	-	-	shared	-	-	-	-	-
USB3.0 3	-	-	-	shared	-	-	-	-
eSATA	shared	-	-	-	-	-	-	-
Intel LAN	-	-	shared	-	-	-	-	-
Marvell 9128	-	-	-	shared	-	-	-	-
On Chip USB1	-	-	-	-	-	-	-	shared
On Chip USB2	-	-	-	-	-	-	-	shared
HD Audio	-	-	-	-	-	-	shared	-
On Chip SATA	-	-	-	-	shared	-	-	-
IEEE 1394	-	shared	-	-	-	-	-	-
PCI slot	shared	-	-	-	-	-	-	-

## 2.2.5 Jumper

### Clear RTC RAM (3-pin CLRRTC)

This jumper allows you to clear the Real Time Clock (RTC) RAM in CMOS. You can clear the CMOS memory of date, time, and system setup parameters by erasing the CMOS RTC RAM data. The onboard button cell battery powers the RAM data in CMOS, which include system setup information such as system passwords.

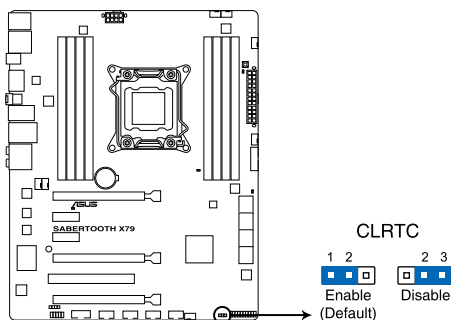

### SABERTOOTH X79 Clear RTC RAM

To erase the RTC RAM

1. Turn OFF the computer and unplug the power cord.
2. Move the jumper cap from pins 1-2 (default) to pins 2-3. Keep the cap on pins 2-3 for about 5–10 seconds, then move the cap back to pins 1-2.
3. Plug the power cord and turn ON the computer.
4. Hold down the <Del> key during the boot process and enter BIOS setup to re-enter data.



Except when clearing the RTC RAM, never remove the cap on CLRRTC jumper default position. Removing the cap will cause system boot failure!



- If the steps above do not help, remove the onboard battery and move the jumper again to clear the CMOS RTC RAM data. After the CMOS clearance, reinstall the battery.
- You do not need to clear the RTC when the system hangs due to overclocking. For system failure due to overclocking, use the C.P.R. (CPU Parameter Recall) feature. Shut down and reboot the system so the BIOS can automatically reset parameter settings to default values.
- Due to the chipset behavior, AC power off is required to enable C.P.R. function. You must turn off and on the power supply or unplug and plug the power cord before rebooting the system.



## 2.2.6 Onboard switch

The onboard switch allows you to fine-tune performance when working on a bare or open-case system. This is ideal for overclockers and gamers who continually change settings to enhance system performance.

### MemOK! switch

Installing DIMMs that are incompatible with the motherboard may cause system boot failure, and the DRAM\_LED near the MemOK! switch lights continuously. Press and hold the MemOK! switch until the DRAM\_LED starts blinking to begin automatic memory compatibility tuning for successful boot.

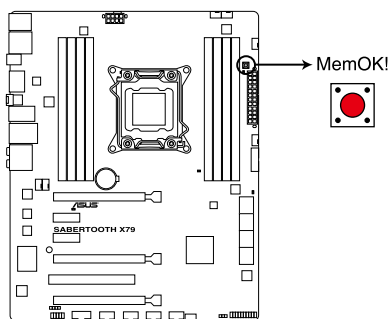

**SABERTOOTH X79 MemOK! switch**



- Refer to section **2.2.7 Onboard LEDs** for the exact location of the DRAM\_LED.
- The DRAM\_LED also lights when the DIMM is not properly installed. Turn off the system and reinstall the DIMM before using the MemOK! function.
- The MemOK! switch does not function under Windows™ OS environment.
- During the tuning process, the system loads and tests failsafe memory settings. It takes about 30 seconds for the system to test one set of failsafe settings. If the test fails, the system reboots and test the next set of failsafe settings. The blinking speed of the DRAM\_LED increases, indicating different test processes.
- Due to memory tuning requirement, the system automatically reboots when each timing set is tested. If the installed DIMMs still fail to boot after the whole tuning process, the DRAM\_LED lights continuously. Replace the DIMMs with ones recommended in the Memory QVL (Qualified Vendors Lists) in this user manual or on the ASUS website at [www.asus.com](http://www.asus.com).
- If you turn off the computer and replace DIMMs during the tuning process, the system continues memory tuning after turning on the computer. To stop memory tuning, turn off the computer and unplug the power cord for about 5–10 seconds.
- If your system fail to boot due to BIOS overclocking, press the MemOK! switch to boot and load BIOS default settings. A message will appear during POST reminding you that the BIOS has been restored to its default settings.
- We recommend that you download and update to the latest BIOS version from the ASUS website at [www.asus.com](http://www.asus.com) after using the MemOK! function.

## 2.2.7 Onboard LEDs

### 1. Standby Power LED

The motherboard comes with a standby power LED. The green LED lights up to indicate that the system is ON, in sleep mode, or in soft-off mode. This is a reminder that you should shut down the system and unplug the power cable before removing or plugging in any motherboard component. The illustration below shows the location of the onboard LED.

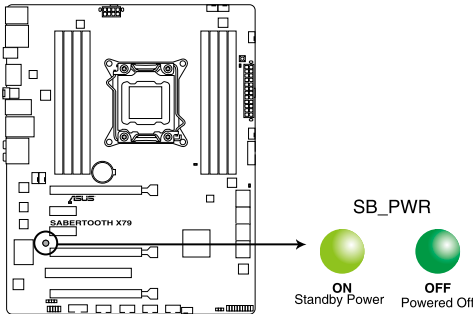

**SABERTOOTH X79 Onboard LED**

### 2. POST State LEDs

The POST State LEDs of CPU, DRAM, VGA card, and HDD indicate key components status during POST (Power-on Self Test). If an error is found, the LED next to the error device will continue lighting until the problem is solved. This user-friendly design provides an intuitional way to locate the root problem within a second.

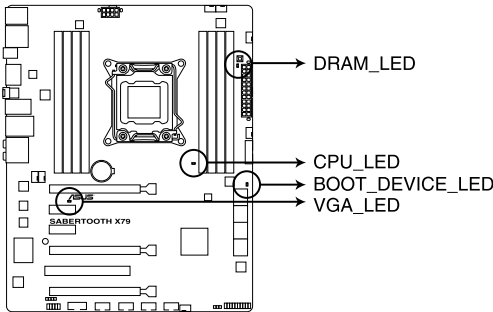

**SABERTOOTH X79 CPU/ DRAM/  
BOOT\_DEVICE/ VGA LED**

## 2.2.8 Internal connectors

### 1. Intel® X79 Serial ATA 6Gb/s connectors (7-pin SATA6G\_1/2 [brown])

These connectors connect to Serial ATA 6Gb/s hard disk drives via Serial ATA 6Gb/s signal cables.

If you installed Serial ATA hard disk drives, you can create a RAID 0, 1, 5, and 10 configuration with the Intel® Rapid Storage Technology through the onboard Intel® X79 chipset.

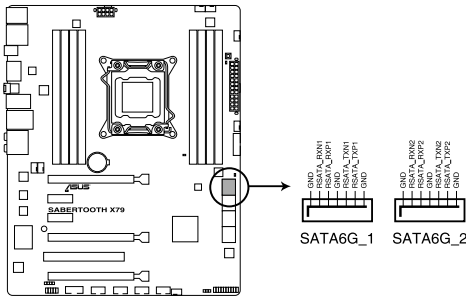

SABERTOOTH X79 Intel® SATA 6.0 Gb/s connectors

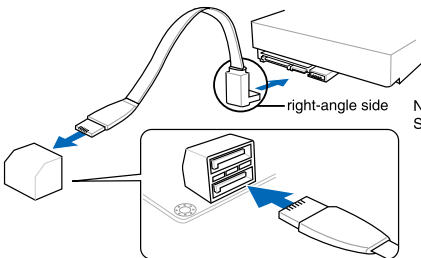

NOTE: Connect the right-angle side of SATA signal cable to SATA device.



- These connectors are set to [AHCI Mode] by default. If you intend to create a Serial ATA RAID set using these connectors, set the **SATA Mode** item in the BIOS to [RAID Mode]. Refer to section 3.5.3 **SATA Configuration** for details.
- Before creating a RAID set, refer to section 4.4 **RAID configurations** or the manual bundled in the motherboard support DVD.
- When using hot-plug and NCQ, set the **SATA Mode** in the BIOS to [AHCI Mode]. Refer to section 3.5.3 **SATA Configuration** for details.
- You must install Windows® XP Service Pack 3 or later versions before using Serial ATA hard disk drives. The Serial ATA RAID feature is available only if you are using Windows® XP Service Pack 3 or later versions.

## 2. Intel® X79 Serial ATA 3Gb/s connectors (7-pin SATA3G\_3–6 [black])

These connectors connect to Serial ATA 3Gb/s hard disk drives and optical disc drives via Serial ATA 3Gb/s signal cables.

If you installed Serial ATA hard disk drives, you can create a RAID 0, 1, 5, and 10 configuration with the Intel® Rapid Storage Technology through the onboard Intel® X79 chipset.

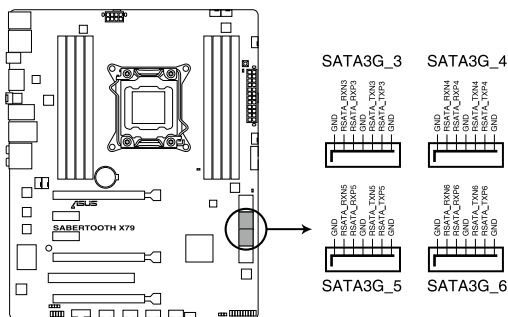

**SABERTOOTH X79 Intel® SATA 3.0 Gb/s connectors**



- These connectors are set to [AHCI Mode] by default. If you intend to create a Serial ATA RAID set using these connectors, set the **SATA Mode** item in the BIOS to [RAID Mode]. Refer to section **3.5.3 SATA Configuration** for details.
- Before creating a RAID set, refer to section **4.4 RAID configurations** or the manual bundled in the motherboard support DVD.
- When using hot-plug and NCQ, set the **SATA Mode** in the BIOS to [AHCI Mode]. Refer to section **3.5.3 SATA Configuration** for details.
- You must install Windows® XP Service Pack 3 or later versions before using Serial ATA hard disk drives. The Serial ATA RAID feature is available only if you are using Windows® XP Service Pack 3 or later versions.

### 3. Marvell® Serial ATA 6Gb/s connectors (7-pin SATA6G\_E1/E2 [gray])

These connectors connect to Serial ATA 6Gb/s hard disk drives via Serial ATA 6Gb/s signal cables.

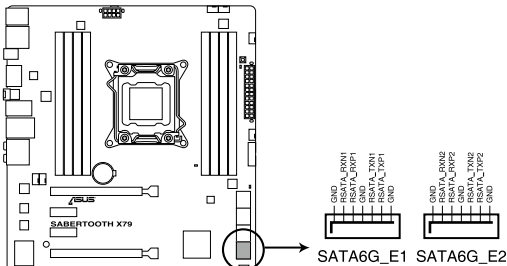

**SABERTOOTH X79 Marvell® SATA 6.0 Gb/s connectors**



- The SATA6G\_E1/E2 (gray) connectors do not support ATAPI devices.
- You must install Windows® XP Service Pack 3 or later versions before using Serial ATA hard disk drives.
- For high performance of ASUS SSD Caching, please connect one HDD and one SSD to Marvell® SATA6G\_E1/E2 connectors.
- For regular usage, the SATA6G\_E1/E2 connectors are recommended for data drives.
- When using hot-plug and NCQ, set the **Marvell Storage Controller** item in the BIOS to [Enabled]. Refer to section **3.5.5 Onboard Devices Configuration** for details.
- Press <Ctrl> + <M> during POST to enter the Marvell RAID utility to create or delete a RAID configuration.
- If you want to install a Windows® operating system to a RAID configuration created using the Marvell® SATA controller, you have to create a RAID driver disk using the motherboard support DVD and load the driver during OS installation. For 32/64-bit Windows XP OS, load first the **Marvell shared library driver**, and then load **Marvell 91xx SATA Controller Driver**. For Windows Vista / Windows7 OS, load only the **Marvell 91xx SATA Controller Driver**.

#### 4. Serial port connector (10-1 pin COM1)

This connector is for a serial (COM) port. Connect the serial port module cable to this connector, then install the module to a slot opening at the back of the system chassis.

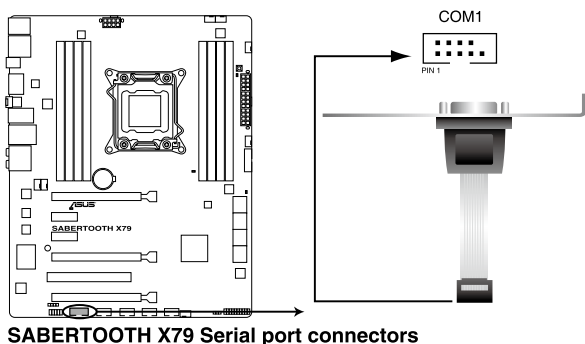

**SABERTOOTH X79 Serial port connectors**



The COM module is purchased separately.

#### 5. USB 3.0 connector (20-pin USB3\_56)

This connector is for the additional USB 3.0 ports, and complies with the USB 3.0 specification that supports up to 4.8 Gbps connection speed. If the USB 3.0 front panel cable is available from your system chassis, with this USB 3.0 connector, you can have a front panel USB 3.0 solution.

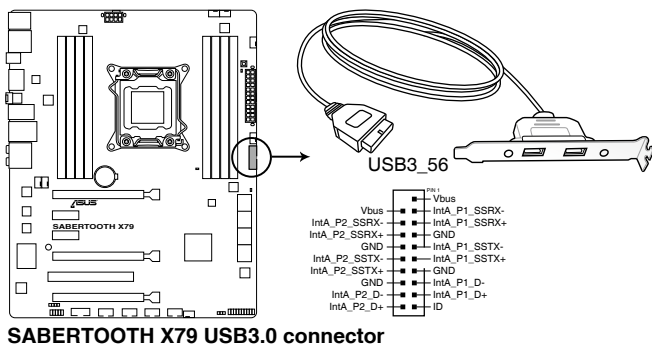

**SABERTOOTH X79 USB3.0 connector**



The USB 3.0 module is purchased separately.

## 6. USB 2.0 connectors (10-1 pin USB78, USB910, USB1112, USB1314)

These connectors are for USB 2.0 ports. Connect the USB module cable to any of these connectors, then install the module to a slot opening at the back of the system chassis.

These USB connectors comply with USB 2.0 specification that supports up to 480 Mbps connection speed.

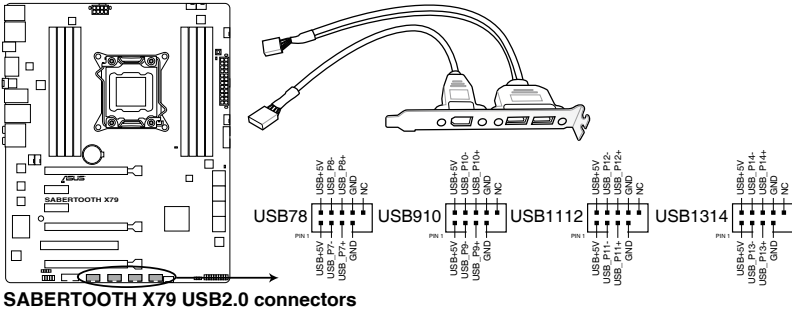

**SABERTOOTH X79 USB2.0 connectors**



Never connect a 1394 cable to the USB connectors. Doing so will damage the motherboard!



You can connect the front panel USB cable to the ASUS Q-Connector (USB, blue) first, and then install the Q-Connector (USB) to the USB connector onboard if your chassis supports front panel USB ports.

## 7. Digital audio connector (4-1 pin SPDIF\_OUT)

This connector is for an additional Sony/Philips Digital Interface (S/PDIF) port(s). Connect the S/PDIF Out module cable to this connector, then install the module to a slot opening at the back of the system chassis.

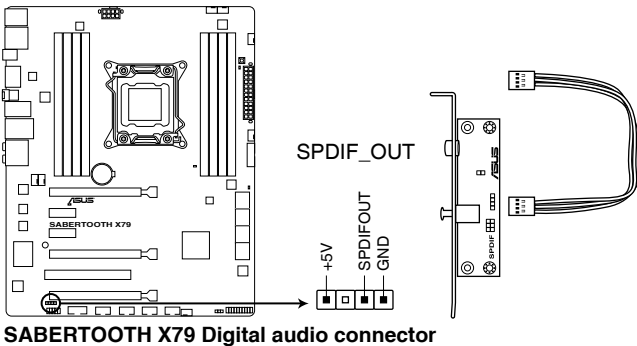

**SABERTOOTH X79 Digital audio connector**



The S/PDIF module is purchased separately.

## 8. CPU, chassis, and assistant fan connectors (4-pin CPU\_FAN; 4-pin CPU\_OPT FAN; 4-pin CHA\_FAN1-4; 4-pin ASST\_FAN)

Connect the fan cables to the fan connectors on the motherboard, ensuring that the black wire of each cable matches the ground pin of the connector.

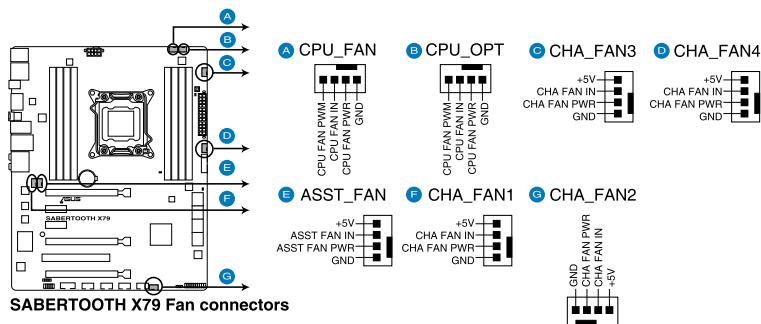

Do not forget to connect the fan cables to the fan connectors. Insufficient air flow inside the system may damage the motherboard components. These are not jumpers! Do not place jumper caps on the fan connectors!



- The CPU\_FAN connector supports the CPU fan of maximum 1A (12 W) fan power.
- If you install two VGA cards, we recommend that you plug the rear chassis fan cable to the motherboard connector labeled CHA\_FAN1 or CHA\_FAN2 for better thermal environment.



## 9. Front panel audio connector (10-1 pin AAFP)

This connector is for a chassis-mounted front panel audio I/O module that supports either HD Audio or legacy AC'97 audio standard. Connect one end of the front panel audio I/O module cable to this connector.

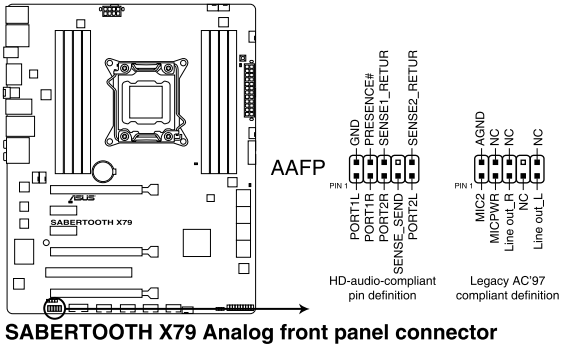

- We recommend that you connect a high-definition front panel audio module to this connector to avail of the motherboard's high-definition audio capability.
- If you want to connect a high-definition front panel audio module to this connector, set the **Front Panel Type** item in the BIOS setup to **[HD]**; if you want to connect an AC'97 front panel audio module to this connector, set the item to **[AC97]**. By default, this connector is set to **[HD]**.

## 10. ATX power connectors (24-pin EATXPWR; 8-pin EATX12V)

These connectors are for ATX power supply plugs. The power supply plugs are designed to fit these connectors in only one orientation. Find the proper orientation and push down firmly until the connectors completely fit.

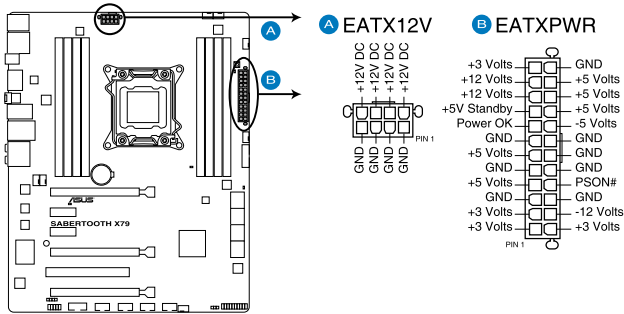

**SABERTOOTH X79 ATX power connectors**



- For a fully configured system, we recommend that you use a power supply unit (PSU) that complies with ATX 12 V Specification 2.0 (or later version) and provides a minimum power of 450 W.
- Do not forget to connect the 4-pin/8-pin EATX12 V power plug; otherwise, the system will not boot.
- Use of a PSU with a higher power output is recommended when configuring a system with more power-consuming devices. The system may become unstable or may not boot up if the power is inadequate.
- If you want to use two or more high-end PCI Express x16 cards, use a PSU with 1000W power or above to ensure the system stability.
- If you are uncertain about the minimum power supply requirement for your system, refer to the Recommended Power Supply Wattage Calculator at <http://support.asus.com/PowerSupplyCalculator/PSCalculator.aspx?SLanguage=en-us> for details.

## 11. System panel connector (20-8 pin PANEL)

This connector supports several chassis-mounted functions.

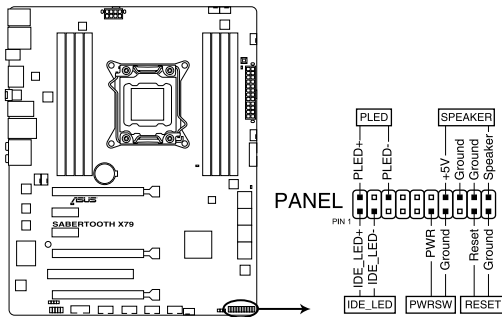

**SABERTOOTH X79 System panel connector**

- **System power LED (2-pin PLED)**

This 2-pin connector is for the system power LED. Connect the chassis power LED cable to this connector. The system power LED lights up when you turn on the system power, and blinks when the system is in sleep mode.

- **Hard disk drive activity LED (2-pin IDE\_LED)**

This 2-pin connector is for the HDD Activity LED. Connect the HDD Activity LED cable to this connector. The IDE LED lights up or flashes when data is read from or written to the HDD.

- **System warning speaker (4-pin SPEAKER)**

This 4-pin connector is for the chassis-mounted system warning speaker. The speaker allows you to hear system beeps and warnings.

- **ATX power button/soft-off button (2-pin PWRSW)**





This connector is for the system power button. Pressing the power button turns the system on or puts the system in sleep or soft-off mode depending on the BIOS settings. Pressing the power switch for more than four seconds while the system is ON turns the system OFF.

- **Reset button (2-pin RESET)**

This 2-pin connector is for the chassis-mounted reset button for system reboot without turning off the system power.

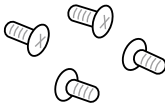
## 2.3 Building your computer system

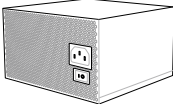
### 2.3.1 Additional tools and components to build a PC system

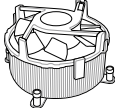
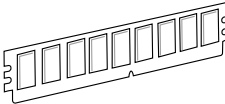
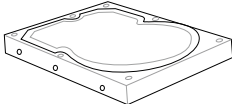
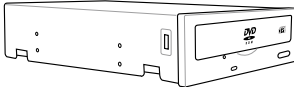
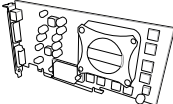
	
<b>1 bag of screws</b>	<b>Philips (cross) screwdriver</b>
	
<b>PC chassis</b>	<b>Power supply unit</b>
	
<b>Intel LGA 2011 CPU</b>	<b>Intel LGA 2011 compatible CPU Fan</b>
	
<b>DIMM</b>	<b>SATA hard disk drive</b>
	
<b>SATA optical disc drive (optional)</b>	<b>Graphics card (optional)</b>



The tools and components in the table above are not included in the motherboard package.

## 2.3.2 CPU installation



Please note the order in opening/ closing the double latch. Follow the instructions printed on the metal sealing hatch or the illustrations shown below in this manual. The plastic cap will pop up automatically once the CPU is in place and the hatch properly sealed down.

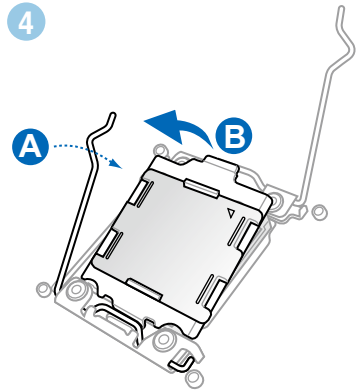
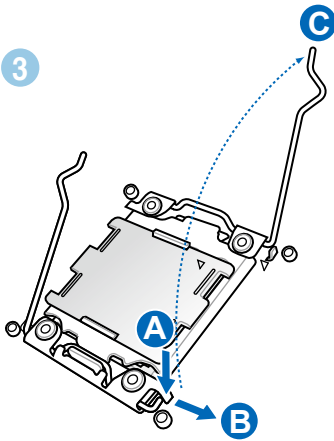
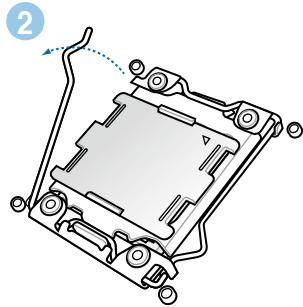
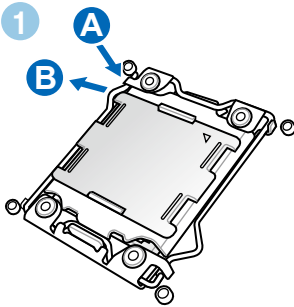

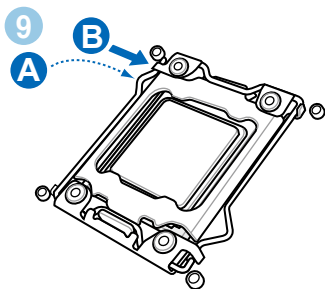
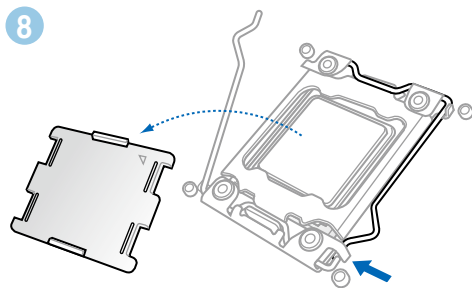
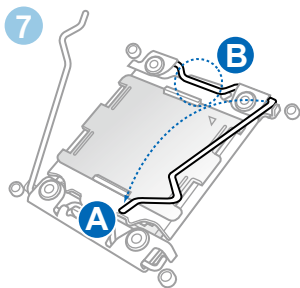
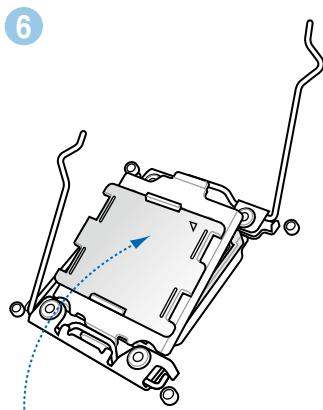
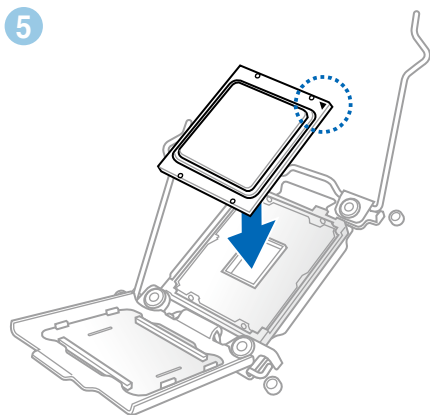

### 2.3.3 CPU heatsink and fan assembly installation

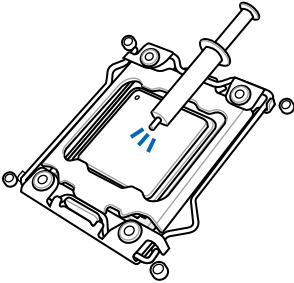

Apply the Thermal Interface Material to the CPU heatsink and CPU before you install the heatsink and fan if necessary.

To install the CPU heatsink and fan assembly

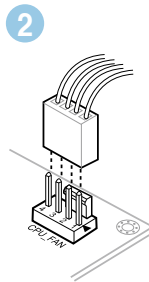
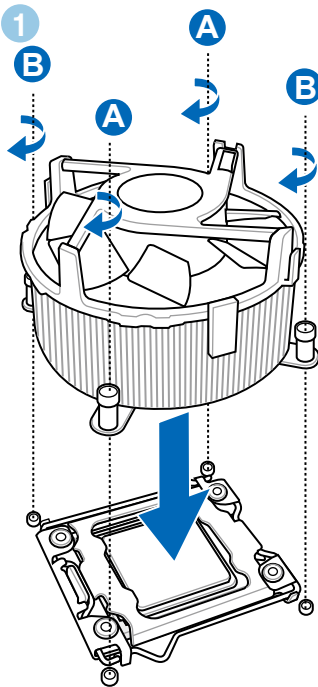

### 2.3.4 DIMM installation

1

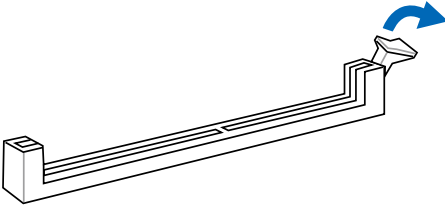

2

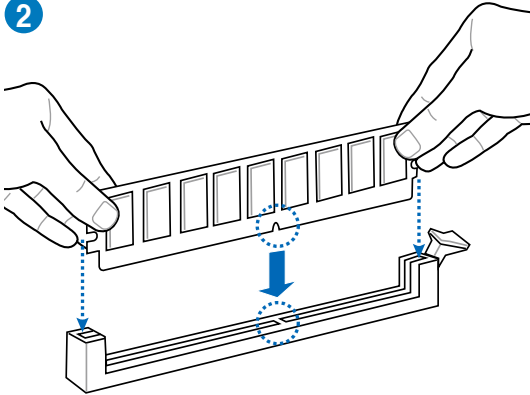

3

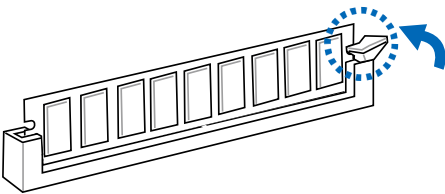

#### To remove a DIMM

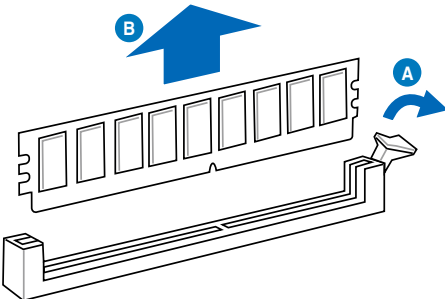



## 2.3.5 Motherboard installation



The diagrams in this section are for reference only. The motherboard layout may vary with models, but the installation steps remain the same.

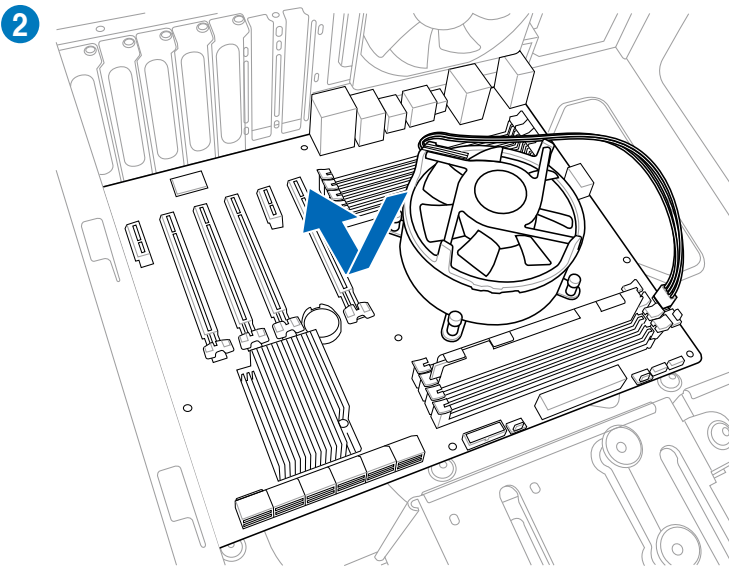
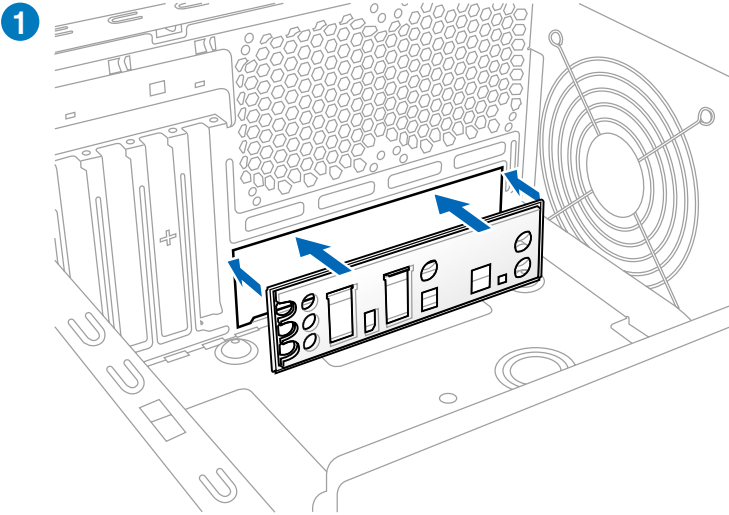

3

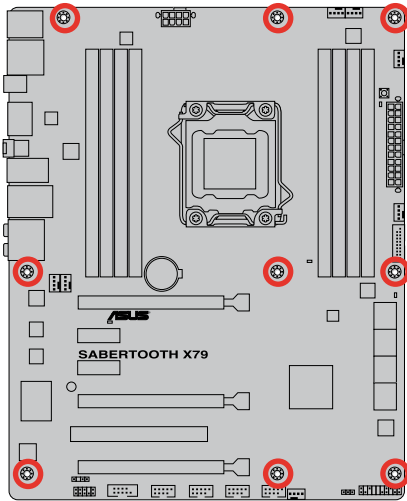
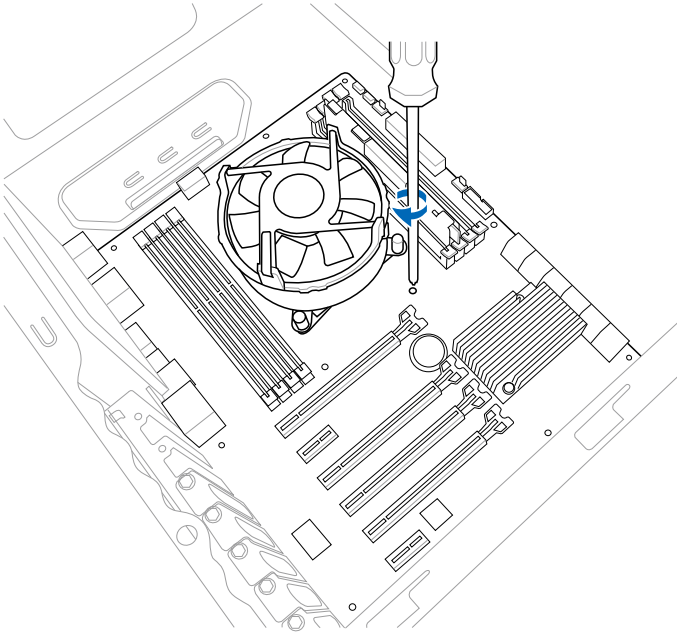

DO NOT overtighten the screws! Doing so can damage the motherboard.

### 2.3.6 Thermal Armor for ASUS SABERTOOTH X79

The Thermal Armor for ASUS SABERTOOTH X79 consists of a rear I/O cover and a PCH cover and fan assembly, providing effective dissipation of the heat generated from the motherboard components. To ensure the most optimum heat dissipation, follow the instruction below to install the I/O cover fan to the rear I/O cover.

1. Remove the two screws on the rear I/O cover, and then remove the lid to show the fan socket.
2. Place the rear I/O cover fan into the fan socket, ensuring that the TUF logo on the fan is facing up.
3. Secure the fan to the socket using the screws removed in step 1 and the long fan screws in accessory pack.

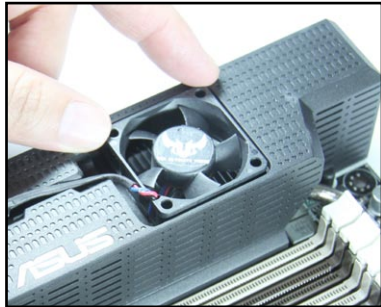
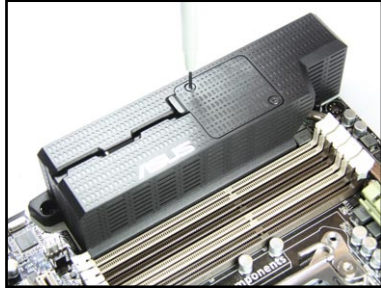

4. Place the fan cable into the cable slot on the rear I/O cover.



5. Connect the fan cable to the **ASST\_FAN** connector on the motherboard.

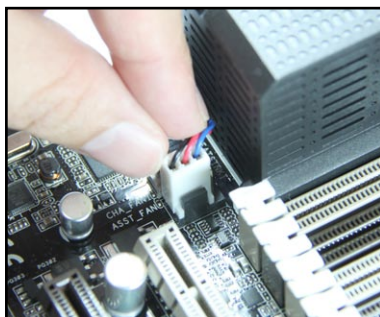

6. The PCH cover is pre-assembled with a slim-type fan, providing effective heat dissipation to the PCH. Remove the protection film on the PCH cover before use.



---

If the PCH fan is not working or the fan speed is too slow, check if the fan cable is well-connected. If the problem persists, refer to local ASUS service centers for help.

---

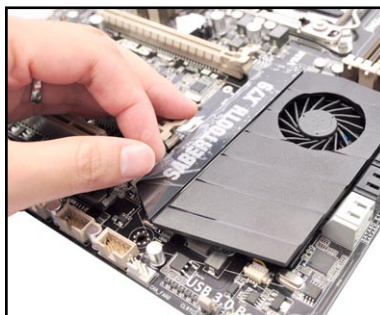

### 2.3.7 ATX Power connection

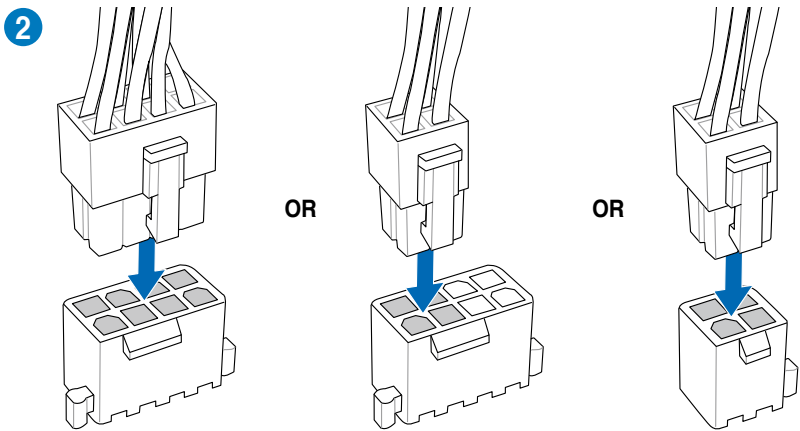
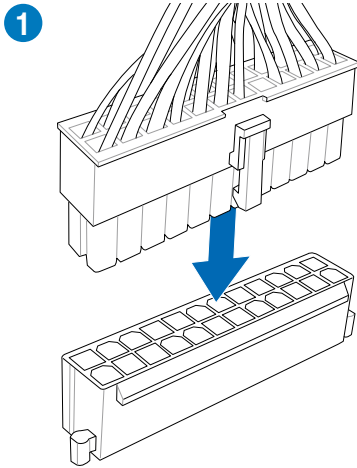

### 2.3.8 SATA device connection

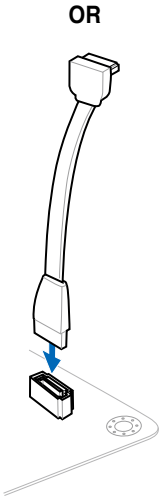
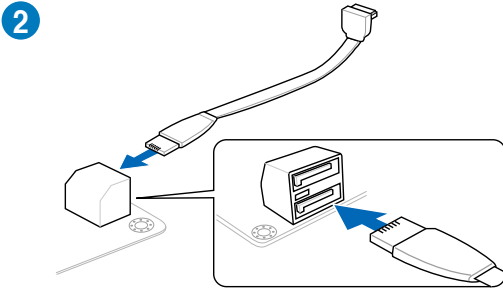
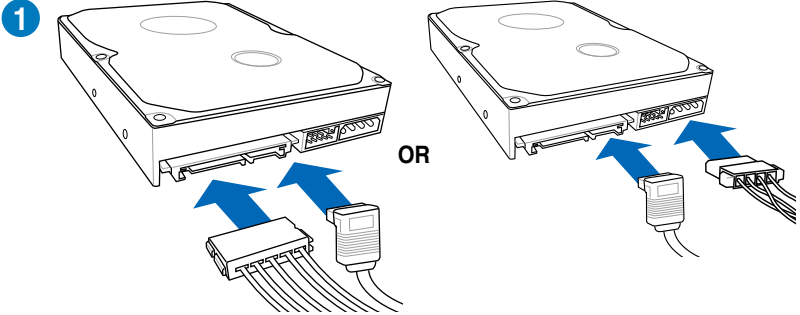

## 2.3.9 Front I/O Connector

### To install ASUS Q-Connector

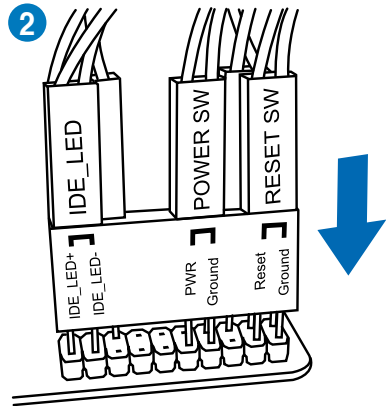
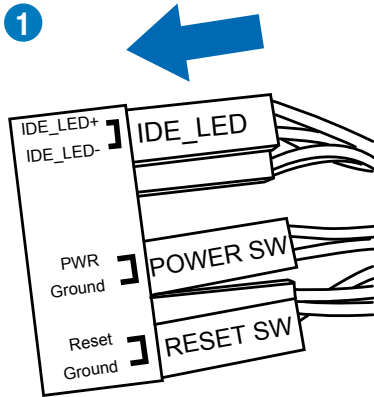

### To install USB 2.0 Connector

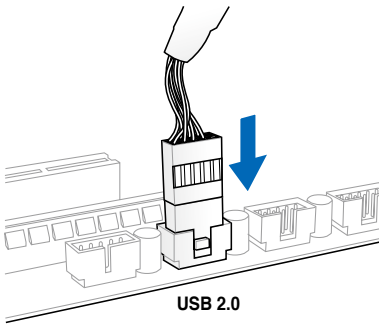

### To install front panel audio connector

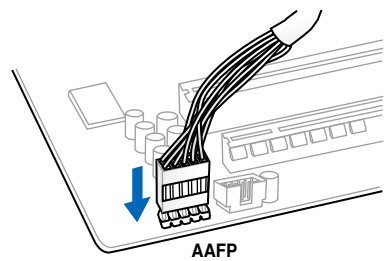

### To install USB 3.0 Connector

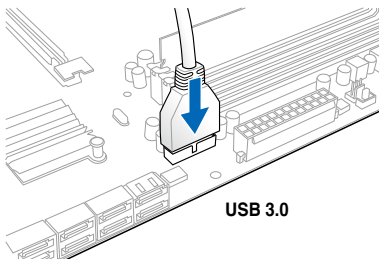

## 2.3.10 Expansion Card installation

To install PCIe x16 cards

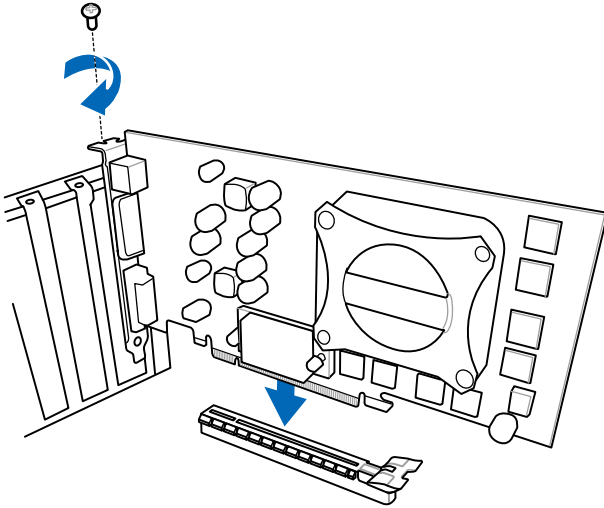

To install PCIe x1 cards

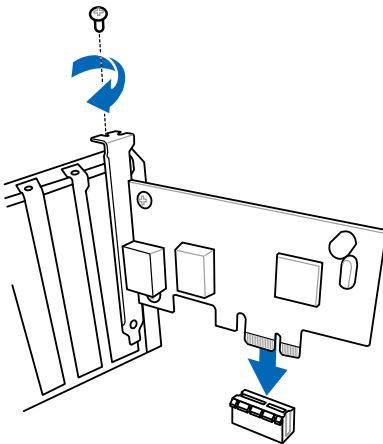

To install PCI cards

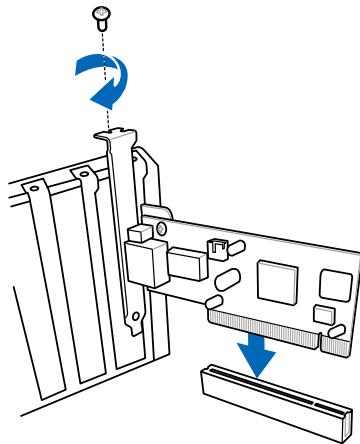



### 2.3.11 Rear panel connection

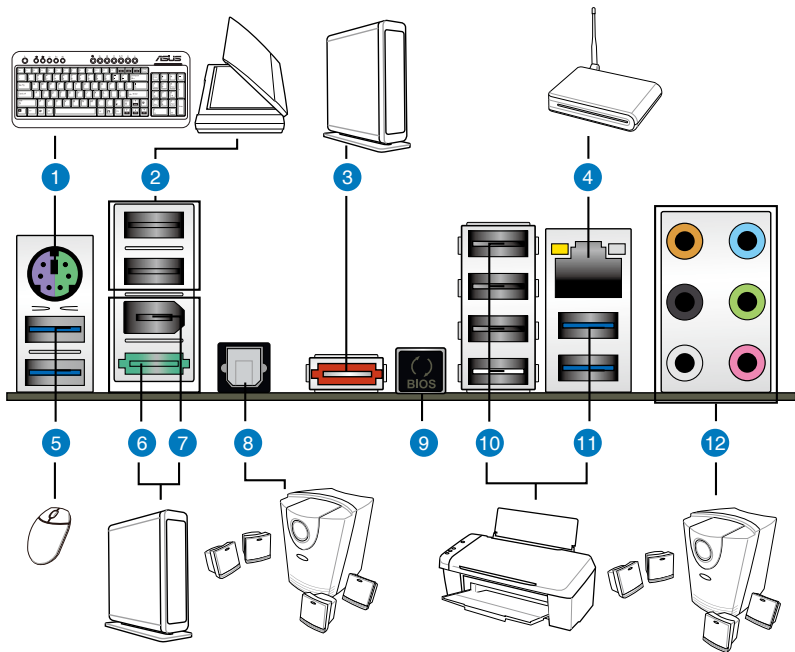

#### Rear panel connectors

1. PS/2 keyboard/mouse combo port	7. IEEE 1394a port
2. USB 2.0 ports 5 and 6	8. Optical S/PDIF Out port
3. External SATA port	9. USB BIOS Flashback button
4. LAN (RJ-45) port*	10. USB 2.0 ports 1,2,3 and 4
5. USB 3.0 ports 3 and 4	11. USB 3.0 ports 1 and 2
6. Power eSATA 6G port	12. Audio I/O ports**

\* and \*\*: Refer to the tables on the next page for LAN port LED and audio port definitions.



- DO NOT insert a different connector to the external SATA port.
- DO NOT connect a keyboard/mouse to any USB 3.0 port when installing Windows® operating system.
- Due to USB 3.0 controller limitation, USB 3.0 devices can only be used under Windows® OS environment and after the USB 3.0 driver installation.
- USB 3.0 devices can only be used as data storage only.
- We strongly recommend that you connect USB 3.0 devices to USB 3.0 ports for faster and better performance for your USB 3.0 devices.
- If you want to use the hot-plug function of the external SATA ports, you have to set the **ASM1061 Storage Controller** item in the BIOS setting to [AHCI Mode] and install the **Asmedia SATA Controller Driver** from the motherboard support DVD. Refer to section 3.5.5 **Onboard Devices Configuration** for details.

### \* LAN ports LED indications

Activity Link LED		Speed LED	
Status	Description	Status	Description
OFF	No link	OFF	10 Mbps connection
ORANGE	Linked	ORANGE	100 Mbps connection
BLINKING	Data activity	GREEN	1 Gbps connection

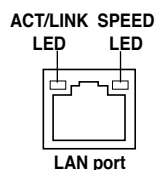

### \*\* Audio 2, 4, 6, or 8-channel configuration

Port	Headset 2-channel	4-channel	6-channel	8-channel
Light Blue	Line In	Line In	Line In	Line In
Lime	Line Out	Front Speaker Out	Front Speaker Out	Front Speaker Out
Pink	Mic In	Mic In	Mic In	Mic In
Orange	–	–	Center/Subwoofer	Center/Subwoofer
Black	–	Rear Speaker Out	Rear Speaker Out	Rear Speaker Out
Gray	–	–	–	Side Speaker Out

## 2.3.12 Audio I/O connections

### Audio I/O ports

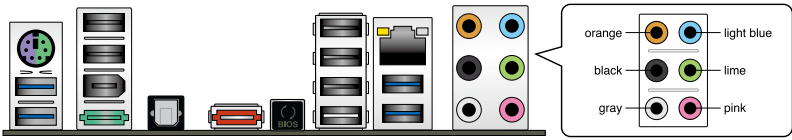

### Connect to Headphone and Mic



### Connect to Stereo Speakers

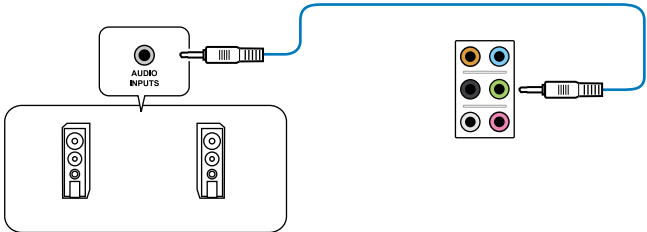

### Connect to 2.1 channel Speakers

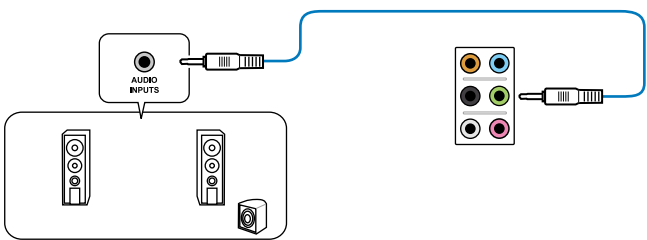

### Connect to 4.1 channel Speakers

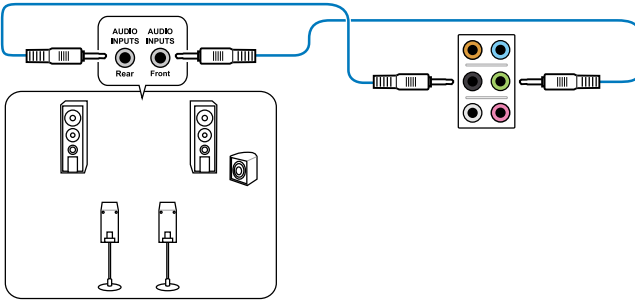

### Connect to 5.1 channel Speakers

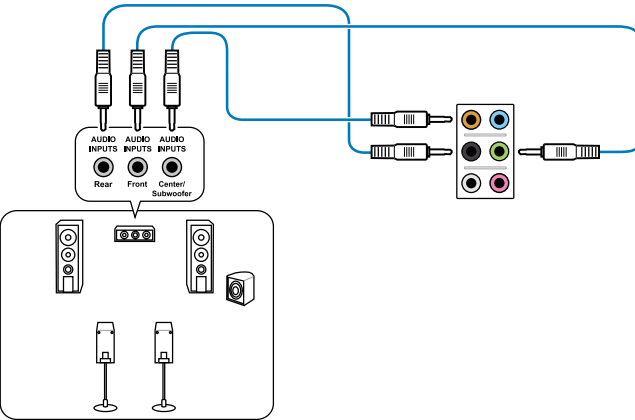

### Connect to 7.1 channel Speakers

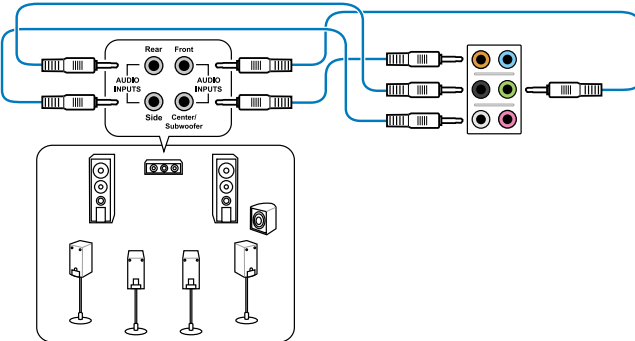

### 2.3.13 USB BIOS Flashback

1. Download the BIOS ROM file from the ASUS service website ([www.asus.com](http://www.asus.com)). Save the ROM file to a USB portable disk.
2. On the rear I/O port, plug the USB disk to the USB port with the WHITE interior. (See red box in the image below)
3. Press the BIOS Flashback button for 3 seconds, and the light will begin to flash (on the third second).
4. The Flashback function is enabled once the light starts to flash.
5. The flashing rate of the light signal accelerates along with the updating speed.

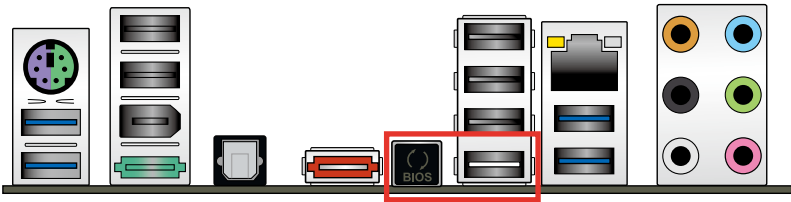

Updating BIOS may have risks. If the BIOS program is damaged during the process causing the system unable to reboot, please contact the local service station for help.

## 2.4 Starting up for the first time

1. After making all the connections, replace the system case cover.
2. Be sure that all switches are off.
3. Connect the power cord to the power connector at the back of the system chassis.
4. Connect the power cord to a power outlet that is equipped with a surge protector.
5. Turn on the devices in the following order:
  - a. Monitor
  - b. External SCSI devices (starting with the last device on the chain)
  - c. System power
6. After applying power, the system power LED on the system front panel case lights up. For systems with ATX power supplies, the system LED lights up when you press the ATX power button. If your monitor complies with the “green” standards or if it has a “power standby” feature, the monitor LED may light up or change from orange to green after the system LED turns on.

The system then runs the power-on self tests or POST. While the tests are running, the BIOS beeps (refer to the BIOS beep codes table below) or additional messages appear on the screen. If you do not see anything within 30 seconds from the time you turned on the power, the system may have failed a power-on test. Check the jumper settings and connections or call your retailer for assistance.

BIOS Beep	Description
One short beep	VGA detected Quick boot set to disabled No keyboard detected
One continuous beep followed by two short beeps then a pause (repeated)	No memory detected
One continuous beep followed by three short beeps	No VGA detected
One continuous beep followed by four short beeps	Hardware component failure

7. At power on, hold down the <Delete> key to enter the BIOS Setup. Follow the instructions in Chapter 3.

## 2.5 Turning off the computer

While the system is ON, pressing the power switch for less than four seconds puts the system on sleep mode or soft-off mode, depending on the BIOS setting. Pressing the power switch for more than four seconds lets the system enter the soft-off mode regardless of the BIOS setting.

# Chapter 3

## 3.1 Knowing BIOS



The new ASUS UEFI BIOS is an Unified Extensible Firmware Interface that complies with UEFI architecture, offering a user-friendly interface that goes beyond traditional keyboard-only BIOS controls to enable more flexible and convenient mouse input. Users can easily navigate the new UEFI BIOS with the same smoothness as their operating system. The term "BIOS" in this user manual refers to "UEFI BIOS" unless otherwise specified.

BIOS (Basic Input and Output System) stores system hardware settings such as storage device configuration, overclocking settings, advanced power management, and boot device configuration that are needed for system startup in the motherboard CMOS. In normal circumstances, the default BIOS settings apply to most conditions to ensure optimum performance. **We recommend that you not change the default BIOS settings** except in the following circumstances:

- An error message appears on the screen during the system bootup and requests you to run the BIOS Setup.
- You have installed a new system component that requires further BIOS settings or update.



Inappropriate settings of the BIOS may result in instability or failure to boot. **We strongly recommend that you change the BIOS settings only with the help of a trained service personnel.**

## 3.2 BIOS setup program

A BIOS setup program is provided for BIOS item modification. When you start up the computer, the system provides you with the opportunity to run this program. Press <Del> during the Power-On Self-Test (POST) to enter the Setup utility. Otherwise, POST continues with its test routines.

If you wish to enter Setup after POST, press <Ctrl> + <Alt> + <Delete>, or press the reset button on the system chassis to restart the system. You can also turn the system off and then turn it back on to restart the system. Do this last option only if the first two failed.



- The BIOS setup screens shown in this section are for reference purposes only, and may not exactly match what you see on your screen.
- Ensure that a USB mouse is connected to your motherboard if you want to use the mouse to control the BIOS setup program.
- If the system becomes unstable after changing any BIOS setting, load the default settings to ensure system compatibility and stability. Select the **Load Optimized Defaults** item under the **Exit** menu. See section 3.9 **Exit Menu** for details.
- If the system fails to boot after changing any BIOS setting, try to clear the CMOS and reset the motherboard to the default value. See section 2.2.5 **Jumper** for information on how to erase the RTC RAM.
- The BIOS setup program does not support the bluetooth devices.

The BIOS setup program is designed to make it as easy to use as possible. Being a menu-driven program, it lets you scroll through the various submenus and select from the available options using a keyboard or a USB mouse.

The BIOS setup program can be used under two modes: **EZ Mode** and **Advanced Mode**. You can change modes from the **Exit** menu or from the **Exit/Advanced Mode** button in the **EZ Mode/Advanced Mode** screen.

### 3.2.1 EZ Mode

By default, the EZ Mode screen appears when you enter the BIOS setup program. The EZ Mode provides you an overview of the basic system information, and allows you to select the display language, system performance mode and boot device priority. To access the Advanced Mode, click **Exit/Advanced Mode**, then select **Advanced Mode**.



The default screen for entering the BIOS setup program can be changed. Refer to the **Setup Mode** item in section 3.7 **Boot menu** for details.

**Displays the CPU/motherboard temperature, CPU/5V/3.3V/12V voltage output, CPU/CPU\_OPT/Chassis fan speed**

**Selects the display language of the BIOS setup program**

**Clicks to display all fan speeds if available**

**Exits the BIOS setup program without saving the changes, saves the changes and resets the system, or enters the Advanced Mode**

**Quick switch to frequently used menus.**

**Selects the boot device priority**

**Power Saving mode**

**Normal mode**

**ASUS Optimal mode**

**Loads optimized default**

**Displays the system properties of the selected mode on the right hand side**

**Selects the boot device priority**



- The boot device options vary depending on the devices you installed to the system.
- The **Boot Menu(F8)** button is available only when the boot device is installed to the system.



### 3.2.2 Advanced Mode

The Advanced Mode provides advanced options for experienced end-users to configure the BIOS settings. The figure below shows an example of the Advanced Mode. Refer to the following sections for the detailed configurations.



To access the EZ Mode, click **Exit**, then select **ASUS EZ Mode**.

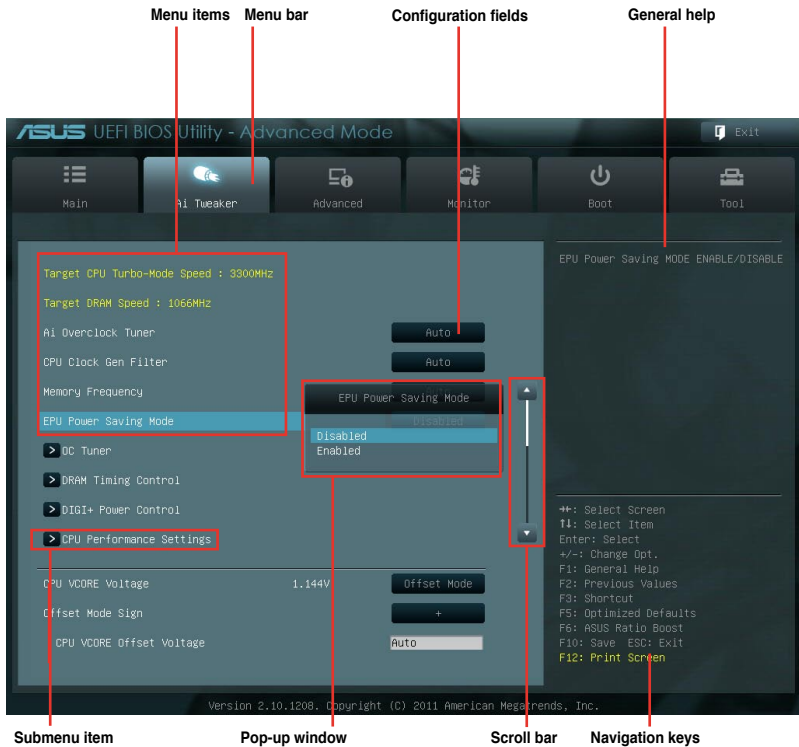

#### Menu bar

The menu bar on top of the screen has the following main items:

<b>Main</b>	For changing the basic system configuration
<b>Ai Tweaker</b>	For changing the overclocking settings
<b>Advanced</b>	For changing the advanced system settings
<b>Monitor</b>	For displaying the system temperature, power status, and changing the fan settings.
<b>Boot</b>	For changing the system boot configuration
<b>Tool</b>	For configuring options for special functions
<b>Exit</b>	For selecting the exit options and loading default settings

## Menu items

The highlighted item on the menu bar displays the specific items for that menu. For example, selecting **Main** shows the Main menu items.

The other items (Ai Tweaker, Advanced, Monitor, Boot, Tool, and Exit) on the menu bar have their respective menu items.

## Back button

This button appears when entering a submenu. Press <Esc> or use the USB mouse to click this button to return to the previous menu screen.

## Submenu items

A greater than sign (>) before each item on any menu screen means that the item has a submenu. To display the submenu, select the item and press <Enter>.

## Pop-up window

Select a menu item and press <Enter> to display a pop-up window with the configuration options for that item.

## Scroll bar

A scroll bar appears on the right side of a menu screen when there are items that do not fit on the screen. Press the Up/Down arrow keys or <Page Up> / <Page Down> keys to display the other items on the screen.

## Navigation keys

At the bottom right corner of the menu screen are the navigation keys for the BIOS setup program. Use the navigation keys to select items in the menu and change the settings. Use <F12> key to capture the BIOS screen and save it to the removable storage device.

## General help

At the top right corner of the menu screen is a brief description of the selected item.

## Configuration fields

These fields show the values for the menu items. If an item is user-configurable, you can change the value of the field opposite the item. You cannot select an item that is not user-configurable.

A configurable field is highlighted when selected. To change the value of a field, select it and press <Enter> to display a list of options.

## 3.3 Main menu

The Main menu screen appears when you enter the Advanced Mode of the BIOS Setup program. The Main menu provides you an overview of the basic system information, and allows you to set the system date, time, language, and security settings.

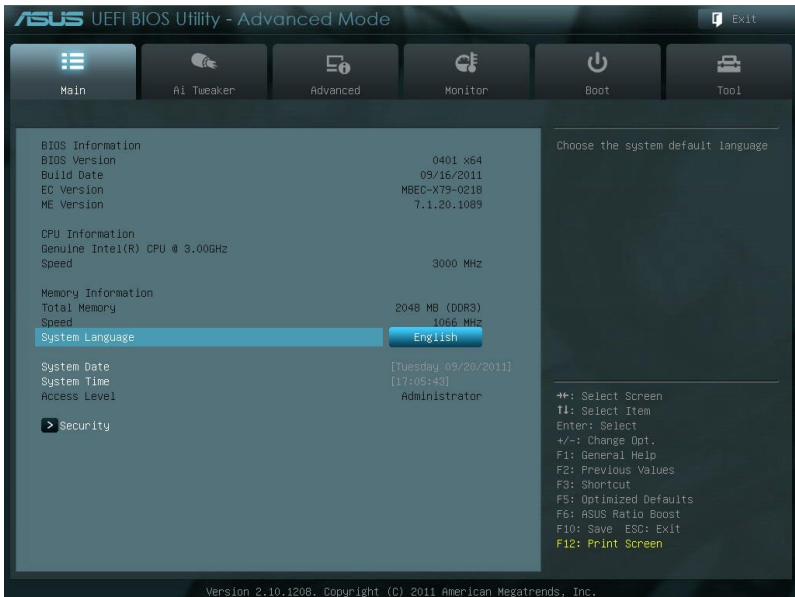

### Security

The Security menu items allow you to change the system security settings.

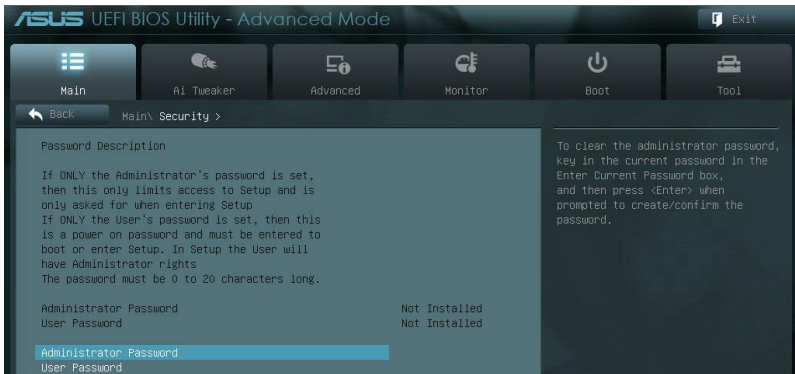

- If you have forgotten your BIOS password, erase the CMOS Real Time Clock (RTC) RAM to clear the BIOS password. See section 2.2.5 Jumper for information on how to erase the RTC RAM.
- The **Administrator** or **User Password** items on top of the screen show the default **Not Installed**. After you set a password, these items show **Installed**.

## Administrator Password

If you have set an administrator password, we recommend that you enter the administrator password for accessing the system. Otherwise, you might be able to see or change only selected fields in the BIOS setup program.

To set an administrator password:

1. Select the **Administrator Password** item and press <Enter>.
2. From the **Create New Password** box, key in a password, then press <Enter>.
3. Confirm the password when prompted.

To change an administrator password:

1. Select the **Administrator Password** item and press <Enter>.
2. From the **Enter Current Password** box, key in the current password, then press <Enter>.
3. From the **Create New Password** box, key in a new password, then press <Enter>.
4. Confirm the password when prompted.

To clear the administrator password, follow the same steps as in changing an administrator password, but press <Enter> when prompted to create/confirm the password. After you clear the password, the **Administrator Password** item on top of the screen shows **Not Installed**.

## User Password

If you have set a user password, you must enter the user password for accessing the system. The **User Password** item on top of the screen shows the default **Not Installed**. After you set a password, this item shows **Installed**.

To set a user password:

1. Select the **User Password** item and press <Enter>.
2. From the **Create New Password** box, key in a password, then press <Enter>.
3. Confirm the password when prompted.

To change a user password:

1. Select the **User Password** item and press <Enter>.
2. From the **Enter Current Password** box, key in the current password, then press <Enter>.
3. From the **Create New Password** box, key in a new password, then press <Enter>.
4. Confirm the password when prompted.

To clear the user password, follow the same steps as in changing a user password, but press <Enter> when prompted to create/confirm the password. After you clear the password, the **User Password** item on top of the screen shows **Not Installed**.

## 3.4 Ai Tweaker menu

The Ai Tweaker menu items allow you to configure overclocking-related items.



Be cautious when changing the settings of the Ai Tweaker menu items. Incorrect field values can cause the system to malfunction.



The configuration options for this section vary depending on the CPU and DIMM model you installed on the motherboard.

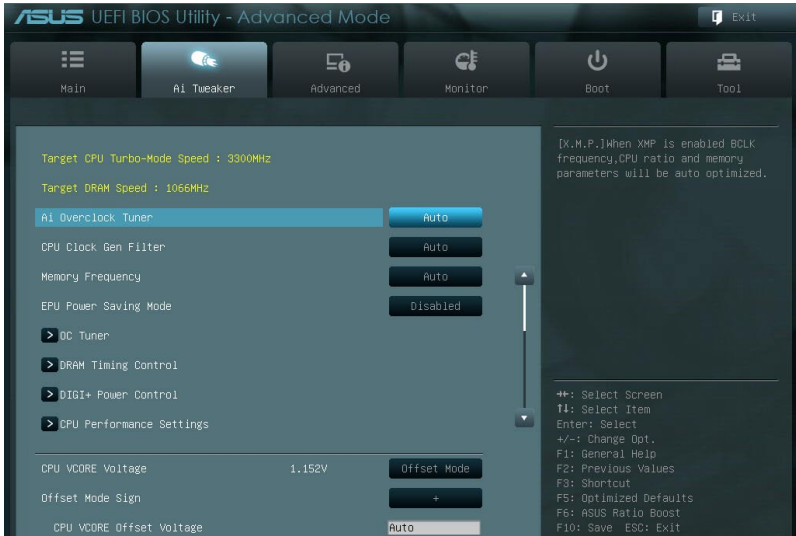

Scroll down to display the following items:

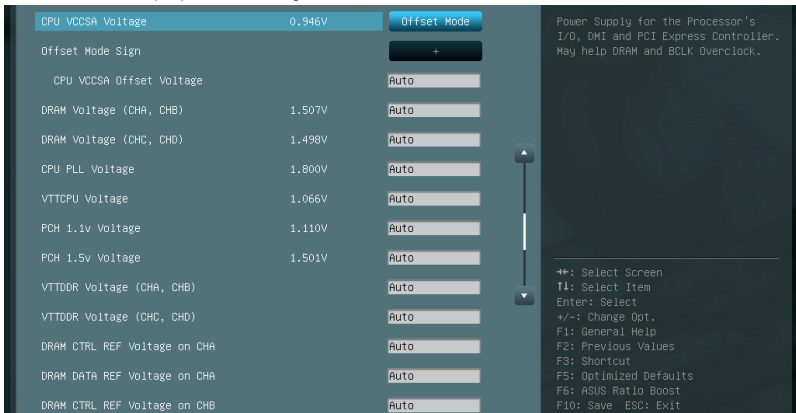

Scroll down to display the following items:

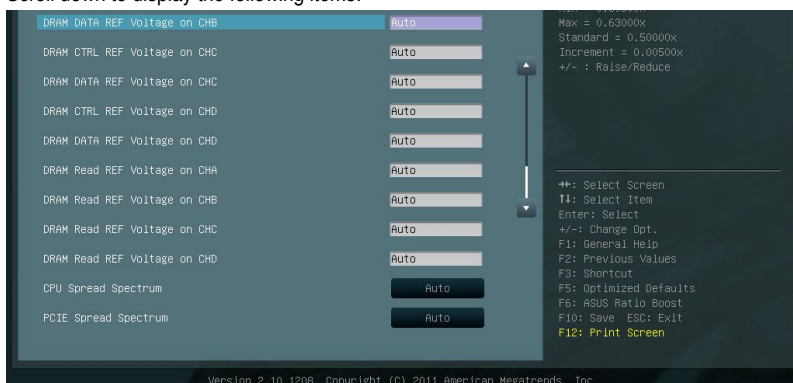

### Ai Overclock Tuner [Auto]

Allows you to select the CPU overclocking options to achieve the desired CPU internal frequency. Select any of these preset overclocking configuration options:

[Auto] Loads the optimal settings for the system.

[Manual] Allows you to individually set overclocking parameters.



The following three items appear only when you set the **Ai Overclocking Tuner** item to [Manual].

#### BCLK Frequency [XXX]

Allows you to adjust the CPU and VGA frequency to enhance the system performance. Use the <-> and <-> keys to adjust the value. You can also key in the desired value using the numeric keypad. The values range from 80.0MHz to 300.0MHz.

#### CPU Strap [Auto]

Configuration options: [Auto] [100MHz] [125MHz] [166MHz] [250MHz]

#### ClockGen Full Reset [Enabled]

[Enabled] Enabled for better overclocking.

[Disabled] To skip system shutdown at BCLK frequency adjustment.

### CPU Clock Gen Filter [Auto]

When enabled, this item may help maximize the CPU overclockability.

Configuration options: [Auto] [Enabled] [Disabled]

### Memory Frequency [Auto]

Forces a DDR3 frequency slower than the common tCK detected via SPD.

Configuration options: [Auto] [DDR3-800MHz] [DDR3-1066MHz] [DDR3-1333MHz] [DDR3-1600MHz] [DDR3-1866MHz] [DDR3-2133MHz] [DDR3-2400MHz] [DDR3-2666MHz]



Selecting a very high memory frequency may cause the system to become unstable! If this happens, revert to the default setting.

## EPU Power Saving Mode [Disabled]

Allows you to enable or disable the EPU power saving function.  
Configuration options: [Disabled] [Enabled]

## OC Tuner

OC Tuner automatically overlocks the frequency and voltage of CPU and DRAM for enhancing the system performance. Configuration options: [OK] [Cancel]

## DRAM Timing Control

The sub-items in this menu allow you to set the DRAM timing control features. Use the <+> and <-> keys to adjust the value. To restore the default setting, type [auto] using the keyboard and press the <Enter> key.



Changing the values in this menu may cause the system to become unstable! If this happens, revert to the default settings.

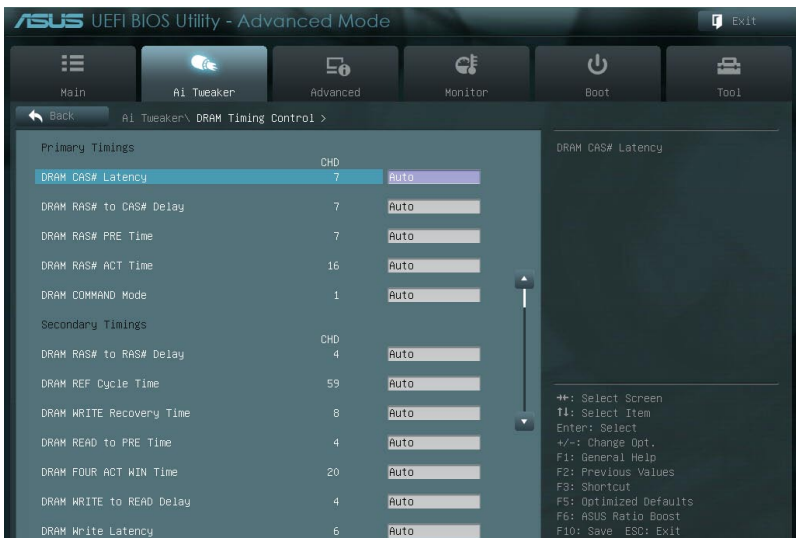

### Primary Timings

#### DRAM CAS# Latency [Auto]

Configuration options: [Auto] [3 DRAM Clock] – [15 DRAM Clock]

#### DRAM RAS# to CAS# Delay [Auto]

Configuration options: [Auto] [4 DRAM Clock] – [15 DRAM Clock]

#### DRAM RAS# PRE Time [Auto]

Configuration options: [Auto] [4 DRAM Clock] – [15 DRAM Clock]

#### DRAM RAS# ACT Time [Auto]

Configuration options: [Auto] [4 DRAM Clock] – [40 DRAM Clock]

DRAM COMMAND Mode [Auto]

Configuration options: [Auto] [1 DRAM Clock] [2 DRAM Clock] [3 DRAM Clock]

**Secondary Timings**

DRAM RAS# to RAS# Delay [Auto]

Configuration options: [Auto] [4 DRAM Clock] – [7 DRAM Clock]

DRAM REF Cycle Time [Auto]

Configuration options: [Auto] [48 DRAM Clock] – [511 DRAM Clock]

DRAM WRITE Recovery Time [Auto]

Configuration options: [Auto] [5 DRAM Clock] – [31 DRAM Clock]

DRAM READ to PRE Time [Auto]

Configuration options: [Auto] [4 DRAM Clock] – [15 DRAM Clock]

DRAM FOUR ACT WIN Time [Auto]

Configuration options: [Auto] [16 DRAM Clock] – [63 DRAM Clock]

DRAM WRITE to READ Delay [Auto]

Configuration options: [Auto] [4 DRAM Clock] – [15 DRAM Clock]

DRAM Write to Latency [Auto]

Configuration options: [Auto] [1 DRAM Clock] – [15 DRAM Clock]

**Third Timings**

tRRDR [Auto]

Configuration options: [Auto] [0 DRAM Clock] – [7 DRAM Clock]

tRRDD [Auto]

Configuration options: [Auto] [0 DRAM Clock] – [7 DRAM Clock]

tWWDR [Auto]

Configuration options: [Auto] [0 DRAM Clock] – [7 DRAM Clock]

tWWDD [Auto]

Configuration options: [Auto] [0 DRAM Clock] – [7 DRAM Clock]

tRWDR [Auto]

Configuration options: [Auto] [0 DRAM Clock] – [15 DRAM Clock]

tRWDD [Auto]

Configuration options: [Auto] [0 DRAM Clock] – [15 DRAM Clock]

tWRDR [Auto]

Configuration options: [Auto] [0 DRAM Clock] – [7 DRAM Clock]

tWRDD [Auto]

Configuration options: [Auto] [0 DRAM Clock] – [7 DRAM Clock]

tRWSR [Auto]

Configuration options: [Auto] [0 DRAM Clock] – [15 DRAM Clock]

tCCD [Auto]

Configuration options: [Auto] [0 DRAM Clock] – [7 DRAM Clock]



## Latency Timings

### DRAM RTL (CHA/B/C/D D0/1 R0/1 [Auto])

Configuration options: [Auto] [Advance 14 Clock] [Advance 12 Clock] – [Advance 4 Clock] [Advance 2 Clock] [Normal] [Delay 2 Clock] [Delay 4 Clock] – [Delay 12 Clock] [Delay 14 Clock]

### DRAM IOL (CHA/B/C/D D0/1 R0/1 [Auto])

Configuration options: [Auto] [Advance 14 Clock] – [Advance 1 Clock] [Normal] [Delay 1 Clock] – [Delay 14 Clock]

## others

### DRAM CLK Period [Auto]

Configuration options: [Auto] [1 DRAM Clock] – [8 DRAM Clock]

### Enhanced Training (CHA/B/C/D) [Auto]

Configuration options: [Auto] [Disabled] [Enabled]

### MCH Duty Sense (CHA/B/C/D) [Auto]

Configuration options: [Auto] [0 DRAM Clock] – [31 DRAM Clock]

### MCH Recheck [Auto]

Configuration options: [Auto] [Disabled] [Enabled]

## DIGI+ Power Control



Do not remove the thermal module while changing the DIGI+ Power Control related parameters . The thermal conditions should be monitored.

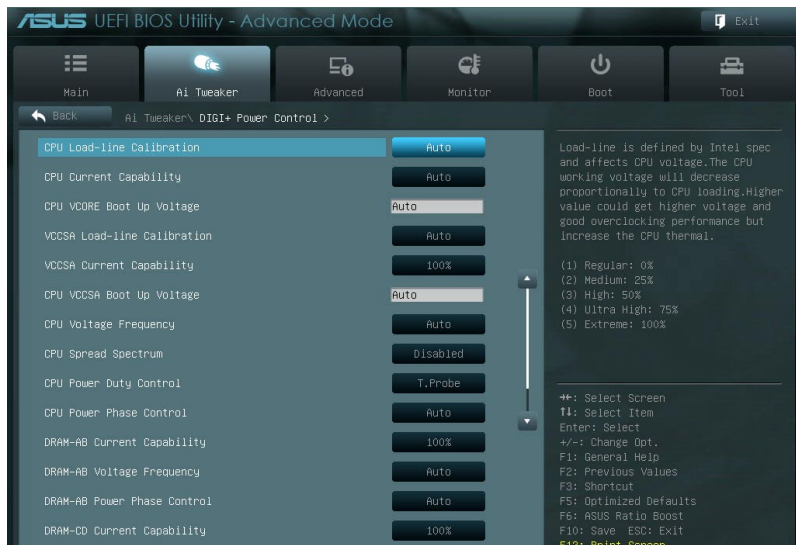



---

Some of the following items are adjusted by typing the desired values using the numeric keypad and press the <Enter> key. You can also use the <+> and <-> keys to adjust the value. To restore the default setting, type [auto] using the keyboard and press the <Enter> key.

---

#### CPU Load-Line Calibration [Auto]

CPU Load-line is defined by Intel VRM spec and affects CPU voltage. The CPU working voltage will decrease proportionally to CPU loading. Higher load-line calibration would get higher voltage and better overclocking performance, but increase the CPU and VRM thermal. This item allows you to adjust the voltage range from the following percentages to boost the system performance: 0% (Regular), 25% (Medium), 50% (High), 75% (Ultra High) and 100% (Extreme).

Configuration options: [Auto] [Regular] [Medium] [High] [Ultra High] [Extreme]

---



The actual performance boost may vary depending on your CPU specification.

---

#### CPU Current Capability [Auto]

This item provides wider total power range for overclocking. A higher value brings a wider total power range and extends the overclocking frequency range simultaneously.

Configuration options: [Auto] [100%] [110%] [120%] [130%] [140%]

---

#### CPU VCORE Boot Up Voltage [Auto]

This item controls the voltage for CPU at initial boot. Set higher value for better overclockability. The values range from 0.800V to 1.700V with a 0.005V interval.

---

#### VCCSA Load-line calibration [Auto]

The behavior of the DRAM controller is decided by VCCSA Load-Line. Set to a higher value for system performance, or to a lower value for better thermal solution.

Configuration options: [Auto] [Regular] [High] [Extreme]

---

#### VCCSA Current Capability [100%]

Allows you to set the VCCSA current capability. A higher value brings wider total DRAM controller power range and extends the overclocking frequency range simultaneously.

Configuration options: [100%] [110%] [120%] [130%]

---

#### CPU VCCSA Boot Up Voltage [Auto]

This item controls the voltage for CPU VCCSA at initial boot. Set higher value for better overclockability. The values range from 0.800V to 1.700V with a 0.005V interval.

---

#### CPU Voltage Frequency [Auto]

Switching frequency will affect the transient response and component thermal. Higher frequency gets quicker transient response.

Configuration options: [Auto] [Manual]

---

#### CPU Fixed Frequency [XXX]

This item appears only when you set the **CPU Voltage Frequency** item to [manual] and allows you to set a CPU fixed frequency. The values range from 300kHz to 500kHz with a 10kHz interval.

---

#### CPU Spread Spectrum [Disabled]

[Disabled] Enhances the BCLK overclocking ability.

[Enabled] Sets to [Enabled] for EMI control.

---

CPU Power Duty Control [T.Probe]

[T.Probe] Maintains the VRM thermal balance.

[Extreme] Maintains the VRM current balance.

CPU Power Phase Control [Auto]

Phase number is the number of working VRM phase. Increasing phase number under heavy system loading to get more transient and better thermal performance. Reducing phase number under light system loading to increase VRM efficiency

[Standard] Proceeds phase control depending on the CPU loading.

[Optimized] Loads the ASUS optimized phase tuning profile.

[Extreme] Proceeds the full phase mode.

[Manual Adjustment] Allows manual adjustment for Regular/Medium/Fast/Ultra Fast options.

DRAM-AB/DRAM-CD Current Capability [100%]

Setting a higher value brings a wider total power range and extends the overclocking frequency range simultaneously.

Configuration options: [100%] [110%] [120%] [130%]

DRAM-AB/DRAM-CD Voltage Frequency [Auto]

This item allows you to adjust the DRAM switching frequency. Assign a fixed high DRAM frequency to increase O.C range or a lower DRAM frequency for better system stability. Configuration options: [Auto] [manual]

DRAM-AB/DRAM-CD Fixed Frequency Mode [XXX]

This item appears only when you set the **DRAM-AB/DRAM-CD Voltage Frequency** item to [manual] and allows you to set a DRAM fixed frequency. The values range from 300kHz to 500kHz with a 50kHz interval.

DRAM-AB/DRAM-CD Power Phase control [Auto]

[Optimized] Allows you to set ASUS optimized phase tuning profile.

[Extreme] Allows you to set the Full phase mode.

## CPU Performance Settings

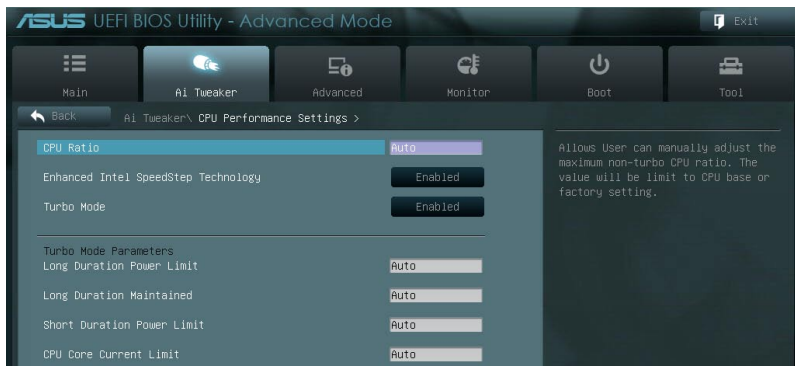

### CPU Ratio [Auto]

Allows you to manually adjust the maximum non-turbo CPU ratio. Use <+> and <-> keys to adjust the value. The valid value ranges vary according to your CPU model.

### Enhanced Intel SpeedStep Technology [Enabled]

Allows you to enable or disable the Enhanced Intel® SpeedStep Technology.

[Disabled] Disables this function.

[Enabled] The operating system dynamically adjusts the processor voltage and core frequency which may result in decreased average consumption and decreased average heat production.

### Turbo Mode [Enabled]

[Disabled] Disables this function.

[Enabled] Allows processor cores to run faster than marked frequency in specific condition.



---

The following items appear only when you set the **Turbo Mode** items to [Enabled].

---

## **Turbo Mode Parameters**

### Long Duration Power Limit [Auto]

The default setting of this item will be TDP (130W). For Sandy Bridge-E, Turbo Ratio can be kept a time duration exceed TDP for maximum performance. Any value under 255 can be programmed. Use the <+> and <-> keys to adjust the value.

### Long Duration Maintained [Auto]

This value can vary from 1 to 32, which indicates the time window for Turbo Ratio over TDP should be maintained. Use the <+> and <-> keys to adjust the value.

### Short Duration Power Limit [Auto]

This is the second power limit to provide rapid protection when package power exceeds Power Limit 1. Default setting is 1.25 times Power Limit 1. For Intel recommend, platform must be capable of supporting over Power Limit 2 for up to 10 msec. ASUS board can support over Power Limit 2 for a long duration. Use the <+> and <-> keys to adjust the value.

### Additional Turbo Voltage [Auto]

This item allows user to set the maximum additional voltage applied to the CPU when Turbo Boost is engaged. Use the <+> and <-> keys to adjust the value.

### CPU Core Current Limit [Auto]

This item allows user to enter CPU Current Limit, unit in 0.125A. Use the <+> and <-> keys to adjust the value.

## **CPU VCORE Voltage [Offset Mode]**

[Manual Mode] Allows you to set a fixed CPU voltage.

[Offset Mode] Allows you to set the Offset voltage.

### CPU VCORE Manual Voltage [Auto]

This item appears only when you set the **CPU VCORE Voltage** item to [Manual Mode] and allows you to set a fixed CPU voltage. The values range from 0.800V to 1.700V with a 0.005V interval.

### Offset Mode Sign [+]

This item appears only when you set the **CPU VCORE Voltage** item to [Offset Mode].

[+] To offset the voltage by a positive value.

[-] To offset the voltage by a negative value.

#### CPU VCORE Offset Voltage [Auto]

This item allows you to set the Offset voltage. The values range from 0.005V to 0.635V with a 0.005V interval.



Refer to the CPU documentation before setting the CPU voltage. Setting a high voltage may damage the CPU permanently, and setting a low voltage may make the system unstable.

### CPU VCCSA Voltage [Offset Mode]

[Manual Mode] Allows you to set a fixed CPU VCCSA voltage.

[Offset Mode] Allows you to set the CPU VCCSA Offset voltage.

#### CPU VCCSA Manual Voltage [Auto]

This item appears only when you set the **CPU VCCSA Voltage** item to [Manual Mode] and allows you to set a fixed CPU voltage. The values range from 0.800V to 1.700V with a 0.005V interval.

### Offset Mode Sign [+]

This item appears only when you set the **CPU VCCSA Voltage** item to [Offset Mode].

[+] To offset the voltage by a positive value.

[-] To offset the voltage by a negative value.

#### CPU VCCSA Offset Voltage [Auto]

This item allows you to set the Offset voltage. The values range from 0.005V to 0.635V with a 0.005V interval.

### DRAM Voltage (CHA, CHB) [Auto]

Allows you to set the DRAM voltage. The values range from 1.20V to 1.99V with a 0.005V interval.

### DRAM Voltage (CHC, CHD) [Auto]

Allows you to set the DRAM voltage. The values range from 1.20V to 1.99V with a 0.005V interval.



According to Intel CPU spec, DIMMs with voltage requirement over 1.65V may damage the CPU permanently. We recommend you install the DIMMs with the voltage requirement below 1.65V.

### CPU PLL Voltage [Auto]

Allows you to set the CPU and PCH PLL voltage. The values range from 1.80V to 2.10V with a 0.00625V interval.

### **VTTCPU Voltage [Auto]**

Allows you to set the VTTCPU voltage. The values range from 1.05V to 1.70V with a 0.00625V interval.

### **PCH 1.1v Voltage [Auto]**

Allows you to set the 1.1v Platform Controller Hub voltage. The values range from 1.10V to 1.70V with a 0.00625V interval.

### **PCH 1.5v Voltage [Auto]**

Allows you to set the 1.5v Platform Controller Hub voltage. The values range from 1.50V to 1.80V with a 0.00625V interval.

### **VTTDDR Voltage (CHA, CHB) [Auto]**

Allows you to set the CHA, CHB VTTDDR voltage. The values range from 0.6250V to 1.10V with a 0.00625V interval.

### **VTTDDR Voltage (CHC, CHD) [Auto]**

Allows you to set the CHC, CHD VTTDDR voltage. The values range from 0.6250V to 1.10V with a 0.00625V interval.

### **DRAM CTRL REF Voltage on CHA/B/C/D**

The values range from 0.3950x to 0.6300x with a 0.0050x interval.

### **DRAM DATA REF Voltage on CHA/B/C/D**

The values range from 0.3950x to 0.6300x with a 0.0050x interval.

### **DRAM Read REF Voltage on CHA/B/C/D**

The values range from 0.38500x to 0.61500x with a 0.0050x interval.

### **CPU Spread Spectrum [Auto]**

[Disabled] Enhances the BCLK overclocking ability.

[Enabled] Sets to [Enabled] for EMI control.

### **PCIe Spread Spectrum [Auto]**

[Disabled] Enhances the PCIe overclocking ability.

[Enabled] Sets to [Enabled] for EMI control.

## 3.5 Advanced menu

The Advanced menu items allow you to change the settings for the CPU and other system devices.



Be cautious when changing the settings of the Advanced menu items. Incorrect field values can cause the system to malfunction.

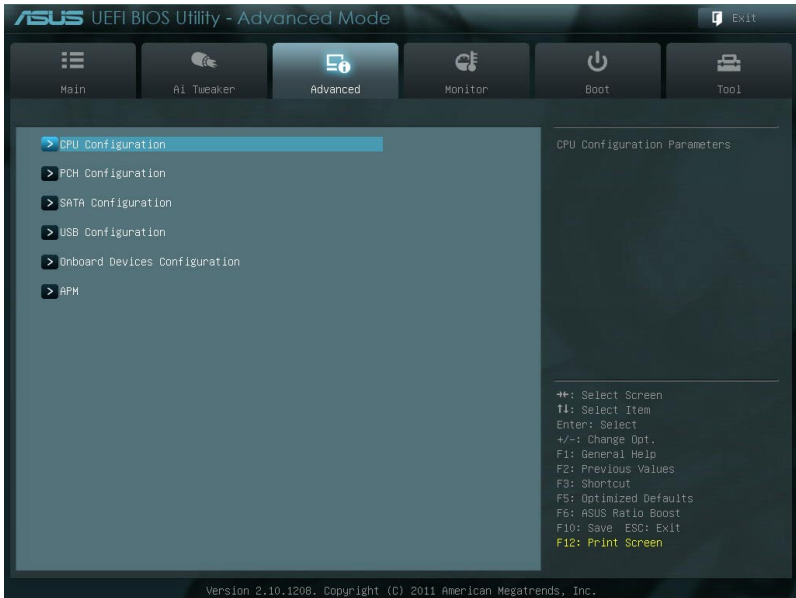

### 3.5.1 CPU Configuration

The items in this menu show the CPU-related information that the BIOS automatically detects.



The items shown in this screen may be different due to the CPU you installed.

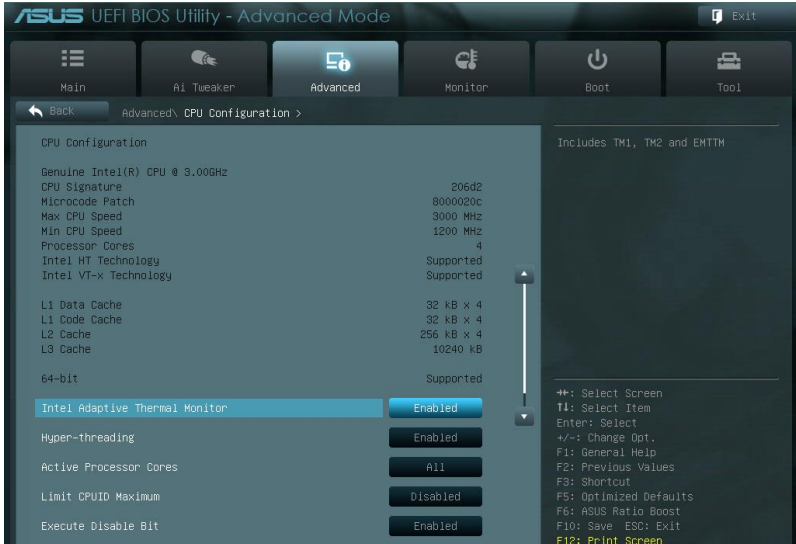

#### Intel Adaptive Thermal Monitor [Enabled]

[Disabled] Disables the CPU thermal monitor function.

[Enabled] Enables the overheated CPU to throttle its clock speed to cool down.

#### Hyper-threading [Enabled]

The Intel Hyper-Threading Technology allows a hyper-threading processor to appear as two logical processors to the operating system, allowing the operating system to schedule two threads or processes simultaneously.

[Disabled] Only one thread per activated core is enabled.

[Enabled] Two threads per activated core are enabled.

#### Active Processor Cores [All]

Allows you to choose the number of CPU cores to activate in each processor package. Configuration options: [All] or by CPU specification

#### Limit CPUID Maximum [Disabled]

[Enabled] Allows legacy operating systems to boot even without support for CPUs with extended CPUID functions.

[Disabled] For Windows® XP OS, select this option to disable this function.



**Execute Disable Bit [Enabled]**

- [Enabled] Enables the No-Execution Page Protection Technology.  
 [Disabled] Forces the XD feature flag to always return to zero (0).

**Intel Virtualization Tech [Enabled]**

- [Enabled] Allows a hardware platform to run multiple operating systems separately and simultaneously, enabling one system to virtually function as several systems.  
 [Disabled] Disables this function.

**CPU Power Management Configuration**CPU Ratio [Auto]

Allows you to set the ratio between the CPU Core Clock and the BCLK Frequency. Use <+> and <-> keys to adjust the ratio. The valid value ranges vary according to your CPU model.

Enhanced Intel SpeedStep Technology [Enabled]

- Allows you to enable or disable the Enhanced Intel® SpeedStep Technology (EIST).  
 [Disabled] The CPU runs at its default speed.  
 [Enabled] The operating system controls the CPU speed.

Turbo Mode [Enabled]

- [Disabled] Disables this function.  
 [Enabled] Allows processor cores to run faster than marked frequency in specific condition.

CPU C1E [Auto]

- [Disabled] Disables this function.  
 [Enabled] Enables the C1E support function. This item should be enabled in order to enable the Enhanced Halt State.

CPU C3 Report [Auto]

Allows you to disable or enable the CPU C3 report to OS.

CPU C6 Report [Auto]

Allows you to disable or enable the CPU C6 report to OS.

CPU C7 Report [Auto]

Allows you to disable or enable the CPU C7 report to OS.

### 3.5.2 PCH Configuration

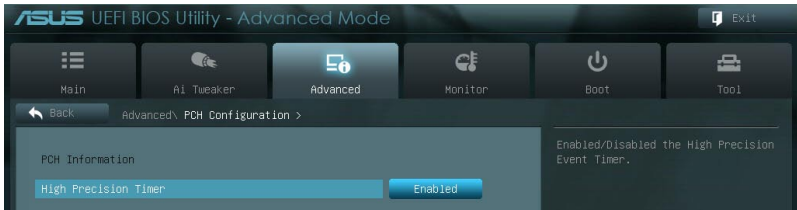

#### High Precision Timer [Enabled]

Allows you to enable or disable the High Precision Event Timer.  
Configuration options: [Disabled] [Enabled]

### 3.5.3 SATA Configuration

While entering Setup, the BIOS automatically detects the presence of SATA devices. The SATA Port items show **Not Present** if no SATA device is installed to the corresponding SATA port.

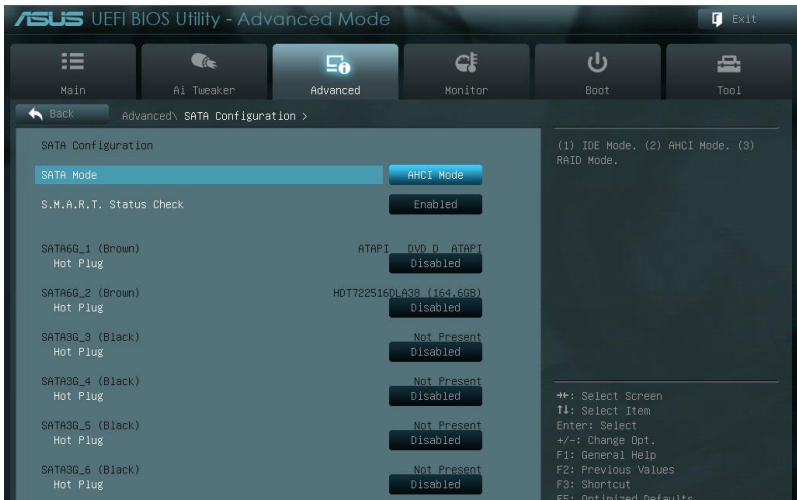

#### SATA Mode [AHCI Mode]

Allows you to set the SATA configuration.

- [Disabled] Disables the SATA function.
- [IDE Mode] Set to [IDE Mode] when you want to use the Serial ATA hard disk drives as Parallel ATA physical storage devices.
- [AHCI Mode] Set to [AHCI Mode] when you want the SATA hard disk drives to use the AHCI (Advanced Host Controller Interface). The AHCI allows the onboard storage driver to enable advanced Serial ATA features that increases storage performance on random workloads by allowing the drive to internally optimize the order of commands.
- [RAID Mode] Set to [RAID Mode] when you want to create a RAID configuration from the SATA hard disk drives.



---

The following two items appear only when you set the **SATA Mode** item to [IDE Mode].

---

### **Serial-ATA Controller 0 [Enhanced]**

Allows you to enable/disable the Serial-ATA Controller 0.

Configuration options: [Disabled] [Enhanced] [Compatible]

### **Serial-ATA Controller 1 [Enhanced]**

Allows you to enable/disable the Serial-ATA Controller 1.

Configuration options: [Disabled] [Enhanced]

### **S.M.A.R.T. Status Check [Enabled]**

S.M.A.R.T. (Self-Monitoring, Analysis and Reporting Technology) is a monitor system. When read/write of your hard disk errors occur, this feature allows the hard disk to report warning messages during the POST. Configuration options: [Enabled] [Disabled]

### **Hot Plug [Disabled]**

These items appear only when you set the **SATA Mode** item to [AHCI Mode] or [RAID Mode] and allow you to enable/disable SATA Hot Plug Support.

Configuration options: [Disabled] [Enabled].

### 3.5.4 USB Configuration

The items in this menu allow you to change the USB-related features.

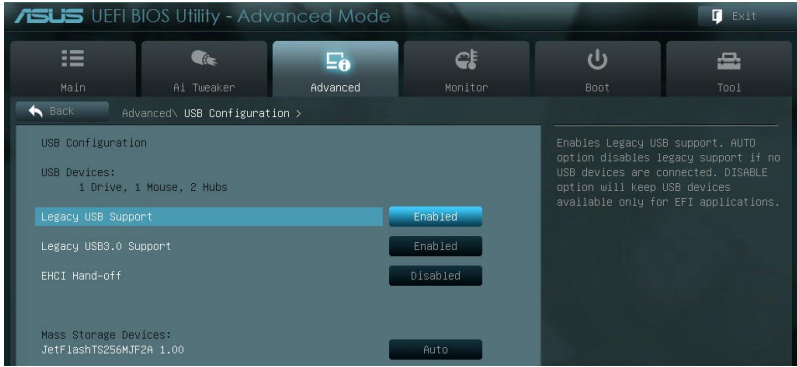

The **USB Devices** item shows the auto-detected values. If no USB device is detected, the item shows **None**.

#### Legacy USB Support [Enabled]

- [Disabled] The USB devices can be used only for the BIOS setup program.
- [Enabled] Enables the support for USB devices on legacy operating systems (OS).
- [Auto] Allows the system to detect the presence of USB devices at startup. If detected, the USB controller legacy mode is enabled. If no USB device is detected, the legacy USB support is disabled.

#### Legacy USB3.0 Support [Enabled]

- [Disabled] Disables the function.
- [Enabled] Enables the support for USB 3.0 devices on legacy operating systems (OS).

#### EHCI Hand-off [Disabled]

- [Disabled] Disables the function.
- [Enabled] Enables the support for operating systems without an EHCI hand-off feature.

## 3.5.5 Onboard Devices Configuraton

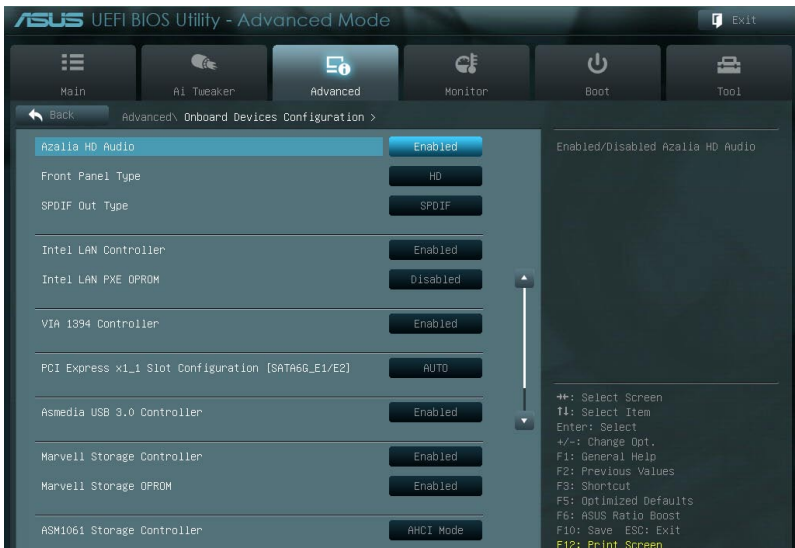

### Azalia HD Audio [Enabled]

[Disabled] Disables the controller.

[Enabled] Enables the High Definition Audio Controller.



The following two items appear only when you set the **HD Audio Controller** item to [Enabled].

### Front Panel Type [HD]

Allows you to set the front panel audio connector (AAFP) mode to legacy AC'97 or high-definition audio depending on the audio standard that the front panel audio module supports.

[HD] Sets the front panel audio connector (AAFP) mode to high definition audio.

[AC97] Sets the front panel audio connector (AAFP) mode to legacy AC'97

### SPDIF Out Type [SPDIF]

[SPDIF] Sets to [SPDIF] for SPDIF audio output.

[HDMI] Sets to [HDMI] for HDMI audio output.

### Intel LAN Controller [Enabled]

[Disabled] Disables the controller.

[Enabled] Enables the Intel LAN controller.

### Intel PXE OPRM [Disabled]

This item appears only when you set the previous item to [Enabled] and allows you to enable or disable the PXE OptionRom of the Intel LAN controller.

Configuration options: [Enabled] [Disabled]

### VIA 1394 Controller [Enabled]

This item allows user to enabled/disabled VIA 1394 controller.

Configuration options: [Disabled] [Enabled]

### PCI Express x1\_1 Slot Configuration [Auto]

[AUTO] The system auto-detects the occupied PCIe<sub>x1\_1</sub> slot or SATA6G\_E1/E2 connector. When both are occupied, only PCIe<sub>x1\_1</sub> slot can work.

[SATA6G\_E1/E2] If SATA6G\_E1/E2 (Marvell controller) is enabled, PCIe<sub>x1\_1</sub> slot will be blocked and you can connect devices to the SATA6G\_E1/E2 connector.

### Asmedia USB 3.0 Controller [Enabled]

This item allows user to enabled/disabled Asmedia USB 3.0.

Configuration options: [Disabled] [Enabled]

### Marvell Storage Controller [Enabled]

Allows you to select the Marvell storage controller operating mode.

[Disabled] Disables the controller.

[Enabled] Set to [Enabled] when you want use the function of Marvell RAID.

### Marvell Storage OPROM [Enabled]

This item appears only when you set the previous item to [Enabled] and allows you to enable or disable the OptionRom of the Marvell storage controller.

Configuration options: [Disabled] [Enabled]

### ASM1061 Storage Controller [AHCI Mode]

Allows you to enable or disable the ASM1061 storage controller.

Configuration options: [Disabled] [IDE Mode] [AHCI Mode]



---

If you want to use the full functin of the ASM1061 storage contorller (ex. AHCI), we recommend that you set this item to [AHCI Mode] and install the **ASM1061 Controller Driver** from the motherboard support DVD.

---

### ASM1061 Storage OPROM [Enabled]

This item appears only when you set the previous item to [IDE Mode] or [AHCI Mode] and allows you to enable or disable the OptionRom of the ASM1061 storage controller.

Configuration options: [Disabled] [Enabled]

### Serial Port Configuration

#### *Serial Port [Enabled]*

Allows you to enable or disable the serial port (COM).

Configuration options: [Enabled] [Disabled]

#### *Change Settings [IO=3F8h; IRQ=4]*

Allows you to select the Serial Port base address.

Configuration options: [IO=3F8h; IRQ=4] [IO=2F8h; IRQ=3] [IO=3E8h; IRQ=4] [IO=2E8h; IRQ=3]

## 3.5.6 APM

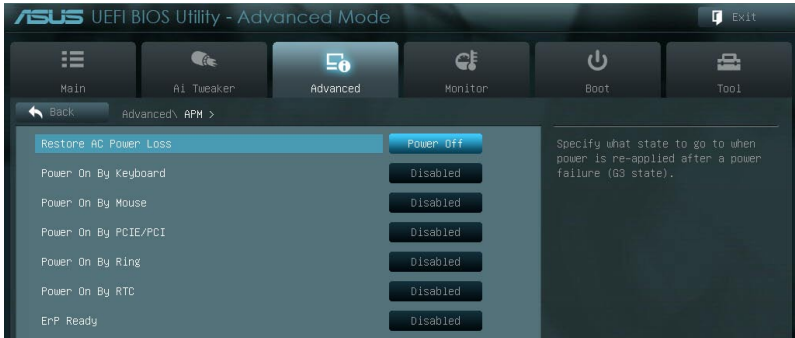

### Restore AC Power Loss [Power Off]

[Power On] The system goes into on state after an AC power loss.

[Power Off] The system goes into off state after an AC power loss.

[Last State] The system goes into either off or on state, whatever the system state was before the AC power loss.

### Power On By Keyboard [Disabled]

Allows you to disable the Power On by keyboard function or set specific keys on the keyboard to turn on the system.

Configuration options: [Disabled] [Space Bar] [Ctrl-Esc] [Power Key]

### Power On By Mouse [Disabled]

[Disabled] Disables the Power On by a mouse.

[Enabled] Enables the Power On by a mouse.

### Power On By PCIE/PCI [Disabled]

[Disabled] Disables the PCIE devices to generate a wake event.

[Enabled] Enables the PCIE devices to generate a wake event.

### Power On By Ring [Disabled]

[Disabled] Disables Ring to generate a wake event.

[Enabled] Enables Ring to generate a wake event.

### Power On By RTC [Disabled]

[Disabled] Disables RTC to generate a wake event.

[Enabled] When set to [Enabled], the items **RTC Alarm Date (Days)** and **Hour/Minute/Second** will become user-configurable with set values.

### ErP Ready [Disabled]

This item allows user to switch off some power at S5 to get the system ready for ErP requirement. When set to Enabled, all other PME options will be switched off.

Configuration options: [Disabled] [Enabled]

## 3.6 Monitor menu

The Monitor menu displays the system temperature/power status, and allows you to change the fan settings.

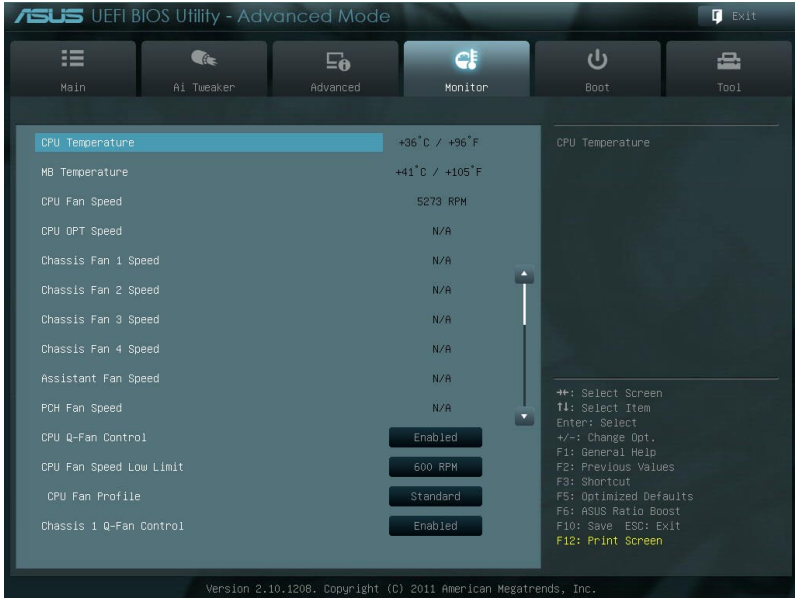

### CPU Temperature / MB Temperature [xxx°C/xxx°F]

The onboard hardware monitor automatically detects and displays the CPU and motherboard temperatures. Select **Ignore** if you do not wish to display the detected temperatures.

### CPU Fan Speed; CPU OPT Fan Speed; Chassis Fan 1/2/3/4 Speed; Assistant Fan Speed; PCH Fan Speed [xxxx RPM] or [Ignore] / [N/A]

The onboard hardware monitor automatically detects and displays the CPU fan, CPU OPT fan, chassis fan, assistant fan, and PCH fan speed in rotations per minute (RPM). If the fan is not connected to the motherboard, the field shows **N/A**. Select **Ignore** if you do not wish to display the detected speed.

### CPU Q-Fan Control [Enabled]

[Disabled] Disables the CPU Q-Fan control feature.

[Enabled] Enables the CPU Q-Fan control feature.

### CPU Fan Speed Low Limit [600 RPM]

This item appears only when you enable the **CPU Q-Fan Control** feature and allows you to disable or set the CPU fan warning speed.

Configuration options: [Ignore] [200 RPM] [300 RPM] [400 RPM] [500 RPM] [600 RPM]



### CPU Fan Profile [Standard]

This item appears only when you enable the **CPU Q-Fan Control** feature and allows you to set the appropriate performance level of the CPU fan.

- [Standard] Sets to [Standard] to make the CPU fan automatically adjust depending on the CPU temperature.
- [Silent] Sets to [Silent] to minimize the fan speed for quiet CPU fan operation.
- [Turbo] Sets to [Turbo] to achieve maximum CPU fan speed.
- [Manual] Sets to [Manual] to assign detailed fan speed control parameters.



---

The following four items appear only when you set **CPU Fan Profile** to [Manual].

---

#### CPU Upper Temperature [70]

Use the <+> and <-> keys to adjust the upper limit of the CPU temperature. The values range from 20°C to 75°C.

#### CPU Fan Max. Duty Cycle(%) [100]

Use the <+> and <-> keys to adjust the maximum CPU fan duty cycle. The values range from 0% to 100%. The minimum value can not lower than the setting of Min duty cycle. When the CPU temperature reaches 75 degree, fan will run up to full speed.

#### CPU Lower Temperature [20]

Displays the lower limit of the CPU temperature.

#### CPU Fan Min. Duty Cycle(%) [20]

Use the <+> and <-> keys to adjust the minimum CPU fan duty cycle. The values range from 0% to 100%. When the CPU temperature is under 40°C, the CPU fan will operate at the minimum duty cycle.

### **Chassis 1/2/3/4 Q-Fan Control [Enabled]**

[Disabled] Disables the Chassis Q-Fan control feature.

[Enabled] Enables the Chassis Q-Fan control feature.

### **Chassis 1/2/3/4 Fan Speed Low Limit [600 RPM]**

This item appears only when you enable the **Chassis 1/2/3/4 Q-Fan Control** feature and allows you to disable or set the chassis fan warning speed.

Configuration options: [Ignore] [200 RPM] [300 RPM] [400 RPM] [500 RPM] [600 RPM]

### Chassis 1/2/3/4 Fan Profile [Standard]

This item appears only when you enable the **Chassis Q-Fan Control** feature and allows you to set the appropriate performance level of the chassis fan.

- [Standard] Sets to [Standard] to make the chassis fan automatically adjust depending on the chassis temperature.
- [Silent] Sets to [Silent] to minimize the fan speed for quiet chassis fan operation.
- [Turbo] Sets to [Turbo] to achieve maximum chassis fan speed.
- [Manual] Sets to [Manual] to assign detailed fan speed control parameters.



---

The following four items appear only when you set **Chassis 1/2/3/4 Fan Profile** to [Manual].

---

**Chassis 1/2/3/4 Upper Temperature [70]**

Use the <+> and <-> keys to adjust the upper limit of the chassis temperature. The values range from 40°C to 90°C.

**Chassis 1/2/3/4 Fan Max. Duty Cycle(%) [100]**

Use the <+> and <-> keys to adjust the maximum chassis fan duty cycle. The values range from 60% to 100%. The minimum value can not lower than the setting of Min duty cycle. When the chassis temperature reaches 95 degree, fan will run up to full speed.

**Chassis 1/2/3/4 Lower Temperature [40]**

Displays the lower limit of the chassis temperature.

**Chassis 1/2/3/4 Fan Min. Duty Cycle(%) [60]**

Use the <+> and <-> keys to adjust the minimum chassis fan duty cycle. The values range from 60% to 100%. When the chassis temperature is under 40°C, the chassis fan will operate at the minimum duty cycle.

### **Assistant/PCH Q-Fan Control [Enabled]**

[Disabled] Disables the Assistant / PCH Q-Fan control feature.

[Enabled] Enables the Assistant / PCH Q-Fan control feature.

### **Assistant/PCH Fan Speed Low Limit [600 RPM]**

This item appears only when you enable the **Assistant/PCH Q-Fan Control** feature and allows you to disable or set the chassis fan warning speed.

Configuration options: [Ignore] [200 RPM] [300 RPM] [400 RPM] [500 RPM] [600 RPM]

*Assistant/PCH Fan Profile [Standard]*

This item appears only when you enable the **Assistant/PCH Q-Fan Control** feature and allows you to set the appropriate performance level of the assistant/PCH fan.

[Standard] Sets to [Standard] to make the assistant/PCH fan automatically adjust depending on the assistant/PCH temperature.

[Silent] Sets to [Silent] to minimize the fan speed for quiet assistant/PCH fan operation.

[Turbo] Sets to [Turbo] to achieve maximum assistant/PCH fan speed.

[Manual] Sets to [Manual] to assign detailed fan speed control parameters.



---

The following four items appear only when you set **Assistant/PCH Fan Profile** to [Manual].

---

**Assistant/PCH Upper Temperature [70]**

Use the <+> and <-> keys to adjust the upper limit of the assistant/PCH temperature. The values range from 40°C to 90°C.

**Assistant/PCH Fan Max. Duty Cycle(%) [100]**

Use the <+> and <-> keys to adjust the maximum assistant/PCH fan duty cycle. The values range from 60% to 100%. The minimum value can not lower than the setting of Min duty cycle. When the assistant/PCH temperature reaches 95 degree, fan will run up to full speed.

Assistant/PCH Lower Temperature [40]

Displays the lower limit of the assistant/PCH temperature.

Assistant/PCH Fan Min. Duty Cycle(%) [60]

Use the <+> and <-> keys to adjust the minimum assistant/PCH fan duty cycle. The values range from 60% to 100%. When the assistant/PCH temperature is under 40°C, the assistant/PCH fan will operate at the minimum duty cycle.

### **CPU Voltage, 3.3V Voltage, 5V Voltage, 12V Voltage**

The onboard hardware monitor automatically detects the voltage output through the onboard voltage regulators. Select **Ignore** if you do not want to detect this item.

### **Anti Surge Support [Enabled]**

This item allows you to enable or disable the Anti Surge function.

Configuration options: [Disabled] [Enabled]

## 3.7 Boot menu

The Boot menu items allow you to change the system boot options.

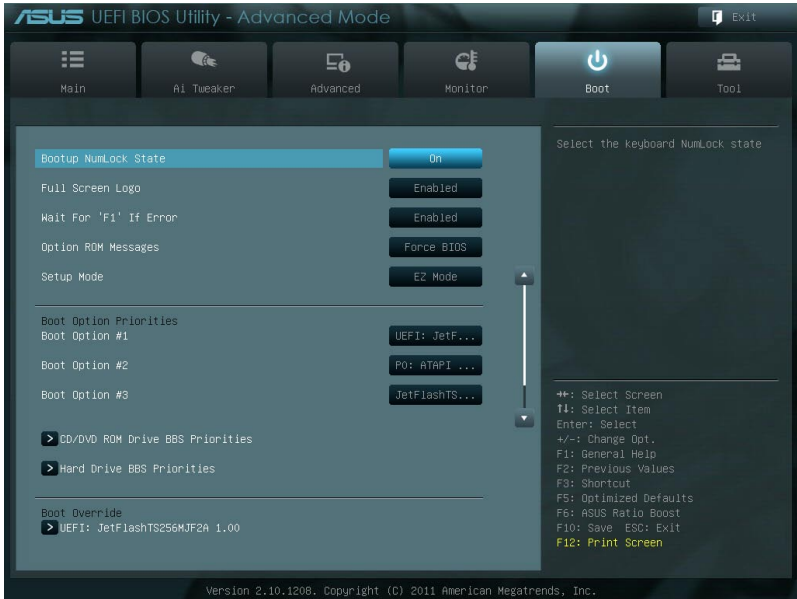

### Bootup NumLock State [On]

[On] Sets the power-on state of the NumLock to [On].

[Off] Sets the power-on state of the NumLock to [Off].

### Full Screen Logo [Enabled]

[Enabled] Enables the full screen logo display feature.

[Disabled] Disables the full screen logo display feature.



Set this item to [Enabled] to use the ASUS MyLogo 2™ feature.

### Wait For 'F1' If Error [Enabled]

[Disabled] Disables this function.

[Enabled] The system waits for the <F1> key to be pressed when error occurs.

### Option ROM Messages [Force BIOS]

[Force BIOS] The third-party ROM messages will be forced to display during the boot sequence.

[Keep Current] The third-party ROM messages will be displayed only if the third-party manufacturer had set the add-on device to do so.

## Setup Mode [EZ Mode]

[Advanced Mode] Sets Advanced Mode as the default screen for entering the BIOS setup program.

[EZ Mode] Sets EZ Mode as the default screen for entering the BIOS setup program.

## Boot Option Priorities

These items specify the boot device priority sequence from the available devices. The number of device items that appears on the screen depends on the number of devices installed in the system.



- 
- To select the boot device during system startup, press <F8> when ASUS Logo appears.
  - To access Windows OS in Safe Mode, press <F8> after POST.
- 

## Boot Override

These items displays the available devices. The number of device items that appears on the screen depends on the number of devices installed in the system. Click an item to start booting from the selected device.

## 3.8 Tool menu

The Tool menu items allow you to configure options for special functions. Select an item then press <Enter> to display the submenu.

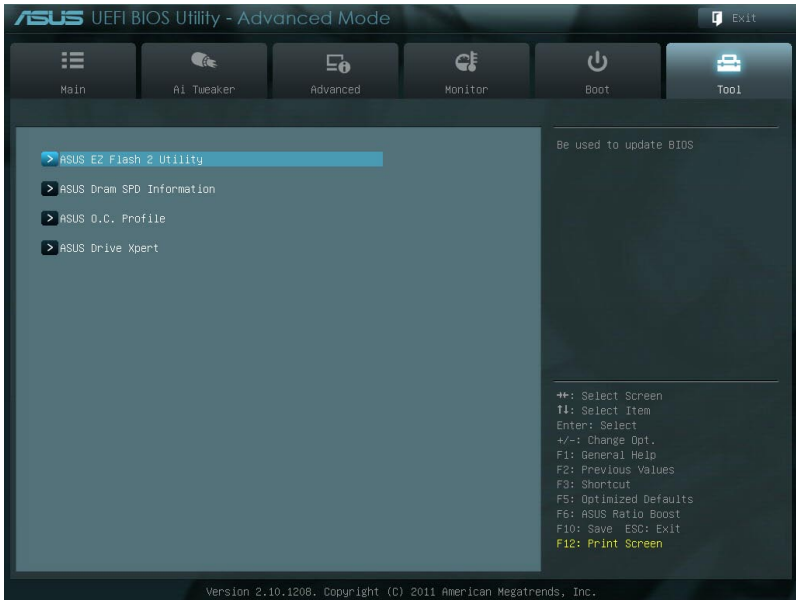

### 3.8.1 ASUS EZ Flash 2 Utility

Allows you to run ASUS EZ Flash 2 Utility. When you press <Enter>, a confirmation message appears. Use the left/right arrow key to select between [Yes] or [No], then press <Enter> to confirm your choice.



---

For more details, refer to **section 3.10.2 ASUS EZ Flash 2 utility**.

---

### 3.8.2 ASUS DRAM SPD Information

This menu showed the DIMM slot related informations.

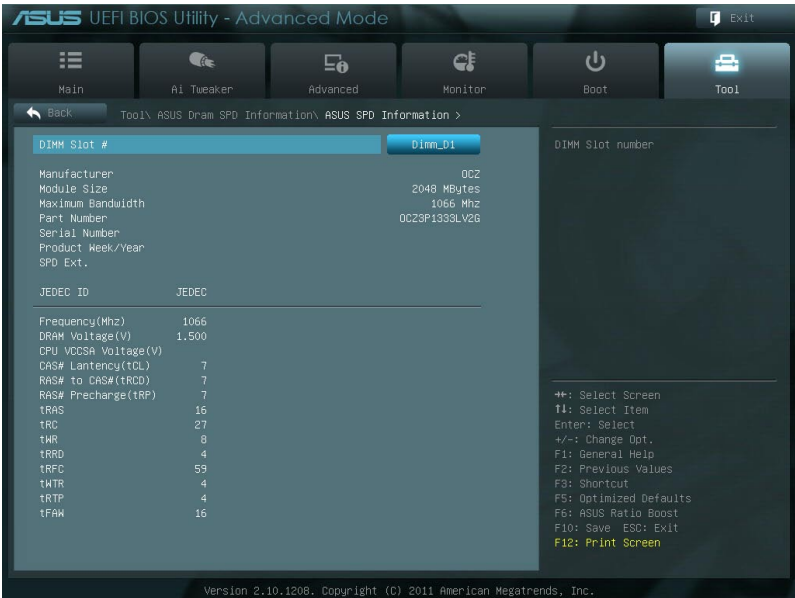
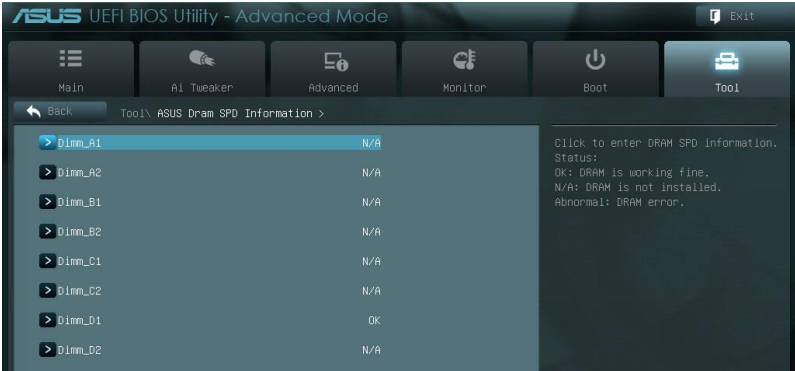

### 3.8.3 ASUS O.C. Profile

This item allows you to store or load multiple BIOS settings.

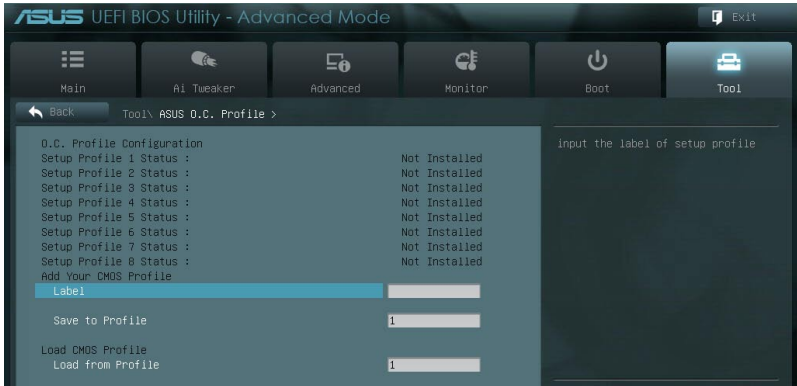

The **Setup Profile Status** items show **Not Installed** if no profile is created.

#### Label

Allows you to input the label of setup profile.

#### Save to Profile

Allows you to save the current BIOS settings to the BIOS Flash, and create a profile. Key in a profile number from one to eight, press <Enter>, and then select **Yes**.

#### Load from Profile

Allows you to load the previous BIOS settings saved in the BIOS Flash. **Key in the profile number** that saved your BIOS settings, press <Enter>, and then select **Yes**.



- DO NOT shut down or reset the system while updating the BIOS to prevent the system boot failure!
- We recommend that you update the BIOS file only coming from the same memory/CPU configuration and BIOS version.



### 3.8.4 ASUS Drive Xpert

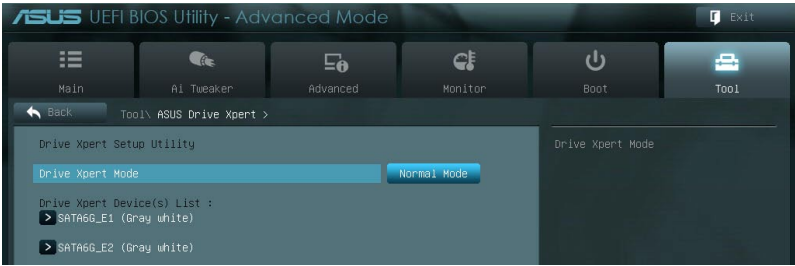

- Before using the Drive Xpert function, ensure that you have connected the SATA signal cables and installed SATA hard disk drives to the **SATA6G\_E1** and **SATA6G\_E2** connectors.
- You can only make one Drive Xpert change a time before you save BIOS settings and restart the computer.

#### Drive Xpert Mode

- [Normal Mode] Allows you to use the SATA6G\_E1 and SATA6G\_E2 connectors as normal SATA connectors.
- [Super Speed] Allows you to use the **Super Speed** function that combines two hard drives as one single drive partition.
- [EZ Backup] Allows you to use the **EZ Backup** function that copies and maintains an identical image of data from the SATA6G\_E1 drive to the SATA6G\_E2 drive.



When using only one hard disk in **Normal Mode**, connect the hard disk to the SATA6G\_E1 connector on the motherboard.



- All original data of the two hard drives will be erased for Super Speed setup.
- All original data of the SATA6G\_E2 hard disk will be erased for EZ Backup setup.

#### Drive Xpert Device(s) List:

*SATA 6G E1 (Gray white) / SATA 6G E2 (Gray white)*

Press <Enter> to display the information of the hard disks which are connected to the SATA6G\_E1 and SATA6G\_E2 connectors on the motherboard.

## 3.9 Exit menu

The Exit menu items allow you to load the optimal default values for the BIOS items, and save or discard your changes to the BIOS items. You can access the **EZ Mode** from the Exit menu.

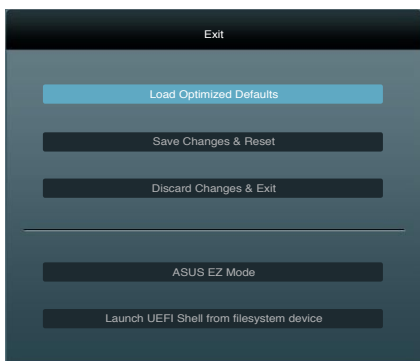

### Load Optimized Defaults

This option allows you to load the default values for each of the parameters on the Setup menus. When you select this option or if you press <F5>, a confirmation window appears. Select **Yes** to load the default values.

### Save Changes & Reset

Once you are finished making your selections, choose this option from the Exit menu to ensure the values you selected are saved. When you select this option or if you press <F10>, a confirmation window appears. Select **Yes** to save changes and exit.

### Discard Changes & Exit

This option allows you to exit the Setup program without saving your changes. When you select this option or if you press <Esc>, a confirmation window appears. Select **Yes** to discard changes and exit.

### ASUS EZ Mode

This option allows you to enter the EZ Mode screen.

### Launch UEFI Shell from filesystem device

This option allows you to attempt to launch the UEFI Shell application (shellx64.efi) from one of the available filesystem devices.

## 3.10 Updating BIOS

The ASUS website publishes the latest BIOS versions to provide enhancements on system stability, compatibility, or performance. However, BIOS updating is potentially risky. If there is no problem using the current version of BIOS, **DO NOT manually update the BIOS**. Inappropriate BIOS updating may result in the system's failure to boot. Carefully follow the instructions of this chapter to update your BIOS if necessary.



---

Visit the ASUS website ([www.asus.com](http://www.asus.com)) to download the latest BIOS file for this motherboard.

---

The following utilities allow you to manage and update the motherboard BIOS setup program.

1. **ASUS Update:** Updates the BIOS in Windows® environment.
2. **ASUS EZ Flash 2:** Updates the BIOS using a USB flash drive.
3. **ASUS CrashFree BIOS 3:** Restores the BIOS using the motherboard support DVD or a USB flash drive when the BIOS file fails or gets corrupted.
4. **ASUS BIOS Updater:** Updates and backups the BIOS in DOS environment using the motherboard support DVD and a USB flash disk drive.

Refer to the corresponding sections for details on these utilities.



---

Save a copy of the original motherboard BIOS file to a USB flash disk in case you need to restore the BIOS in the future. Copy the original motherboard BIOS using the **ASUS Update** or **BIOS Updater** utilities.

---

### 3.10.1 ASUS Update utility

The ASUS Update is a utility that allows you to manage, save, and update the motherboard BIOS in Windows® environment. The ASUS Update utility allows you to:

- Update the BIOS directly from the Internet
- Download the latest BIOS file from the Internet
- Update the BIOS from an updated BIOS file
- Save the current BIOS file
- View the BIOS version information

This utility is available in the support DVD that comes with the motherboard package.



---

ASUS Update requires an Internet connection either through a network or an Internet Service Provider (ISP).

---

#### Launching ASUS Update

After installing AI Suite II from the motherboard support DVD, launch ASUS Update by clicking **Update > ASUS Update** on the AI Suite II main menu bar.



---

Quit all Windows® applications before you update the BIOS using this utility.

---

## Updating the BIOS through the Internet

To update the BIOS through the Internet:

1. From the ASUS Update screen, select **Update BIOS from Internet**, and then click **Next**.



2. Select the ASUS FTP site nearest you to avoid network traffic.  
If you want to enable the BIOS downgradable function and auto BIOS backup function, check the checkboxes before the two items on the screen.



3. Select the BIOS version that you want to download. Click **Next**.



4. You can decide whether to change the BIOS boot logo, which is the image appearing on screen during the Power-On Self-Tests (POST). Click **Yes** if you want to change the boot logo or **No** to continue.
5. Follow the onscreen instructions to complete the update process.



## Updating the BIOS through a BIOS file

To update the BIOS through a BIOS file:

1. From the ASUS Update screen, select **Update BIOS from file**, and then click **Next**.



2. Locate the BIOS file from the Open window, click **Open**, and click **Next**.



3. You can decide whether to change the BIOS boot logo. Click **Yes** if you want to change the boot logo or **No** to continue.
4. Follow the onscreen instructions to complete the update process.



- The screenshots in this section are for reference only. The actual BIOS information vary by models.
- Refer to the software manual in the support DVD or visit the ASUS website at [www.asus.com](http://www.asus.com) for detailed software configuration.

### 3.10.2 ASUS EZ Flash 2 utility

The ASUS EZ Flash 2 feature allows you to update the BIOS without having to use a bootable floppy disk or an OS-based utility.



Before you start using this utility, download the latest BIOS from the ASUS website at [www.asus.com](http://www.asus.com).

To update the BIOS using EZ Flash 2:

1. Insert the USB flash disk that contains the latest BIOS file to the USB port.
2. Enter the Advanced Mode of the BIOS setup program. Go to the **Tool** menu to select **ASUS EZ Flash Utility** and press <Enter> to enable it.

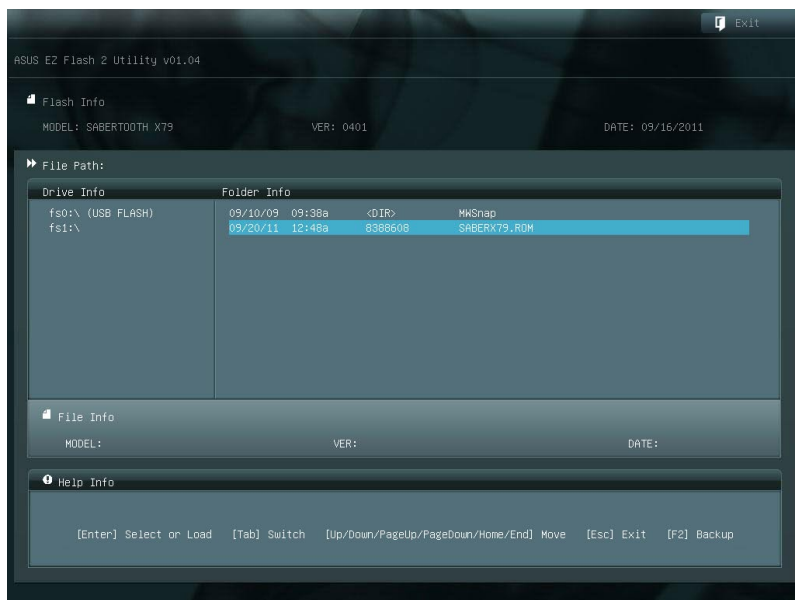

3. Press <Tab> to switch to the **Drive** field.
4. Press the Up/Down arrow keys to find the USB flash disk that contains the latest BIOS, and then press <Enter>.
5. Press <Tab> to switch to the **Folder Info** field.
6. Press the Up/Down arrow keys to find the BIOS file, and then press <Enter> to perform the BIOS update process. Reboot the system when the update process is done.



- 
- This function can support devices such as a USB flash disk with FAT 32/16 format and single partition only.
  - DO NOT shut down or reset the system while updating the BIOS to prevent system boot failure!
- 



---

Ensure to load the BIOS default settings to ensure system compatibility and stability. Select the **Load Optimized Defaults** item under the **Exit** menu. See section **3.9 Exit Menu** for details.

---

### 3.10.3 ASUS CrashFree BIOS 3 utility

The ASUS CrashFree BIOS 3 utility is an auto recovery tool that allows you to restore the BIOS file when it fails or gets corrupted during the updating process. You can restore a corrupted BIOS file using the motherboard support DVD or a USB flash drive that contains the BIOS file.



---

The BIOS file in the motherboard support DVD may be older than the BIOS file published on the ASUS official website. If you want to use the newer BIOS file, download the file at [support.asus.com](http://support.asus.com) and save it to a USB flash drive.

---

## Recovering the BIOS

To recover the BIOS:

1. Turn on the system.
2. Insert the motherboard support DVD to the optical drive, or the USB flash drive containing the BIOS file to the USB port.
3. The utility automatically checks the devices for the BIOS file. When found, the utility reads the BIOS file and enters ASUS EZ Flash 2 utility automatically.
4. The system requires you to enter BIOS Setup to recover BIOS setting. To ensure system compatibility and stability, we recommend that you press <F5> to load default BIOS values.



---

DO NOT shut down or reset the system while updating the BIOS! Doing so can cause system boot failure!

---

### 3.10.4 ASUS BIOS Updater

The ASUS BIOS Updater allows you to update BIOS in DOS environment. This utility also allows you to copy the current BIOS file that you can use as a backup when the BIOS fails or gets corrupted during the updating process.



The succeeding utility screens are for reference only. The actual utility screen displays may not be same as shown.

#### Before updating BIOS

1. Prepare the motherboard support DVD and a USB flash drive in FAT32/16 format and single partition.
2. Download the latest BIOS file and BIOS Updater from the ASUS website at <http://support.asus.com> and save them on the USB flash drive.



- NTFS is not supported under DOS environment. Do not save the BIOS file and BIOS Updater to a hard disk drive or USB flash drive in NTFS format.
- Do not save the BIOS file to a floppy disk due to low disk capacity.

3. Turn off the computer and disconnect all SATA hard disk drives (optional).

#### Booting the system in DOS environment

1. Insert the USB flash drive with the latest BIOS file and BIOS Updater to the USB port.
2. Boot your computer. When the ASUS Logo appears, press <F8> to show the **BIOS Boot Device Select Menu**. Insert the support DVD into the optical drive and select the optical drive as the boot device.

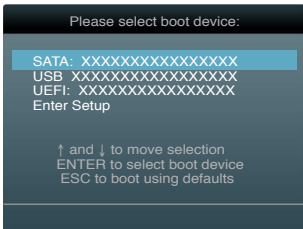

3. When the **Make Disk** menu appears, select the **FreeDOS command prompt** item by pressing the item number.
4. At the FreeDOS prompt, type `d:` and press <Enter> to switch the disk from Drive C (optical drive) to Drive D (USB flash drive).

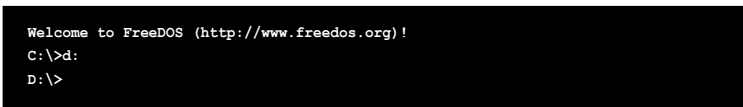



## Backing up the current BIOS

To backup the current BIOS file using the BIOS Updater



Ensure that the USB flash drive is not write-protected and has enough free space to save the file.

1. At the FreeDOS prompt, type `bupdater /o [filename]` and press <Enter>.

```
D: > bupdater /o OLD BIOS1.rom
```

Filename      Extension

The [filename] is any user-assigned filename with no more than eight alphanumeric characters for the filename and three alphanumeric characters for the extension.

2. The BIOS Updater backup screen appears indicating the BIOS backup process. When BIOS backup is done, press any key to return to the DOS prompt.

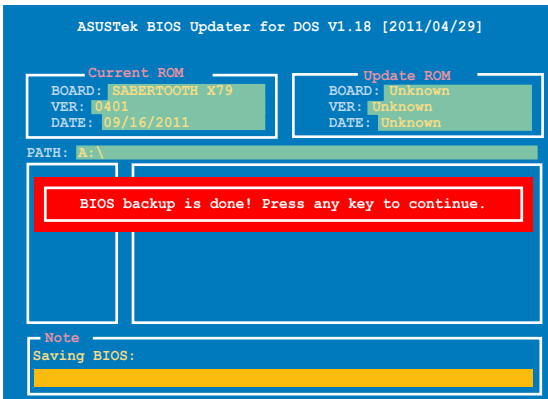

## Updating the BIOS file

To update the BIOS file using BIOS Updater

1. At the FreeDOS prompt, type `bupdater /pc /g` and press <Enter>.

```
D:\>bupdater /pc /g
```

2. The BIOS Updater screen appears as below.

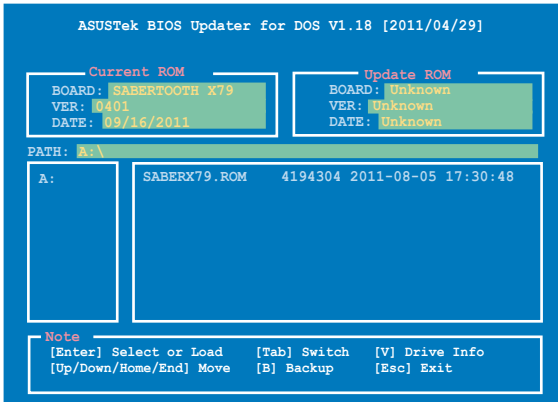

3. Press <Tab> to switch between screen fields and use the <Up/Down/Home/End> keys to select the BIOS file and press <Enter>. BIOS Updater checks the selected BIOS file and prompts you to confirm BIOS update.



4. Select **Yes** and press <Enter>. When BIOS update is done, press <ESC> to exit BIOS Updater. Restart your computer.



DO NOT shut down or reset the system while updating the BIOS to prevent system boot failure!



- For BIOS Updater version 1.04 or later, the utility automatically exits to the DOS prompt after updating BIOS.
- Ensure to load the BIOS default settings to ensure system compatibility and stability. Select the **Load Optimized Defaults** item under the **Exit** BIOS menu. See Chapter 3 of your motherboard user manual for details.
- Ensure to connect all SATA hard disk drives after updating the BIOS file if you have disconnected them.

# Chapter 4

## 4.1 Installing an operating system

This motherboard supports Windows® XP/ 64-bit XP/ Vista / 64-bit Vista / 7 / 64-bit 7 operating systems (OS). Always install the latest OS version and corresponding updates to maximize the features of your hardware.



- Motherboard settings and hardware options vary. Use the setup procedures presented in this chapter for reference only. Refer to your OS documentation for detailed information.
- Ensure that you install the Windows® XP Service Pack 2 or later versions before installing the drivers for better compatibility and system stability.

## 4.2 Support DVD information

The support DVD that comes with the motherboard package contains the drivers, software applications, and utilities that you can install to avail all motherboard features.



The contents of the support DVD are subject to change at any time without notice. Visit the ASUS website at [www.asus.com](http://www.asus.com) for updates.

### 4.2.1 Running the support DVD

Place the support DVD into the optical drive. The DVD automatically displays the Drivers menu if Autorun is enabled in your computer. Click each menu tab and select the items you want to install.

The Drivers menu shows the available device drivers if the system detects installed devices. Install the necessary drivers to use the devices.

The Utilities menu shows the applications and other software that the motherboard supports.

The Make Disk menu contains items to create the RAID/AHCI driver disk.

The Manual menu contains the list of supplementary user manuals. Click an item to open the folder of the user manual.

Click the Contact tab to display the ASUS contact information.

Click an icon to display DVD/ motherboard information

Click an item to install



If Autorun is NOT enabled in your computer, browse the contents of the support DVD to locate the file ASSETUP.EXE from the BIN folder. Double-click the ASSETUP.EXE to run the DVD.

## 4.2.2 Obtaining the software manuals

The software manuals are included in the support DVD. Follow the instructions below to get the necessary software manuals.



The software manual files are in Portable Document Format (PDF). Install the Adobe® Acrobat® Reader from the Utilities menu before opening the files.

1. Click on the **Manual** tab. Click on **ASUS Motherboard Utility Guide** from the manual list on the left.



2. The **Manual** folder of the support DVD appears. Double-click the folder of your selected software.

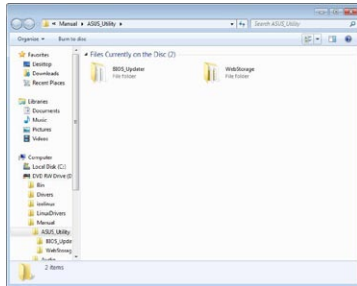

3. Some software manuals are provided in different languages. Double-click the language to show the software manual.

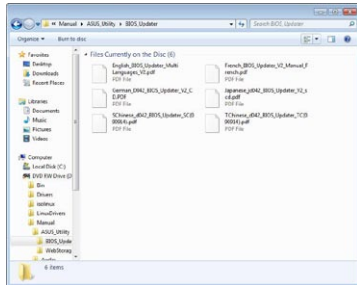

The screenshots in this section are for reference only. The actual software manuals containing in the support DVD vary by models.

## 4.3 Software information

Most of the applications in the support DVD have wizards that will conveniently guide you through the installation. View the online help or readme file that came with the software application for more information.

### 4.3.1 AI Suite II

AI Suite II is an all-in-one interface that integrates several ASUS utilities and allows users to launch and operate these utilities simultaneously.

#### Installing AI Suite II

To install AI Suite II on your computer

1. Place the support DVD to the optical drive. The Drivers installation tab appears if your computer has enabled the Autorun feature.
2. Click the Utilities tab, then click **AI Suite II**.
3. Follow the onscreen instructions to complete installation.

#### Using AI Suite II

AI Suite II automatically starts when you enter the Windows® operating system (OS). The AI Suite II icon appears in the Windows® notification area. Click the icon to open the AI Suite II main menu bar.

Click each button to select and launch a utility, to monitor the system, to update the motherboard BIOS, to display the system information, and to customize the settings of AI Suite II.

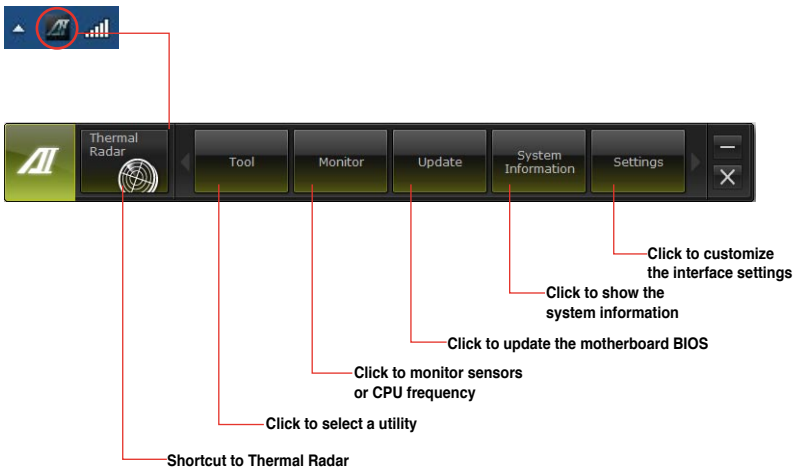

- The applications in the Tool menu vary with models.
- The screenshots of AI Suite II in this user manual are for reference only. The actual screenshots vary with models.
- Refer to the software manual in the support DVD or visit the ASUS website at [www.asus.com](http://www.asus.com) for detailed software configuration.

### 4.3.2 ASUS TUF Thermal Radar

The TUF Thermal Radar monitors temps in critical parts of the motherboard in real time, automatically adjusting fan speeds to make sure the system maintains high stability without overheating. It consists of multiple sensors for various components on the motherboard, giving user the ability to monitor each one individually. The Thermal Radar automatically calculates ideal fan speeds based on different parameters selected by users for each component, keeping everything cooler and longer lasting.

#### Launching Thermal Radar

After installing AI Suite II from the motherboard support DVD, launch Thermal Radar by clicking the **Thermal Radar** icon on the AI Suite II main menu bar.



The software screen captures in this manual are for reference only, but the operation steps remain the same.

#### Using the Thermal Radar main screen





- Click any thermal sensor on the sensor map to read the detail information of the selected sensor.
- On the right part of the Thermal Radar main screen, click **Temperature**, **Fan** or **Voltage** to see the real-time system thermal, fan and voltage information.

## Configuring system fan settings

The TUF Thermal Radar provides easy-to-use fan profiles for adjusting the CPU fan, assistant fan (I/O cover fan), PCH fan, and the chassis fan speeds according to different ambient temperatures caused by different climate conditions in different geographic regions and your PC's system loading. Thermal Radar also provides fully-customizable fan speed control, offering the most flexible controls of fan speed to achieve a quiet and cool environment.

### Loading default fan profiles

To load the system default fan profiles

1. Click  or  from the function list on the bottom of the Thermal Radar main screen.
2. Click a fan to configure. For example, click CPU Fan.



3. Read the introduction and notice of the selected fan. Click **Setting**.



4. Select a fan profile in the **Profile Name** drop-down list and click **Apply**. You can also configure other system fans by clicking the **CHA** and **ASST** icon below.



## Configuring user-customizable fan settings

You can customize the fan speed to meet different computing and environment needs.

To fast customize the fan speed

1. Select **User** in the **Profile Name** drop-down list.
2. Drag the control points on the fan speed curve to set the fan speed percentage.
3. Click **Apply**.



You can also assign the specific system component(s) to monitor and have Thermal Radar to dynamically adjust the fan speeds in real-time when the temperature of the monitored system component reaches to certain degree.

To customize the fan speed with advanced options

1. Select **User** in the **Profile Name** drop-down list.
2. Drag the paper clip icon to the system component(s) listed on the right of the Thermal Radar window. You can assign maximum three components to monitor.



3. Adjust the slider(s) under each component you selected for a combination of 100% and click **Apply**.  
For example, you assign 60% to motherboard, 20% to VCore, and 20% to VCCSA and click **Apply**, Thermal Radar automatically sets the required fan speed by calculating the overall temperature of the monitored components.





4. If you are not sure how to choose the proper components to monitor and the percentage to adjust, click **Auto** and have Thermal Radar do the recommended settings for you. Click **Apply** for the setting to take effect.



### 4.3.3 TurboV EVO

ASUS TurboV EVO introduces **TurboV** that allows you to manually adjust the CPU frequency and related voltage values. After installing AI Suite II from the motherboard support DVD, launch TurboV EVO by clicking **Tool > TurboV EVO** on the AI Suite II main menu bar.



Refer to the software manual in the support DVD or visit the ASUS website at [www.asus.com](http://www.asus.com) for detailed software configuration.

#### TurboV

TurboV allows you to overclock the BCLK frequency, CPU voltage, IMC voltage, and DRAM Bus voltage in Windows® environment and takes effect in real-time without exiting and rebooting the OS.



Refer to the CPU documentation before adjusting CPU voltage settings. Setting a high voltage may damage the CPU permanently, and setting a low voltage may make the system unstable.



For system stability, all changes made in TurboV will not be saved to BIOS settings and will not be kept on the next system boot. Use the **Save Profile** function to save your customized overclocking settings and manually load the profile after Windows starts.

The screenshot shows the TurboV EVO application window. The interface is divided into several sections:

- Profile Section:** Contains a table of current and target values for BCLK Frequency, CPU Vcore Voltage, DRAM CHRB Voltage, and DRAM CHCD Voltage. A 'Save Profile' button is located to the right.
- Advanced Mode Section:** Lists various voltage settings such as CPU VCCSA Voltage, CPU PLL Voltage, VTTCPU Voltage, PCH 1.1 Voltage, PCH 1.5 Voltage, and VTTDDR AB Voltage, each with a slider and a 'V' icon.
- CPU Section:** Displays real-time CPU Frequency (2339.2 MHz) and CPU Usage (97.5 x 24.0).
- Buttons:** 'OS Default Settings', 'Undo', and 'Apply' buttons are at the bottom.

Annotations with red lines point to specific features:

- Load profile Target values:** Points to the 'Save Profile' button.
- Current values:** Points to the 'BCLK Frequency' and 'CPU Vcore Voltage' rows in the Profile table.
- Click to show settings:** Points to the 'V' icon in the 'CPU Vcore Voltage' row.
- Click to restore all start-up settings:** Points to the 'OS Default Settings' button.
- Save the current settings as a new profile:** Points to the 'Save Profile' button.
- Voltage Adjustment bars:** Points to the slider for 'CPU Vcore Voltage'.
- Undoes all changes without applying:** Points to the 'Undo' button.
- Applies all changes immediately:** Points to the 'Apply' button.

## Using Advanced Mode

Click on the **Advanced Mode** tab to adjust the advanced voltage settings.

**Advanced mode Target values**

**Current values**

**Click to restore all start-up settings**

**Voltage Adjustment bars**

**Undoes all changes without applying**

**Applies all changes immediately**

## CPU Ratio

Allows you to manually adjust the CPU ratio.

1. Click the **CPU Ratio** tab.
2. Click **ON** to activate the CPU Ratio function. The system automatically reboots for the changes to take effect.
3. After system reboot, launch TurboV EVO again, and then click the CPU Ratio tab. Drag the adjustment bar upwards or downwards to the desired value.
4. Click **Apply** to make the change take effect.

**CPU Ratio**

**Adjustment bar**

**Click to restore all start-up settings**

**Undoes all changes without applying**

**Applies all changes immediately**



- Set the **CPU Ratio Setting** item in BIOS to [Auto] before using the CPU Ratio function in TurboV. Refer to Chapter 3 of your motherboard user manual for details.
- The CPU Ratio bars show the status of the CPU cores, which vary with your CPU model.

## CPU Strap

Allows you to manually adjust CPU Strap.

1. Click the **CPU Strap** tab.
2. Drag the adjustment bar to the desired value. The graph on the right will change value accordingly.
3. Click **Apply** and reboot the system to make the change take effect.



- Applied settings in CPU Ratio affect CPU Strap results.
- The value on the CPU Strap diagram varies with your CPU model.

### 4.3.4 DIGI+ Power Control

DIGI+ PowerControl allows you to adjust VRM voltage and frequency modulation to enhance reliability and stability. It also provides the highest power efficiency, generating less heat to longer component lifespan and minimize power loss.

After installing AI Suite II from the motherboard support DVD, launch DIGI+ Power Control by clicking **Tool > DIGI+ Power Control** on the AI Suite II main menu bar. Select **CPU Power** or **DRAM Power** to adjust the power control settings.



Function no.	Function description
1	<b>CPU Load-line Calibration</b> It allows you to adjust the voltage settings and control the system temperature. Higher load-line calibration could get higher voltage and good overclocking performance but increases the CPU and VRM thermal.
2	<b>CPU Current Capability</b> CPU Current Capability provides wider total power range for overclocking. A higher value setting gets higher VRM power consumption delivery.
3	<b>CPU Voltage Frequency</b> Switching frequency will affect the VRM transient response and component thermal. Higher frequency gets quicker transient response.
4	<b>VCCSA Load-line Calibration</b> The behavior of the DRAM Controller is decided by the VCCSA Load-line. Set to a higher value for system performance, or to a lower value for better thermal solution.
5	<b>VCCSA Current Capability</b> A higher value brings wider total DRAM Controller power range and extends the overclocking frequency range simultaneously.
6	<b>CPU Power Phase Control</b> Increase phase number under heavy system loading to get more transient and better thermal performance. Reduce phase number under light system loading to increase VRM efficiency.
7	<b>CPU Power Duty Control</b> CPU Power Duty Control adjusts the current of every VRM phase and the thermal of every phase component.

## DRAM Power



Function no.	Function description
1	<b>DRAM Current Capability</b> A higher value brings a wider total power range and extends the overlocking frequency range simultaneously.
2	<b>DRAM Voltage Frequency</b> Allows you to adjust the DRAM switching frequency for system stability or to increase OC Range.
3	<b>DRAM Power Phase Control</b> Set Manual Adjustment to faster phase response to increase system performance or to slower phase response to increase DRAM power efficiency.



- The actual performance boost may vary depending on your CPU and DRAM specification.
- Do not remove the thermal module. The thermal conditions should be monitored.

### 4.3.5 Sensor Recorder

Sensor Recorder monitors the changes in the system voltage, temperature, and fan speed on a timeline. The History Record function allows you to designate specific time spans on record to keep track of the three system statuses for certain purposes.

#### Launching Sensor Recorder

After installing AI Suite II from the motherboard support DVD, launch Sensor Recorder by clicking **Tool > Sensor Recorder** on the AI Suite II main menu bar.

#### Using Sensor Recorder

Click on **Voltage/ Temperature/ Fan Speed** tabs for the status you want to monitor. Colored lines will automatically appear on the diagram to indicate the immediate changes in the system status.

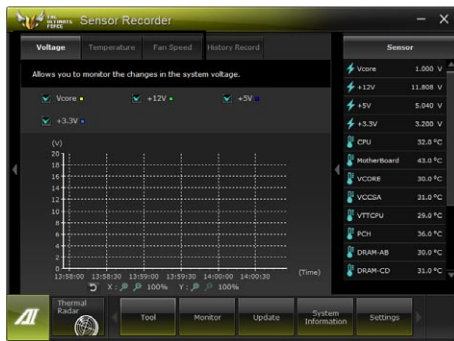

#### Using History Record

1. Click on the **History Record** tab and adjust the settings on the left for **Type**, **Date**, **Record Interval**, and **Record Duration** according to need.
2. Colored lines will then appear on the diagram to indicate the changes in the requested status of the given time.
3. Click on **Recording** to record the history changes.



Click on **Monitor > Sensor** on the AI Suite II main menu bar and a highlight of the system statuses will appear on the right panel.

### 4.3.6 USB 3.0 Boost

The ASUS exclusive USB 3.0 Boost provides speed boost for USB 3.0 devices and the up-to-date support of USB Attached SCSI Protocol (UASP). With USB 3.0 Boost, you can accelerate the transfer speed of your USB 3.0 devices with ease.

#### Launching USB 3.0 Boost

After installing AI Suite II from the motherboard support DVD, launch USB 3.0 Boost by clicking **Tool > USB 3.0 Boost** on the AI Suite II main menu bar.

#### Configuring USB 3.0 Boost

1. Connect a USB 3.0 device to the USB 3.0 port.
2. USB 3.0 Boost automatically detects the property of the connected device and switches to **Turbo** mode or **UASP** mode (if UASP is supported by the connected device).
3. You can manually switch the USB 3.0 mode back to **Normal** mode at any time.

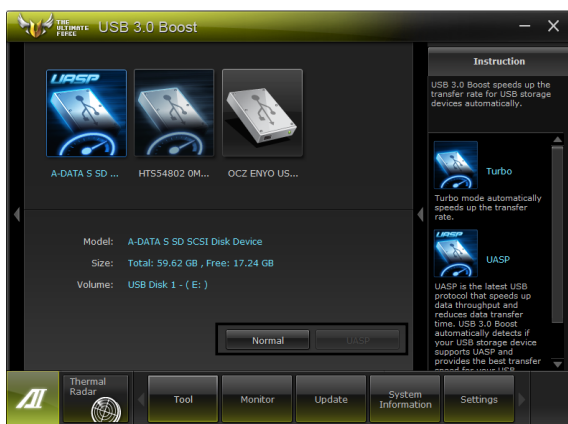

Refer to the software manual in the support DVD or visit the ASUS website at [www.asus.com](http://www.asus.com) for detailed software configuration.



### 4.3.7 ASUS SSD Caching

This feature boosts system performance by using an installed SSD with no capacity limitations as a cache for frequently accessed data. Harness a combination of SSD-like performance and response and hard drive capacity with just one click. No rebooting is needed with instant activation for complete ease of use.

#### Launching ASUS SSD Caching

After installing AI Suite II from the motherboard support DVD, launch ASUS SSD Caching by clicking **Tool > ASUS SSD Caching** on the AI Suite II main menu bar.

#### Configuring ASUS SSD Caching

1. Connect one HDD and one SSD to the the Marvell® SATA ports (SATA6G\_E1/E2). ASUS SSD Caching automatically detects the HDD and SSD.
2. Click on **Caching Now!** to initialize the connected disks. Initialization status is shown on the program interface.
3. Caching function will be activated once initialization is complete.
4. Click on **Disable** when deactivating SSD caching.



- During initialization, you can proceed with doing any system operations. You can check the caching status later or wait for a pop-up message notifying that initialization is completed.
- For regular usage, the SATA6G\_E1/E2 connectors are recommended for data drives.
- After disabling SSD Caching, the SSD will become a non-configurable disk in Windows OS. To use the SSD again for normal functions, go to Disk Management to reconfigure the SSD.

### 4.3.8 ASUS Update

ASUS Update lays out the options for updating BIOS on your system. Update BIOS utility on your system or simply save the utility for later use just by following the directions on this convenient updating feature.

#### Launching ASUS Update

After installing AI Suite II from the motherboard support DVD, launch ASUS Update by clicking **Update> ASUS Update** on the AI Suite II main menu bar.

#### Using ASUS Update

Select the way you would like to do with the BIOS utility. Click on **Next** and follow the instructions to complete your request.

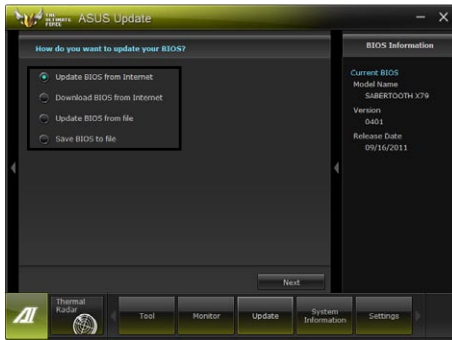

- **Update BIOS from Internet**  
Download the latest BIOS utility from the ASUS service website ([www.asus.com](http://www.asus.com)) and follow the suggested procedures to update the BIOS version on your system.
- **Download BIOS from Internet**  
Download the latest BIOS utility from the ASUS service website ([www.asus.com](http://www.asus.com)) and save for later use.
- **Update BIOS from file**  
Use the BIOS utility demanded from a source file to update the BIOS version on your system.
- **Save BIOS to file**  
Back up the current BIOS utility on your system to another file or USB disk to save for later use.



---

There may be risks of system crash when updating BIOS. Backing up the original BIOS utility is recommended before updating.

---

### 4.3.9 MyLogo2

This MyLogo utility lets you customize the boot logo. The boot logo is the image that appears on screen during the Power-On-Self-Tests (POST). Personalize your computer from the very beginning!

#### Launching ASUS Update

After installing AI Suite II from the motherboard support DVD, launch MyLogo by clicking **Update> MyLogo** on the AI Suite II main menu bar.

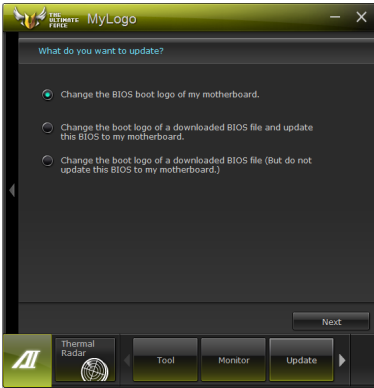

#### Using MyLogo

Select the way you would like to do update your boot logo. Then click Next and follow the given instructions.

#### Change the BIOS boot logo of my motherboard

1. Under Current BIOS, click **Browse** and choose the desired image for your boot logo. Then click on Next.

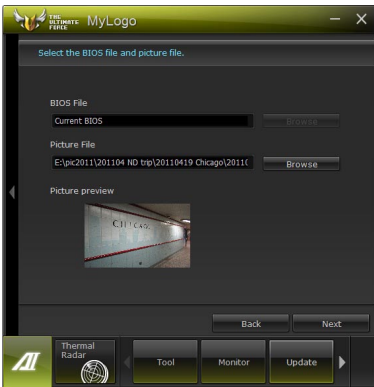

2. Click on **Auto Tune** to adjust image size compatibility or adjust the resolution bar.
3. You can click on Booting Preview to preview the boot image. Then click Next.
4. Click on Flash to start updating the image to the boot logo.
5. Click on Yes to reboot or you can also see the new logo next time you restart your computer.

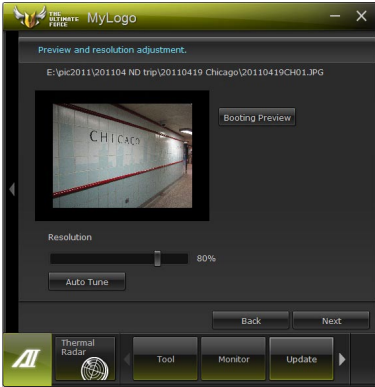

### Change the boot logo of a downloaded BIOS file and update (or do not update) this BIOS to the motherboard

1. At BIOS File, **Browse** to download the requested BIOS file to your system. This utility will help you detect the compatibility of the BIOS version.
2. Then at Picture File, Browse to select the desired image for boot logo. Click Next.
3. Follow steps 2-5 in **Change the BIOS boot logo of my motherboard** to complete logo update.

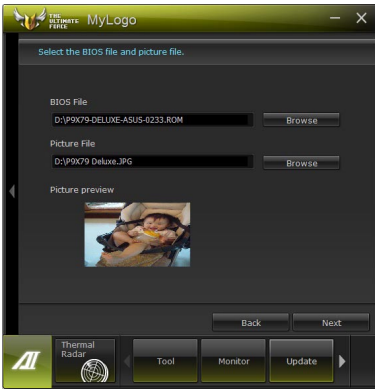

The fullscreen logo application in BIOS utility must be enabled for MyLogo to take effect.

### 4.3.10 Audio configurations

The Realtek® audio CODEC provides 8-channel audio capability to deliver the ultimate audio experience on your computer. The software provides Jack-Detection function, S/PDIF Out support, and interrupt capability. The CODEC also includes the Realtek® proprietary UAJ® (Universal Audio Jack) technology for all audio ports, eliminating cable connection errors and giving users plug and play convenience.

Follow the installation wizard to install the Realtek® Audio Driver from the support DVD that came with the motherboard package.

If the Realtek audio software is correctly installed, you will find the **Realtek HD Audio Manager** icon on the taskbar. Double-click on the icon to display the Realtek HD Audio Manager.



Realtek HD Audio Manager

#### A. Realtek HD Audio Manager for Windows® Vista™



#### B. Realtek HD Audio Manager for Windows XP



Refer to the software manual in the support DVD or visit the ASUS website at [www.asus.com](http://www.asus.com) for detailed software configuration.

## 4.4 RAID configurations

The motherboard comes with the Intel® X79 chipset and Marvell SATA controller that allow you to configure Serial ATA hard disk drives as RAID sets. The motherboard supports the following RAID configurations:

- **Intel® Rapid Storage Technology** with RAID 0, RAID 1, RAID 10 and RAID 5 support.
- **Marvell® RAID utility** with RAID 0 and RAID 1 support.



- You must install Windows® XP Service Pack 3 or later versions before using Serial ATA hard disk drives. The Serial ATA RAID feature is available only if you are using Windows® XP Service Pack 3 or later versions.
- Due to Windows® XP / Vista limitation, a RAID array with the total capacity over 2TB cannot be set as a boot disk. A RAID array over 2TB can only be set as a data disk only.
- If you want to install a Windows® operating system to a hard disk drive included in a RAID set, you have to create a RAID driver disk and load the RAID driver during OS installation. Refer to section 4.5 **Creating a RAID driver disk** for details.

### 4.4.1 RAID definitions

**RAID 0 (Data striping)** optimizes two identical hard disk drives to read and write data in parallel, interleaved stacks. Two hard disks perform the same work as a single drive but at a sustained data transfer rate, double that of a single disk alone, thus improving data access and storage. Use of two new identical hard disk drives is required for this setup.

**RAID 1 (Data mirroring)** copies and maintains an identical image of data from one drive to a second drive. If one drive fails, the disk array management software directs all applications to the surviving drive as it contains a complete copy of the data in the other drive. This RAID configuration provides data protection and increases fault tolerance to the entire system. Use two new drives or use an existing drive and a new drive for this setup. The new drive must be of the same size or larger than the existing drive.

**RAID 5** stripes both data and parity information across three or more hard disk drives. Among the advantages of RAID 5 configuration include better HDD performance, fault tolerance, and higher storage capacity. The RAID 5 configuration is best suited for transaction processing, relational database applications, enterprise resource planning, and other business systems. Use a minimum of three identical hard disk drives for this setup.

**RAID 10** is data striping and data mirroring combined without parity (redundancy data) having to be calculated and written. With the RAID 10 configuration you get all the benefits of both RAID 0 and RAID 1 configurations. Use four new hard disk drives or use an existing drive and three new drives for this setup.

## 4.4.2 Installing Serial ATA hard disks

The motherboard supports Serial ATA hard disk drives. For optimal performance, install identical drives of the same model and capacity when creating a disk array.

To install the SATA hard disks for a RAID configuration:

1. Install the SATA hard disks into the drive bays.
2. Connect the SATA signal cables.
3. Connect a SATA power cable to the power connector on each drive.

## 4.4.3 Setting the RAID item in BIOS

You must enable the RAID function in the BIOS Setup before creating RAID set(s) using SATA HDDs. To do this:

1. Enter the BIOS Setup during POST.
2. Go to the **Advanced** menu > **SATA Configuration**, and then press <Enter>.
3. Set the **SATA Mode** item to [RAID Mode].
4. Save your changes, and then exit the BIOS Setup.



Refer to Chapter 3 for details on entering and navigating through the BIOS Setup.



Due to chipset limitation, when set any of SATA ports to RAID mode, all SATA ports run at RAID mode together.

## 4.4.4 Intel® Rapid Storage Technology Option ROM utility

To enter the Intel® Rapid Storage Technology Option ROM utility:

1. Turn on the system.
2. During POST, press <Ctrl> + <I> to display the utility main menu.

```
Intel(R) Rapid Storage Technology - Option ROM - v10.0.0.1032
Copyright(C) 2003-10 Intel Corporation. All Rights Reserved.

[ MAIN MENU ]
1. Create RAID Volume
2. Delete RAID Volume
3. Reset Disks to Non-RAID
4. Recovery Volume Options
5. Exit

[ DISK/VOLUME INFORMATION ]

RAID Volumes:
None defined.

Physical Devices:
Port Device Model Serial # Size Type/Status (Vol ID)
0 ST3160812AS 9LS0HJA4 149.0GB Non-RAID Disk
1 ST3160812AS 9LS0F4HL 149.0GB Non-RAID Disk
2 ST3160812AS 3LS0JYL8 149.0GB Non-RAID Disk
3 ST3160812AS 9LS0B75H 149.0GB Non-RAID Disk

[↑↓]-Select [ESC]-Exit [ENTER]-Select Menu
```

The navigation keys at the bottom of the screen allow you to move through the menus and select the menu options.



The RAID BIOS setup screens shown in this section are for reference only and may not exactly match the items on your screen.



The utility supports maximum four hard disk drives for RAID configuration.

## Creating a RAID set

To create a RAID set:

1. From the utility main menu, select **1. Create RAID Volume** and press <Enter>. The following screen appears:

```
Intel(R) Rapid Storage Technology - Option ROM - v10.0.0.1032
Copyright(C) 2003-10 Intel Corporation. All Rights Reserved.

-----[ CREATE VOLUME MENU ]-----
Name: Volume0
RAID Level: RAID0(Stripe)
Disks: Select Disks
Strip Size: 128KB
Capacity: 0.0 GB
Sync: N/A
Create Volume

-----[ HELP ]-----

Enter a unique volume name that has no special characters and is
16 characters or less.

[↑↓]-Change [TAB]-Next [ESC]-Previous Menu [ENTER]-Select
```

2. Enter a name for the RAID set and press <Enter>.
3. When the **RAID Level** item is selected, press the up/down arrow key to select a RAID level to create, and then press <Enter>.
4. When the **Disks** item is selected, press <Enter> to select the hard disk drives you want to include in the RAID set. The **SELECT DISKS** screen appears:

```
-----[ SELECT DISKS ]-----
Port Drive Model Serial # Size Status
0 SW16031P2AS 9LS0BJ4Y 149.0GB Non-RAID Disk
1 ST3160812AS 9LS0F4HL 149.0GB Non-RAID Disk
2 ST3160812AS 3LS0JYL8 149.0GB Non-RAID Disk
3 ST3160812AS 9LS0BJ5H 149.0GB Non-RAID Disk

Select 2 to 6 disks to use in creating the volume.

[↑↓]-Prev/Next [SPACE]-SelectDisk [ENTER]-Done
```



5. Use the up/down arrow key to select a drive, and then press <Space> to select. A small triangle marks the selected drive. Press <Enter> after completing your selection.
6. Use the up/down arrow key to select the stripe size for the RAID array (for RAID 0, 10 and 5 only), and then press <Enter>. The available stripe size values range from 4KB to 128KB. The following are typical values:  
RAID 0: 128KB  
RAID 10: 64KB  
RAID 5: 64KB



---

We recommend a lower stripe size for server systems, and a higher stripe size for multimedia computer systems used mainly for audio and video editing.

---

7. When the **Capacity** item is selected, enter the RAID volume capacity that you want and press <Enter>. The default value indicates the maximum allowed capacity.
8. When the **Create Volume** item is selected, press <Enter>. The following warning message appears:



9. Press <Y> to create the RAID volume and return to the main menu, or <N> to go back to the **CREATE VOLUME** menu.

## Deleting a RAID set



Take caution when deleting a RAID set. You will lose all data on the hard disk drives when you delete a RAID set.

To delete a RAID set:

1. From the utility main menu, select **2. Delete RAID Volume** and press <Enter>. The following screen appears:

```
Intel(R) Rapid Storage Technology - Option ROM - v10.0.0.1032
Copyright(C) 2003-10 Intel Corporation. All Rights Reserved.

[ DELETE VOLUME MENU ]

Name      Level      Drives  Capacity  Status  Bootable
Volume0   RAID0(Stripe)  2       298.0GB  Normal  Yes

[ HELP ]

Deleting a volume will reset the disks to non-RAID.
WARNING: ALL DISK DATA WILL BE DELETED.
(This does not apply to Recovery volumes)

[↑↓]-Select      [ESC]-Previous Menu  [DEL]-Delete Volume
```

2. Use the up/down arrow key to select the RAID set you want to delete, and then press <Del>. The following warning message appears:

```
[ DELETE VOLUME VERIFICATION ]

ALL DATA IN THE VOLUME WILL BE LOST!
(This does not apply to Recovery volumes)

Are you sure you want to delete volume "Volume0"? (Y/N) :
```

3. Press <Y> to delete the RAID set and return to the utility main menu, or press <N> to return to the **DELETE VOLUME** menu.

## Exiting the Intel® Rapid Storage Technology Option ROM utility

To exit the utility:

1. From the utility main menu, select **5. Exit**, and then press <Enter>. The following warning message appears:

```
[ CONFIRM EXIT ]

Are you sure you want to exit? (Y/N) :
```

2. Press <Y> to exit or press <N> to return to the utility main menu.

## 4.4.5 Marvell RAID utility

The onboard Marvell SATA 6.0 Gb/s controller allows you to create a RAID 0 or RAID 1 array using two SATA hard disk drives. Refer to Chapter 2 of your motherboard user manual for the exact location of the Marvell SATA 6.0 Gb/s connector.

To enter the Marvell utility, press **<Ctrl> + <M>** during POST.



All existing data on the hard disk drives will be erased when creating or deleting a RAID array. Ensure that you have back up all your data in your hard disk drives before making any change to the drive status.

```
Marvell BIOS Setup (c) 2009 Marvell Technology Group Ltd.
-----
Topology                                Information
-----
HBA 0: Marvell 0                          Vendor ID       : 1B4B
  Virtual Disks                             Device ID      : 9130
  Free Physical Disks                       Revision ID    : B1
    PD 0: ST3160812AS                       BIOS Version   : 1.0.0.1028
    PD 8: ST3160812AS                       Firmware Version: 2.2.0.1105
                                           PCIe Speed Rate : 5.0Gbps
                                           Configure SATA as: AHCI Mode

Help
-----
Marvell RAID on chip controller.
ENTER: Operation  F10: Exit/Save  ESC: Return
```

### Create a RAID Array

1. Move the selection bar to **HBA 0: Marvell 0** and press **<Enter>**.
2. Select **Configuration Wizard** and press **<Enter>**.

```
Marvell BIOS Setup (c) 2009 Marvell Technology Group Ltd.
-----
Configure->Select free disks
-----
HBA 0: Marvell 0                          Port ID       : 0
  Virtual Disks                             PD ID        : 0
  Free Physical Disks                       Type         : SATA PD
    * PD 0: ST3160812AS                     Status      : Unconfigured
    PD 8: ST3160812AS                       Size        : 152626MB
                                           Feature Support: MCQ 3G 48Bits
                                           Current Speed : 3G
                                           Model       : ST3160812AS
                                           Serial      : 9LS0F4HL
                                           FW Version  : 3.AAE

Help
-----
Use space bar to select the free disks to be used in the array.
ENTER: Operation  SPACE: Select  F10: Exit/Save  ESC: Return
```

3. Press **<Space>** to select the hard drives to be included in the RAID array. An asterisk (\*) appears in front of the selected hard drive. After selecting all the drives needed for the RAID array, press **<Enter>** to continue.

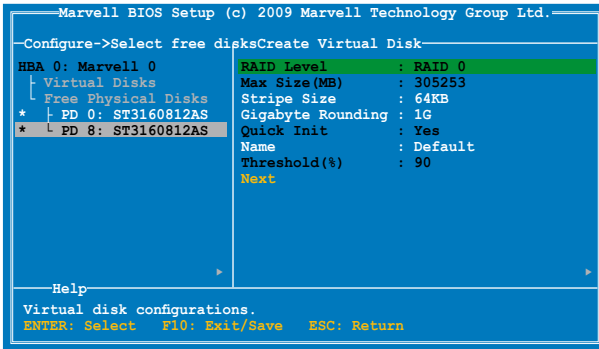

- Use the up or down arrow key to move the selection bar and press <Enter> to configure further RAID settings.

**RAID Level:** Select a RAID Level. Configuration options: [RAID 0] [RAID 1]

**Stripe Size:** Specifies the size of single data block on the virtual disk. In general, a larger stripe size is recommended for applications requiring large data transfers such as audio, video, and graphics. A smaller stripe size is better for applications with content in much smaller size, such as e-mails and documents.

Configuration options: [32K] [64K]

**Gigabyte Rounding:** In the event of a single physical disk failure in a RAID 1 virtual disk, Gigabyte Rounding allows the replacement physical disk to be of a size slightly smaller than the existing physical disk. The capacity of the rebuilt virtual disk equals to the size of the smaller physical disk included in the RAID 1 array. The configuration options represent the tolerance value of drive capacity difference.

Configuration options: [None] [1G] [10G]

**Name:** Enter a name with 1–10 letters (no special characters) for the RAID array.

- Move the selection bar to **Next** and press <Enter>. The following warning message appears:

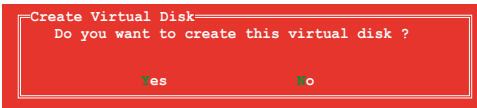

Press <Y> to create the RAID array, or press <N> to cancel. The new RAID array appears under Virtual Disks, as shown in the image below.

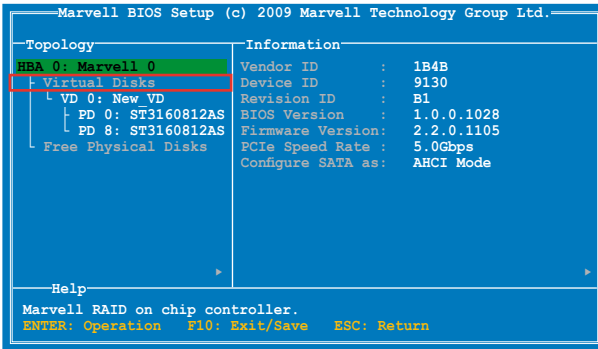

- Press <F10>. The following warning message appears:



Press <Y> to save the RAID setting and exit the Marvell RAID utility.

## Delete an existing RAID Array

- Select the RAID array to delete and press <Enter>. Select **Delete** and press <Enter>.

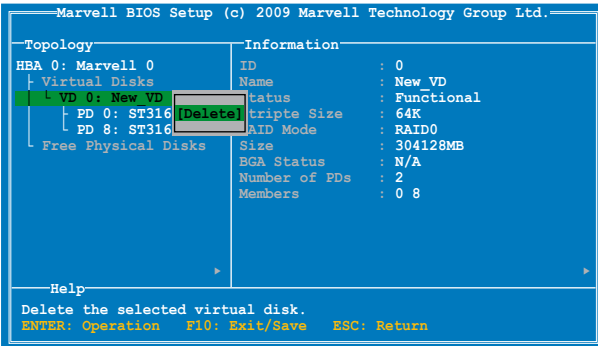

2. The following warning message appears:

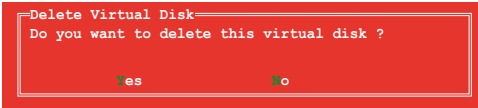

Press <Y> to delete the selected RAID array. The following warning message appears:



Press <Y> to delete the Master Boot Record (MBR) from the selected RAID array.

3. Press <F10>. The following warning message appears:



Press <Y> to save the RAID setting and exit the Marvell RAID utility.

## 4.5 Creating a RAID driver disk

A floppy disk with the RAID driver is required when installing a Windows® operating system on a hard disk drive that is included in a RAID set.



- **The motherboard does not provide a floppy drive connector.** You have to use a USB floppy disk drive when creating a **SATA** RAID driver disk.
- Windows® XP may not recognize the USB floppy disk drive due to Windows® XP limitation. To work around this OS limitation, refer to section **4.5.4 Using a USB floppy disk drive**.

### 4.5.1 Creating a RAID driver disk without entering the OS

To create a RAID driver disk without entering the OS:

1. Boot your computer.
2. Press <Del> during POST to enter the BIOS setup utility.
3. Set the optical drive as the primary boot device.
4. Insert the support DVD into the optical drive.
5. Save changes and exit BIOS.
6. When the **Make Disk** menu appears, press <1> to create a RAID driver disk.
7. Insert a formatted floppy disk into the USB floppy disk drive, then press <Enter>.
8. Follow the succeeding screen instructions to complete the process.

### 4.5.2 Creating a RAID driver disk in Windows®

To create a RAID driver disk in Windows®:

1. Start Windows®.
2. Plug the USB floppy disk drive and insert a floppy disk.
3. Place the motherboard support DVD into the optical drive.
4. Go to the **Make Disk** menu, and then click **Intel AHCI/RAID Driver Disk** to create a RAID driver disk.
5. Select USB floppy disk drive as the destination disk.
6. Follow the succeeding screen instructions to complete the process.



Write-protect the floppy disk to avoid a computer virus infection.

### 4.5.3 Installing the RAID driver during Windows® OS installation

To install the RAID driver in Windows® XP:

1. During the OS installation, the system prompts you to press the F6 key to install third-party SCSI or RAID driver.
2. Press <F6>, and then insert the floppy disk with RAID driver into the USB floppy disk drive.
3. When prompted to select the SCSI adapter to install, select the RAID driver for the corresponding OS version.
4. Follow the succeeding screen instructions to complete the installation.

To install the RAID driver for Windows® Vista or later OS:

1. During the OS installation, click **Load Driver** to allow you to select the installation media containing the RAID driver.
2. Insert the USB flash drive with RAID driver into the USB port or the support DVD into the optical drive, and then click **Browse**.
3. Click the name of the device you've inserted, go to **Drivers > RAID**, and then select the RAID driver for the corresponding OS version. Click **OK**.
4. Follow the succeeding screen instructions to complete the installation.



---

Before loading the RAID driver from a USB flash drive, you have to use another computer to copy the RAID driver from the support DVD to the USB flash drive.

---



## 4.5.4 Using a USB floppy disk drive

Due to OS limitation, Windows® XP may not recognize the USB floppy disk drive when you install the RAID driver from a floppy disk during the OS installation.

To solve this issue, add the USB floppy disk drive's Vendor ID (VID) and Product ID (PID) to the floppy disk containing the RAID driver. Refer to the steps below:

1. Using another computer, plug the USB floppy disk drive, and insert the floppy disk containing the RAID driver.
2. Right-click **My Computer** on the Windows® desktop or **start** menu, and then select **Manage** from the pop-up window.

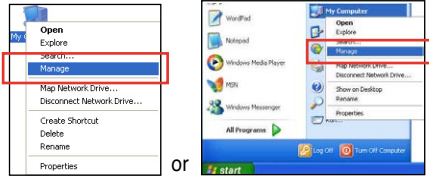

3. Select **Device Manager**. From the **Universal Serial Bus controllers**, right-click **xxxxxx USB Floppy**, and then select **Properties** from the pop-up window.



The name of the USB floppy disk drive varies with different vendors.

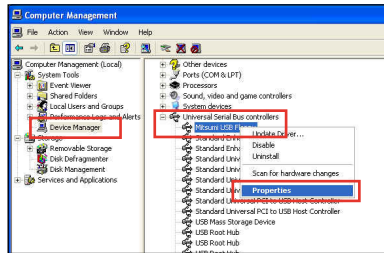

4. Click **Details** tab. The Vendor ID (VID) and Product ID (PID) are displayed.

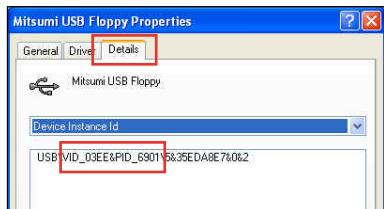

5. Browse the contents of the RAID driver disk to locate the file **txtsetup.oem**.
6. Double-click the file. A window appears, allowing you to select the program for opening the oem file.

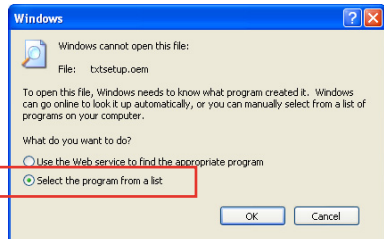

7. Use Notepad to open the file.

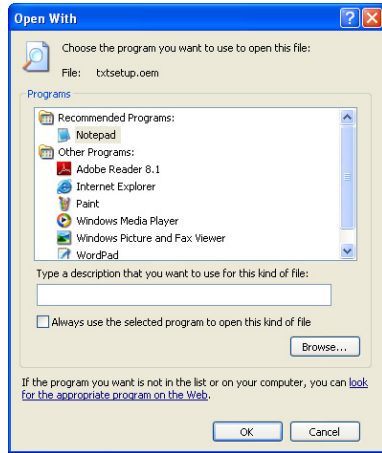

8. Find the `[HardwareIds.scsi.iaAHCI_DesktopWorkstationServer]` and `[HardwareIds.scsi.iaStor_DesktopWorkstationServer]` sections in the `txtsetup.oem` file.
9. Type the following line to the bottom of the two sections:
- `id = "USB\VID_03EE&PID_6901", "usbstor"`

```
[HardwareIds.scsi.iaAHCI_DesktopWorkstationServer]
id= "PCI\VEN_8086&DEV_1C02&CC_0106", "iaStor"
id= "USB\VID_03EE&PID_6901", "usbstor"

[HardwareIds.scsi.iaStor_DesktopWorkstationServer]
id= "PCI\VEN_8086&DEV_2822&CC_0104", "iaStor"
id= "USB\VID_03EE&PID_6901", "usbstor"
```



\_\_\_\_\_

Add the same line to both sections.

\_\_\_\_\_



\_\_\_\_\_

The VID and PID vary with different vendors.

\_\_\_\_\_

10. Save and exit the file.

# Chapter 5

## 5.1 AMD® CrossFireX™ technology

The motherboard supports the AMD® CrossFireX™ technology that allows you to install multi-graphics processing units (GPU) graphics cards. Follow the installation procedures in this section.

### 5.1.1 Requirements

- In Dual CrossFireX mode, you should have two identical CrossFireX-ready graphics cards or one CrossFireX-ready dual-GPU graphics card that are AMD® certified.
- Ensure that your graphics card driver supports the AMD CrossFireX technology. Download the latest driver from the AMD website ([www.amd.com](http://www.amd.com)).
- Ensure that your power supply unit (PSU) can provide at least the minimum power required by your system. See Chapter 2 for details.



- 
- We recommend that you install additional chassis fans for better thermal environment.
  - Visit the AMD Game website (<http://game.amd.com>) for the latest certified graphics card and the supported 3D application list.
- 

### 5.1.2 Before you begin

For AMD CrossFireX to work properly, you have to uninstall all existing graphics card drivers before installing AMD CrossFireX graphics cards to your system.

To uninstall existing graphics card drivers:

1. Close all current applications.
2. For Windows XP, go to **Control Panel > Add/Remove Programs**.  
For Windows Vista, go to **Control Panel > Programs and Features**.
3. Select your current graphics card driver/s.
4. For Windows XP, select **Add/Remove**.  
For Windows Vista, select **Uninstall**.
5. Turn off your computer.

### 5.1.3

## Installing two CrossFireX™ AMD CrossFireX TECHNOLOGY graphics cards



The following pictures are for reference only. The graphics cards and the motherboard layout may vary with models, but the installation steps remain the same.

1. Prepare two CrossFireX-ready graphics cards.
2. Insert the two graphics card into the PCIEX16 slots. If your motherboard has more than two PCIEX16 slots, refer to Chapter 2 in this user manual for the locations of the PCIEX16 slots recommended for multi-graphics card installation.
3. Ensure that the cards are properly seated on the slots.
4. Align and firmly insert the CrossFireX bridge connector to the goldfingers on each graphics card. Ensure that the connector is firmly in place.

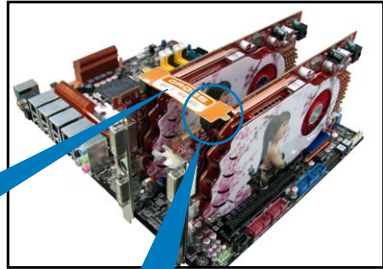
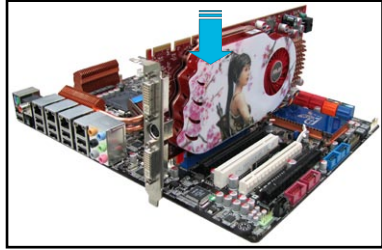

CrossFireX bridge  
(bundled with  
graphics cards)

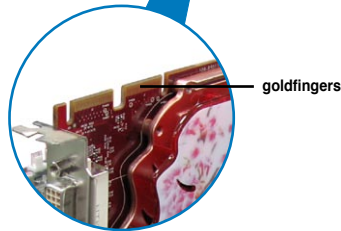

5. Connect two independent auxiliary power sources from the power supply to the two graphics cards separately.
6. Connect a VGA or a DVI cable to the graphics card.

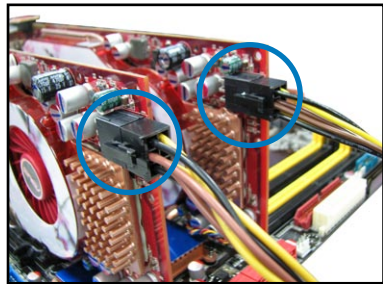

### 5.1.4 Installing the device drivers

Refer to the documentation that came with your graphics card package to install the device drivers.



Ensure that your PCI Express graphics card driver supports the AMD® CrossFireX™ technology. Download the latest driver from the AMD website (www.amd.com).

### 5.1.5 Enabling the AMD® CrossFireX™ technology

After installing your graphics cards and the device drivers, enable the CrossFireX™ feature through the AMD Catalyst™ Control Center in Windows environment.

#### Launching the AMD VISION Engine Control Center

To launch the AMD VISION Engine Control Center:

1. Right-click on the Windows® desktop and select **AMD VISION Engine Control Center**. You can also right-click the AMD icon in the Windows notification area and select **Vision Engine Control Center**.

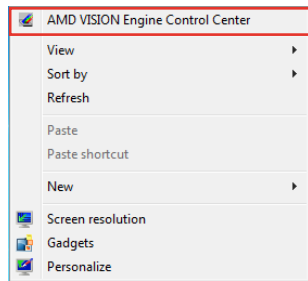

2. The **VISION Engine Control Center Setup Assistant** appears when the system detects the existence of multi-graphics cards. Click **Go** to continue to the **VISION Engine Control Center Advanced View** window.

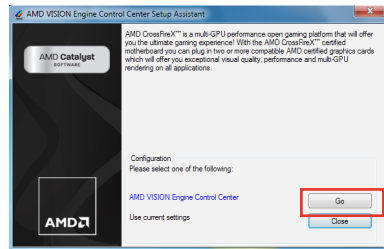

#### Enabling Dual CrossFireX technology

1. In the Catalyst Control Center window, click **Graphics Settings > Performance > AMD CrossFireX™ Configuration**.
2. From the Graphics Adapter list, select the graphics card to act as the display GPU.
3. Select **Enable CrossFireX™**.
4. Click **Apply**, and then click **OK** to exit the window.

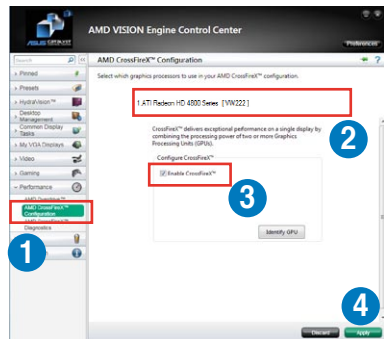

## 5.2 NVIDIA® SLI™ technology

The motherboard supports the NVIDIA® SLI™ (Scalable Link Interface) technology that allows you to install multi-graphics processing units (GPU) graphics cards. Follow the installation procedures in this section.

### 5.2.1 Requirements

- In SLI mode, you should have two identical SLI-ready graphics cards that are NVIDIA® certified.
- Ensure that your graphics card driver supports the NVIDIA SLI technology. Download the latest driver from the NVIDIA website ([www.nvidia.com](http://www.nvidia.com)).
- Ensure that your power supply unit (PSU) can provide at least the minimum power required by your system. See Chapter 2 for details.



- We recommend that you install additional chassis fans for better thermal environment.
- Visit the NVIDIA zone website (<http://www.nzone.com>) for the latest certified graphics card and supported 3D application list.

### 5.2.2 Installing two SLI-ready graphics cards



The following pictures are for reference only. The graphics cards and the motherboard layout may vary with models, but the installation steps remain the same.

1. Prepare two SLI-ready graphics cards.
2. Insert the two graphics card into the PCIEX16 slots. If your motherboard has more than two PCIEX16 slots, refer to Chapter 2 in this user manual for the locations of the PCIEX16 slots recommended for multi-graphics card installation.
3. Ensure that the cards are properly seated on the slots.

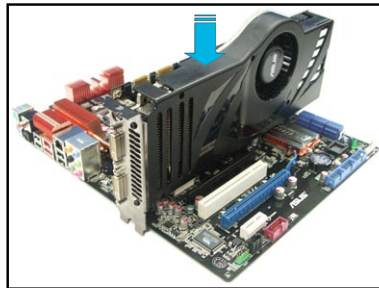

4. Align and firmly insert the SLI bridge connector to the goldfingers on each graphics card. Ensure that the connector is firmly in place.
5. Connect two independent auxiliary power sources from the power supply to the two graphics cards separately.
6. Connect a VGA or a DVI cable to the graphics card.

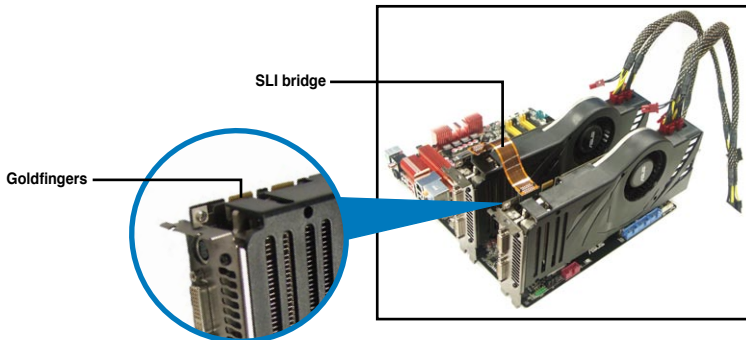

### 5.2.3 Installing the device drivers

Refer to the documentation that came with your graphics card package to install the device drivers.



Ensure that your PCI Express graphics card driver supports the NVIDIA® SLI™ technology. Download the latest driver from the NVIDIA website ([www.nvidia.com](http://www.nvidia.com)).

### 5.2.4 Enabling the NVIDIA® SLI™ technology

After installing your graphics cards and the device drivers, enable the SLI feature in NVIDIA® Control Panel under the Windows® Vista™ operating system.

#### Launching the NVIDIA Control Panel

You can launch the NVIDIA Control Panel by the following two methods.

- A. Right click on the empty space of the Windows® desktop and select **NVIDIA Control Panel**.

The NVIDIA Control Panel window appears (See Step B5).

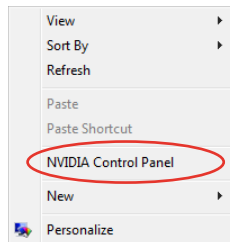

- B1. If you cannot see the NVIDIA Control Panel item in step (A), select **Personalize**.

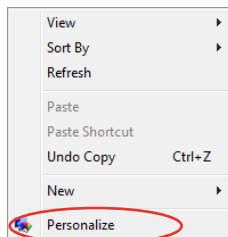

- B2. From the **Personalization** window, select **Display Settings**.

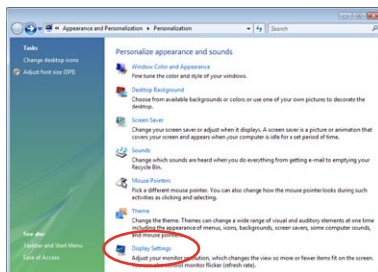

- B3. From the Display Settings dialog box, click **Advanced Settings**.

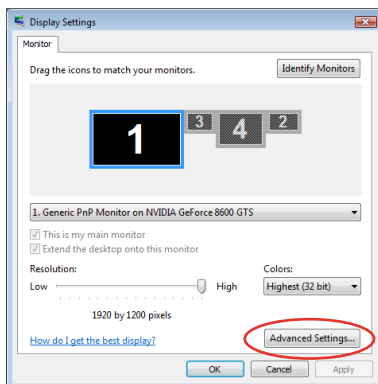



- B4. Select the NVIDIA GeForce tab, and then click **Start the NVIDIA Control Panel**.

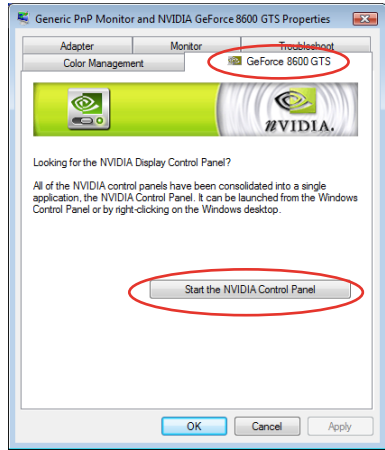

- B5. The NVIDIA Control Panel window appears.

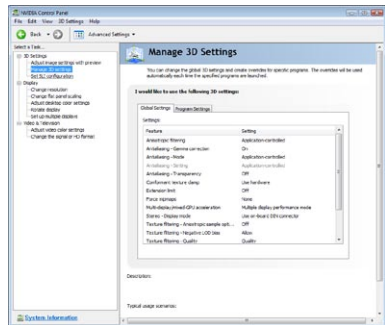

### Enabling SLI settings

From the NVIDIA Control Panel window, select **Set SLI Configuration**. Click **Enable SLI** and set the display for viewing SLI rendered content. When done, click **Apply**.

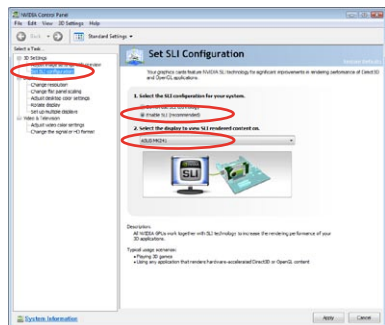



## **ASUS contact information**

### **ASUSTeK COMPUTER INC.**

Address	15 Li-Te Road, Peitou, Taipei, Taiwan 11259
Telephone	+886-2-2894-3447
Fax	+886-2-2890-7798
E-mail	info@asus.com.tw
Web site	www.asus.com.tw

#### ***Technical Support***

Telephone	+86-21-38429911
Online support	support.asus.com

### **ASUS COMPUTER INTERNATIONAL (America)**

Address	800 Corporate Way, Fremont, CA 94539, USA
Telephone	+1-812-282-3777
Fax	+1-510-608-4555
Web site	usa.asus.com

#### ***Technical Support***

Telephone	+1-812-282-2787
Support fax	+1-812-284-0883
Online support	support.asus.com

### **ASUS COMPUTER GmbH (Germany and Austria)**

Address	Harkort Str. 21-23, D-40880 Ratingen, Germany
Fax	+49-2102-959911
Web site	www.asus.de
Online contact	www.asus.de/sales

#### ***Technical Support***

Telephone	+49-1805-010923*
Support Fax	+49-2102-9599-11
Online support	support.asus.com

\* EUR 0.14/minute from a German fixed landline; EUR 0.42/minute from a mobile phone.

# DECLARATION OF CONFORMITY

Per FCC Part 2, Section 2.1077(a)



Responsible Party Name: **Asus Computer International**

Address: **800 Corporate Way, Fremont, CA 94539.**

Phone/Fax No: **(510)739-3777/(510)608-4555**

hereby declares that the product

**Product Name : Motherboard**

**Model Number : SABERTOOTH X79**

Conforms to the following specifications:

- FCC Part 15, Subpart B, Unintentional Radiators
- FCC Part 15, Subpart C, Intentional Radiators
- FCC Part 15, Subpart E, Intentional Radiators

### Supplementary Information:

This device complies with part 15 of the FCC Rules. Operation is subject to the following two conditions: (1) This device may not cause harmful interference, and (2) This device must accept any interference received, including interference that may cause undesired operation.

Representative Person's Name : Steve Chang / President

*Steve Chang*

Signature : \_\_\_\_\_  
Date :   Sep. 16, 2011  

Ver. 110101

# EC Declaration of Conformity



We, the undersigned,

Manufacturer: ASUSTEK COMPUTER INC.  
Address, City: 4F, No. 150, LI-FE RD., PEITOU, TAIPEI 112, TAIWAN  
Country: TAIWAN  
Authorized representative in Europe: ASUS COMPUTER GmbH  
Address, City: HARKORT STR. 7, D-3-40860 RATINGEN  
Country: GERMANY

declare the following apparatus:

Product name : Motherboard  
Model name : SABERTOOTH X79

conform with the essential requirements of the following directives:

2004/108/EC EMC Directive  
 EN 55022:2005+A1:2007  
 EN 61000-3-2:2006-A2:2009  
 EN 55013:2001+A1:2003-A2:2006  
 EN 55022:2007-A1:2011  
 EN 55022:2007-A1:2011

1989/5/EEC R & TTE Directive  
 EN 300 328 V1.7.1 (2006-10)  
 EN 300 440-2 V1.4.1 (2010-09)  
 EN 300 440-2 V1.4.1 (2010-09)  
 EN 300 489-4 V1.4.1 (2009-05)  
 EN 300 489-4 V1.4.1 (2009-05)  
 EN 301 511 V6.0.2 (2003-03)  
 EN 301 511 V6.0.2 (2003-03)  
 EN 301 885 V1.6.2 (2011-11)  
 EN 301 885 V1.6.2 (2011-11)  
 EN 302 023 V1.1 (2009-01)  
 EN 302 023 V1.1 (2009-01)  
 EN 300 330-1 V1.7.1 (2010-02)  
 EN 300 330-1 V1.7.1 (2010-02)  
 EN 50365 V2.0  
 EN 50365 V2.0  
 EN 62479-2:2010  
 EN 62479-2:2010

2006/98/EC LVD Directive  
 EN 60950-1 /A11:2009  
 EN 60950-1 /A12:2011  
 EN 60965:2002 /A2:2010  
 EN 60965:2002 /A12:2011

2009/125/EC ErP Directive  
 Regulation (EC) No. 1275/2008  
 Regulation (EC) No. 642/2009  
 Regulation (EC) No. Z/19/2009

2011/65/EU RoHS Directive  
 CE marking



(EC conformity marking)

Ver. 110101

Position : CEO  
Name : Jerry Shen

*Jerry Shen*

Signature : \_\_\_\_\_

Declaration Date: Jan. 04, 2013  
Year to begin affixing CE marking: 2013