

**H97I-PLUS**

**ASUS**<sup>®</sup>

**Motherboard**

**Copyright © 2014 ASUSTeK COMPUTER INC. All Rights Reserved.**

No part of this manual, including the products and software described in it, may be reproduced, transmitted, transcribed, stored in a retrieval system, or translated into any language in any form or by any means, except documentation kept by the purchaser for backup purposes, without the express written permission of ASUSTeK COMPUTER INC. ("ASUS").

Product warranty or service will not be extended if: (1) the product is repaired, modified or altered, unless such repair, modification or alteration is authorized in writing by ASUS; or (2) the serial number of the product is defaced or missing.

ASUS PROVIDES THIS MANUAL "AS IS" WITHOUT WARRANTY OF ANY KIND, EITHER EXPRESS OR IMPLIED, INCLUDING BUT NOT LIMITED TO THE IMPLIED WARRANTIES OR CONDITIONS OF MERCHANTABILITY OR FITNESS FOR A PARTICULAR PURPOSE. IN NO EVENT SHALL ASUS, ITS DIRECTORS, OFFICERS, EMPLOYEES OR AGENTS BE LIABLE FOR ANY INDIRECT, SPECIAL, INCIDENTAL, OR CONSEQUENTIAL DAMAGES (INCLUDING DAMAGES FOR LOSS OF PROFITS, LOSS OF BUSINESS, LOSS OF USE OR DATA, INTERRUPTION OF BUSINESS AND THE LIKE), EVEN IF ASUS HAS BEEN ADVISED OF THE POSSIBILITY OF SUCH DAMAGES ARISING FROM ANY DEFECT OR ERROR IN THIS MANUAL OR PRODUCT.

SPECIFICATIONS AND INFORMATION CONTAINED IN THIS MANUAL ARE FURNISHED FOR INFORMATIONAL USE ONLY, AND ARE SUBJECT TO CHANGE AT ANY TIME WITHOUT NOTICE, AND SHOULD NOT BE CONSTRUED AS A COMMITMENT BY ASUS. ASUS ASSUMES NO RESPONSIBILITY OR LIABILITY FOR ANY ERRORS OR INACCURACIES THAT MAY APPEAR IN THIS MANUAL, INCLUDING THE PRODUCTS AND SOFTWARE DESCRIBED IN IT.

Products and corporate names appearing in this manual may or may not be registered trademarks or copyrights of their respective companies, and are used only for identification or explanation and to the owners' benefit, without intent to infringe.

**Offer to Provide Source Code of Certain Software**

This product contains copyrighted software that is licensed under the General Public License ("GPL"), under the Lesser General Public License Version ("LGPL") and/or other Free Open Source Software Licenses. Such software in this product is distributed without any warranty to the extent permitted by the applicable law. Copies of these licenses are included in this product.

Where the applicable license entitles you to the source code of such software and/or other additional data, you may obtain it for a period of three years after our last shipment of the product, either

(1) for free by downloading it from <http://support.asus.com/download>  
or

(2) for the cost of reproduction and shipment, which is dependent on the preferred carrier and the location where you want to have it shipped to, by sending a request to:

ASUSTeK Computer Inc.  
Legal Compliance Dept.  
15 Li Te Rd.,  
Beitou, Taipei 112  
Taiwan

In your request please provide the name, model number and version, as stated in the About Box of the product for which you wish to obtain the corresponding source code and your contact details so that we can coordinate the terms and cost of shipment with you.

The source code will be distributed WITHOUT ANY WARRANTY and licensed under the same license as the corresponding binary/object code.

This offer is valid to anyone in receipt of this information.

ASUSTeK is eager to duly provide complete source code as required under various Free Open Source Software licenses. If however you encounter any problems in obtaining the full corresponding source code we would be much obliged if you give us a notification to the email address [gpl@asus.com](mailto:gpl@asus.com), stating the product and describing the problem (please DO NOT send large attachments such as source code archives, etc. to this email address).

# Contents

Safety information.....	iv
About this guide.....	iv
Package contents.....	vi
H97I-PLUS specifications summary.....	vi
<b>Chapter 1: Product introduction</b>	
1.1 Before you proceed .....	1-1
1.2 Motherboard overview.....	1-2
1.3 Central Processing Unit (CPU) .....	1-4
1.4 System memory .....	1-8
1.5 Expansion slots .....	1-10
1.6 Headers.....	1-11
1.7 Connectors .....	1-12
1.8 Onboard buttons and switches .....	1-20
1.9 Onboard LEDs.....	1-21
1.10 Software support .....	1-22
<b>Chapter 2: BIOS information</b>	
2.1 Managing and updating your BIOS .....	2-1
2.2 BIOS setup program .....	2-6
2.3 My Favorites .....	2-15
2.4 Main menu .....	2-17
2.5 Ai Tweaker menu.....	2-19
2.6 Advanced menu .....	2-29
2.7 Monitor menu .....	2-38
2.8 Boot menu .....	2-41
2.9 Tool menu .....	2-47
2.10 Exit menu.....	2-48
<b>Appendices</b>	
Notices .....	A-1
ASUS contact information.....	A-3

# Safety information

## Electrical safety

- To prevent electrical shock hazard, disconnect the power cable from the electrical outlet before relocating the system.
- When adding or removing devices to or from the system, ensure that the power cables for the devices are unplugged before the signal cables are connected. If possible, disconnect all power cables from the existing system before you add a device.
- Before connecting or removing signal cables from the motherboard, ensure that all power cables are unplugged.
- Seek professional assistance before using an adapter or extension cord. These devices could interrupt the grounding circuit.
- Ensure that your power supply is set to the correct voltage in your area. If you are not sure about the voltage of the electrical outlet you are using, contact your local power company.
- If the power supply is broken, do not try to fix it by yourself. Contact a qualified service technician or your retailer.

## Operation safety

- Before installing the motherboard and adding components, carefully read all the manuals that came with the package.
- Before using the product, ensure all cables are correctly connected and the power cables are not damaged. If you detect any damage, contact your dealer immediately.
- To avoid short circuits, keep paper clips, screws, and staples away from connectors, slots, sockets and circuitry.
- Avoid dust, humidity, and temperature extremes. Do not place the product in any area where it may be exposed to moisture.
- Place the product on a stable surface.
- If you encounter technical problems with the product, contact a qualified service technician or your retailer.

## About this guide

This user guide contains the information you need when installing and configuring the motherboard.

## How this guide is organized

This guide contains the following parts:

- **Chapter 1: Product introduction**  
This chapter describes the features of the motherboard and the new technology it supports. It includes descriptions of the switches, jumpers, and connectors on the motherboard.
- **Chapter 2: BIOS information**  
This chapter discusses changing system settings through the BIOS Setup menus. Detailed descriptions for the BIOS parameters are also provided.

## Where to find more information

Refer to the following sources for additional information and for product and software updates.

### 1. ASUS websites

The ASUS website provides updated information on ASUS hardware and software products. Refer to the ASUS contact information.

### 2. Optional documentation

Your product package may include optional documentation, such as warranty flyers, that may have been added by your dealer. These documents are not part of the standard package.

## Conventions used in this guide

To ensure that you perform certain tasks properly, take note of the following symbols used throughout this manual.



**DANGER/WARNING:** Information to prevent injury to yourself when completing a task.



**CAUTION:** Information to prevent damage to the components when completing a task



**IMPORTANT:** Instructions that you **MUST** follow to complete a task.



**NOTE:** Tips and additional information to help you complete a task.

## Typography

**Bold text**

Indicates a menu or an item to select.

*Italics*

Used to emphasize a word or a phrase.

<Key>

Keys enclosed in the less-than and greater-than sign means that you must press the enclosed key.

Example: <Enter> means that you must press the Enter or Return key.

<Key1> + <Key2> + <Key3>

If you must press two or more keys simultaneously, the key names are linked with a plus sign (+).

## Package contents

Check your motherboard package for the following items.

<b>Motherboard</b>	ASUS H97I-PLUS motherboard
<b>Cables</b>	2 x Serial ATA 6.0 Gb/s cables
<b>Accessories</b>	1 x I/O Shield
<b>Application DVD</b>	Support DVD
<b>Documentation</b>	User Guide



If any of the above items is damaged or missing, contact your retailer.

## H97I-PLUS specifications summary

<b>CPU</b>	LGA1150 socket for 4th Generation, New 4th Generation and 5th Generation Intel® Core™ i7 / Core™ i5 / Core™ i3, Pentium®, and Celeron® processors Supports 22nm CPU Supports Intel® Turbo Boost Technology 2.0*  * The Intel® Turbo Boost Technology 2.0 support depends on the CPU types.
<b>Chipset</b>	Intel® H97 Express Chipset
<b>Memory</b>	2 x DIMM, max. 16GB, DDR3 1600 / 1333 / 1066 MHz, non-ECC, unbuffered memory Dual-channel memory architecture Supports Intel® Extreme Memory Profile (XMP)  * Hyper DIMM support is subject to the physical characteristics of individual CPUs. Please refer to Memory QVL (Qualified Vendors List) for details. ** Refer to <a href="http://www.asus.com">www.asus.com</a> for the Memory QVL (Qualified Vendors List).
<b>Expansion slots</b>	1 x PCI Express 3.0 x16 slot
<b>Graphics</b>	Integrated Graphics Processor - Intel® HD Graphics support Multi-VGA output support: DisplayPort/HDMI/DVI-D/RGB port - Supports DisplayPort 1.2* with max. resolution of 4096 x 2160 @24Hz/ 3840 x 2160 @60Hz - Supports HDMI with max. resolution of 4096 x 2160 @24Hz / 2560 x 1600 @60Hz - Supports DVI-D with max. resolution of 1920 x 1200 @60Hz - Supports RGB with max. resolution of 1920 x 1200 @60Hz Supports Intel® InTru™ 3D, Intel® Quick Sync Video, Intel® Clear Video HD Technology, and Intel® Insider™ Supports up to three displays simultaneously Maximum shared memory of 512MB  * DisplayPort 1.2 Multi-Stream Transport compliant; supports DisplayPort 1.2 monitor daisy-chain up to 3 displays

(continued on the next page)

## H97I-PLUS specifications summary

<b>Storage</b>	<p><b>Intel® H97 Express Chipset with RAID 0, 1, 5, 10 and Intel® Rapid Storage Technology 13 support</b></p> <ul style="list-style-type: none"> <li>- 4 x SATA 6.0 Gb/s ports</li> <li>- 1 x M.2 Socket 3 with M Key, type 2260/2280 storage devices support</li> <li>- Supports Intel® Smart Response Technology, Intel® Rapid Start Technology, and Intel® Smart Connect Technology*</li> </ul> <p>* <b>These functions work depending on the CPU installed.</b></p>
<b>LAN</b>	<p>Intel® I218V Gigabit LAN- Dual interconnect between the integrated LAN controller and physical layer (PHY)</p>
<b>Audio</b>	<p>Realtek® ALC887 7.1-channel high definition audio CODEC</p> <ul style="list-style-type: none"> <li>- AMP</li> <li>- Absolute Pitch 192khz/24bit true BD lossless sound</li> <li>- BD audio layer content protection</li> <li>- Supports jack-detection and multi-streaming</li> <li>- Optical S/PDIF out ports at back I/O</li> </ul>
<b>USB</b>	<p><b>Intel® H97 Express Chipset - supports ASUS USB 3.0 Boost</b></p> <ul style="list-style-type: none"> <li>- 2 x USB 3.0/2.0 ports at mid-board for front panel support</li> <li>- 4 x USB 3.0/2.0 ports at rear panel (blue)</li> </ul> <p><b>Intel® H97 Express Chipset</b></p> <ul style="list-style-type: none"> <li>- 6 x USB 2.0/1.1 ports (2 ports at mid-board, 4 ports at rear panel)</li> </ul>
<b>ASUS unique features</b>	<p><b>High Performance</b></p> <p><b>ASUS 5X PROTECTION</b></p> <ul style="list-style-type: none"> <li>- ASUS motherboards safeguard your PC with 5X Protection: DIGI+VRM, DRAM Fuse, ESD Guards, High-Quality Solid Capacitors, and Stainless Steel Back I/O to ensure the best quality, reliability, and durability</li> </ul> <p><b>DIGI+ Power Control</b></p> <ul style="list-style-type: none"> <li>- ASUS 6 Phase Power Design</li> </ul> <p><b>ASUS DRAM Fuse</b></p> <ul style="list-style-type: none"> <li>- Enhanced DRAM overcurrent protection and short circuit damage prevention</li> </ul> <p><b>ASUS ESD Guards</b></p> <ul style="list-style-type: none"> <li>- Strong ESD protection for extended component lifespan</li> </ul> <p><b>ASUS High-Quality Solid Capacitors</b></p> <ul style="list-style-type: none"> <li>- 2.5x Longer lifespan with excellent durability</li> </ul> <p><b>ASUS Stainless Steel Back I/O</b></p> <ul style="list-style-type: none"> <li>- 3x More durable corrosion-resistant coating</li> </ul> <p><b>Gaming Scenario</b></p> <p><b>ASUS audio features:</b> Feel the sound power with different usage scenarios</p> <p><b>Steam OS Support</b></p>

(continued on the next page)

# H97I-PLUS specifications summary

<b>ASUS unique features</b>	<b>Interactive HomeCloud</b> <b>Media Streamer</b> <ul style="list-style-type: none"><li>- Pipe music or movies from your PC to a smart TV</li><li>- Media Streamer app for portable smartphone/tablet, supporting Android™ 4.0 and iOS® 7 systems</li></ul> <b>Remote GO!</b> <ul style="list-style-type: none"><li>- Remote GO! Function: Cloud GO!, Remote Desktop, Remote Keyboard &amp; Mouse, File Transfer</li><li>- Wi-Fi GO! &amp; NFC Remote app for portable smart phone, tablet devices supporting Android™ 4.0 and iOS® 7 systems</li></ul> <b>Exclusive Features</b> <ul style="list-style-type: none"><li>- USB 3.0 Boost featuring speedy USB 3.0 transmission</li><li>- Ai Charger</li><li>- Disk Unlocker</li><li>- AI Suite 3</li><li>- Anti Surge</li><li>- MemOK!</li></ul> <b>ASUS Quiet Thermal Solution</b> <ul style="list-style-type: none"><li>- ASUS Fan Xpert 2+ featuring Fan Auto Tuning function for optimized speed control</li></ul> <b>ASUS EZ DIY</b> <ul style="list-style-type: none"><li>- <b>Push Notice</b><ul style="list-style-type: none"><li>- Monitor your PC status with smart devices in real time</li></ul></li><li>- <b>UEFI BIOS EZ Mode</b><ul style="list-style-type: none"><li>- featuring friendly graphics user interface</li><li>- ASUS CrashFree BIOS 3</li><li>- ASUS EZ Flash 2</li></ul></li></ul> <b>ASUS Q-Design</b> <ul style="list-style-type: none"><li>- ASUS Q-Slot</li><li>- ASUS Q-DIMM</li></ul>
<b>Rear panel I/O ports</b>	1 x PS/2 mouse / keyboard combo port 1 x HDMI port 1 x DVI-D port 1 x D-Sub port 1 x DisplayPort 1 x Optical S/PDIF Out port 1 x LAN (RJ-45) port 4 x USB 3.0/2.0 ports (blue) 4 x USB 2.0/1.1 ports 3-jack 7.1-channel audio I/O ports

(continued on the next page)



## H97I-PLUS specifications summary

<b>Internal connectors</b>	1 x 19-pin USB 3.0/2.0 connector supports additional 2 USB ports 1 x USB 2.0/1.1 connector supports additional 2 USB ports 1 x M.2 Socket 3 4 x SATA 6.0 Gb/s connectors (gray) 1 x 4-pin CPU Fan connector for 4-pin (PWM mode) CPU cooler control 2 x 4-pin Chassis Fan connectors for both 3-pin (DC mode) and 4-pin (PWM mode) coolers control 1 x Front panel audio connector (AAFP) 1 x S/PDIF out header 1 x 24-pin EATX Power connector 1 x 8-pin EATX 12V Power connector 1 x System panel connector 1 x MemOK! button 1 x Speaker connector 1 x 2-pin Clear CMOS header 1 x TPM header
<b>BIOS features</b>	64 Mb Flash ROM, UEFI AMI BIOS, PnP, DMI 2.0, WfM 2.0, SM BIOS 2.8, ACPI 2.0a, Multi-language BIOS, ASUS EZ Flash 2, ASUS CrashFree BIOS 3, My Favorites, Quick Note, Last Modified Log, F12 PrintScreen function, F3 Shortcut functions, and ASUS DRAM SPD (Serial Presence Detect) memory information
<b>Manageability</b>	WfM 2.0, DMI 2.0, WOL by PME, PXE
<b>Support DVD</b>	Drivers ASUS utilities EZ Update Anti-virus software (OEM version)
<b>OS support</b>	Windows® 8.1 Windows® 8 Windows® 7
<b>Form factor</b>	Mini-ITX form factor: 6.7 in. x 6.7 in. (17.0 cm x 17.0 cm)



Specifications are subject to change without notice.



# Product introduction

# 1

## 1.1 Before you proceed

Take note of the following precautions before you install motherboard components or change any motherboard settings.



- 
- Unplug the power cord from the wall socket before touching any component.
  - Before handling components, use a grounded wrist strap or touch a safely grounded object or a metal object, such as the power supply case, to avoid damaging them due to static electricity.
  - Hold components by the edges to avoid touching the ICs on them.
  - Whenever you uninstall any component, place it on a grounded antistatic pad or in the bag that came with the component.
  - Before you install or remove any component, ensure that the ATX power supply is switched off or the power cord is detached from the power supply. Failure to do so may cause severe damage to the motherboard, peripherals, or components.
-

## 1.2 Motherboard overview

Before you install the motherboard, study the configuration of your chassis to ensure that the motherboard fits.



Unplug the power cord before installing or removing the motherboard. Failure to do so can cause you physical injury and damage to motherboard components.

### 1.2.1 Placement direction

When installing the motherboard, place it into the chassis in the correct orientation. The edge with external ports goes to the rear part of the chassis as indicated in the image.

### 1.2.2 Screw holes

Place six screws into the holes indicated by circles to secure the motherboard to the chassis.



Do not overtighten the screws! Doing so can damage the motherboard.

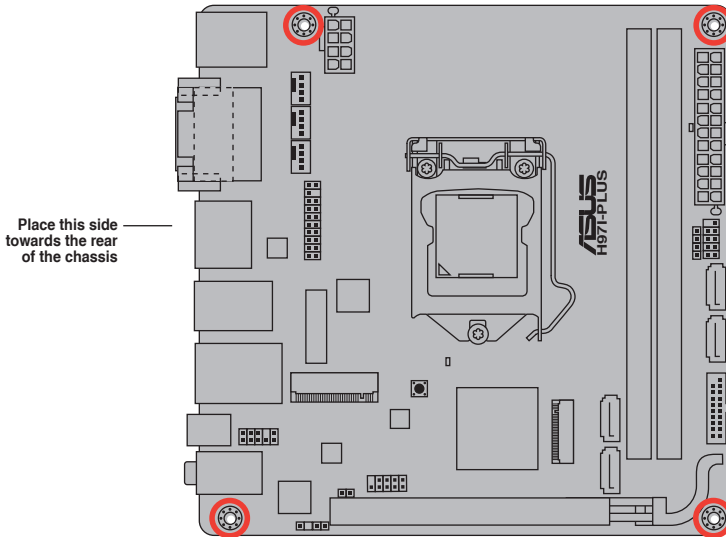

## 1.2.3 Motherboard layout

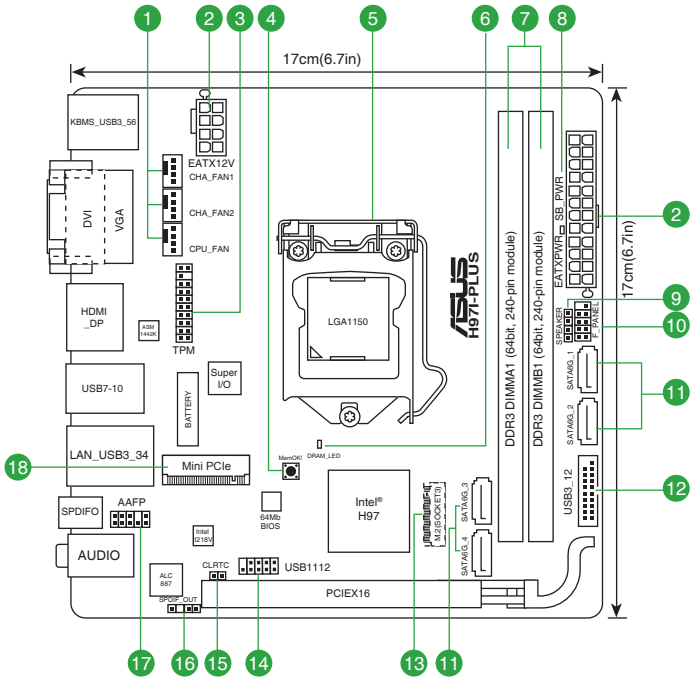

## 1.2.4 Layout contents

Connectors/Headers/Slots/LEDs	Page
1. CPU and chassis fan connectors (4-pin CPU_FAN, 4-pin CHA_FAN1/2)	1-16
2. ATX power connectors (24-pin EATXPWR, 8-pin EATX12V)	1-18
3. TPM header (20-1 pin TPM)	1-18
4. MemOK! button	1-20
5. LGA1150 CPU socket	1-4
6. DRAM LED (DRAM_LED)	1-21
7. DDR3 DIMM slots	1-8
8. Standby power LED (SB_PWR)	1-21
9. Speaker connector (4-pin SPEAKER)	1-16
10. System panel connector (10-1 pin F_PANEL)	1-19
11. Intel® H97 Serial ATA 6.0 Gb/s connectors (7-pin SATA6G_1-4)	1-14
12. USB 3.0 connector (20-1 pin USB3_12)	1-15
13. M.2 Socket 3	1-17
14. USB 2.0 connector (10-1 pin USB1112)	1-15
15. Clear RTC RAM (2-pin CLRTC)	1-11
16. Digital audio connector (4-1 pin SPDIF_OUT)	1-14
17. Front panel audio connector (10-1 pin AAFP)	1-17
18. Mini PCIe slot	1-19

## 1.3 Central Processing Unit (CPU)

This motherboard comes with a surface mount LGA1150 socket designed for the 4th Generation, New 4th Generation and 5th Generation Intel® Core™ i7 / Core™ i5 / Core™ i3, Pentium®, Celeron® processors.

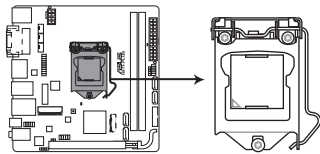

**H97I-PLUS CPU socket LGA1150**



Unplug all power cables before installing the CPU.



- Upon purchase of the motherboard, ensure that the PnP cap is on the socket and the socket contacts are not bent. Contact your retailer immediately if the PnP cap is missing, or if you see any damage to the PnP cap/socket contacts/motherboard components.
- Keep the cap after installing the motherboard. ASUS will process Return Merchandise Authorization (RMA) requests only if the motherboard comes with the cap on the LGA1150 socket.
- The product warranty does not cover damage to the socket contacts resulting from incorrect CPU installation/removal, or misplacement/loss/incorrect removal of the PnP cap.

### 1.3.1 Installing the CPU

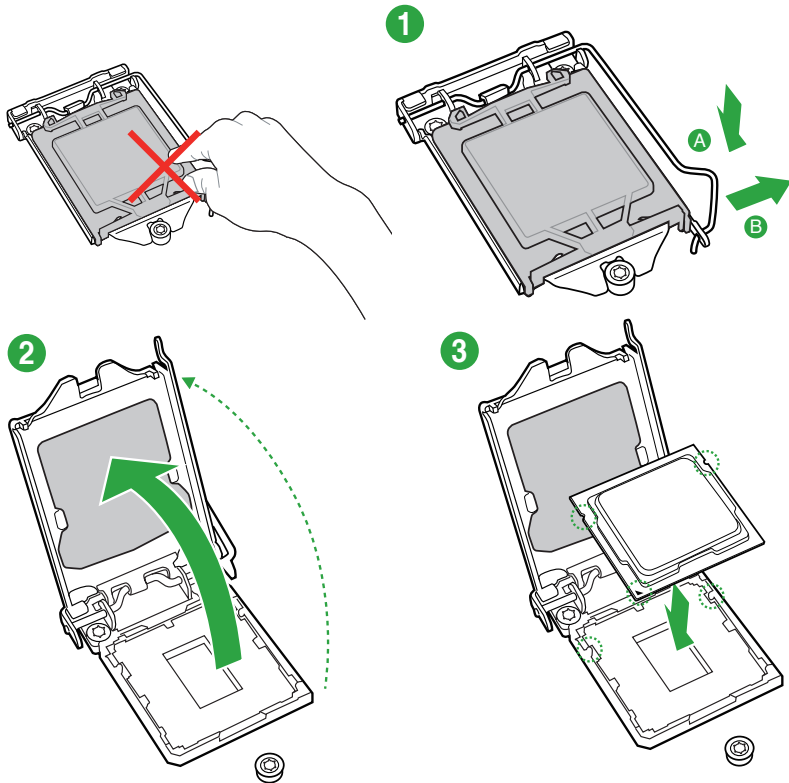

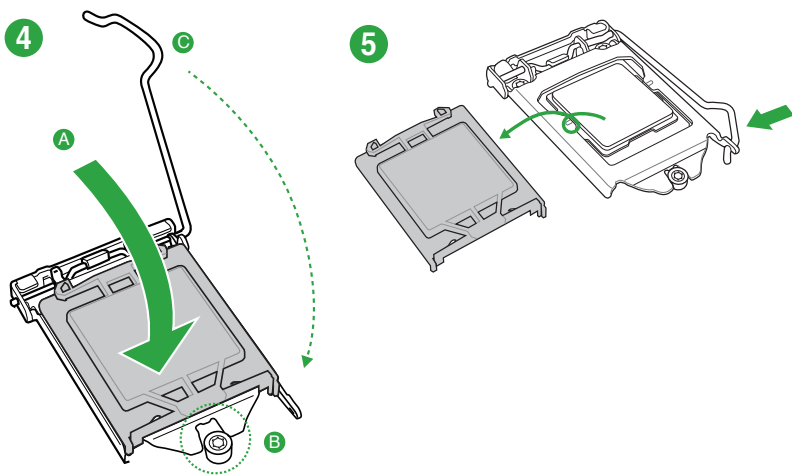

### 1.3.2 CPU heatsink and fan assembly installation

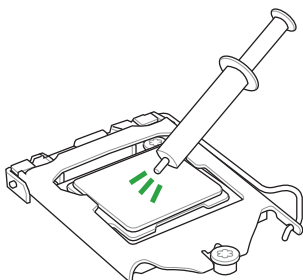

Apply the Thermal Interface Material to the CPU heatsink and CPU before you install the heatsink and fan if necessary.



### To install the CPU heatsink and fan assembly

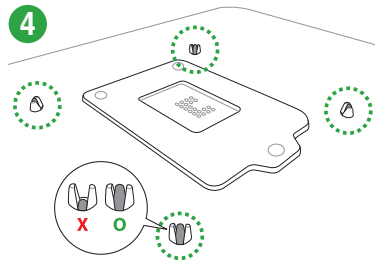
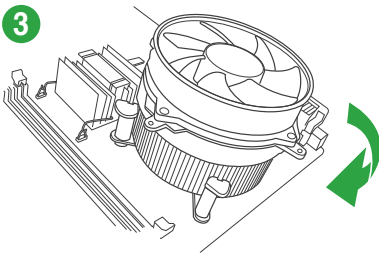
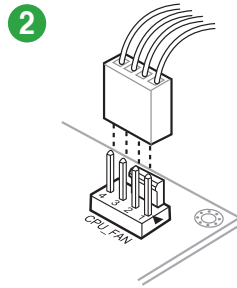
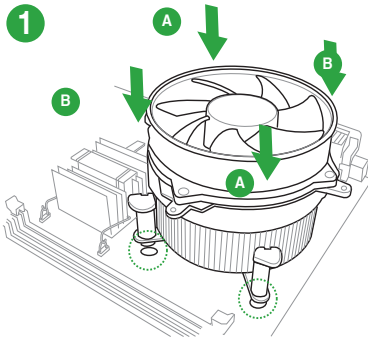

### To uninstall the CPU heatsink and fan assembly

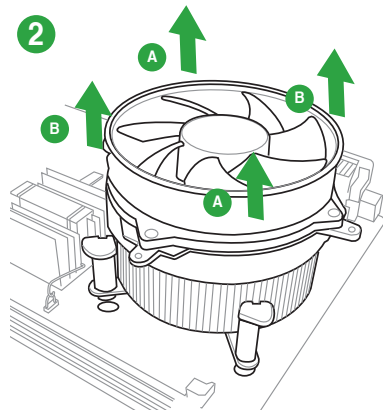
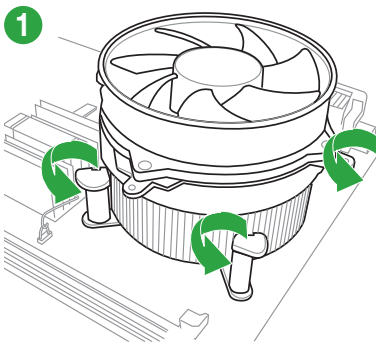

## 1.4 System memory

### 1.4.1 Overview

This motherboard comes with two Double Data Rate 3 (DDR3) Dual Inline Memory Module (DIMM) sockets. The figure illustrates the location of the DDR3 DIMM sockets:

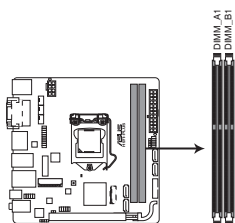

H971-PLUS 240-pin DDR3 DIMM sockets

Channel	Sockets
Channel A	DIMM_A1
Channel B	DIMM_B1

### 1.4.2 Memory configurations

You may install 1GB, 2GB, 4GB, and 8GB unbuffered non-ECC DDR3 DIMMs into the DIMM sockets.



- You may install varying memory sizes in Channel A and Channel B. The system maps the total size of the lower-sized channel for the dual-channel configuration. Any excess memory from the higher-sized channel is then mapped for single-channel operation.
- According to Intel CPU spec, DIMM voltage below 1.65V is recommended to protect the CPU.
- Always install DIMMs with the same CAS latency. For optimal compatibility, we recommend that you install memory modules of the same version or date code (D/C) from the same vendor. Check with the retailer to get the correct memory modules.
- Due to the memory address limitation on 32-bit Windows® OS, when you install 4GB or more memory on the motherboard, the actual usable memory for the OS can be about 3GB or less. For effective use of memory, we recommend that you do any of the following:
  - Use a maximum of 3GB system memory if you are using a 32-bit Windows® OS.
  - Install a 64-bit Windows® OS if you want to install 4GB or more on the motherboard.
  - For more details, refer to the Microsoft® support site at <http://support.microsoft.com/kb/929605/en-us>.
- This motherboard does not support DIMMs made up of 512 megabits (Mb) chips or less.



- The default memory operation frequency is dependent on its Serial Presence Detect (SPD), which is the standard way of accessing information from a memory module. Under the default state, some memory modules for overclocking may operate at a lower frequency than the vendor-marked value. To operate at the vendor-marked or at a higher frequency, refer to section **2.5 Ai Tweaker menu** for manual memory frequency adjustment.
- For system stability, use a more efficient memory cooling system to support a full memory load or overclocking condition.
- Visit the ASUS website at: [www.asus.com](http://www.asus.com) for the latest QVL.

### 1.4.3 Installing a DIMM

1

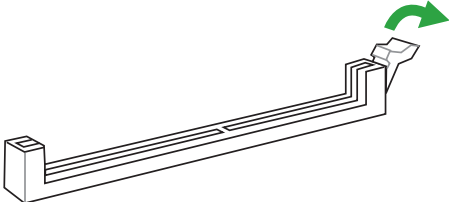

2

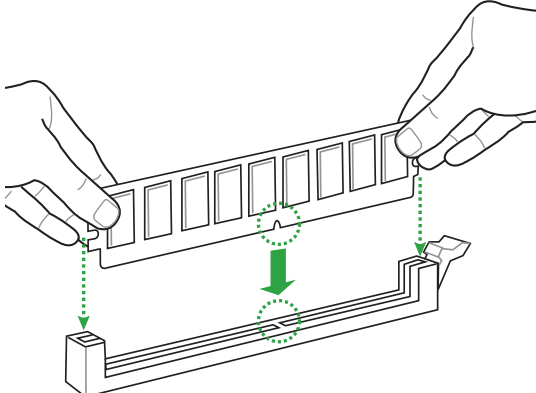

3

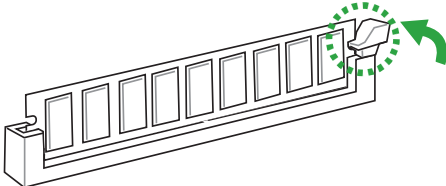

### To remove a DIMM

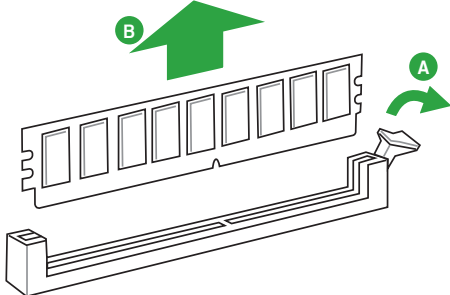

## 1.5 Expansion slots

In the future, you may need to install expansion cards. The following sub-sections describe the slots and the expansion cards that they support.



---

Unplug the power cord before adding or removing expansion cards. Failure to do so may cause you physical injury and damage motherboard components.

---

### 1.5.1 Installing an expansion card

**To install an expansion card:**

1. Before installing the expansion card, read the documentation that came with it and make the necessary hardware settings for the card.
2. Remove the system unit cover (if your motherboard is already installed in a chassis).
3. Remove the bracket opposite the slot that you intend to use. Keep the screw for later use.
4. Align the card connector with the slot and press firmly until the card is completely seated on the slot.
5. Secure the card to the chassis with the screw you removed earlier.
6. Replace the system cover.

### 1.5.2 Configuring an expansion card

After installing the expansion card, configure it by adjusting the software settings.

1. Turn on the system and change the necessary BIOS settings, if any. See Chapter 2 for information on BIOS setup.
2. Assign an IRQ to the card.
3. Install the software drivers for the expansion card.



---

When using PCI cards on shared slots, ensure that the drivers support "Share IRQ" or that the cards do not need IRQ assignments. Otherwise, conflicts will arise between the two PCI groups, making the system unstable and the card inoperable.

---

### 1.5.3 PCI Express 3.0/2.0 x16 slot

This motherboard has a PCI Express 3.0/2.0 x16 slot that supports PCI Express 3.0/2.0 x16 graphic cards complying with the PCI Express specifications.

## IRQ assignments for this motherboard

	A	B	C	D	E	F	G	H
PCIEx16	shared	shared	shared	shared	-	-	-	-
Intel I218V controller	-	-	-	-	shared	-	-	-
USB2.0 controller 1	-	-	-	-	-	-	-	shared
USB2.0 controller 2	shared	-	-	-	-	-	-	-
HD audio	-	-	-	-	-	-	shared	-
SATA controller 1	-	-	-	shared	-	-	-	-
SATA controller 2	-	-	-	shared	-	-	-	-
XHCI controller	-	-	-	-	-	shared	-	-

## 1.6 Headers

### Clear RTC RAM (2-pin CLRRTC)

This header allows you to clear the Real Time Clock (RTC) RAM in CMOS. You can clear the CMOS memory of date, time, and system setup parameters by erasing the CMOS RTC RAM data. The onboard button cell battery powers the RAM data in CMOS, which include system setup information such as system passwords.

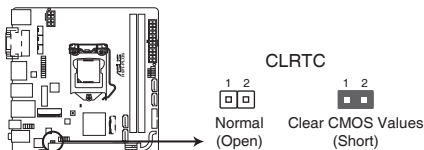

### H971-PLUS Clear RTC RAM

#### To erase the RTC RAM:

1. Turn OFF the computer and unplug the power cord.
2. Use a metal object such as a screwdriver to short the two pins.
3. Plug the power cord and turn ON the computer.
4. Hold down the <Del> key during the boot process and enter BIOS setup to re-enter data.



- If the steps above do not help, remove the onboard battery and short the two pins again to clear the CMOS RTC RAM data. After clearing the CMOS, reinstall the battery.
- You do not need to clear the RTC when the system hangs due to overclocking. For system failure due to overclocking, use the CPU Parameter Recall (C.P.R.) feature. Shut down and reboot the system, then the BIOS automatically resets parameter settings to default values.

# 1.7 Connectors

## 1.7.1 Rear panel connectors

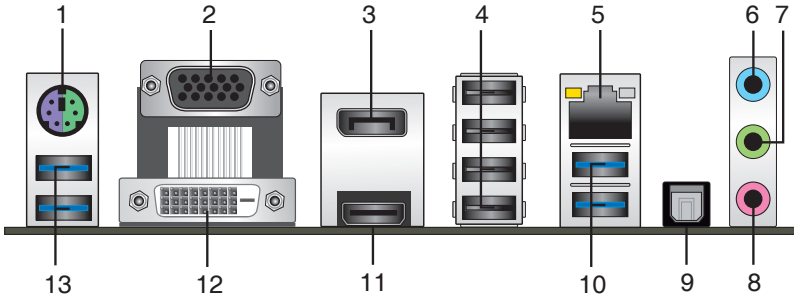

1. **PS/2 Mouse/Keyboard combo port.** This port connects to a PS/2 mouse or PS/2 keyboard.
2. **Video Graphics Adapter (VGA) port.** This 15-pin port is for a VGA monitor or other VGA-compatible devices.
3. **DisplayPort.** This port connects a display monitor or a home-theater system.
4. **USB 2.0 ports 7 ~ 10.** These 4-pin Universal Serial Bus (USB) ports are available for connecting USB 2.0/1.1 devices.
5. **LAN (RJ-45) port.** These ports allow Gigabit connection to a Local Area Network (LAN) through a network hub.

### LAN port LED indications

Activity/Link LED		Speed LED	
Status	Description	Status	Description
Off	No link	OFF	10Mbps connection
Orange	Linked	ORANGE	100Mbps connection
Orange (Blinking)	Data activity	GREEN	1Gbps connection
Orange (Blinking then steady)	Ready to wake up from S5 mode	—	—

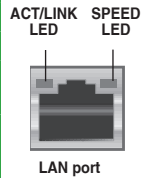

6. **Line In port (light blue).** This port connects to the tape, CD, DVD player, or other audio sources.
7. **Line Out port (lime).** This port connects to a headphone or a speaker. In the 4.1, 5.1, and 7.1-channel configurations, the function of this port becomes Front Speaker Out.
8. **Microphone port (pink).** This port connects to a microphone.



Refer to the audio configuration table on the next page for the function of the audio ports in 2.1, 4.1, 5.1, or 7.1-channel configuration.

## Audio 2.1, 4.1, 5.1, or 7.1-channel configuration

Port	Headset 2.1-channel	4.1-channel	5.1-channel	7.1-channel
Light Blue (Rear panel)	Line In	Rear Speaker Out	Rear Speaker Out	Rear Speaker Out
Lime (Rear panel)	Line Out	Front Speaker Out	Front Speaker Out	Front Speaker Out
Pink (Rear panel)	Mic In	Mic In	Bass/Center	Bass/Center
Lime (Front panel)	–	–	–	Side Speaker Out



### To configure a 7.1-channel audio output:

Use a chassis with HD audio module in the front panel to support a 7.1-channel audio output.

- Optical S/PDIF Out port.** This port connects an external audio output device via an optical S/PDIF cable.
- USB 3.0 ports 3 and 4.** These 9-pin Universal Serial Bus (USB) ports connect to USB 3.0/2.0 devices.



- DO NOT connect a keyboard / mouse to any USB 3.0 port when installing Windows® operating system.
- Due to USB 3.0 controller limitation, USB 3.0 devices can only be used under Windows® OS environment and after the USB 3.0 driver installation.
- USB 3.0 devices can only be used as data storage only.
- We strongly recommend that you connect USB 3.0 devices to USB 3.0 ports for faster and better performance for your USB 3.0 devices.

- HDMI port.** This port is for a High-Definition Multimedia Interface (HDMI) connector, and is HDCP compliant allowing playback of HD DVD, Blu-ray, and other protected content.
- DVI-D port.** This port is for any DVI-D compatible device. DVI-D can't be converted to output RGB Signal to CRT and isn't compatible with DVI-I.



- Multi-VGA output supports up to three displays under Windows® OS environment, two displays under BIOS, and one display under DOS.
- Intel® display architecture design supports the following maximum supported pixel clocks (Pixel Clock = H total x V Total x Frame Rate (Screen refresh rate)):
  - DVI port supports: 165 MHz
  - DisplayPort supports: 533 MHz
  - HDMI port supports: 300 MHz

- USB 3.0 ports 5 and 6.** These 9-pin Universal Serial Bus (USB) ports connect to USB 3.0/2.0 devices.

## 1.7.2 Internal connectors

### 1. Intel® H97 Serial ATA 6.0 Gb/s connectors (7-pin SATA6G\_1-4)

These connectors connect to Serial ATA 6.0 Gb/s hard disk drives via Serial ATA 6.0 Gb/s signal cables.

If you installed Serial ATA hard disk drives, you can create a RAID 0, 1, 5, and 10 configuration with the Intel® Rapid Storage Technology through the onboard Intel® H97 chipset.

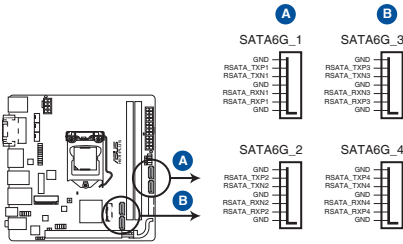

**H97I-PLUS SATA 6.0Gb/s connectors**



- These connectors are set to **[AHCI]** by default. If you intend to create a Serial ATA RAID set using these connectors, set the SATA Mode Selection item in the BIOS to **[RAID]**. Refer to section **2.6.3 PCH Storage Configuration** for details.
- Before creating a RAID set, refer to the guide bundled in the motherboard support DVD.
- When using hot-plug and NCQ, set the type of the SATA connectors in the BIOS to **[AHCI]**. See section **2.6.3 PCH Storage Configuration** for details.

### 2. Digital audio connector (4-1 pin SPDIF\_OUT)

This connector is for an additional Sony/Philips Digital Interface (S/PDIF) port. Connect the S/PDIF Out module cable to this connector, then install the module to a slot opening at the back of the system chassis.

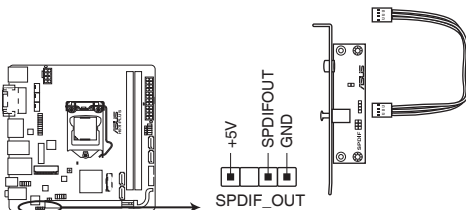

**H97I-PLUS Digital audio connector**



The S/PDIF module is purchased separately.



### 3. USB 3.0 connector (20-1 pin USB3\_12)

This connector allows you to connect a USB 3.0 module for additional USB 3.0 front or rear panel ports. With an installed USB 3.0 module, you can enjoy all the benefits of USB 3.0 including faster data transfer speeds of up to 4.8Gbps, faster charging time for USB-chargable devices, optimized power efficiency, and backward compatibility with USB 2.0.

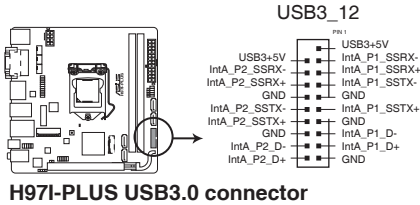

**H971-PLUS USB3.0 connector**



- The USB 3.0 module is purchased separately.
- These connectors are based on xHCI specification. We recommend you to install the related driver to fully use the USB 3.0 ports under Windows® 7.
- The plugged USB 3.0 device may run on xHCI or EHCI mode depending on the operating system's setting.
- These USB 3.0 ports only support Turbo Mode when using USB 3.0 Boost feature.

### 4. USB 2.0 connector (10-1 pin USB1112)

This connector is for USB 2.0 ports. Connect the USB module cable to this connector, then install the module to a slot opening at the back of the system chassis. This USB connector complies with USB 2.0 specification that supports up to 480 Mbps connection speed.

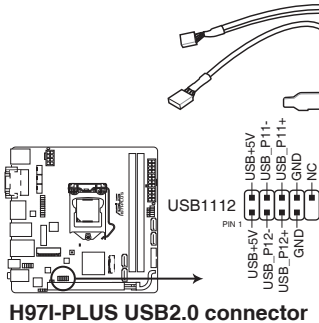

**H971-PLUS USB2.0 connector**



Never connect a 1394 cable to the USB connector. Doing so will damage the motherboard!



The USB 2.0 module is purchased separately.

**5. CPU and chassis fan connectors (4-pin CPU\_FAN; 4-pin CHA\_FAN1/2)**

Connect the fan cables to the fan connectors on the motherboard, ensuring that the black wire of each cable matches the ground pin of the connector.

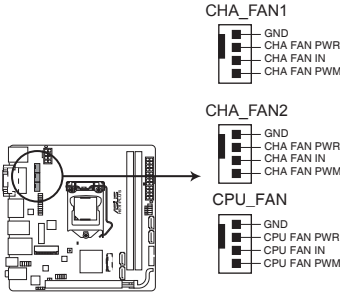

**H971-PLUS Fan connectors**



- DO NOT forget to connect the fan cables to the fan connectors. Insufficient air flow inside the system may damage the motherboard components. These are not jumpers! Do not place jumper caps on the fan connectors!
- Ensure that the CPU fan cable is securely installed to the CPU fan connector.



- The CPU\_FAN connector supports the CPU fan of maximum 1A (12 W) fan power.
- The CPU\_FAN and CHA\_FAN connectors support the ASUS FAN Xpert 2+ feature.
- The chassis fan connectors support DC and PWM modes. To set these fans to DC or PWM, go to **Advanced Mode > Monitor > Chassis Fan 1/2 Q-Fan Control** items in BIOS.

**6. Speaker connector (4- pin SPEAKER)**

This 4-pin connector is for the chassis-mounted system warning speaker. The speaker allows you to hear system beeps and warnings.

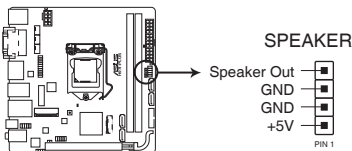

**H971-PLUS Speaker out connector**

## 7. Front panel audio connector (10-1 pin AAFP)

This connector is for a chassis-mounted front panel audio I/O module that supports either HD Audio or legacy AC'97 audio standard. Connect one end of the front panel audio I/O module cable to this connector.

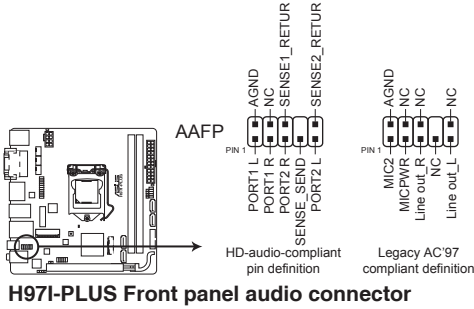

**H971-PLUS Front panel audio connector**



- We recommend that you connect a high-definition front panel audio module to this connector to avail of the motherboard's high-definition audio capability.
- If you want to connect a high-definition or an AC'97 front panel audio module to this connector, set the Front Panel Type item in the BIOS setup to **[HD Audio]** or **[AC97]**.

## 8. M.2 Socket 3

This socket allows you to install an M.2 (NGFF) SSD module.

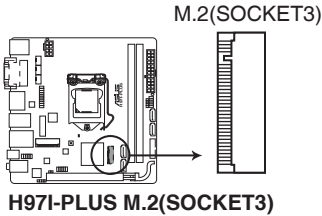

**H971-PLUS M.2(SOCKET3)**



- This socket supports M Key and type 2260/2280 storage devices.
- When using Intel® Desktop Responsiveness technologies with PCIe M.2 device, ensure to set up the Windows® UEFI operating system under RAID mode.



The M.2 (NGFF) SSD module is purchased separately.

**9. ATX power connectors (24-pin EATXPWR; 8-pin EATX12V)**

These connectors are for ATX power supply plugs. The power supply plugs are designed to fit these connectors in only one orientation. Find the proper orientation and push down firmly until the connectors completely fit.

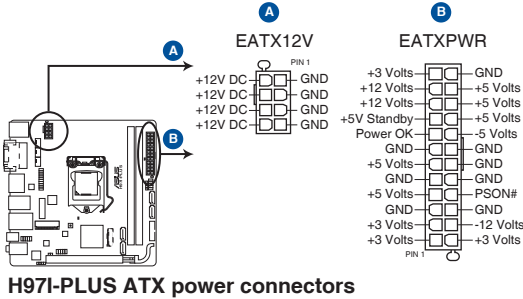

- For a fully configured system, we recommend that you use a power supply unit (PSU) that complies with ATX 12V Specification 2.0 (or later version) and provides a minimum power of 350 W.
- DO NOT forget to connect the 4-pin/8-pin EATX12V power plug. Otherwise, the system will not boot.
- We recommend that you use a PSU with a higher power output when configuring a system with more power-consuming devices. The system may become unstable or may not boot up if the power is inadequate.
- If you want to use two high-end PCI Express x16 cards, use a PSU with 1000W power or above to ensure the system stability.
- If you are uncertain about the minimum power supply requirement for your system, refer to the Recommended Power Supply Wattage Calculator at <http://support.asus.com/PowerSupplyCalculator/PSCalculator.aspx?SLanguage=en-us> for details.

**10. TPM connector (20-1 pin TPM)**

This connector supports a Trusted Platform Module (TPM) system, which securely store keys, digital certificates, passwords and data. A TPM system also helps enhance network security, protect digital identities, and ensures platform integrity.

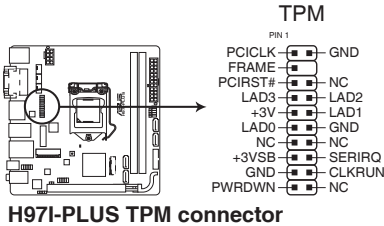

The TPM module is purchased separately.

## 11. System panel connector (10-1 pin F\_PANEL)

This connector supports several chassis-mounted functions.

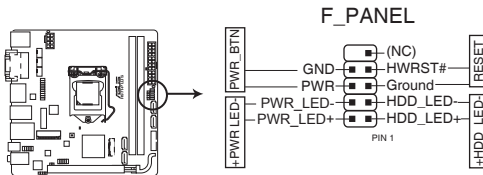

**H971-PLUS System panel connector**

- **System power LED (2-pin +PWR\_LED-)**

This 2-pin connector is for the system power LED. Connect the chassis power LED cable to this connector. The system power LED lights up when you turn on the system power, and blinks when the system is in sleep mode.

- **Hard disk drive activity LED (2-pin +HDD\_LED-)**

This 2-pin connector is for the HDD Activity LED. Connect the HDD Activity LED cable to this connector. The HDD LED lights up or flashes when data is read from or written to the HDD.

- **ATX power button/soft-off button (2-pin PWR\_BTN)**

This connector is for the system power button. Pressing the power switch for more than four seconds while the system is ON turns the system OFF.

- **Reset button (2-pin RESET)**

This 2-pin connector is for the chassis-mounted reset button for system reboot without turning off the system power.

## 12. Mini PCIe slot

This slot allows you to install a Mini PCIe module.

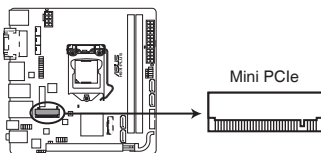

**H971-PLUS Mini PCIe slot**



The Mini PCIe module is purchased separately.

## 1.8 Onboard buttons and switches

Onboard switches and buttons allow you to fine-tune performance when working on a bare or open-case system. This is ideal for overclockers and gamers who continually change settings to enhance system performance.

### MemOK! button

Installing DIMMs that are not compatible with the motherboard may cause system boot failure, and the DRAM\_LED near the MemOK! switch lights continuously. Press and hold the MemOK! button until the DRAM\_LED starts blinking to begin automatic memory compatibility tuning for successful boot.

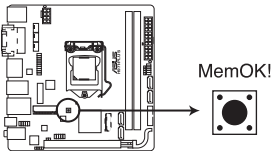

### H97I-PLUS MemOK! button



- Refer to section **1.9 Onboard LEDs** for the exact location of the DRAM\_LED.
- The DRAM\_LED also lights up when the DIMM is not properly installed. Turn off the system and reinstall the DIMM before using the MemOK! function.
- The MemOK! switch does not function under Windows® OS environment.
- During the tuning process, the system loads and tests failsafe memory settings. It takes about 30 seconds for the system to test one set of failsafe settings. If the test fails, the system reboots and test the next set of failsafe settings. The blinking speed of the DRAM\_LED increases, indicating different test processes.
- Due to memory tuning requirement, the system automatically reboots when each timing set is tested. If the installed DIMMs still fail to boot after the whole tuning process, the DRAM\_LED lights continuously. Replace the DIMMs with ones recommended in the Memory QVL (Qualified Vendors Lists) on the ASUS website at [www.asus.com](http://www.asus.com).
- If you turn off the computer and replace DIMMs during the tuning process, the system continues memory tuning after turning on the computer. To stop memory tuning, turn off the computer and unplug the power cord for about 5–10 seconds.
- If your system fails to boot up due to BIOS overclocking, press the MemOK! switch to boot and load the BIOS default settings. A message will appear during POST reminding you that the BIOS has been restored to its default settings.
- We recommend that you download and update to the latest BIOS version from the ASUS website at [www.asus.com](http://www.asus.com) after using the MemOK! function.

## 1.9 Onboard LEDs

### 1. Standby Power LED

The motherboard comes with a standby power LED that lights up to indicate that the system is ON, in sleep mode, or in soft-off mode. This is a reminder that you should shut down the system and unplug the power cable before removing or plugging in any motherboard component. The illustration below shows the location of the onboard LED.

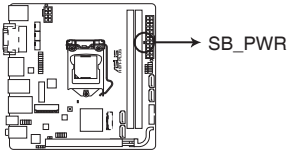

**H971-PLUS Onboard LED**

### 2. DRAM LED

DRAM LED checks the DRAM in sequence during motherboard booting process. If an error is found, the LED next to the error device will continue lighting until the problem is solved. This user-friendly design provides an intuitional way to locate the root problem within a second.

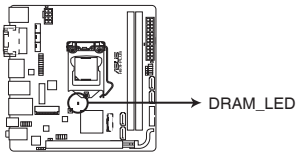

**H971-PLUS DRAM LED**

## 1.10 Software support

### 1.10.1 Installing an operating system

This motherboard supports Windows® 7 (32/64bit), Windows® 8 (32/64bit) and Windows® 8.1 (32/64bit) Operating Systems (OS). Always install the latest OS version and corresponding updates to maximize the features of your hardware.



Motherboard settings and hardware options vary. Refer to your OS documentation for detailed information.

### 1.10.2 Support DVD information

The Support DVD that comes with the motherboard package contains the drivers, software applications, and utilities that you can install to avail all motherboard features.



The contents of the Support DVD are subject to change at any time without notice. Visit the ASUS website at [www.asus.com](http://www.asus.com) for updates.

#### To run the Support DVD

Place the Support DVD into the optical drive. If Autorun is enabled in your computer, the DVD automatically displays the Specials screen which lists the unique features of your ASUS motherboard. Click Drivers, Utilities, AHCI/RAID Driver, Manual, Contact, and Specials tabs to display their respective menus.



The following screen is for reference only.

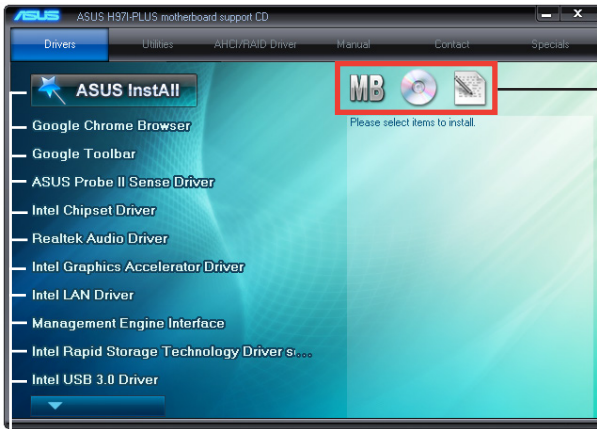

Click an icon to display Support DVD/motherboard information

Click an item to install



If Autorun is NOT enabled in your computer, browse the contents of the Support DVD to locate the file ASSETUP.EXE from the BIN folder. Double-click the ASSETUP.EXE to run the DVD.



# BIOS information

# 2

## 2.1 Managing and updating your BIOS



Save a copy of the original motherboard BIOS file to a USB flash disk in case you need to restore the BIOS in the future. Copy the original motherboard BIOS using the ASUS Update utility.

### 2.1.1 EZ Update

EZ Update is a utility that allows you to automatically update your motherboard's softwares, drivers and the BIOS version easily. With this utility, you can also manually update the saved BIOS and select a boot logo when the system goes into POST.

To launch EZ Update, click **EZ Update** on the AI Suite 3 main menu bar.

The screenshot shows the ASUS EZ Update utility window. On the left, a text box says "Click to automatically update your motherboard's driver, software and firmware" with a red arrow pointing to the "Check Now" button. Below the main window, three text boxes with red arrows point to specific UI elements: "Click to find and select the BIOS from file" points to the "..." button; "Click to select a boot logo" points to the "No Logo" button; and "Click to update the BIOS" points to the "Update" button. The main window displays BIOS information on the right and instructions on the left.

Click to automatically update your motherboard's driver, software and firmware

Click to find and select the BIOS from file

Click to select a boot logo

Click to update the BIOS



EZ Update requires an Internet connection either through a network or an ISP (Internet Service Provider).

## 2.1.2 ASUS EZ Flash 2

The ASUS EZ Flash 2 feature allows you to update the BIOS without using an OS-based utility.



Before you start using this utility, download the latest BIOS file from the ASUS website at [www.asus.com](http://www.asus.com).

### To update the BIOS using EZ Flash 2:

1. Insert the USB flash disk that contains the latest BIOS file to the USB port.
2. Enter the **Advanced Mode** of the BIOS setup program. Go to the **Tool** menu to select **ASUS EZ Flash 2 Utility** and press <Enter> to enable it.
3. Press the Left/Right arrow keys to switch to the **Drive** field.
4. Press the Up/Down arrow keys to find the USB flash disk that contains the latest BIOS, and then press <Enter>.
5. Press the Left/Right arrow keys to switch to the **Folder Info** field.
6. Press the Up/Down arrow keys to find the BIOS file, and then press <Enter> to perform the BIOS update process. Reboot the system when the update process is done.



- This function supports USB flash disks formatted using FAT32/16 on a single partition only.
- DO NOT shut down or reset the system while updating the BIOS to prevent system boot failure!

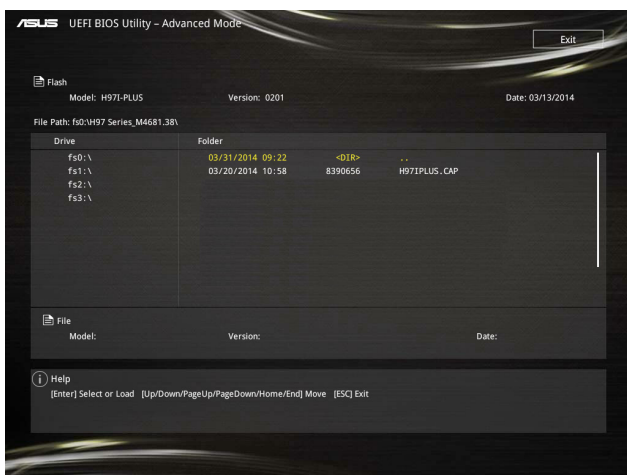

## 2.1.3 ASUS CrashFree BIOS 3 utility

The ASUS CrashFree BIOS 3 is an auto recovery tool that allows you to restore the BIOS file when it fails or gets corrupted during the updating process. You can restore a corrupted BIOS file using the motherboard support DVD or a USB flash drive that contains the updated BIOS file.



- 
- Before using this utility, rename the BIOS file in the removable device into **H97IPLUS.CAP**.
  - The BIOS file in the support DVD may not be the latest version. Download the latest BIOS file from the ASUS website at [www.asus.com](http://www.asus.com).
- 

### Recovering the BIOS

#### To recover the BIOS:

1. Turn on the system.
2. Insert the support DVD to the optical drive or the USB flash drive that contains the BIOS file to the USB port.
3. The utility automatically checks the devices for the BIOS file. When found, the utility reads the BIOS file and enters ASUS EZ Flash 2 utility automatically.
4. The system requires you to enter BIOS Setup to recover BIOS settings. To ensure system compatibility and stability, we recommend that you press <F5> to load default BIOS values.



---

DO NOT shut down or reset the system while updating the BIOS! Doing so can cause system boot failure!

---

## 2.1.4 ASUS BIOS Updater

ASUS BIOS Updater allows you to update the BIOS in DOS environment.



---

The screen captures used in this section are for reference only and may not be exactly the same as actually shown on your computer screen.

---

### Before updating BIOS

- Prepare the motherboard support DVD and a USB flash drive.
- Download the latest BIOS file and BIOS Updater from <http://support.asus.com> and save them in your USB flash drive.



---

NTFS is not supported under FreeDOS environment. Ensure that your USB flash drive is in single partition and in FAT32/16 format.

---

- Turn off the computer.
- Ensure that your computer has a DVD optical drive.

## Booting the system in DOS environment

To boot the system in DOS:

1. Insert the USB flash drive with the latest BIOS file and BIOS Updater to the USB port.
2. Boot your computer then press <F8> to launch the select boot device screen.
3. When the select boot device screen appears, insert the Support DVD into the optical drive then select the optical drive as the boot device.

```
Please select boot device:
↑ and ↓ to move selection
ENTER to select boot device
ESC to boot using defaults
-----
P2: ST3808110AS (76319MB)
aigo miniking (250MB)
UEFI: (FAT) ASUS DRW-2014L1T(4458MB)
P1: ASUS DRW-2014L1T(4458MB)
UEFI: (FAT) aigo miniking (250MB)
Enter Setup
```

4. When the booting message appears, press <Enter> within five (5) seconds to enter FreedOS prompt.

```
ISOLINUX 3.20 2006-08-26 Copyright (C) 1994-2005 H. Peter Anvin
A Bootable DVD/CD is detected. Press ENTER to boot from the DVD/CD.
If no key is pressed within 5 seconds, the system will boot next priority
device automatically. boot:
```

5. On the FreedOS prompt, type **d:** then press <Enter> to switch the disk from Drive C (optical drive) to Drive D (USB flash drive).

```
Welcome to FreeDOS (http://www.freedos.org) !
C: /> d:
D: />
```

## Updating the BIOS file

To update the BIOS file:

1. On the FreedOS prompt, type **bupdater /pc /g** and press <Enter>.

```
D: /> bupdater /pc /g
```

2. On the BIOS Updater screen, press <Tab> to switch from Files panel to Drives panel then select **D:**.

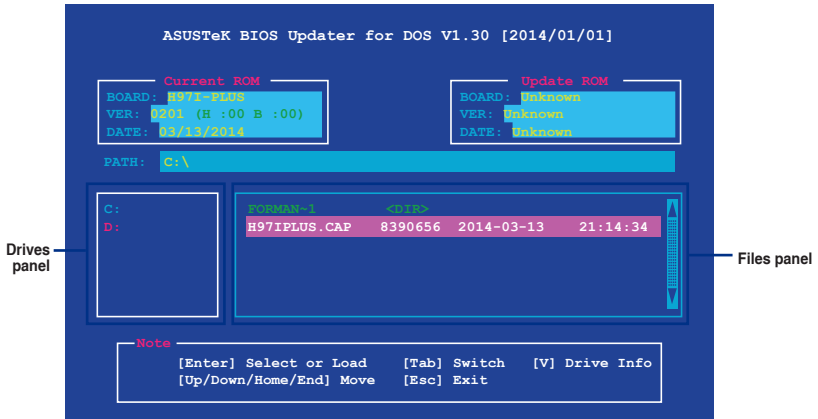

3. Press <Tab> to switch from Drives panel to Files panel then press <Up/Down or Home/End> keys to select the BIOS file and press <Enter>.
4. After the BIOS Updater checks the selected BIOS file, select **Yes** to confirm the BIOS update.



---

The BIOS Backup feature is not supported due to security regulations.

---

5. Select **Yes** then press <Enter>. When BIOS update is done, press <ESC> to exit BIOS Updater.
6. Restart your computer.



---

DO NOT shut down or reset the system while updating the BIOS to prevent system boot failure.

---



---

Ensure to load the BIOS default settings to ensure system compatibility and stability. Select the **Load Optimized Defaults** item under the **Exit BIOS menu**. See section 2.10 **Exit Menu** for details.

---

## 2.2 BIOS setup program

Use the BIOS Setup program to update the BIOS or configure its parameters. The BIOS screens include navigation keys and brief online help to guide you in using the BIOS Setup program.

### Entering BIOS Setup at startup

#### To enter BIOS Setup at startup:

Press <Delete> or <F2> during the Power-On Self Test (POST). If you do not press <Delete>, POST continues with its routines.

### Entering BIOS Setup after POST

#### To enter BIOS Setup after POST:

Press <Ctrl>+<Alt>+<Del> simultaneously.

Press the reset button on the system chassis.

Press the power button to turn the system off then back on. Do this option only if you failed to enter BIOS Setup using the first two options.



---

Using the power button, reset button, or the <Ctrl>+<Alt>+<Del> keys to force reset from a running operating system can cause damage to your data or system. We recommend you always shut down the system properly from the operating system.

---



- The BIOS setup screens shown in this section are for reference purposes only, and may not exactly match what you see on your screen.
  - Visit the ASUS website at [www.asus.com](http://www.asus.com) to download the latest BIOS file for this motherboard.
  - Ensure that a USB mouse is connected to your motherboard if you want to use the mouse to control the BIOS setup program.
  - If the system becomes unstable after changing any BIOS setting, load the default settings to ensure system compatibility and stability. Select the **Load Optimized Defaults** item under the Exit menu or press hotkey F5. See section 2.10 **Exit Menu** for details.
  - If the system fails to boot after changing any BIOS setting, try to clear the CMOS and reset the motherboard to the default value. See section 1.6 **Headers** for information on how to erase the RTC RAM.
- 

### BIOS menu screen

The BIOS setup program can be used under two modes: **EZ Mode** and **Advanced Mode**. Press <F7> to change between the two modes.

## 2.2.1 EZ Mode

By default, the EZ Mode screen appears when you enter the BIOS setup program. The EZ Mode provides you an overview of the basic system information, and allows you to select the display language, system performance mode, fan profile and boot device priority. To access the Advanced Mode, click **Advanced Mode(F7)** or press <F7>.



The default screen for entering the BIOS setup program can be changed. Refer to the **Setup Mode** item in section 2.8 **Boot menu** for details.

Displays the CPU/motherboard temperature, CPU voltage output, CPU/chassis fan speed, and SATA information

Selects the display language of the BIOS setup program

Displays the system performance properties of the selected mode. Click < or > to switch EZ System Tuning modes

Creates storage RAID and configures system overclocking

Enables or disables the Intel Rapid Storage Technology

Displays the CPU Fan's speed. Click the button to manually tune the fans

Loads optimized default settings

Shows the bootable devices

Saves the changes and resets the system

Displays the Advanced mode menus

Selects the boot device priority



The boot device options vary depending on the devices you installed to the system.

## 2.2.2 Advanced Mode

The Advanced Mode provides advanced options for experienced end-users to configure the BIOS settings. The figure below shows an example of the **Advanced Mode**. Refer to the following sections for the detailed configurations.



To access the EZ Mode, click **EzMode(F7)** or press <F7>.

The screenshot shows the ASUS UEFI BIOS Utility in Advanced Mode. The interface includes a menu bar at the top with options like My Favorites, Main, AI Tweaker, Advanced, Monitor, Boot, Tool, and Exit. A sub-menu item 'CPU Power Management Configuration' is expanded, showing various settings like Intel Adaptive Thermal Monitor, Hyper-threading, and CPU Power Management Configuration. A Hardware Monitor panel on the right displays CPU and memory statistics. The bottom of the screen shows the version number and a button to return to EZ Mode (F7).

Labels in the image point to the following components:

- Menu bar
- Language
- MyFavorite
- Q-Fan control
- EZ Tuning Wizard
- Quick Note
- Hot Keys
- Sub-menu item
- General help
- Configuration fields
- Scroll bar
- Last modified settings
- Goes back to EZ Mode
- Displays the CPU/motherboard temperature, CPU and memory voltage output



## Menu bar

The menu bar on top of the screen has the following main items:

<b>My Favorites</b>	For saving the frequently-used system settings and configuration
<b>Main</b>	For changing the basic system configuration
<b>Ai Tweaker</b>	For changing the overclocking settings
<b>Advanced</b>	For changing the advanced system settings
<b>Monitor</b>	For displaying the system temperature, power status, and changing the fan settings
<b>Boot</b>	For changing the system boot configuration
<b>Tool</b>	For configuring options for special functions
<b>Exit</b>	For selecting the exit options and loading default settings

## Menu items

The highlighted item on the menu bar displays the specific items for that menu. For example, selecting **Main** shows the Main menu items.

The other items (My Favorites, Ai Tweaker, Advanced, Monitor, Boot, Tool, and Exit) on the menu bar have their respective menu items.

## Submenu items

A greater than sign (>) before each item on any menu screen means that the item has a submenu. To display the submenu, select the item and press <Enter>.

## Language

This button above the menu bar contains the languages that you can select for your BIOS. Click this button to select the the language that you want to display in your BIOS screen.

## MyFavorites (F3)

This button above the menu bar shows all BIOS items in a Tree Map setup. Select frequently-used BIOS settings and save it to MyFavorites menu.



---

Refer to section **2.3 My Favorites** for more information.

---

## Q-Fan Control (F6)

This button above the menu bar displays the current settings of your fans. Use this button to manually tweak the fans to your desired settings.



---

Refer to section **2.2.3 QFan Control** for more information.

---

## EZ Tuning Wizard (F11)

This button above the menu bar allows you to view and tweak the overclocking settings of your system. It also allows you to change the motherboard's SATA mode from AHCI to RAID mode.



---

Refer to section **2.2.4 EZ Tuning Wizard** for more information.

---

## Quick Note (F9)

This button above the menu bar allows you to key in notes of the activities that you have done in BIOS.



- 
- The Quick Note function does not support the following keyboard functions: delete, cut, copy and paste.
  - You can only use the alphanumeric characters to enter your notes.
- 

## Hot keys

This button above the menu bar contains the navigation keys for the BIOS setup program. Use the navigation keys to select items in the menu and change the settings.

## Scroll bar

A scroll bar appears on the right side of a menu screen when there are items that do not fit on the screen. Press the Up/Down arrow keys or <Page Up> / <Page Down> keys to display the other items on the screen.

## General help

At the bottom left of the menu screen is a brief description of the selected item. Use <F12> key to capture the BIOS screen and save it to the removable storage device.

## Configuration fields

These fields show the values for the menu items. If an item is user-configurable, you can change the value of the field opposite the item. You cannot select an item that is not user-configurable.

A configurable field is highlighted when selected. To change the value of a field, select it and press <Enter> to display a list of options.

## Last Modified button

This button shows the items that you last modified and saved in BIOS Setup.

## 2.2.3 QFan Control

The QFan Control allows you to set a fan profile or manually configure the operating speed of your CPU and chassis fans.

The screenshot shows the ASUS Q-Fan Tuning utility in the BIOS. It features a graph of fan speed (%) vs. temperature (°C) and a profile selection slider. Annotations with red lines point to various UI elements:

- Click to select a fan to be configured**: Points to the fan selection menu on the left containing CPU FAN, CHA1 FAN, and CHA2 FAN.
- Click to activate PWM Mode**: Points to the 'PWM' button above the graph.
- Click to activate DC Mode**: Points to the 'DC' button above the graph.
- Select a profile to apply to your fans**: Points to the 'Standard' profile on the slider.
- Click to undo the changes**: Points to the 'Undo' button.
- Click to apply the fan setting**: Points to the 'Apply' button.
- Click to go back to main menu**: Points to the 'Exit (ESC)' button.

The graph shows a yellow line representing the fan speed profile, which is currently set to 'Standard'. The slider below the graph has five positions: Standard, Silent, Turbo, Full Speed, and Manual. The 'Standard' position is selected.

Temperature (°C)	Fan Speed (%)
0	25
30	25
40	40
50	60
60	75
70	100
100	100

## Configuring fans manually

Select **Manual** from the list of profiles to manually configure your fans' operating speed.

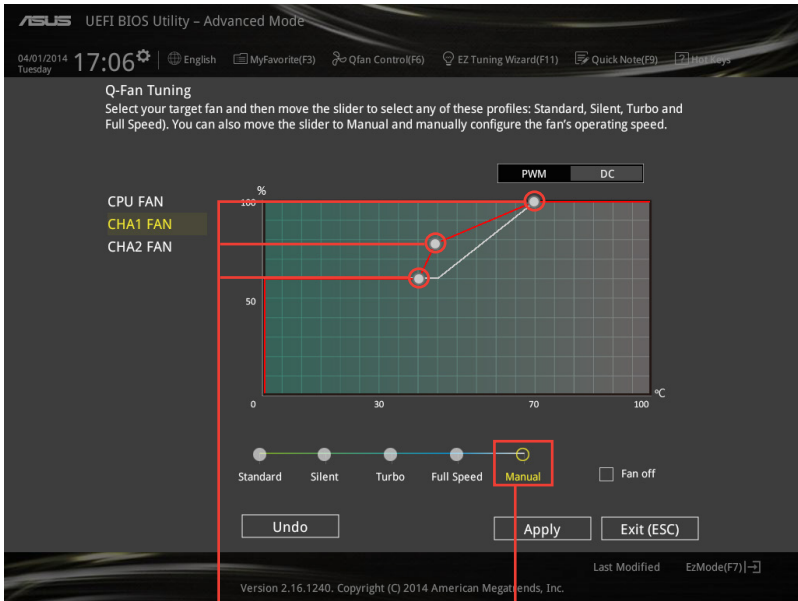

Speed points

Click to manually  
configure your fans

To configure your fans:

1. Select the fan that you want to configure and to view its current status.
2. Click and drag the speed points to adjust the fans' operating speed.
3. Click **Apply** to save the changes then click **Exit (ESC)**.

## 2.2.4 EZ Tuning Wizard

EZ Tuning Wizard allows you to overclock your CPU and DRAM, computer usage, and CPU fan to their best settings. You can also easily set RAID in your system using this feature.

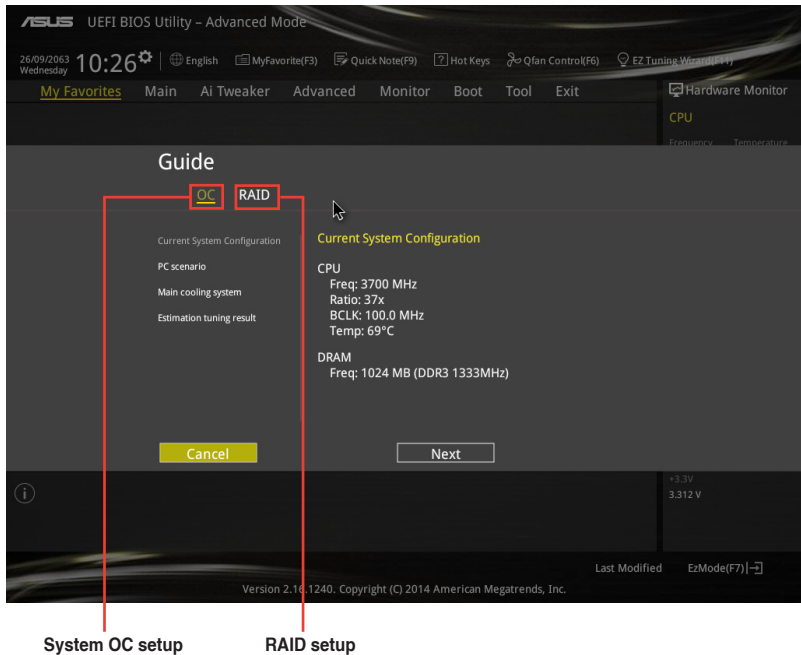

### Tuning your system settings

To tune your settings:

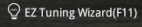
1. Press <F11> on your keyboard or click  from the BIOS screen to open EZ Tuning Wizard screen, then click **Next**.
2. Select a PC scenario **Daily Computing** or **Gaming/Media Editing**, then click **Next**.
3. Select the CPU fan type (**Box cooler**, **Tower cooler**, or **Water cooler**) that you installed then click **Next**.



If you are not sure of the CPU fan type, click **I'm not sure**. The system automatically detects the CPU fan type.

4. Click **Next** then click **Yes** to confirm auto-tuning.

## Creating RAID

To create RAID:

1. Press <F11> on your keyboard or click **EZ Tuning Wizard(F11)** from the BIOS screen to open EZ Tuning Wizard screen.
2. Click **RAID** then click **Next**.



- Ensure that your HDDs have no existing RAID volumes.
- Ensure to connect your HDDs to Intel® SATA connectors.

3. Select the type of storage for your RAID **Easy Backup** or **Super Speed**, then click **Next**.

- a. For Easy Backup, click **Next** then select from **Easy Backup (RAID1)** or **Easy Backup (RAID10)**.



You can only select Easy Backup (RAID 10) if you connect four (4) HDDs.

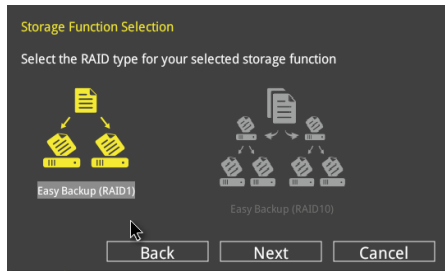

- b. For Easy Backup, click **Next** then select from **Super Speed (RAID0)** or **Super Speed (RAID5)**.

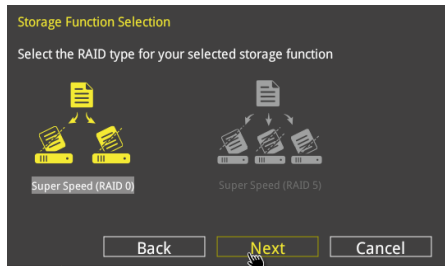

4. After selecting the type of RAID, click **Next** then click **Yes** to continue the RAID setup.
5. After the RAID setup is done, click **Yes** to exit the setup then click **OK** to reset your system.

## 2.3 My Favorites

MyFavorites is your personal space where you can easily save and access your favorite BIOS items.

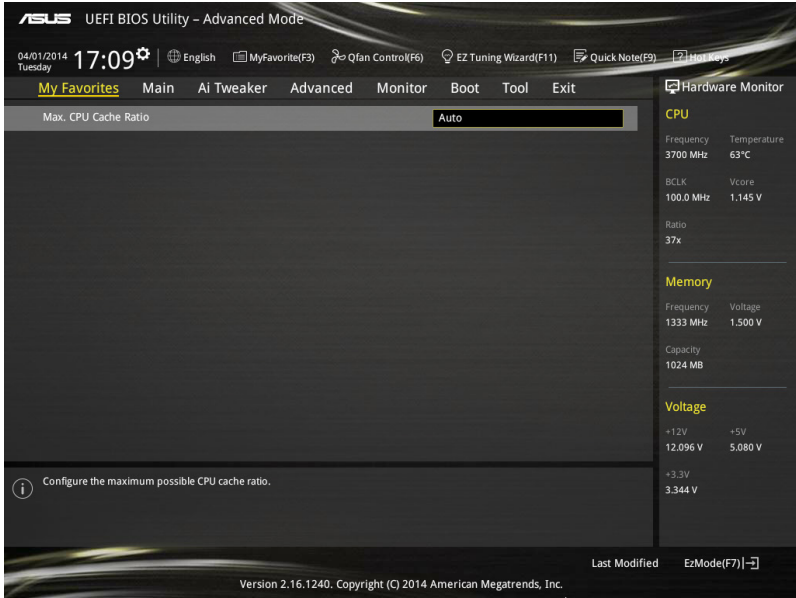

## Adding items to My Favorites

To add BIOS items:

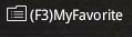
1. Press <F3> on your keyboard or click  from the BIOS screen to open Setup Tree Map screen.
2. On the Setup Tree Map screen, select the BIOS items that you want to save in MyFavorites screen.

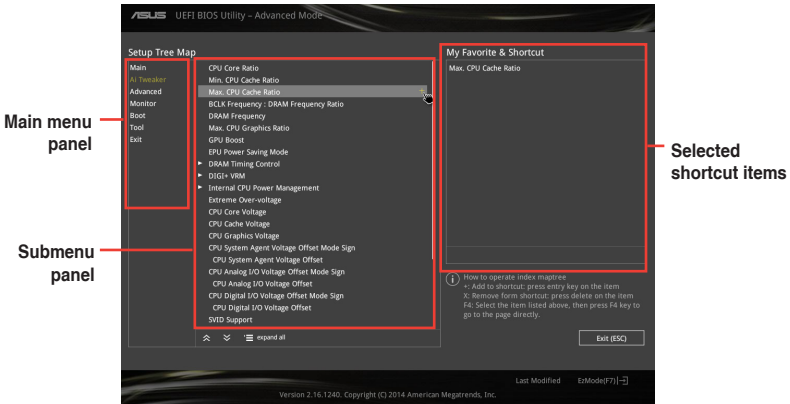

3. Select an item from main menu panel, then click the submenu that you want to save as favorite from the submenu panel and click .



You cannot add the following items to My Favorite items:

- Items with submenu options
- User-managed items such as language and boot order
- Configuration items such as Memory SPD Information, system time and date.

4. Click **Exit (ESC)** or press <esc> key to close Setup Tree Map screen.
5. Go to My Favorites menu to view the saved BIOS items.



## 2.4 Main menu

The Main menu screen appears when you enter the Advanced Mode of the BIOS Setup program. The Main menu provides you an overview of the basic system information, and allows you to set the system date, time, language, and security settings.



### 2.4.1 Language [English]

Allows you to choose the BIOS language version from the options. Configuration options: [English] [Français] [Deutsch] [简体中文] [繁體中文] [日本語] [Español] [Русский] [한국어]

### 2.4.2 Security

The Security menu items allow you to change the system security settings.



- If you have forgotten your BIOS password, erase the CMOS Real Time Clock (RTC) RAM to clear the BIOS password. See section 1.6 Headers for information on how to erase the RTC RAM.
- The **Administrator** or **User Password** items on top of the screen show the default **Not Installed**. After you set a password, these items show **Installed**.

### Administrator Password

If you have set an administrator password, we recommend that you enter the administrator password for accessing the system. Otherwise, you might be able to see or change only selected fields in the BIOS setup program.

**To set an administrator password:**

1. Select the **Administrator Password** item and press <Enter>.
2. From the **Create New Password** box, key in a password, then press <Enter>.
3. Confirm the password when prompted.

**To change an administrator password:**

1. Select the **Administrator Password** item and press <Enter>.
2. From the **Enter Current Password** box, key in the current password, then press <Enter>.
3. From the **Create New Password** box, key in a new password, then press <Enter>.
4. Confirm the password when prompted.

To clear the administrator password, follow the same steps as in changing an administrator password, but press <Enter> when prompted to create/confirm the password. After you clear the password, the **Administrator Password** item on top of the screen shows **Not Installed**.

**User Password**

If you have set a user password, you must enter the user password for accessing the system. The **User Password** item on top of the screen shows the default **Not Installed**. After you set a password, this item shows **Installed**.

**To set a user password:**

1. Select the **User Password** item and press <Enter>.
2. From the **Create New Password** box, key in a password, then press <Enter>.
3. Confirm the password when prompted.

**To change a user password:**

1. Select the **User Password** item and press <Enter>.
2. From the **Enter Current Password** box, key in the current password, then press <Enter>.
3. From the **Create New Password** box, key in a new password, then press <Enter>.
4. Confirm the password when prompted.

To clear the user password, follow the same steps as in changing a user password, but press <Enter> when prompted to create/confirm the password. After you clear the password, the **User Password** item on top of the screen shows **Not Installed**.

## 2.5 Ai Tweaker menu

The Ai Tweaker menu items allow you to configure overclocking-related items.



Be cautious when changing the settings of the Ai Tweaker menu items. Incorrect field values can cause the system to malfunction.



The configuration options for this section vary depending on the CPU and DIMM model you installed on the motherboard.

Scroll down to display other BIOS items.

The screenshot shows the ASUS UEFI BIOS Utility in Advanced Mode. The 'Ai Tweaker' menu is selected, displaying various overclocking settings. The 'CPU Core Ratio' is set to 'Auto'. Other settings include Target CPU Frequency (3700MHz), Target DRAM Frequency (1333MHz), Target Cache Frequency (3700MHz), Target DMI/PEG Frequency (100MHz), and Target CPU Graphics Frequency (1150MHz). The Hardware Monitor on the right shows CPU Frequency at 3700 MHz and Temperature at 63°C. The BIOS version is 2.16.1240, Copyright (C) 2014 American Megatrends, Inc.

### 2.5.1 CPU Core Ratio [Auto]

Allows you to set the CPU core ratio automatically or manually.

[Auto] Sets all CPU Core Ratio to Intel® CPU default settings automatically.

[Sync All Cores] Allows you to set CPU Core Ratio settings for all cores.

[Per Core] Allows you to set CPU Core Ratio individually.



---

The following two items appear only when you set the **CPU Core Ratio** to **[Sync All Cores]** or **[Per Core]**.

---

### 1-Core Ratio Limit [Auto]

Select [Auto] to apply the CPU default Turbo Ratio setting or manually assign a 1-Core Limit value, which should be higher than or equal to the 2-Core Ratio Limit.

### 2-Core Ratio Limit [Auto]

Select [Auto] to apply the CPU default Turbo Ratio setting or manually assign a 2-Core Ratio Limit value. 1-Core Ratio Limit must not be set to [Auto].

## 2.5.2 Min. CPU Cache Ratio [Auto]

This item allows you to set the minimum possible ratio on the Uncore part of the processor. Use the <+> or <-> keys to adjust the value. The values depend on the CPU installed.

## 2.5.3 Max. CPU Cache Ratio [Auto]

This item allows you to set the maximum possible ratio on the Uncore part of the processor. Use the <+> or <-> keys to adjust the value. The values depend on the CPU installed.

## 2.5.4 BCLK Frequency: DRAM Frequency Ratio [Auto]

Allows you to set the CPU bus speed to DRAM speed ratio mode.

[Auto] DRAM speed is set to the optimized settings.

[100:133] The BCLK frequency to DRAM speed ratio is set to 100:133.

[100:100] The BCLK frequency to DRAM speed ratio is set to 100:100.

## 2.5.5 DRAM Frequency [Auto]

This item allows you to set the memory operating frequency. The configurable options vary with the BCLK (base clock) frequency setting. Select the auto mode to apply the optimized setting. Configuration options: [DDR3-800MHz] [DDR3-1066MHz] [DDR3-1333MHz] [DDR3-1600MHz] [DDR3-1800MHz] [DDR3-1866MHz] [DDR3-2000MHz] [DDR3-2133MHz] [DDR3-2200MHz] [DDR3-2400MHz] [DDR3-2600MHz] [DDR3-2666MHz] [DDR3-2800MHz] [DDR3-2933MHz] [DDR3-3000MHz] [DDR3-3200MHz] [DDR3-3400MHz]



---

Selecting a very high memory frequency may cause the system to become unstable! If this happens, revert to the default setting.

---

## 2.5.6 Max. CPU Graphics Ratio [Auto]

Allows you to set the CPU Graphics ratio. Use <+>/<-> to adjust the value. The ratio may vary depending on the system loading.

## 2.5.7 GPU Boost

GPU Boost accelerates the integrated GPU for extreme graphics performance. Configuration options: [Keep Current Settings] [Enabled]

## 2.5.8 EPU Power Saving Mode [Disabled]

ASUS EPU (Energy Processing Unit) sets the CPU in its minimum power consumption settings. Enable this item to set lower CPU VCCIN and Vcore voltages and achieve the best energy saving condition. Configuration options: [Disabled] [Enabled]

## 2.5.9 DRAM Timing Control

The subitems in this menu allow you to set the DRAM timing control features. Use the <+> and <-> keys to adjust the value. To restore the default setting, type [auto] using the keyboard and press the <Enter> key.



Changing the values in this menu may cause the system to become unstable! If this happens, revert to the default settings.

## 2.5.10 External DIGI+ Power Control

### CPU Load-Line Calibration [Auto]

Load-line is defined by Intel VRM specification and affects the CPU power voltage. The CPU working voltage will decrease proportionally depending on the CPU loading. Higher levels of the load-line calibration can get a higher voltage and a better overclocking performance but increases the CPU and VRM thermal. Configuration options: [Auto] [Level 1] [Level 2] ~[Level 8] [Level 9]



The boosted performance may vary depending on the CPU specification. Do not remove the thermal module.

### CPU VRM Switching Frequency [Auto]

This item affects the VRM transient response speed and the component thermal production. Select [Manual] to configure a higher frequency for a quicker transient response speed. Configuration options: [Auto] [Manual]



DO NOT remove the thermal module. The thermal conditions should be monitored.



The following item appears only when you set the CPU VRM Switching Frequency to [Manual].

### Fixed CPU VRM Switching Frequency (KHz) [300]

This item allows you to set a higher frequency for a quicker transient response speed. Use the <+> and <-> keys to adjust the value. The values range from 300KHz to 500KHz with a 50KHz interval.

### CPU Power Phase Control [Auto]

This item allows you to set the power phase control of the CPU. Configuration options: [Auto] [Standard] [Optimized] [Extreme] [Power Phase Response]



DO NOT remove the thermal module when setting this item to [Power Phase Response]. The thermal conditions should be monitored.



---

The following item appears only when you set the CPU Power Phase Control to **[Power Phase Response]**.

---

### **Power Phase Response [Fast]**

This item allows you to set a faster phase response for the CPU to increase system performance or to slower phase response to decrease DRAM power efficiency.

Configuration options: [Ultra Fast] [Fast] [Medium] [Regular]

### **CPU Power Duty Control [T.Probe]**

DIGI + VRM Duty control adjusts the current and thermal conditions of every component's phase.

[T. Probe] Select to maintain the VRM thermal balance.

[Extreme] Select to maintain the current VRM balance.

### **CPU Current Capability [Auto]**

Allows you to configure the total power range, and extends the overclocking frequency range simultaneously. Configuration options: [Auto] [100%] [110%] [120%] [130%] [140%]



---

Choose a higher value when overclocking, or under a high CPU loading for extra power support.

---

### **CPU Power Thermal Control [120]**

A higher temperature brings a wider CPU power thermal range and extends the overclocking tolerance to enlarge the overclocking potential. Use the <+> or <-> keys to adjust the value.

The values depend on the CPU installed.



---

DO NOT remove the thermal module. The thermal conditions should be monitored.

---

### **DRAM Current Capability [100%]**

This item adjusts the total power range for DRAM overclocking. Set a higher value to provide a wider total power range and extends the overclocking frequency range simultaneously.

Configuration options: [100%] [110%] [120%] [130%]

### **DRAM Switching Frequency [Auto]**

This item affects the overclocking range and system stability. Set this item to **[Manual]** to manually set a fixed DRAM switching frequency for an increased overclocking range or enhanced system stability.



---

The following item appears only when you set the DRAM Switching Frequency to **[Manual]**.

---

#### ***Fixed DRAM Switching Frequency (KHz) [300]***

This item allows you to set a higher frequency for an increased overclocking range or a lower frequency for an enhanced system stability. Use the <+> or <-> to adjust the value. The values range from 300 KHz to 500 KHz with an interval of 50 KHz.

## DRAM Power Phase Control [Auto]

Select [Extreme] for full phase mode to increase system performance or select [Optimized] for ASUS optimized phase tuning profile to increase DRAM power efficiency. Configuration options: [Auto] [Optimized] [Extreme]

## 2.5.11 Internal CPU Power Management

The subitems in this menu allow you to set the CPU ratio and their features.

### Enhanced Intel SpeedStep Technology [Enabled]

This item allows the operating system to dynamically adjust the processor voltage and cores frequency, resulting to a decreased average power consumption and decreased average heat production. Configuration options: [Disabled] [Enabled]

### Turbo Mode [Enabled]

This item allows you to enable your core processor's speed to run faster than the base operating frequency when it is below operating power, current and temperature specification limit. Configuration options: [Disabled] [Enabled]



---

The following items appear only when you set the Turbo Mode to **[Enabled]**.

---

### Turbo Mode Parameters

#### Long Duration Package Power Limit [Auto]

Allows you to limit the Turbo Ratio's time duration that exceeds the TDP (Thermal Design Power) for maximum performance. Use the <+> or <-> keys to adjust the value. The values range from 1 W to 4096 W.

#### Package Power Time Window [Auto]

Also known as Power Limit 1, this item allows you to maintain the time window for Turbo Ratio over TDP (Thermal Design Power). Use the <+> or <-> keys to adjust the value. The values range from 1 to 127 in seconds.

#### Short Duration Package Power Limit [Auto]

Also known as Power Limit 2, this item allows you to provide rapid protection when the package power exceeds the Power Limit 1. Use the <+> or <-> keys to adjust the value. The values range from 1 W to 4096 W.

#### CPU Integrated VR Current Limit [Auto]

Allows you to set a higher current limit to prevent frequency and power throttling when overclocking. Use the <+> or <-> keys to adjust the value. The values range from 0.125 to 1023.875 with a 0.125 interval.

### CPU Internal Power Switching Frequency

#### Frequency Tuning Mode [Auto]

This item allows you to increase or decrease the switching frequency of the internal regulator. Decrease the switching frequency to reduce the power consumption or increase the switching frequency to enhance voltage stability. When this item is set to [+] or [-], the Frequency Tuning Offset appears that allows you to set its value from 0% to 6%.

## CPU Internal Power Fault Control

### Thermal Feedback [Auto]

Allows your system to take precautionary actions to protect the CPU when the thermal condition of the external regulator exceeds the threshold. Configuration options: [Auto] [Disabled] [Enabled]

### CPU Integrated VR Fault Management [Auto]

Disable this item to prevent tripping the Fully Integrated Voltage Regulator when doing over-voltage. We recommend you to disable this item when overclocking. Configuration options: [Auto] [Disabled] [Enabled]

## CPU Internal Power Configuration

### CPU Integrated VR Efficiency Management [Auto]

This item allows you to improve the power rating when the CPU is in low power state, or make the FIVR (fully integrated voltage regulator work in high performance at all times. Configuration options: [Auto] [High Performance] [Balanced]

### Power Decay Mode [Auto]

This item allows your system to improve the power saving mode on the Fully Integrated Voltage Regulator as the processor goes into low current state. Configuration options: [Auto] [Disabled] [Enabled]

### Idle Power-in Response [Auto]

This item allows you to set the slew rate for the Fully Integrated Voltage Regulator when it enters manual override mode. Configuration options: [Auto] [Regular] [Fast]

### Idle Power-out Response [Auto]

This item allows you to set the slew rate for the Fully Integrated Voltage Regulator when it exits manual override mode. Configuration options: [Auto] [Regular] [Fast]

### Power Current Slope [Auto]

This item allows you to enhance the power saving condition or the system overclocking capability. Select a higher power current slope levels for power saving enhancement or lower power current slope levels for system overclocking enhancement. Configuration options: [Auto] [LEVEL -4] - [LEVEL 4]

### Power Current Offset [Auto]

This item allows you to increase or decrease the output current sensed by the CPU. It finds the balance between optimal regulating while staying below the current threshold. Configuration options: [Auto] [100%] [87.5%] [75.0%] [62.5%] [50.0%] [37.5%] [25.0%] [12.5%] [0%] [-12.5%] [-25.0%] [-37.5%] [-50.0%] [-62.5%] [-75.0%] [-87.5%] [-100%]

### Power Fast Ramp Response [Auto]

This item allows you to enhance the response of the CPU voltage regulator during the load transients. Use the <+> or <-> to adjust the value. The values range from 0.00 to 1.50. Configuration options: [Auto] [0.00] - [1.50]



## CPU Internal Power Saving Control

### Power Saving Level 1 Threshold [Auto]

Lower value provides sufficient overclocking tolerance to enlarge the overclocking potential. Higher value provides better power-saving condition. Use <+> or <-> key to adjust the value. The values range from 0 A to 80 A at 1 A increment.

### Power Saving Level 2 Threshold [Auto]

Lower value provides sufficient overclocking tolerance to enlarge the overclocking potential. Higher value provides better power-saving condition. Use <+> or <-> key to adjust the value. The values range from 0 A to 50 A at 1 A increment.

### Power Saving Level 3 Threshold [Auto]

Lower value provides sufficient overclocking tolerance to enlarge the overclocking potential. Higher value provides better power-saving condition. Use <+> or <-> key to adjust the value. The values range from 0 A to 30 A at 1 A increment.

## 2.5.12 Extreme Over-voltage [Disabled]

This item allows you to set higher voltages for overclocking. When you enable this item, you can choose a high level voltage to overclock, but does not guarantee the CPU life. Configuration options: [Disabled] [Enabled]

## 2.5.13 CPU Core Voltage [Auto]

This item allows you to configure the amount of voltage fed to the CPU cores. Increase the voltage when setting a high Core Frequency value. Configuration options: [Auto] [Manual Mode] [Offset Mode]



---

The following item appears only when you set the CPU Core Voltage to **[Manual Mode]**.

---

### CPU Core Voltage Override [Auto]

Allows you to set the CPU Core Voltage override. Use the <+> or <-> keys to adjust the value. The values range from 0.001V to 1.920V with a 0.001V interval.



---

The following items appear only when you set the CPU Core Voltage to **[Offset Mode]**.

---

### Offset Mode Sign [+]

[+] To offset the voltage by a positive value.

[-] To offset the voltage by a negative value.

### CPU Core Voltage Offset

Use the <+> or <-> keys to adjust the value. The values range from 0.001V to 0.999V with a 0.001V interval.

## 2.5.14 CPU Cache Voltage [Auto]

This item allows you to set the amount of voltage fed to the CPU uncores including its cache. Increase the voltage when setting a high CPU cache frequency. Configuration options: [Auto] [Manual Mode] [Offset Mode].



---

The following item appears only when you set the CPU Cache Voltage to **[Manual Mode]**.

---

### **CPU Cache Voltage Override [Auto]**

This item allows you to set the CPU Cache Voltage override. By default, this item takes the standard value of the installed CPU. You can use the <+> or <-> keys to adjust the value. The values range from 0.001V to 1.920V with a 0.001V interval.



---

The following items appear only when you set the CPU Cache Voltage to **[Offset Mode]**.

---

### **Offset Mode Sign [+]**

- [+] To offset the voltage by a positive value.
- [-] To offset the voltage by a negative value.

### **CPU Cache Voltage Offset**

Allows you to set the CPU cache voltage offset. By default, this item takes the standard value of the installed CPU. You can use the <+> or <-> keys to adjust the value. The values range from 0.001V to 0.999V with a 0.001V interval.

## **2.5.15 CPU Graphics Voltage [Auto]**

This item allows you to set the CPU graphics voltage. Increase the graphics voltage when increasing the iGPU frequency. Configuration options: **[Auto]** **[Manual Mode]** **[Offset Mode]** **[Adaptive Mode]**.



- The following item appears only when you set the CPU Graphics Voltage to **[Manual Mode]**.
  - **[Adaptive Mode]** is available for some specific CPU types.
- 

### **CPU Graphics Voltage Override [Auto]**

This item allows you to set the CPU graphics voltage override. The values range from 0.001V to 1.920V with a 0.001V interval.



---

The following items appear only when you set the CPU Graphics Voltage to **[Offset Mode]** or **[Adaptive Mode]**.

---

### **Offset Mode Sign [+]**

- [+] To offset the voltage by a positive value.
- [-] To offset the voltage by a negative value.

### **CPU Graphics Voltage Offset [Auto]**

This item appears only when you set the CPU Graphics Voltage to **[Offset Mode]** or **[Adaptive Mode]** and allows you to set the CPU graphics voltage offset. The values range from 0.001V to 0.999V with a 0.001V interval.



---

The following items appear only when you set the CPU Graphics Voltage to [Adaptive Mode].

---

### **Additional Turbo Mode CPU Graphics Voltage [Auto]**

This item appears only when you set the CPU Graphics Voltage to [Adaptive Mode] and allows you to set the additional turbo mode CPU graphics voltage. The values range from 0.001V to 1.920V with a 0.001V interval.

### **Total Adaptive Mode CPU Graphics Voltage [Auto]**

This item sums up the voltages of the CPU Graphics Voltage offset and Additional Turbo Mode CPU Graphics Voltage options.

## **2.5.16 CPU System Agent Voltage Offset Mode Sign [+]**

- [+] To offset the voltage by a positive value.
- [-] To offset the voltage by a negative value.

### **CPU System Agent Voltage Offset [Auto]**

This item allows you to set the amount of voltage fed to the system agent of the CPU including its PCIE controller and the PCU (power control unit). Increase the voltage to enhance the overclocking capability. You can use the <+> or <-> keys to adjust the value. The values range from 0.001V to 0.999V with a 0.001V interval.

## **2.5.17 CPU Analog I/O Voltage Offset Mode Sign [+]**

- [+] To offset the voltage by a positive value.
- [-] To offset the voltage by a negative value.

### **CPU Analog I/O Voltage Offset [Auto]**

This item allows you to set the amount of voltage fed to the analog portion of the I/O on the CPU. By default, this item takes the standard value of the installed CPU. Increase the amount of voltage to enhance the overclocking capability. You can use the <+> or <-> keys to adjust the value. The values range from 0.001V to 0.999V with a 0.001V interval.

## **2.5.18 CPU Digital I/O Voltage Offset Mode Sign [+]**

- [+] To offset the voltage by a positive value.
- [-] To offset the voltage by a negative value.

### **CPU Digital I/O Voltage Offset [Auto]**

This item allows you to set the amount of voltage fed to the digital portion of the I/O on the processor. By default, this item takes the standard value of the installed CPU. Increase the amount of voltage to enhance the overclocking capability. You can use the <+> or <-> keys to adjust the value. The values range from 0.001V to 0.999V with a 0.001V interval.

## **2.5.19 SVID Support [Auto]**

Set this item to [Enabled] when overclocking your system. Disabling this item stops the CPU from communicating with the external voltage regulator. Configuration options: [Auto] [Disabled] [Enabled]



---

The following item appears only when you set SVID Support to **[Enabled]**.

---

## **SVID Voltage Override [Auto]**

This item allows you to set the SVID Voltage override. By default, this item takes the standard value of the installed CPU. You can use the <+> or <-> keys to adjust the value. The values range from 0.001V to 2.440 V with a 0.001 V interval.

## **2.5.20 CPU Input Voltage(VCCIN) [Auto]**

Allows you to set the input voltage for the CPU by the external voltage regulator. You can use the <+> or <-> keys to adjust the value. The values range from 0.800V to 2.700V with a 0.010V interval.

## **2.5.21 DRAM Voltage [Auto]**

Allows you to set the DRAM Voltage. You can use the <+> or <-> keys to adjust the value. The values range from 1.20000V to 1.92000V with a 0.00500V interval.



---

According to Intel CPU specifications, DIMMs with voltage requirement over 1.65V may damage the CPU permanently. We recommend that you install the DIMMs with the voltage requirement below 1.65V.

---

## **2.5.22 PCH VLX Voltage [Auto]**

This item allows you to set the I/O voltage on the PCH (Platform Controller Hub). You can use the <+> or <-> keys to adjust the value. The values range from 1.1850V to 2.1350V with a 0.0050V interval.

## **2.5.23 PCH Core Voltage [Auto]**

This item allows you to set the core voltage on the PCH (Platform Controller Hub). You can use the <+> or <-> keys to adjust the value. The values range from 0.73500V to 1.50000V with a 0.00500V interval.



---

The system may need better cooling system for a more stable performance under high voltage settings.

---

## **2.5.24 DRAM CTRL REF Voltage [Auto]**

This item allows you to set the DRAM reference voltage on the control lines from the memory bus. You can use the <+> or <-> keys to adjust the value. The values range from 0.39500V to 0.63000V with a 0.00500V interval.

## **2.5.25 DRAM DATA REF Voltage on CHA/CHB [Auto]**

This item allows you to set the DRAM reference voltage on the data lines on Channels A and B. You can use the <+> or <-> keys to adjust the value. The values range from 0.39500V to 0.63000V with a 0.00500V interval.



---

To set a value for the DRAM reference voltage, we recommend you to set a value close to the standard value which is 0.500000x.

---

## 2.5.26 CPU Spread Spectrum [Auto]

This item allows you to enhance the BCLK overclocking capability or reduce the EMI (electromagnetic disturbance) generated by the BCLK. Set this item to [Enabled] for EMI reduction, or set this item to [Disabled] to enhance BCLK overclocking. Configuration options: [Auto] [Disabled] [Enabled]

## 2.6 Advanced menu

The Advanced menu items allow you to change the settings for the CPU and other system devices.



Be cautious when changing the settings of the Advanced menu items. Incorrect field values can cause the system to malfunction.

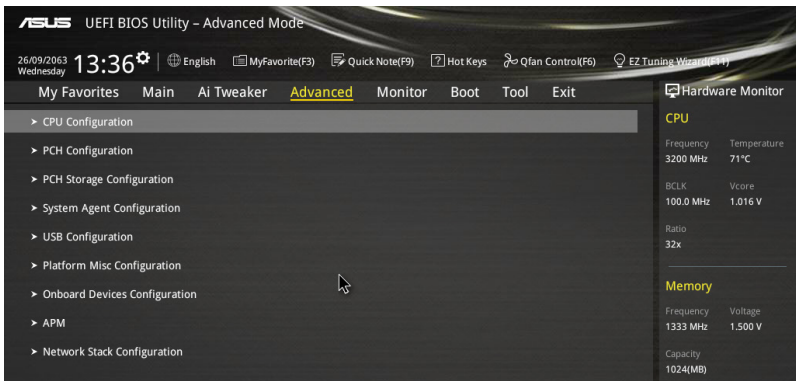

### 2.6.1 CPU Configuration

The items in this menu show the CPU-related information that the BIOS automatically detects.



The items shown in submenu may be different due to the CPU you installed.

#### Intel Adaptive Thermal Monitor [Enabled]

This item allows you to protect the CPU by decreasing its frequency as it reaches the thermal throttle point. The thermal monitor includes TM1 (Thermal monitor 1), TM2 (Thermal monitor 2), and EMTTM (Enhanced Multi-threaded Thermal Monitoring). Configuration options: [Disabled] [Enabled]

#### Hyper-threading [Enabled]

Allows a hyper-threading processor to appear as two logical processors, allowing the operating system to schedule two threads or processes simultaneously. Configuration options: [Disabled] [Enabled]

## Active Processor Cores [All]

This item allows you to select the number of CPU cores to activate in each processor package. Configuration options: [All] [1] [2] [3]



---

For some CPU types, only [All] and [1] appear.

---

## Limit CPUID Maximum [Disabled]

When set to [Enabled], this item allows the legacy OS to boot even without support for CPUs with extended CPUID functions. Configuration options: [Disabled] [Enabled]

## Execute Disable Bit [Enabled]

Execute Disable prevents certain classes of malicious buffer overflow attacks when combined with a supporting OS (SuSE Linux 9.2, RedHat Enterprise 3 Update 3). Configuration options: [Disabled] [Enabled]

## Intel Virtualization Technology [Disabled]

When set to [Enabled], a VMM can utilize the additional hardware capabilities provided by Vanderpool Technology. Configuration options: [Disabled] [Enabled]

## Hardware Prefetcher(L2 Cache) [Enabled]

This item allows the CPU to prefetch commands and data in the L2 cache, reduces the DRAM loading time and improves the system performance. Configuration options: [Disabled] [Enabled]

## Adjacent Cache Line Prefetcher [Enabled]

This item allows the mid level cache (L2) to prefetch adjacent cache lines, reducing the DRAM loading time and improves the system performance. Configuration options: [Disabled] [Enabled]

## Boot Performance Mode [Max on-Turbo Performance]

This item allows you to select the CPU performance state during system boot before the operating system takes control. The CPU runs at a selected performance ratio based on CPU configuration. Configuration options: [Max Non-Turbo Performance] [Max Battery] [Turbo Performance]

## CPU Power Management Configuration

This item allows you to manage and configure the CPU's power.

### Enhanced Intel SpeedStep Technology [Enabled]

This item allows your system to adjust the CPU's voltage and cores frequency, resulting in decreased power consumption and heat production.

[Disabled]      The CPU runs at its default speed.

[Enabled]      The system controls the CPU speed.

### Turbo Mode [Enabled]

This item allows you to automatically set the CPU cores to run faster than the base operating frequency when it is below the operating power, current and temperature specification limit. Configuration options: [Enabled] [Disabled]



---

Turbo Mode is only available on selected CPU models only.

---

### **CPU C-States [Auto]**

This item allows you to set the power saving of the CPU states. Configuration options: [Auto] [Disabled] [Enabled]



---

The following items appear only when you set the CPU C-States to **[Enabled]**.

---

#### ***Enhanced C1 state [Enabled]***

This item allows your CPU to reduce power consumption when the system is in idle mode. Configuration options: [Enabled] [Disabled]

#### ***CPU C3 Report [Enabled]***

This item allows you to disable or enable the CPU C3 report to the operating system. Configuration options: [Enabled] [Disabled]

#### ***CPU C6 Report [Enabled]***

This item allows you to disable or enable the CPU C6 report to the operating system. Configuration options: [Enabled] [Disabled]

#### ***C6 Latency [Short]***

This item allows you to set the duration of C6 latency for C6 state. Configuration options: [Short] [Long]

#### ***CPU C7 Report [CPU C7s]***

This item allows you to disable or enable the CPU C7 report to the operating system. Configuration options: [Disabled] [CPU C7] [CPU C7s]

#### ***C7 Latency [Long]***

This item allows you to set the duration of C7 latency for C7 state. Configuration options: [Short] [Long]

#### ***Package C State Support [Auto]***

This item allows you to set the a C-state support for the CPU package. Configuration options: [Auto] [Enabled] [C0/C1] [C2] [C3] [C6] [CPU C7] [CPU C7s]

## **2.6.2 PCH Configuration**

### **Intel Rapid Start Technology**

#### **Intel® Rapid Start Technology [Disabled]**

Allows you to enable or disable Intel® Rapid Start Technology. Configuration options: [Enabled] [Disabled]



---

The following items appear only when you set the Intel® Rapid Start Technology to **[Enabled]**.

---

#### ***Entry on S3 RTC Wake [Enabled]***

The system automatically wakes up and set to Rapid Start Technology S3 mode. Configuration options: [Enabled] [Disabled]

#### ***Entry After [0]***

This item allows you to set the RTC wake-up timer at S3 entry. The time ranges from 0 minute (immediately) to 120 minutes.

### Active Page Threshold Support [Enabled]

The system automatically goes into sleep mode when the partition size is not enough for the Intel® Rapid Start Technology to work.

Configuration options: [Enabled] [Disabled]

#### Active Memory Threshold [0]

This item supports Intel Rapid Storage Technology when the partition size is greater than the Active Page Threshold size. When set to zero (0), it will go to Auto mode and checks if the partition size is enough at S3 entry.



---

Ensure that the caching partition size is larger than the total memory size.

---

### Hybrid Hard Disk Support [Disabled]

This item allows you to enable or disable the hybrid hard disk support for a faster resume time. Configuration options: [Enabled] [Disabled]

## Intel Smart Connect Technology [Disabled]

### Intel Smart Connect Technology Support [Disabled]

This item allows the system to support Intel Smart Connect Technology, that periodically refreshes selected applications when the system is in sleep mode.

Configuration options: [Enabled] [Disabled]

## 2.6.3 PCH Storage Configuration

While entering Setup, the BIOS automatically detects the presence of SATA devices. The SATA Port items show Empty if no SATA device is installed to the corresponding SATA port.

### SATA Mode Selection [AHCI]

Allows you to set the SATA configuration.

- |            |  |
|------------|--|
| [Disabled] | Disables the SATA function.  |
| [IDE]      | Set to [IDE] when you want to use the Serial ATA hard disk drives as Parallel ATA physical storage devices.  |
| [AHCI]     | Set to [AHCI] when you want the SATA hard disk drives to use the AHCI (Advanced Host Controller Interface). The AHCI allows the onboard storage driver to enable advanced Serial ATA features that increases storage performance on random workloads by allowing the drive to internally optimize the order of commands. |
| [RAID]     | Set to [RAID Mode] when you want to create a RAID configuration from the SATA hard disk drives.  |



---

The following item appears only when you set the SATA Mode Selection to **[RAID]**.

---

### Pcie Nand Configuration [Auto]

This item allows you to enable or disable PCIe NAND. Configuration options: [Auto] [Disabled] [Enabled]



### **Aggressive LPM Support [Disabled]**

This item is designed for LPM (link power management) support with a better energy saving conditions. When disabled, the hot plug function of SATA ports are disabled. Configuration options: [Disabled] [Enabled]

### **S.M.A.R.T. Status Check [On]**

S.M.A.R.T. (Self-Monitoring, Analysis and Reporting Technology) is a monitoring system that shows a warning message during POST (Power-on Self Test) when an error occurs in the hard disks. Configuration options: [On] [Off]

### **Hot Plug [Disabled] (SATA6G\_1 - SATA6G\_4)**

These items allow you to enable/disable SATA Hot Plug Support. Configuration options: [Disabled] [Enabled]

## **2.6.4 System Agent Configuration**

### **CPU Display Audio [Enabled]**

Enable this item to support CPU display audio output. Configuration options: [Enabled] [Disabled]

### **DVI Port Audio [Off]**

Enable this item to have an audio output when converting DVI to HDMI output. Configuration options: [On] [Off]

### **Graphics Configuration**

Allows you to select a primary display from CPU and PCIE graphical devices.

#### **Primary Display [Auto]**

Allows you to select the primary display from CPU and PCIE graphics devices. Configuration options: [Auto] [CPU Graphics] [PCIE]

#### **CPU Graphics Memory [Auto]**

Allows you to set the system memory size allocated to DVMT 5.0 used by the CPU graphics. Configuration options: [Auto] [32MB] [64MB] [96MB] [128MB] ~ [448MB] [480MB] [512MB]

#### **Render Standby [Auto]**

This item allows you to enable Intel® Graphics Render Standby support to reduce iGPU power use when the system is idle. Configuration options: [Auto] [Disabled] [Enabled]

#### **CPU Graphics Multi-Monitor [Disabled]**

This item allows you to empower both integrated and discrete graphics devices for the multi-monitor output. The CPU graphics shared system memory size is fixed at 64 MB. Configuration options: [Disabled] [Enabled]

### **DMI Configuration**

This item allows you to control various DMI (direct media interface) to run at PCI-E 2.0 speed.

#### **DMI Gen 2 [Enabled]**

Set this item to [Enabled] to run DMI at PCI-E 2.0 speed. Configuration options: [Enabled] [Disabled]

## NB PCI-E Configuration

Allows you to configure the NB PCI Express settings.

### PCI-Ex16\_1 Link Speed [Auto]

Allows you to configure the PCIEx16 speed for slot 1. Configuration options: [Auto] [Gen1] [Gen2] [Gen3]

## Memory Configuration

Allows you to configure the memory configuration parameters.

### Memory Scrambler [Enabled]

Set this item to **[Enabled]** to support high frequency DRAMs for a better stability. Configuration options: [Enabled] [Disabled]

### Memory Remap [Enabled]

Set this item to **[Enabled]** to support DRAM address remapping for 64-bit operating systems. Configuration options: [Enabled] [Disabled]

## 2.6.5 USB Configuration

The items in this menu allow you to change the USB-related features.



---

The **USB Devices** item shows the auto-detected values. If no USB device is detected, the item shows None.

---

### Legacy USB Support [Enabled]

- [Enabled] Your system supports the USB devices in legacy operating systems.
- [Disabled] Your USB devices can be used for BIOS setup only and cannot be recognized in the boot devices list.
- [Auto] Your system automatically detects the presence of USB devices at startup. If any USB devices are detected, the legacy USB support is enabled.

### Intel xHCI Mode [Smart Auto]

- [Auto] The xHCI is automatically enabled and runs at USB 3.0 mode when the xHCI driver is installed in the operating system.
- [Smart Auto] Upon detection, the xHCI driver supports the USB 3.0 mode during both POST and operating system.
- [Enabled] Enables the xHCI controller.
- [Disabled] Disables the xHCI controller.

### EHCI Hand-off [Disabled]

- [Enabled] Enables the support for operating systems without an EHCI hand-off feature.
- [Disabled] Disables the EHCI Hand-off support.

### Mass Storage Devices [Auto]

This item allows your system to detect the devices according to their media formats.

Configuration options: [Auto] [Floppy] [Forced FDD] [Hard Disk] [CD-ROM]

## USB Single Port Control

This item allows you to enable or disable the individual USB ports.



---

Refer to section **1.2.3 Motherboard layout** for the location of the USB ports.

---

## 2.6.6 Platform Misc Configuration

The items in this menu allow you to configure the platform-related features.

### PCIe Native Power Management [Disabled]

This item allows you to enhance the power saving feature of PCI Express and perform ASPM operations in the operating system. Configuration options: [Disabled] [Enabled]



---

The following item appears only when you set the PCI Express Native Power Management to [Enabled].

---

#### Native ASPM [Disabled]

[Enabled] Windows® Vista OS controls the ASPM (active state power management) support for devices.

[Disabled] BIOS controls the ASPM support for the device.

## PCH - PCI Express options

### DMI Link ASPM Control [Disabled]

This item allows you to control the Active State Power Management on both NB (NorthBridge) side and SB (SouthBridge) side of the DMI Link. Configuration options: [Disabled] [Enabled]

### ASPM Support [Disabled]

This item allows you to select the ASPM state for energy-saving conditions. Configuration options: [Disabled] [L0s] [L1] [L0sL1] [Auto]

## SA - PCI Express options

### DMI Link ASPM Control [Disabled]

This item allows you to control the Active State Power Management on both CPU and PCH (platform controller hub) Both DMI link ASPM control items of the CPU and PCH sides must be enabled for the ASPM to take effect. Configuration options: [Disabled] [L0s] [L1] [L0sL1]

### PEG ASPM Support [Disabled]

This item allows you to select the ASPM state for energy-saving conditions, or use the ASUS optimized energy saving profile. Configuration options: [Disabled] [Auto] [ASPM L0s] [L1] [L0sL1]

## 2.6.7 Onboard Devices Configuration

### HD Audio Controller [Enabled]

This item allows you to use the Azalia High Definition Audio Controller. Configuration options: [Disabled] [Enabled]



---

The following three items appear only when you set the HD Audio Controller item to **[Enabled]**.

---

### **Front Panel Type [HD]**

Allows you to set the front panel audio connector (AAFP) mode to legacy AC'97 or high-definition audio depending on the audio standard that the front panel audio module supports.

[HD] Sets the front panel audio connector (AAFP) mode to high definition audio.

[AC97] Sets the front panel audio connector (AAFP) mode to legacy AC'97

### **SPDIF Out Type [SPDIF]**

[SPDIF] Sets to an SPDIF audio output.

[HDMI] Sets to an HDMI audio output.

### **Depop [Enabled]**

Configuration options: [Disabled] [Enabled]

## **Intel LAN Controller [Enabled]**

This item allows you to enable or disable the Intel LAN controller. Configuration options: [Disabled] [Enabled]



---

The following item appears only when you set the **Intel LAN Controller** item to **[Enabled]**.

---

### **Intel LAN PXE Option ROM [Disabled]**

Allows you to enable or disable the PXE OptionRom of the Intel LAN controller. Configuration options: [Enabled] [Disabled]

### **Charging USB devices in Power State S5 [Disabled]**

[Enabled] Charges USB devices even when the system is in Power State S5. State S5 is the soft-off mode or shutdown state where your computer has no memory state and is not doing any computing tasks.

[Disabled] Disables this function.

## **2.6.8 APM**

### **Deep S4 [Disabled]**

When enabled, the system in S4 state will further reduce power usage and will power off the USB and PS/2 devices. The system in deep S4 state can be woken up via the power button, devices in LAN, or other ways except via the USB and PS/2 devices. Configuration options: [Disabled] [Enabled]

### **Restore AC Power Loss [Power Off]**

[Power On] The system goes into on state after an AC power loss.

[Power Off] The system goes into off state after an AC power loss.

[Last State] The system goes into either off or on state, whatever the system state was before the AC power loss.

### **Power On By PS/2 Keyboard [Disabled]**

- [Disabled] Disables the Power On by a PS/2 keyboard.
- [Space Bar] Sets the Space Bar on the PS/2 keyboard to turn on the system.
- [Ctrl-Esc] Sets the Ctrl+Esc key on the PS/2 keyboard to turn on the system.
- [Power Key] Sets Power key on the PS/2 keyboard to turn on the system. This feature requires an ATX power supply that provides at least 1A on the +5VSB lead.

### **Power On By PCIE [Disabled]**

This item allows you to enable or disable the Wake-on-LAN function of the onboard LAN controller or other installed PCIe LAN cards. Configuration options: [Disabled] [Enabled]

### **Power On By RTC [Disabled]**

This item allows you to enable or disable the RTC (Real-Time Clock) to generate a wake event and configure the RTC alarm date. When enabled, you can set the days, hours, minutes, or seconds to schedule an RTC alarm date. Configuration options: [Disabled] [Enabled]

## **2.6.9 Network Stack Configuration**

### **Network Stack [Disabled]**

This item allows user to disable or enable the UEFI network stack. Configuration options: [Disabled] [Enabled]



---

The following two items appear only when you set the previous item to [Enabled].

---

### **Ipv4 / Ipv6 PXE Support [Enabled]**

This item allows you to enable or disable the Ipv4/Ipv6 PXE wake event. Configuration options: [Disable Link] [Enabled]

## 2.7 Monitor menu

The Monitor menu displays the system temperature/power status, and allows you to change the fan settings.

Scroll down to display the other BIOS items.

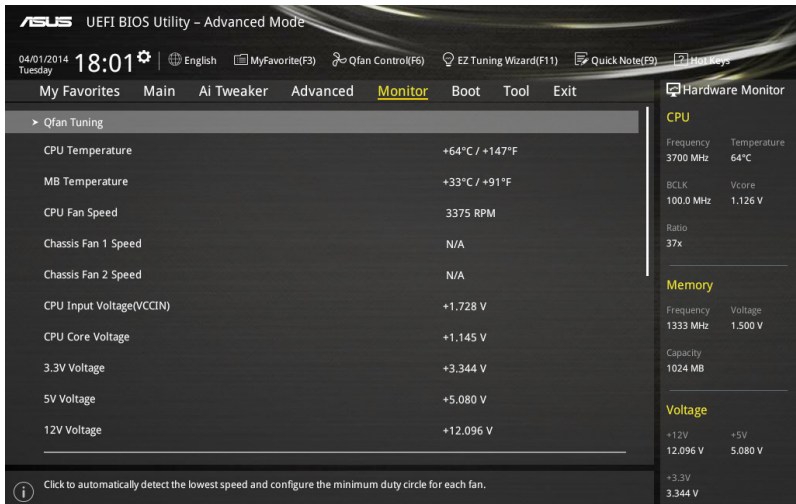

### 2.7.1 Qfan Tuning

Click this item to automatically detect the lowest speed and configure the minimum duty cycle for each fan.

### 2.7.2 CPU/ MB Temperature [xxx°C/xxx°F]/ [Ignore]

The onboard hardware monitor automatically detects and displays the CPU and motherboard temperatures. Select **[Ignore]** if you do not wish to display the detected temperatures.

### 2.7.3 CPU Fan/ Chassis Fan 1/2 Speed [xxxx RPM]/ [Ignore]/ [N/A]

The onboard hardware monitor automatically detects and displays the CPU and chassis fan 1/2 speeds in rotations per minute (RPM). If the fan is not connected to the motherboard, the field shows N/A. Select **[Ignore]** if you do not wish to display the detected speed.

### 2.7.4 CPU Input Voltage (VCCIN), CPU Core Voltage, 3.3V Voltage, 5V Voltage, 12V Voltage

The onboard hardware monitor automatically detects the voltage output through the onboard voltage regulators. Select **[Ignore]** if you do not want to detect this item.

### 2.7.5 CPU Q-Fan Control [Enabled]

[Enabled] Enables the CPU Q-Fan control feature.

[Disabled] Disables the CPU Q-Fan control feature.



---

The following items appear only when you set the **CPU Q-Fan Control** item to **[Enabled]**.

---

### **CPU Fan Speed Low Limit [200 RPM]**

This item appears only when you enable the CPU Q-Fan Control feature and allows you to disable or set the CPU fan warning speed. Configuration options: [Ignore] [100RPM] [200RPM] [300 RPM] [400 RPM] [500 RPM]

### **CPU Fan Profile [Standard]**

This item appears only when you enable the CPU Q-Fan Control feature and allows you to set the appropriate performance level of the CPU fan.

- [Standard] Sets to [Standard] to make the CPU fan automatically adjust depending on the CPU temperature.
- [Silent] Sets to [Silent] to minimize the fan speed for quiet CPU fan operation.
- [Turbo] Sets to [Turbo] to achieve maximum CPU fan speed.
- [Manual] Sets to [Manual] to assign detailed fan speed control parameters.



---

The following four items appear only when you set **CPU Fan Profile** to **[Manual]**.

---

### **CPU Upper Temperature [70]**

Use the <+> and <-> keys to adjust the upper limit of the CPU temperature. The values range from 25°C to 75°C.

### **CPU Fan Max. Duty Cycle(%) [100]**

Use the <+> and <-> keys to adjust the maximum CPU fan duty cycle. The values range from 20% to 100%. When the CPU temperature reaches the upper limit, the CPU fan will operate at the maximum duty cycle.

### **CPU Middle Temperature [45]**

Use the <+> or <-> keys to set the value for CPU Middle Temperature. The range of the values depends on the CPU installed.

### **CPU Fan Middle Duty Cycle(%) [60]**

Use the <+> or <-> keys to adjust the CPU fan middle duty cycle. The values range from 20% to 100%. When the CPU temperature reaches the upper limit, the CPU fan operates at the maximum duty cycle.

### **CPU Lower Temperature [40]**

Use the <+> or <-> keys to adjust the CPU fan's lower temperature. The values range from 20% to 75%.

### **CPU Fan Min. Duty Cycle(%) [60]**

Use the <+> and <-> keys to adjust the minimum CPU fan duty cycle. The values range from 20% to 100%. When the CPU temperature is under the lower limit, the CPU fan will operate at the minimum duty cycle.

## **2.7.6 Chassis Fan 1/2 Q-Fan Control [DC Mode]**

- [PWM mode] Enables the chassis Q-Fan control in PWM mode for 4-pin chassis fan.
- [DC mode] Enables the chassis Q-Fan control in DC mode for 3-pin chassis fan.
- [Disabled] Disables the chassis Q-Fan control feature.



---

The following items appear only when you set the Chassis Fan 1/2 Q-Fan Control to **[PWM Mode]** or **[DC Mode]**.

---

### **Chassis Fan 1/2 Q-Fan Source [CPU]**

This item controls the assigned fan according to the selected temperature source.  
Configuration options: [CPU] [MB]

### **Chassis Fan 1/2 Speed Low Limit [600 RPM]**

This item allows you to disable or set the chassis fan warning speed. Configuration options: [Ignore] [200RPM] [300 RPM] [400 RPM] [500 RPM] [600 RPM]

### **Chassis Fan 1/2 Profile [Standard]**

This item allows you to set the appropriate performance level of the chassis fan.

- [Standard] Sets to [Standard] to make the chassis fan automatically adjust depending on the chassis temperature.
- [Silent] Sets to [Silent] to minimize the fan speed for quiet chassis fan operation.
- [Turbo] Sets to [Turbo] to achieve maximum chassis fan speed.
- [Manual] Sets to [Manual] to assign detailed fan speed control parameters.



---

The following four items appear only when you set **Chassis Fan 1/2 Profile** to [Manual].

---

### **Chassis Fan 1/2 Upper Temperature [70]**

Use the <+> or <-> keys to adjust the upper limit of the CPU temperature. The values range from 45°C to 75°C.

### **Chassis Fan 1/2 Max. Duty Cycle(%) [100]**

Use the <+> or <-> keys to adjust the maximum chassis fan duty cycle. The values range from 60% to 100%. When the chassis temperature reaches the upper limit, the chassis fan will operate at the maximum duty cycle.

### **Chassis Fan 1/2 Middle Temperature [45]**

Use the <+> or <-> keys to set the value for Chassis Fan Middle Temperature.

### **Chassis Fan 1/2 Middle Duty Cycle(%) [60]**

Use the <+> or <-> keys to adjust the chassis fan middle duty cycle. The values range from 60% to 100%.

### **Chassis Fan 1/2 Lower Temperature [40]**

Use the <+> or <-> keys to adjust the chassis fans' lower temperature. The values range from 40% to 75%.

### **Chassis Fan 1/2 Min. Duty Cycle(%) [60]**

Use the <+> or <-> keys to adjust the minimum chassis fan duty cycle. The values range from 60% to 100%. When the CPU temperature is under the lower limit, the chassis fan operates at the minimum duty cycle.

## **2.7.7 Anti Surge Support [Disabled]**

This item allows you to enable or disable the Anti Surge function. Configuration options: [Disabled] [Enabled]



## 2.8 Boot menu

The Boot menu items allow you to change the system boot options.

Scroll down to display the other BIOS items.

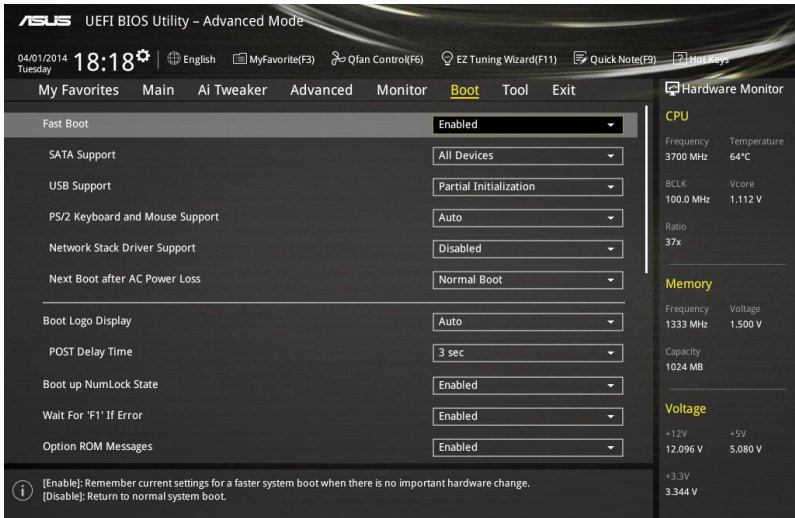

### 2.8.1 Fast Boot [Enabled]

[Enabled] Select to accelerate the boot speed.

[Disabled] Select to go back to normal boot speed.

#### SATA Support [All Devices]

[All Devices] All devices connected to SATA ports are available during POST. This process extends the POST time.

[Hard Drive Only] Only hard drives connected to SATA ports are detected during POST.

[Boot Drive Only] Only boot drives connected to a SATA ports are detected during POST.

#### USB Support [Partial Initialization]

[Disabled] All USB devices will not be available until OS boot up for a fastest POST time.

[Full Initialization] All USB devices will be available during POST. This process will extend the POST time.

[Partial Initialization] For a faster POST time, only the USB ports with keyboard and mouse connections will be detected.

## PS/2 Keyboard and Mouse Support [Auto]

Select any of these settings when PS/2 keyboard and mouse are installed. These settings only apply when Fast Boot is enabled.

[Auto] For a faster POST time, PS/2 devices will only be available when the system boots up or rebooted when the PS/2 devices have not been reconnected or changed. If you disconnect or change PS/2 devices before restarting the system, PS/2 devices will not be available and BIOS setup program will not be accessible via PS/2 devices.

[Full Initialization] For full system control, PS/2 devices will be available during POST at any circumstances. This process will extend POST time.

[Disabled] For the fastest POST time, all PS/2 devices will not be available until your computer enters the operating system.

## Network Stack Driver Support [Disabled]

[Disabled] Select to skip the network stack driver from loading during POST.

[Enabled] Select to load the network stack driver during POST.

## Next Boot after AC Power Loss [Normal Boot]

[Normal Boot] Returns to normal boot on the next boot after AC power loss.

[Fast Boot] Accelerates the boot speed on the next boot after AC power loss.

## 2.8.2 Boot Logo Display [Auto]

[Auto] Adjusts logo automatically based on Windows® display requirements.

[Full Screen] Maximize the boot logo size.

[Disabled] Hide the logo during POST.

## POST Delay Time [3 sec]

This item appears only when you set Boot Logo Display to [Auto] and [Full Screen]. This item allows you to select the desired additional POST waiting time to easily enter the BIOS setup. You can only execute the POST delay time during Normal Boot. The values range from 0 to 10 seconds.



---

This feature will only work under normal boot.

---

## Post Report [5 sec]

This item appears only when you set Boot Logo Display to [Disabled]. This item allows you to select a desired post report waiting time. Configuration options: [1 sec] ~ [10 sec] [Until Press ESC].

## 2.8.3 Bootup NumLock State [Enabled]

This item allows you to enable or disable power-on state of the NumLock. Configuration options: [Disabled] [Enabled]

## 2.8.4 Wait for 'F1' If Error [Enabled]

When this item is set to [Enabled], the system waits for the F1 key to be pressed when error occurs. Configuration options: [Disabled] [Enabled]

## 2.8.5 Option ROM Messages [Enabled]

[Enabled] The third-party ROM messages will be displayed during POST.

[Disabled] Disables the ROM messages and displays only the ASUS logo during POST.

## 2.8.6 Interrupt 19 Capture [Disabled]

This item allows you to trap Interrupt 19 by the option ROMs. Configuration options: [Disabled] [Enabled]

## 2.8.7 Above 4G Decoding [Disabled]

This item allows you to decode the 64-bit capable devices above 4G address space. Ensure that your system supports 64-bit PCI decoding. Configuration options: [Disabled] [Enabled]

## 2.8.8 Setup Mode [EZ Mode]

[Advanced Mode] This item allows you to go to Advanced Mode of the BIOS after POST.

[EZ Mode] This item allows you to go to EZ Mode of the BIOS after POST.

## 2.8.9 CSM (Compatibility Support Module)

Allows you to configure the CSM (Compatibility Support Module) items to fully support the various VGA, bootable devices and add-on devices for better compatibility.

### Launch CSM [Enabled]

[Auto] The system automatically detects the bootable devices and the add-on devices.

[Enabled] For better compatibility, enable the CSM to fully support the non-UEFI driver add-on devices or the Windows® UEFI mode.

[Disabled] Disable the CSM to fully support the Windows® Security Update and Security Boot.



---

The following four items appear when you set Launch CSM to [Enabled].

---

### Boot Devices Control [UEFI and Legacy OpROM]

Allows you to select the type of devices that you want to boot up. Configuration options: [UEFI and Legacy OpROM] [Legacy OpROM only] [UEFI only]

### Boot from Network Devices [Legacy OpROM first]

Allows you to select the type of network devices that you want to launch. Configuration options: [Legacy OpROM first] [UEFI driver first] [Ignore]

### Boot from Storage Devices [Legacy OpROM first]

Allows you to select the type of storage devices that you want to launch. Configuration options: [Both, Legacy OpROM first] [Both, UEFI first] [Legacy OpROM first] [UEFI driver first] [Ignore]

### Boot from PCI-E/PCI Expansion Devices [Legacy OpROM first]

Allows you to select the type of PCIe/PCI expansion devices that you want to launch. Configuration options: [Legacy OpROM first] [UEFI driver first]

## 2.8.10 Secure Boot

Allows you to configure the Windows® Secure Boot settings and manage its keys to protect the system from unauthorized access and malwares during POST.

### OS Type [Windows UEFI mode]

Allows you to select your installed operating system.

[Windows UEFI mode] This item allows you to select your installed operating system. Execute the Microsoft® Secure Boot check. Only select this option when booting on Windows® UEFI mode or other Microsoft® Secure Boot compliant OS.

[Other OS] Get the optimized function when booting on Windows® non-UEFI mode. Microsoft® Secure Boot only supports Windows® UEFI mode.

### Key Management

This allows you to manage the Secure Boot keys.

#### Install Default Secure Boot keys

This item allows you to immediately load the default Security Boot keys, Platform key (PK), Key-exchange Key (KEK), Signature database (db), and Revoked Signatures (dbx). When the default Secure boot keys are loaded, all the Secure Boot keys' state will change from Unloaded mode to loaded mode.

#### Clear Secure Boot keys

This item appears only when you load the default Secure Boot keys. This item allows you to clear all the previously applied Secure Boot keys.

#### Save Secure Boot Keys

This item allows you to save all the Secure Boot keys to a USB storage device.

#### PK Management

The Platform Key (PK) locks and secures the firmware from any non-permissible changes. The system verifies the PK before your system enters the OS.

##### *Delete PK*

Allows you to delete the PK from your system. Once the PK is deleted, all the system's Secure Boot keys will not be active.

##### *Load Default PK*

Select Yes to load the system default PK or select No to load a downloaded PK from a USB storage device.



---

The PK file must be formatted as a UEFI variable structure with time-based authenticated variable.

---

## KEK Management

The KEK (Key-exchange Key or Key Enrollment Key) manages the Signature database (db) and Revoked Signature database (dbx).



---

Key-exchange Key (KEK) refers to Microsoft® Secure Boot Key-Enrollment Key (KEK).

---

### **Delete KEK**

Allows you to delete the KEK from your system. Once the KEK is deleted, the db and the dbx cannot be updated in the operating system.

### **Load Default KEK**

Select Yes to load the system default KEK or select No to load a downloaded KEK from a USB storage device.

### **Append Default KEK**

Select Yes to append the system default KEK or select No to append a downloaded additional KEK from a USB storage device for the db and dbx management.



---

The KEK file must be formatted as a UEFI variable structure with time-based authenticated variable.

---

## DB Management

The db (Authorized Signature database) lists the signers or images of UEFI applications, operating system loaders, and UEFI drivers that you can load on the single computer.

### **Delete the db**

Allows you to delete the db file from your system. Doing so may cause boot failures.

### **Load Default db**

Select Yes to load the system default db or select No to load a downloaded db from a USB storage device.

### **Append Default db**

Select Yes to append the system default db or select No to append a downloaded additional db from a USB storage device to load certain customized UEFI executable files.



- 
- The DB file must be formatted as a UEFI variable structure with time-based authenticated variable.
  - UEFI executable files include UEFI boot devices, drivers and applications.
- 

## dbx Management

The dbx (Revoked Signature database) lists the forbidden images of db items that are no longer trusted and cannot be loaded.

### **Delete the dbx**

Allows you to delete the DBX file from your system. Doing so may expose the system to security threats.

### **Load Default dbx**

Select Yes to load the system default dbx or select No to load a downloaded dbx from a USB storage device.

### ***Append Default dbx***

Select Yes to append the system default dbx or select No to append a downloaded additional dbx from a USB storage device to forbid certain customized UEFI executable files.



---

The DBX file must be formatted as a UEFI variable structure with time-based authenticated variable.

---

## **2.8.11 Boot Option Priorities**

These items specify the boot device priority sequence from the available devices. The number of device items that appears on the screen depends on the number of devices installed in the system.



- To access Windows® OS in Safe Mode, press <F8 > after POST (Windows® 8 not supported).
  - To select the boot device during system startup, press <F8> when ASUS Logo appears.
- 

## **2.8.12 Boot Override**

These items displays the available devices. The number of device items that appears on the screen depends on the number of devices installed in the system. Click an item to start booting from the selected device.

## 2.9 Tool menu

The Tool menu items allow you to configure options for special functions. Select an item then press <Enter> to display the submenu.

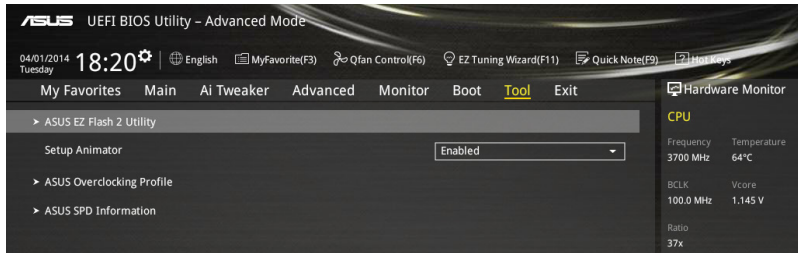

### 2.9.1 ASUS EZ Flash 2 Utility

Allows you to run ASUS EZ Flash 2. Press [Enter] to launch the ASUS EZ Flash 2 screen.



For more details, see section 2.1.2 **ASUS EZ Flash 2**.

### 2.9.2 Setup Animator [Enabled]

Enables or disables the Setup animator. Configuration options: [Disabled] [Enabled]

### 2.9.3 ASUS Overclocking Profile

This item allows you to store or load multiple BIOS settings.



The **Overclocking Profile** items show **Not assigned** if no profile is created.

#### Load from Profile

Allows you to load the previous BIOS settings saved in the BIOS Flash. Key in the profile number that saved your CMOS settings, press <Enter>, and then select Yes.



- DO NOT shut down or reset the system while updating the BIOS to prevent the system boot failure!
- We recommend that you update the BIOS file only coming from the same memory/CPU configuration and BIOS version.

#### Profile Name

Allows you to create a name for the profile you want to save.

#### Save to Profile

Allows you to save the current BIOS settings to the BIOS Flash, and create a profile. Key in a profile number from one to eight, press <Enter>, and then select Yes.

#### Load/Save Profile from/to USB Drive

This item allows you to load or save profile from your USB drive, load and save profile to your USB drive.

## 2.9.4 ASUS SPD Information

### DIMM Slot number [DIMM\_A1]

Displays the Serial Presence Detect (SPD) information of the DIMM module installed on the selected slot. Configuration options: [DIMM\_A1] [DIMM\_B1]

## 2.10 Exit menu

The Exit menu items allow you to load the optimal default values for the BIOS items, and save or discard your changes to the BIOS items.

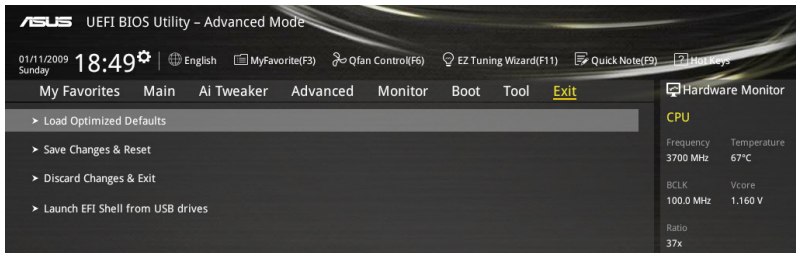

### Load Optimized Defaults

This option allows you to load the default values for each of the parameters on the Setup menus. When you select this option or if you press <F5>, a confirmation window appears. Select OK to load the default values.

### Save Changes & Reset

Once you are finished making your selections, choose this option from the Exit menu to ensure the values you selected are saved. When you select this option or if you press <F10>, a confirmation window appears. Select OK to save changes and exit.

### Discard Changes & Exit

This option allows you to exit the Setup program without saving your changes. When you select this option or if you press <Esc>, a confirmation window appears. Select OK to discard changes and exit.

### Launch EFI Shell from USB drives

This option allows you to attempt to launch the EFI Shell application (shellx64.efi) from one of the available USB devices.



# Appendices

## Notices

### Federal Communications Commission Statement

This device complies with Part 15 of the FCC Rules. Operation is subject to the following two conditions:

- This device may not cause harmful interference.
- This device must accept any interference received including interference that may cause undesired operation.

This equipment has been tested and found to comply with the limits for a Class B digital device, pursuant to Part 15 of the FCC Rules. These limits are designed to provide reasonable protection against harmful interference in a residential installation. This equipment generates, uses and can radiate radio frequency energy and, if not installed and used in accordance with manufacturer's instructions, may cause harmful interference to radio communications. However, there is no guarantee that interference will not occur in a particular installation. If this equipment does cause harmful interference to radio or television reception, which can be determined by turning the equipment off and on, the user is encouraged to try to correct the interference by one or more of the following measures:

- Reorient or relocate the receiving antenna.
- Increase the separation between the equipment and receiver.
- Connect the equipment to an outlet on a circuit different from that to which the receiver is connected.
- Consult the dealer or an experienced radio/TV technician for help.



---

The use of shielded cables for connection of the monitor to the graphics card is required to assure compliance with FCC regulations. Changes or modifications to this unit not expressly approved by the party responsible for compliance could void the user's authority to operate this equipment.

---

### IC: Canadian Compliance Statement

Complies with the Canadian ICES-003 Class B specifications. This device complies with RSS 210 of Industry Canada. This Class B device meets all the requirements of the Canadian interference-causing equipment regulations.

This device complies with Industry Canada license exempt RSS standard(s). Operation is subject to the following two conditions: (1) this device may not cause interference, and (2) this device must accept any interference, including interference that may cause undesired operation of the device.

Cet appareil numérique de la Classe B est conforme à la norme NMB-003 du Canada.

Cet appareil numérique de la Classe B respecte toutes les exigences du Règlement sur le matériel brouilleur du Canada.

Cet appareil est conforme aux normes CNR exemptes de licence d'Industrie Canada. Le fonctionnement est soumis aux deux conditions suivantes :

- (1) cet appareil ne doit pas provoquer d'interférences et
- (2) cet appareil doit accepter toute interférence, y compris celles susceptibles de provoquer un fonctionnement non souhaité de l'appareil.

## Canadian Department of Communications Statement

This digital apparatus does not exceed the Class B limits for radio noise emissions from digital apparatus set out in the Radio Interference Regulations of the Canadian Department of Communications.

This class B digital apparatus complies with Canadian ICES-003.

## VCCI: Japan Compliance Statement

この装置は、クラスB情報技術装置です。この装置は、家庭環境で使用することを目的としていますが、この装置がラジオやテレビジョン受信機に近接して使用されると、受信障害を引き起こすことがあります。

取扱説明書に従って正しい取り扱いをして下さい。

V C C I - B

This is a Class B product based on the standard of the VCCI Council. If this is used near a radio or television receiver in a domestic environment, it may cause radio interference. Install and use the equipment according to the instruction manual.

## KC: Korea Warning Statement

**B급 기기 (가정용 방송통신기자재)**

이 기기는 가정용(B급) 전자파적합기기로서 주로 가정에서 사용하는 것을 목적으로 하며, 모든 지역에서 사용할 수 있습니다.

\*당해 무선설비는 전파혼신 가능성이 있으므로 인명안전과 관련된 서비스는 할 수 없습니다.

## REACH

Complying with the REACH (Registration, Evaluation, Authorisation, and Restriction of Chemicals) regulatory framework, we published the chemical substances in our products at ASUS REACH website at <http://csr.asus.com/english/REACH.htm>.



DO NOT throw the motherboard in municipal waste. This product has been designed to enable proper reuse of parts and recycling. This symbol of the crossed out wheeled bin indicates that the product (electrical and electronic equipment) should not be placed in municipal waste. Check local regulations for disposal of electronic products.



DO NOT throw the mercury-containing button cell battery in municipal waste. This symbol of the crossed out wheeled bin indicates that the battery should not be placed in municipal waste.

## ASUS Recycling/Takeback Services

ASUS recycling and takeback programs come from our commitment to the highest standards for protecting our environment. We believe in providing solutions for you to be able to responsibly recycle our products, batteries, other components as well as the packaging materials. Please go to <http://csr.asus.com/english/Takeback.htm> for detailed recycling information in different regions.

## ASUS contact information

### ASUSTeK COMPUTER INC.

Address 15 Li-Te Road, Peitou, Taipei, Taiwan 11259  
Telephone +886-2-2894-3447  
Fax +886-2-2890-7798  
E-mail [info@asus.com.tw](mailto:info@asus.com.tw)  
Web site <http://www.asus.com>

#### ***Technical Support***

Telephone +86-21-3842-9911  
Fax +86-21-5866-8722 ext. 9101#  
Online support <http://support.asus.com/techserv/techserv.aspx>

### ASUS COMPUTER INTERNATIONAL (America)

Address 800 Corporate Way, Fremont, CA 94539, USA  
Telephone +1-510-739-3777  
Fax +1-510-608-4555  
Web site <http://www.asus.com/us/>

#### ***Technical Support***

Support fax +1-812-284-0883  
General support +1-812-282-2787  
Online support <http://www.service.asus.com/>

### ASUS COMPUTER GmbH (Germany and Austria)

Address Harkort Str. 21-23, D-40880 Ratingen, Germany  
Fax +49-2102-959931  
Web site <http://www.asus.com/de>  
Online contact <http://eu-rma.asus.com/sales>

#### ***Technical Support***

Telephone +49-2102-5789555  
Support Fax +49-2102-959911  
Online support <http://www.asus.com/de/support/>

# DECLARATION OF CONFORMITY

Per FCC Part 2, Section 2.1077(a)



Responsible Party Name: **Asus Computer International**

Address: **800 Corporate Way, Fremont, CA 94539.**

Phone/Fax No: **(510)739-3777/(510)608-4555**

hereby declares that the product

**Product Name : Motherboard**

**Model Number : H97-PLUS**

Conforms to the following specifications:

FCC Part 15, Subpart B, Unintentional Radiators

### Supplementary Information:

This device complies with part 15 of the FCC Rules. Operation is subject to the following two conditions: (1) This device may not cause harmful interference, and (2) this device must accept any interference received, including interference that may cause undesired operation.

Representative Person's Name : Steve Chang / President

*Steve Chang*

Signature :

Date : Apr. 17, 2014

Ver: 140331

# EC Declaration of Conformity



We, the undersigned,

Manufacturer: **ASUS (K) COMPUTER INC.**  
Address: **NO. 1, FUJIFUJI, TAIPEI 112, TAIWAN**  
Authorized representative in Europe: **ASUS COMPUTER EUROPE**  
Address: **HARGREAVE STR. 21-23, OBERHOFEN/RATTINGEN**  
Country: **GERMANY**

declare the following apparatus:

Product name : **Motherboard**  
Model name : **H97-PLUS**

conform with the essential requirements of the following directives:

**2004/108/EC-EMC Directive**  
 EN 55022:2010/A2:2011  
 EN 61000-3-2:2006/A2:2009  
 EN 55015:2010/A1:2010/A2:2006  
 EN 55020:2007/A1:2011

### UN99-CE-RED Directive

EN 300 440-1 V1.6.1 (2010-08)  
 EN 300 440-2 V1.4.1 (2010-08)  
 EN 300 440-3 V1.4.1 (2010-08)  
 EN 300 440-4 V1.4.1 (2010-08)  
 EN 300 440-5 V1.4.1 (2010-11)  
 EN 301 908-1 V1.5.2 (2011-05)  
 EN 301 908-2 V1.5.2 (2011-07)  
 EN 301 908-3 V1.5.2 (2012-09)  
 EN 302 542-1 V1.1.1 (2009-01)  
 EN 302 542-2 V1.1.1 (2009-01)  
 EN 302 542-3 V1.3.1 (2007-09)  
 EN 302 542-4 V1.3.1 (2007-09)  
 EN 302 542-5 V1.1.1 (2006-07)  
 EN 302 542-6 V1.1.1 (2006-07)  
 EN 302 542-7 V1.1.1 (2006-07)  
 EN 302 542-8 V1.1.1 (2006-07)  
 EN 302 542-9 V1.1.1 (2006-07)  
 EN 302 542-10 V1.1.1 (2006-07)  
 EN 302 542-11 V1.1.1 (2006-07)  
 EN 302 542-12 V1.1.1 (2006-07)  
 EN 302 542-13 V1.1.1 (2006-07)  
 EN 302 542-14 V1.1.1 (2006-07)  
 EN 302 542-15 V1.1.1 (2006-07)  
 EN 302 542-16 V1.1.1 (2006-07)  
 EN 302 542-17 V1.1.1 (2006-07)  
 EN 302 542-18 V1.1.1 (2006-07)  
 EN 302 542-19 V1.1.1 (2006-07)  
 EN 302 542-20 V1.1.1 (2006-07)  
 EN 302 542-21 V1.1.1 (2006-07)  
 EN 302 542-22 V1.1.1 (2006-07)  
 EN 302 542-23 V1.1.1 (2006-07)  
 EN 302 542-24 V1.1.1 (2006-07)  
 EN 302 542-25 V1.1.1 (2006-07)  
 EN 302 542-26 V1.1.1 (2006-07)  
 EN 302 542-27 V1.1.1 (2006-07)  
 EN 302 542-28 V1.1.1 (2006-07)  
 EN 302 542-29 V1.1.1 (2006-07)  
 EN 302 542-30 V1.1.1 (2006-07)  
 EN 302 542-31 V1.1.1 (2006-07)  
 EN 302 542-32 V1.1.1 (2006-07)  
 EN 302 542-33 V1.1.1 (2006-07)  
 EN 302 542-34 V1.1.1 (2006-07)  
 EN 302 542-35 V1.1.1 (2006-07)  
 EN 302 542-36 V1.1.1 (2006-07)  
 EN 302 542-37 V1.1.1 (2006-07)  
 EN 302 542-38 V1.1.1 (2006-07)  
 EN 302 542-39 V1.1.1 (2006-07)  
 EN 302 542-40 V1.1.1 (2006-07)  
 EN 302 542-41 V1.1.1 (2006-07)  
 EN 302 542-42 V1.1.1 (2006-07)  
 EN 302 542-43 V1.1.1 (2006-07)  
 EN 302 542-44 V1.1.1 (2006-07)  
 EN 302 542-45 V1.1.1 (2006-07)  
 EN 302 542-46 V1.1.1 (2006-07)  
 EN 302 542-47 V1.1.1 (2006-07)  
 EN 302 542-48 V1.1.1 (2006-07)  
 EN 302 542-49 V1.1.1 (2006-07)  
 EN 302 542-50 V1.1.1 (2006-07)  
 EN 302 542-51 V1.1.1 (2006-07)  
 EN 302 542-52 V1.1.1 (2006-07)  
 EN 302 542-53 V1.1.1 (2006-07)  
 EN 302 542-54 V1.1.1 (2006-07)  
 EN 302 542-55 V1.1.1 (2006-07)  
 EN 302 542-56 V1.1.1 (2006-07)  
 EN 302 542-57 V1.1.1 (2006-07)  
 EN 302 542-58 V1.1.1 (2006-07)  
 EN 302 542-59 V1.1.1 (2006-07)  
 EN 302 542-60 V1.1.1 (2006-07)  
 EN 302 542-61 V1.1.1 (2006-07)  
 EN 302 542-62 V1.1.1 (2006-07)  
 EN 302 542-63 V1.1.1 (2006-07)  
 EN 302 542-64 V1.1.1 (2006-07)  
 EN 302 542-65 V1.1.1 (2006-07)  
 EN 302 542-66 V1.1.1 (2006-07)  
 EN 302 542-67 V1.1.1 (2006-07)  
 EN 302 542-68 V1.1.1 (2006-07)  
 EN 302 542-69 V1.1.1 (2006-07)  
 EN 302 542-70 V1.1.1 (2006-07)  
 EN 302 542-71 V1.1.1 (2006-07)  
 EN 302 542-72 V1.1.1 (2006-07)  
 EN 302 542-73 V1.1.1 (2006-07)  
 EN 302 542-74 V1.1.1 (2006-07)  
 EN 302 542-75 V1.1.1 (2006-07)  
 EN 302 542-76 V1.1.1 (2006-07)  
 EN 302 542-77 V1.1.1 (2006-07)  
 EN 302 542-78 V1.1.1 (2006-07)  
 EN 302 542-79 V1.1.1 (2006-07)  
 EN 302 542-80 V1.1.1 (2006-07)  
 EN 302 542-81 V1.1.1 (2006-07)  
 EN 302 542-82 V1.1.1 (2006-07)  
 EN 302 542-83 V1.1.1 (2006-07)  
 EN 302 542-84 V1.1.1 (2006-07)  
 EN 302 542-85 V1.1.1 (2006-07)  
 EN 302 542-86 V1.1.1 (2006-07)  
 EN 302 542-87 V1.1.1 (2006-07)  
 EN 302 542-88 V1.1.1 (2006-07)  
 EN 302 542-89 V1.1.1 (2006-07)  
 EN 302 542-90 V1.1.1 (2006-07)  
 EN 302 542-91 V1.1.1 (2006-07)  
 EN 302 542-92 V1.1.1 (2006-07)  
 EN 302 542-93 V1.1.1 (2006-07)  
 EN 302 542-94 V1.1.1 (2006-07)  
 EN 302 542-95 V1.1.1 (2006-07)  
 EN 302 542-96 V1.1.1 (2006-07)  
 EN 302 542-97 V1.1.1 (2006-07)  
 EN 302 542-98 V1.1.1 (2006-07)  
 EN 302 542-99 V1.1.1 (2006-07)  
 EN 302 542-100 V1.1.1 (2006-07)

### 2006/95/EC-LVD Directive

EN 60950-1 /A12:2011  
 EN 60950-2:2002 /A12:2011

### 2009/125/EC-EP Directive

Regulation (EC) No. 1275/2008  
 Regulation (EC) No. 642/2009

### 2011/65/EU-RoHS Directive

**CE marking**



(EC conformity marking)

Position : **CEO**  
Name : **Jerry Shen**

*Jerry Shen*

Signature : \_\_\_\_\_

Declaration Date: **17/04/2014**  
Year to begin affixing CE marking: **2014**

Ver: 140331