



PORTABLE WIRELESS SPEAKER WITH OPTIONAL POST-MOUNT

MODEL AW827 INSTALLATION AND OPERATION MANUAL

IMPORTANT INFORMATION

CAUTION
RISK OF ELECTRIC SHOCK.
DO NOT OPEN.

Caution: To reduce the risk of electric shock, do not remove cover (or back). No user serviceable parts inside. Refer servicing to qualified service personnel.

Important Safety Instructions

1. Read these instructions.
2. Keep these instructions.
3. Heed all warnings.
4. Follow all instructions.
5. Clean only with dry cloth.
6. Do not block any ventilation openings. Install in accordance with the manufacturer's instructions.
7. Do not install near any heat sources such as radiators, heat registers, stoves, or other apparatus (including amplifiers) that produce heat.
8. Protect the power cord from being walked on or pinched particularly at plugs, convenience receptacles, and the point where they exit from the apparatus.
9. Unplug this apparatus during lightning storms or when unused for long periods of time.
10. Refer all servicing to qualified service personnel. Servicing is required when the apparatus has been damaged in any way, such as power-supply cord or plug is damaged, liquid has been spilled or objects have fallen into the apparatus, the apparatus has been exposed to rain or moisture, does not operate normally, or has been dropped.

Care and Maintenance

- Always use a soft cloth to clean the speaker and transmitter. Never use any product containing alcohol or other solvents as they may damage the surface.
- Use caution when plugging the power transformers in an AC outlet to avoid the risk of electric shock.
- If the speaker are used outside on a deck or patio, make sure you take them indoors in the event of a rainstorm to prevent possible damage.
- Do not operate or store the system in extreme temperatures (below 32°F/0°C and above 122°F/50°C).
- To avoid electrical shock, use this product with caution near water sources if powered with the AC adapter. Never submerge in water.

Product Information

Keep your sales receipt to obtain warranty parts and service and for proof of purchase. Attach it here and record the serial and model numbers in case you need them. These numbers are located on the product.

Model No.: _____
Purchase Date: _____
Dealer/Address/Phone: _____

INTRODUCTION

AR's Wireless Speaker System eliminates the hardest part of adding speakers to your home—running and hiding hundreds of feet of speaker wire. The AR Wireless Speaker System's RF signal travels with ease through walls, floors, ceilings and other obstacles, delivering high-quality sound virtually anywhere inside the house or out. With drift- and static-free reception along with outstanding range—up to 150 feet*—the possibilities for enjoying your AR Wireless Speaker System are nearly unlimited. The AR Wireless Speaker System is compatible with most audio sources, such as A/V receivers/amps, stereos, computers, TVs, DVD players, and portable devices (CD players, cassette players, MP3s etc.). The post-top mount plate included with this speaker lets you put the AW827 securely on top of a standard 4"x4" post.

This manual covers various connection options and detailed operating instructions for making the AR Wireless Speaker System a valued part of your lifestyle. If, after having reviewed the instructions, you have any questions, please call toll-free 1-800-732-6866 or visit www.araccessories.com.

*Range may vary according to environment.

TOUR OF THE SPEAKER SYSTEM

Speaker

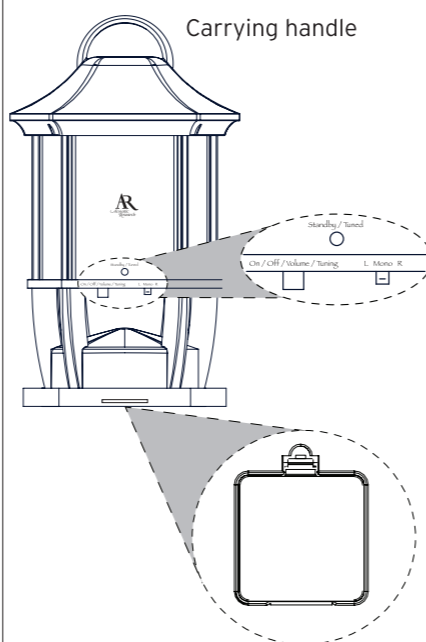

Front Panel

Standby/Tuned indicator turns red when the speaker is first turned on; it turns green when the speaker is tuned to the transmitter

On/Off/Volume/Tuning button turns the speaker on and off (push and hold), adjusts the speaker's volume (turn), and tunes the speaker to the transmitter if you are having problems linking (push).

L/Mono/R switch determines if the speaker plays sound in mono as a stand-alone speaker, or plays the left or right track in a stereo pair with an additional AR wireless speaker

Bottom Panel

Battery Compartment Cover remove to install 4 AA batteries

Transmitter

Front Panel

POWER indicator lights blue when audio is present and the transmitter is broadcasting

Back Panel

CHANNEL 1 2 3 lets you find the best transmission frequency for your environment

DC INPUT jack receives the small round end of the included 12V 100mA AC power adapter

ANALOG INPUT cable (built in) connects to your sound source using one of the connection options shown here

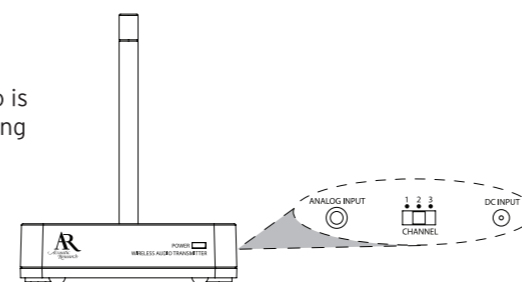

Included Accessories

Note: This power unit should be plugged in so that it stays vertical or lies flat.

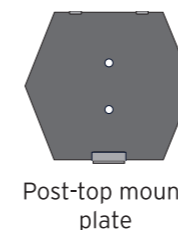
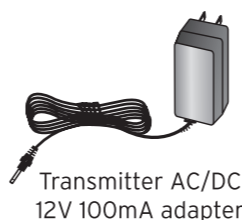

SETTING UP THE SPEAKER SYSTEM

Powering the Transmitter

Connect the small, round plug from the transmitter AC power adapter to the transmitter's DC INPUT jack. Plug the other end of the transmitter AC power adapter into any standard 120V AC wall outlet.

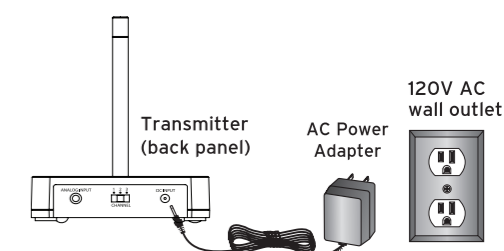

Note: There is no transmitter ON/OFF switch. The transmitter is designed to be left plugged in and powered at all times. If you will not be using the AW827 for an extended period of time, unplug the transmitter AC power adapter.

Connecting to an Audio Source

Connecting to an MP3 player, CD player, or computer

Plug the transmitter's built-in AUDIO INPUT cable into headphone output of your MP3 player or CD player (or audio output jack on your computer).

Warning: This product is designed to work with line level outputs or headphone outputs only. **DO NOT** connect it directly to speaker outputs as it will permanently damage the transmitter.

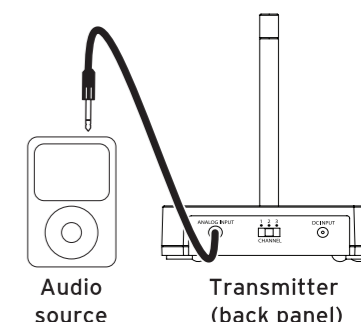

Connecting to an A/V Receiver

1. Plug the transmitter's built-in AUDIO INPUT cable into a mini-jack to RCA adapter (not included).
2. Connect the stereo plugs on the mini-jack to RCA adapter to the corresponding left and right audio outputs of your A/V receiver, amp, or other audio source.

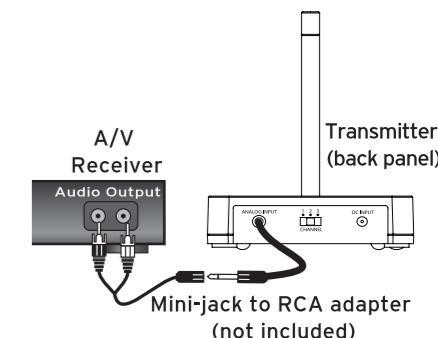

Installing Batteries in the Speaker

1. Remove the battery compartment cover on the bottom of the speaker.
2. Insert four (4) AA batteries (not included) into the speaker following the polarity ("+" and "-") as diagrammed inside the battery compartment.
3. Replace the battery compartment cover on the bottom of the speaker.

DO NOT mix batteries with different chemistry types (for example, a zinc battery with an alkaline battery). **DO NOT** mix new and used batteries. **DO NOT** leave batteries installed in the product when not in use for long periods. Always remove old, weak or worn-out batteries promptly and recycle or dispose of them in accordance with local and national regulations.

Warning

This product is water-resistant, not waterproof. Avoid prolonged exposure to wet environments, such as rain, mist, dew, etc. In other words, you can take it out, just don't leave it out.

PAIRING THE SPEAKER SYSTEM

Adjusting the Transmitter

1. Turn on your audio source (for example, A/V receiver, MP3 player, stereo, etc.) and play music at a normal listening volume.
2. Set the channel select switch on the back of the transmitter to one of the transmitter's three broadcast frequencies: 1, 2 or 3. If you experience poor reception or interference, try choosing a different frequency by moving the channel select switch to another position.

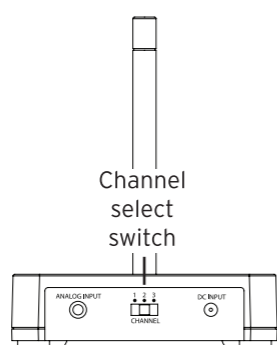

When the transmitter is receiving an audio signal and is ready, the POWER indicator on the transmitter's front panel turns solid blue.

Note

If the POWER indicator on the transmitter does not turn blue, please check the following:

- Confirm the transmitter AC power adapter is securely connected.
- Confirm the cable from the transmitter is securely connected to the audio source output (MP3 player, A/V receiver, etc.).
- Confirm the audio source is playing audio and is turned up.

Tuning the Speaker

1. Press and hold the On/Off/Volume/Tuning button on the front of the speaker until the Standby/Tuned indicator turns red. This indicator light stays red while the speaker is tuning to the transmitter. The indicator light turns green when the speaker is tuned to the transmitter—you should hear sound coming from the speaker now.

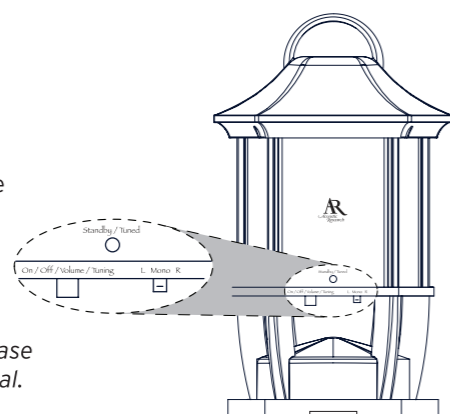

Note: If the speaker is not tuned or if the transmitter is not connected properly, the indicator light will stay red. If this occurs, please see the troubleshooting section of this manual.

2. Turn the On/Off/Volume/Tuning knob to adjust the volume on the speaker as desired.
3. Set up the speaker for mono or stereo operation using the switch on the front of the AW827 speaker.
 - a) Monaural operation: The monaural mode (mono) is recommended when using a single AW827 by itself. For monaural operation, set the L/M/R switch to "Mono."
 - b) Stereo operation: You need an additional AW827 speaker for the stereo option. Set the L/M/R switch to "L" on the speaker located to the left from the listener, and set the other speaker to the "R" position.

Notes:

The speaker automatically retunes if it loses the transmitter's signal. You can also press the On/Off/Volume/Tuning button on the front of the speaker to retune the speaker at any time. The transmitter turns off automatically if there is no audio signal present for a prolonged period. Interference in the form of static and/or distortion can sometimes be heard. If this occurs, confirm the transmitter/speaker adjustments and indicators. If the problem persists, refer to the Troubleshooting section of this manual.

Mounting the AW827 to a Post-Top (Optional)

This package includes a post-top mount plate that lets you safely mount the AW827 on top of a standard 4" x 4" post. The post-top mount plate has an lock and release mechanism that makes it easy to take the speaker off the post and put it back on whenever you want.

To mount the post-top mount plate: Use two flat-head wood screws (not included) to secure the post-top mount plate to the top of a 4" x 4" post as shown.

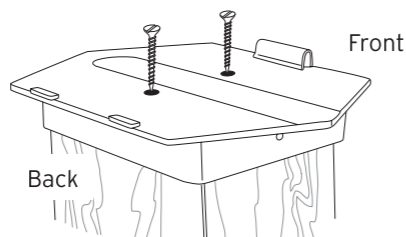

To lock the speaker to the post-top mount plate:

Line up the back of the speaker with the two tabs on the back of the post-top mount plate. Tilt the speaker backward slightly and lower the two slots on the speaker back onto the tabs on the post-top mount plate. Push the front of the speaker onto the post-top mount plate to lock it into place.

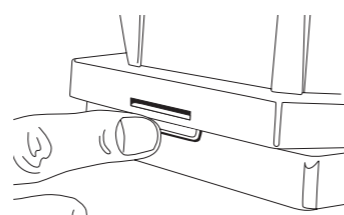
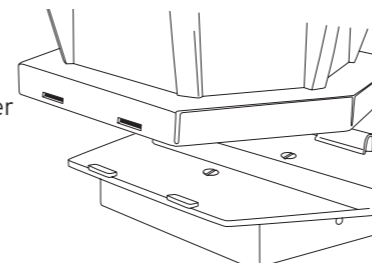

To release the speaker from the post-top mount plate: Press in on the latch on the front of the post-top mount plate. Lift the speaker up and backward gently until it unlatches from the post-top mount plate.

TURNING THE SPEAKER OFF

1. Press and hold the On/Off/Volume/Tuning button on the front of the speaker to turn the speaker off.
2. Confirm that the speaker is off by verifying that the indicator light on the speaker's front panel is no longer illuminated.

MORE HELPFUL INFORMATION

About Fixed-Level Audio Outputs

A fixed-level, or line-level, audio output is considered ideal since it provides an audio signal unchanged by adjustments to the audio source volume control.

Hint: Fixed-level audio outputs from stereo receivers/amps will typically be designated as Tape (or Record) outputs or DVR/DVD-R audio output connections.

Fixed-level outputs from TVs are usually marked as 'Constant,' 'Fixed,' or 'Select.' If they are not marked as such, they are probably variable outputs (see "About Variable-Level Audio Outputs" on the next page). Outputs from DVD players are almost always fixed.

Hint: When connecting to the audio outputs of a DVD player, remember that the DVD player must be showing a TV channel for sound to be produced.

About Variable-Level Audio Outputs:

A variable-level output, such as a headphone jack or certain RCA-type outputs, provides an audio signal that changes with the volume level set on the audio source. As the volume of the audio source is adjusted up and down, so is the audio signal strength sent to the transmitter. This can affect the quality of sound generated by the speaker, and may require an adjustment of the volume level of the audio source to produce a signal strong enough for the transmitter.

Hint: On most bookshelf-type or compact stereo systems, inserting a headphone plug into the headphone jack results in automatic cutoff of the regular, or hard-wired speakers.

Hint: Most TVs, regardless of age or price, have variable outputs. If you are unsure which of your TV audio outputs is fixed, refer to the TV instruction manual. Some TVs have outputs that can switch between variable and fixed. When given a choice, fixed is always recommended.

TROUBLESHOOTING

The following troubleshooting guide takes you through some of the more common problems associated with the installation and/or operation of a wireless system. If the problem persists, please call toll-free at 1-800-732-6866 or visit www.araccessories.com.

Issue:	Cause and solution:
No sound	<ul style="list-style-type: none"> • Check that the transmitter AC power adapter is fully inserted into the wall outlet and the power cord from the AC adapter is firmly connected to the transmitter power input jack. • Confirm that the speaker is turned on and tuned to the transmitter—the indicator light on the front of the speaker should be green. • Make sure the speaker's batteries are fresh and inserted with correct polarity (+, -). Replace if necessary. • Check that the audio source component (stereo, MP3 player, etc.) is turned on and transmitting sound as it normally should. • Make sure the volume on your audio source is turned up. • Check that the speaker volume is turned up. • If you are using a Tape 2 Monitor output from your receiver/amp as the audio output, check that you have pressed the Tape Monitor/Tape 2 button on the front of the receiver. This will turn on the Tape 2 outputs, which may not have been active.

Issue:	Cause and solution:
No sound/distortion/static	<ul style="list-style-type: none"> • Make sure the speaker's batteries are fresh and inserted with correct polarity (+, -). Replace if necessary. • Check that the speaker's indicator light is green. • Change the position of the channel select switch (1, 2 or 3) to change the operating frequency. Then press the speaker's On/Off/Volume/Tuning button to make the speaker retune. • Change the location of the transmitter. Place it as high and away from obstructions as possible. Avoid placing the transmitter directly on top of or behind a TV. • Move the transmitter and speaker closer together. Sending the signal through certain materials, such as glass, tile, and metal, can decrease the effective transmitting distance of the system.

SPECIFICATIONS

Transmitter

- Omni-directional 900MHz broadcast
- Effective transmitting range: up to 150 ft. (45m)*
- Phase-locked loop circuitry (PLL)
- 3 selectable broadcast frequencies
- Stereo audio input

*Maximum range; results may vary according to environment.

FCC Statement

This equipment has been tested and found to comply with the limits for a Class B digital device, pursuant to part 15 of the FCC Rules. These limits are designed to provide reasonable protection against harmful interference in a residential installation. This equipment generates, uses, and can radiate radio frequency energy and, if not installed and used in accordance with the instructions, may cause harmful interference to radio communication. However, there is no guarantee that interference will not occur in a particular installation. If this equipment does cause harmful interference to radio or television reception, which can be determined by turning the equipment off and on, the user is encouraged to try to correct the interference by one or more of the following measures:

- Reorient or relocate the receiving antenna.
- Increase the separation between the equipment and receiver.
- Connect the equipment into an outlet on a circuit different from that to which the receiver is connected.
- Consult the dealer or an experienced radio/TV technician for help.

FCC Regulations state that unauthorized changes or modifications to this equipment may void the user's authority to operate it.

Industry Canada Regulatory Information

Operation is subject to the following two conditions: (1) this device may not cause harmful interference and (2) this device must accept any interference received, including interference that may cause undesired operation. The user is cautioned that this device should be used only as specified within this manual to meet RF exposure requirements. Use of this device in a manner inconsistent with this manual could lead to excessive RF exposure conditions.

This Class B digital apparatus complies with Canadian ICES-003.

12 MONTH LIMITED WARRANTY

Audiovox Electronics Corporation (the "Company") warrants to the original retail purchaser of this product that should this product or any part thereof, under normal use and conditions, be proven defective in material or workmanship within 12 months from the date of original purchase, such defect(s) will be repaired or replaced (at the Company's option) without charge for parts and repair labor. To obtain repair or replacement within the terms of this Warranty, the product along with any accessories included in the original packaging is to be delivered with proof of warranty coverage (e.g. dated bill of sale), specification of defect(s), transportation prepaid, to the Company at the address shown below. Do not return this product to the Retailer.

This Warranty is not transferable and does not cover product purchased, serviced or used outside the United States or Canada. The warranty does not extend to the elimination of externally generated static or noise, to costs incurred for the installation, removal or reinstallation of the product.

The warranty does not apply to any product or part thereof which, in the opinion of the company, has suffered or been damaged through alteration, improper installation, mishandling, misuse, neglect, accident or exposure to moisture. This warranty does not apply to damage caused by an AC adapter not provided with the product, or by leaving non-rechargeable batteries in the product while plugged into an AC outlet.

THE EXTENT OF THE COMPANY'S LIABILITY UNDER THIS WARRANTY IS LIMITED TO THE REPAIR OR REPLACEMENT PROVIDED ABOVE AND, IN NO EVENT, SHALL THE COMPANY'S LIABILITY EXCEED THE PURCHASE PRICE PAID BY PURCHASER FOR THE PRODUCT.

This Warranty is in lieu of all other express warranties or liabilities. ANY IMPLIED WARRANTIES, INCLUDING ANY IMPLIED WARRANTY OF MERCHANTABILITY OR FITNESS FOR A PARTICULAR PURPOSE, SHALL BE LIMITED TO DURATION OF THIS WARRANTY. ANY ACTION FOR BREACH OF ANY WARRANTY HEREUNDER, INCLUDING ANY IMPLIED WARRANTY, MUST BE BROUGHT WITHIN A PERIOD OF 24 MONTHS FROM THE DATE OF ORIGINAL PURCHASE. IN NO CASE SHALL THE COMPANY BE LIABLE FOR ANY CONSEQUENTIAL OR INCIDENTAL DAMAGES WHATSOEVER. No person or representative is authorized to assume for the Company any liability other than expressed herein in connection with the sale of this product.

Some states/provinces do not allow limitations on how long an implied warranty lasts or the exclusion or limitation of incidental or consequential damage so the above limitations or exclusions may not apply to you. This Warranty gives you specific legal rights and you may also have other rights which vary from state/province to state/province.

U.S.A.: Audiovox Electronics Corp., 150 Marcus Blvd., Hauppauge, New York 11788

CANADA: Audiovox Return Center, c/o Genco, 6685 Kennedy Road, Unit #3 Door 16, Mississauga Ontario L5T 3A5

Trademark(s) © Registered

www.araccessories.com

MADE IN CHINA

AW827 US IB 01
40-01AW827-RF-00-XY