

ATOMIC

Quick

Set-Up Guide

AW822 (900MHz) PLL

Outdoor Speaker

Congratulations on the purchase of AW822 (900MHz) PLL (Phase Locked Loop) Wireless Stereo Speaker!

Table of Contents

- I. Location of functions
- II. Connecting the speaker system
- III. Adjusting the transmitter
- IV. Tuning the speaker
- V. Turning the speaker off
- VI. Recharging the batteries
- VII. Troubleshooting
- VIII. Specifications & Features

I. Location of Functions

Speaker Front View:

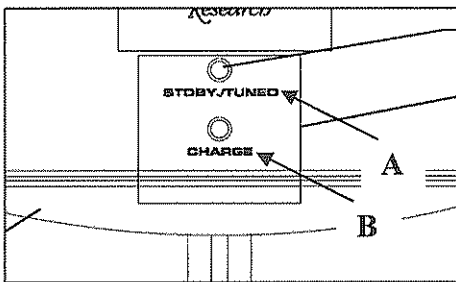

- A. Standby (Red)/tuned (Green) indicator light
- B. Charging indicator light (Red)

Speaker Side View:

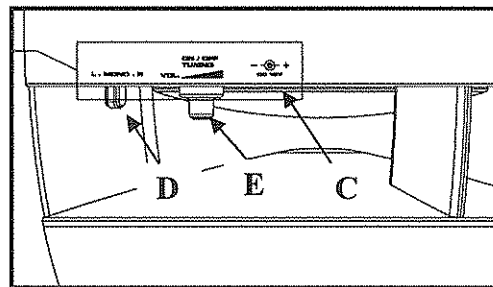

- C. Speaker power input jack
- D. Left/mono/right switch
- E. Power/auto tune/volume control

Speaker Top View:

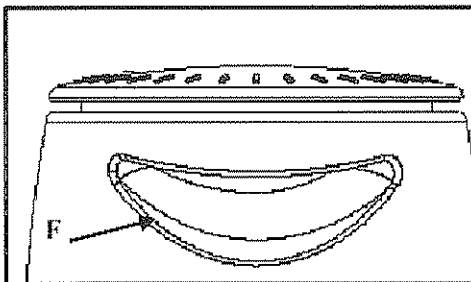

- F. Carrying handle

Speaker Bottom View:

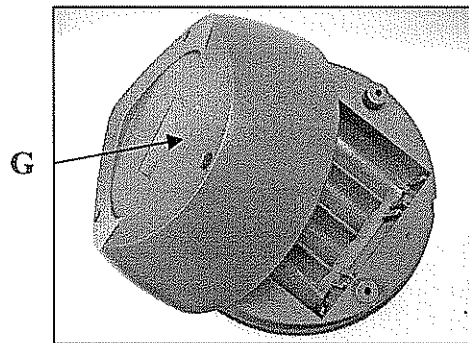

- G. Battery compartment cover

Transmitter Front View:

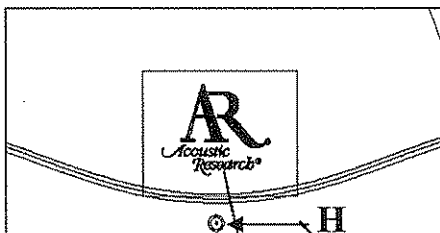

- H. ON = Transmit on (Green)

Transmitter Back View:

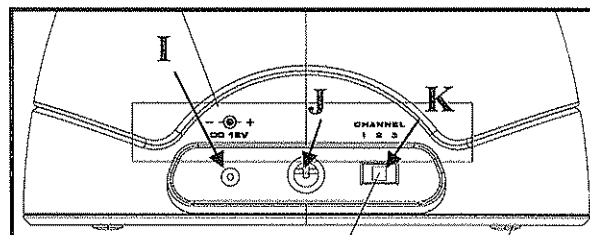

- I. Transmitter power input jack
- J. Audio input cable (Built in)
- K. Channel select switch

Accessories:

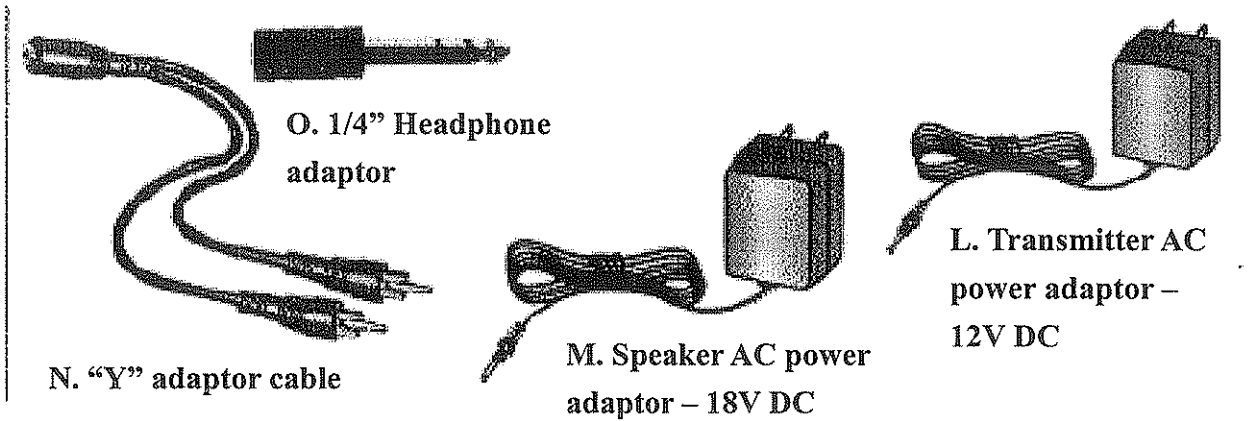

II. Connecting the Speaker System:

I. Powering the Transmitter

Connect the small, round plug from the transmitter AC power adaptor (L) to the transmitter power input jack (I) and plug the other end of the transmitter AC power adapter (L) into any standard 120V AC wall outlet.

Note: Be sure to use the AC power adapter rated 12V DC 100 mA.

Note: There is no transmitter ON/OFF switch. The transmitter is designed to be left plugged in and powered at all times.

If you will not be using the AW822 for an extended period of time, you may wish to unplug the transmitter AC power adapter.

II. Connecting to an Audio Source:

i. Connecting to an A/V Receiver:

1. Connect the included "Y" adapter cable (N) to the 3.5mm mini plug cable coming out of the transmitter.
2. Connect the RCA-type left (white) and right (red) audio plugs on the "Y" adapter cable to the corresponding left and right audio outputs of your A/V receiver, amp or other audio source.

ii. Connecting to a TV:

1. Connect the included "Y" adapter cable (N) to the 3.5mm mini plug cable coming out of the transmitter.
2. Connect the RCA-type left (white) and right (red) audio plugs on the "Y" adapter cable to the corresponding left and right audio outputs on the TV.

iii. Connecting to a Stereo or a Computer:

Plug the cable coming out of the transmitter into the headphone output of your stereo or the audio output jack on your computer. Use the included 1/4" headphone adapter (O) to convert the 3.5mm plug to a 1/4" plug as needed.

Warning: This product is designed to work with line level outputs or headphone outputs only. **DO NOT** connect it directly to speaker outputs as it will permanently damage the transmitter.

III. Powering the Speaker

There are two options to power your wireless speaker:

i. AC Power Adapter:

1. Turn the speaker volume down by rotating the power/auto tune/volume control (E) on the side of the speaker all the way to the left.
2. Insert the small, round plug from the speaker AC power adapter (M) into the speaker power input jack (C).
3. Plug the other end of the speaker AC power adapter into any standard 120V AC wall outlet.

Note: Be sure to use the speaker AC power adapter rated 18V DC 700 mA.

Warning: This product is water resistant, not waterproof. To avoid electrical shock, it should be used with caution near water sources if powered with the AC adapter. Never submerge in water.

ii. C-cell Batteries:

1. Turn the speaker volume down by rotating the power/auto tune/volume control (E) on the side of the speaker all the way to the left.
2. Remove the battery compartment cover (G) on the bottom of the speaker.
3. Insert eight (8) C-cell batteries (not included) into the speaker following the polarity (“+” and “-”) as diagrammed inside the battery compartment.

Note: Place the rubber cap in the speaker power input jack (C) when using batteries.

Important:

If you are using rechargeable NiMH or NiCd batteries, the batteries will charge when the speaker is powered with AC power adapter (the “Charging indicator light” will illuminate red).

Please do not power the speaker with the AC power adapter if you installed alkaline or other non-rechargeable batteries—this could cause the batteries to leak. Do not mix batteries with different chemistry types (for example, a zinc battery with an alkaline battery). Do not mix new and used batteries. Do not leave batteries installed in the product when not in use for long periods

III. Adjusting the Transmitter

1. Turn ON your audio source (i.e., A/V receiver, TV, stereo, etc.) and play music at a normal listening volume.
2. Set the channel select switch (K) on the back of the transmitter to 1, 2 or 3. The transmitter provides three different broadcasting frequencies. In the event that you experience poor reception or interference, try choosing a different frequency by moving the channel select switch to another position.
3. If the transmitter gets the signal from the audio source and ready, the “On” (H) on the front of the transmitter will turn green.

Note: If the light does not on, please check the following:

- Confirm the transmitter AC power adapter (L) is securely connected.
- Confirm the cable from the transmitter is securely connected to the audio source output (TV, A/V receiver,

etc.).

IV. Tuning the Speaker

1. Press the Power/auto tune/volume control (E) up to turn the speaker ON. The standby/tuned indicator light (A) will illuminate red until the speaker is tuned to the transmitter and then the light will illuminate green, indicating that the speaker is tuned properly. You should hear sound coming from the speaker now.

Note: If the speaker is not tuned or if the transmitter is not connected properly, the standby/tuned indicator light (A) will continue to illuminate red. If this occurs, please see the troubleshooting section of this manual.

2. Adjust the volume on the speaker as desired.

3. Mono/stereo operation set up:

a) Monaural operation: The monaural mode (MONO) is recommended when using a single speaker or if using more than one speaker in different locations.

For monaural operation, set the left/mono/right switch (D) to “MONO” on speaker.

b) Stereo operation: You will need an additional AW822 speaker in order to utilize the stereo option.

For stereo operation, set the left/mono/right switch (D) to “L” on the speaker located to the left from the listener, and set the other speaker to the “R” position.

4. The speaker will automatically retune if it loses the signal from the transmitter. However, you can also push the Power/auto tune/volume control (E) to retune the speaker at anytime. While the speaker is tuning, the standby/tuned indicator light (A) will turn red. After locking onto the transmitter signal, the green standby/tuned indicator light (A) will come back on.

5. The transmitter has auto-cut-off function. When there is no audio signal for a prolonged period, the power of the transmitter will be automatically cut off.

Note: Interference in the form of static and/or distortion can sometimes be heard. If this occurs, confirm the transmitter/speaker adjustments and indicators. If the problem persists, refer to the Troubleshooting section of this manual.

V. Turning the Speaker Off

1. Press and hold the Power/auto tune/volume (E) up to turn the speaker OFF. You will need to hold the control for about 1.5 seconds for the speaker to turn off.

2. Confirm that the speaker is off by verifying that the green standby/tuned indicator light (A) is no longer illuminated.

VI. Recharging the Batteries

The speaker will automatically charge the rechargeable batteries (NiMH or NiCd) only when the batteries are installed and the speaker is plugged in with the AC power adapter. Charging indicator light (B) will light up

red to confirm that the batteries are being charged.

Warning: DO NOT attempt to charge any other batteries except those specified above.

VII. Troubleshooting

The following troubleshooting guide takes you through some of the more common problems associated with the installation and/or operation of a wireless system.

Issue:	Cause and solution:
No Sound	<ul style="list-style-type: none">• Check that the transmitter AC power adapter is fully inserted into the wall outlet and the power cord from the AC adapter is firmly connected to the transmitter power input jack.• Confirm that the speaker is turned ON and tuned to the transmitter – the standby/tuned indicator light (A) on the front of the speaker should illuminate green.• Confirm that the speaker AC power adapter is fully inserted into the wall outlet and the power cord on the AC power adapter is firmly connected to the speaker power input jack. <p>or</p> <ul style="list-style-type: none">• Check that the C-cell batteries are fresh and inserted with correct polarity (+, -).• Check that the audio source component (stereo, TV, etc.) is turned on and transmitting sound as it normally should.• Check that the speaker volume is turned up.• If you are using a Tape 2 Monitor output from your receiver/amp as the audio output, check that you have pressed the Tape Monitor/Tape 2 button on the front of the receiver. This will turn on the Tape 2 outputs, which may not have been active.
Issue:	Cause and solution:
No sound/ distortion/ static	<ul style="list-style-type: none">• When using battery power, make sure the batteries are fresh and replace if necessary.• Check that the speaker standby/tuned indicator light (A) is illuminated green. <p>or</p> <ul style="list-style-type: none">• Change the position of the channel select switch (1, 2 or 3) to change the operating frequency. The speaker will detect the loss of signal and retune automatically. However, you can also press the Power/auto tune/volume control (E) up once to make the speaker retune.• Change the location of the transmitter. Place it as high and away from obstructions as possible. Avoid placing the transmitter directly on top of or behind a TV.• Move the transmitter and speaker closer together. Sending the signal through certain materials, such as glass, tile, and metal, can decrease the effective transmitting distance of the system.

V III. Specifications & Features

Transmitter

Omnidirectional

PLL (Phase lock loop)

Effective transmitting range: up to 80 meters*

3 selectable broadcast frequencies (between 912 and 914 MHz)

Stereo audio input with 3.5mm stereo mini plug (1/4"headphone adapter and "Y" cable included)

UL-list AC power adapter

Speakers

Push-button, auto-lock tuning

Two –way acoustic suspension design

1" dome tweeter; 5" woofer

Integrated power/auto tune/volume control

Left/mono/right switch

Frequency response: 20 Hz – 20kHz

Signal- to- noise ratio > 60dB

* Maximum range; results may vary according to environment.

Warning: Changes or modifications to this unit not expressly approved by the party responsible for compliance could void the user's authority to operate the equipment.

NOTE: This equipment has been tested and found to comply with the limits for a Class B digital device, pursuant to Part 15 of the FCC Rules. These limits are designed to provide reasonable protection against harmful interference in a residential installation. This equipment generates uses and can radiate radio frequency energy and, if not installed and used in accordance with the instructions, may cause harmful interference to radio communications.

However, there is no guarantee that interference will not occur in a particular installation. If this equipment does cause harmful interference to radio or television reception, which can be determined by turning the equipment off and on, the user is encouraged to try to correct the interference by one or more of the following measures:

- Reorient or relocate the receiving antenna.
- Increase the separation between the equipment and receiver.
- Connect the equipment into an outlet on a circuit different from that to which the receiver is needed.
- Consult the dealer or an experienced radio/TV technician for help.