

Wireless Digital Video Recorder

Installation and Operating Instructions

Model: WDVR-3AX

Version 1.1

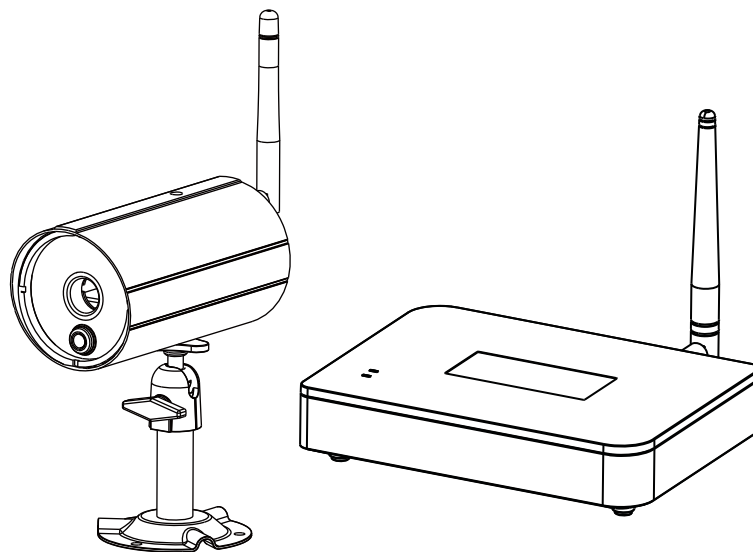

PLEASE READ THESE INSTRUCTIONS CAREFULLY BEFORE USING THIS PRODUCT
AND KEEP THIS MANUAL FOR FUTURE REFERENCE.











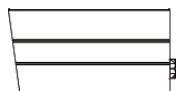



The state of art WIRELESS DIGITAL VIDEO RECORDER is capable of deliver high quality video to your smart-mobile device(s), which would require higher internet bandwidth. Due to your local internet environment condition, your mobile device(s) may display black-screen or temporary disconnect to the WDVR.

- * Make sure the WDVR is operating with sufficient internet bandwidth, **1.5Mbps (upload speed) per camera is suggested.**
- * For best performance, **the smart-mobile device(s) need to be on Wi-Fi or 4G mobile network** in order to receive maximum download speed.
- * **When the internet transmission is low**, your WDVR APP will automatically switch to Relay Mode:
 - By adjusting image quality to **“low”** in the camera setting section may improve the WDVR APP performance.
- * **Your internet bandwidth is limited.** For best performance, try to avoid more than two users connecting to the WDVR simultaneously.
- * Make sure your smart-mobile device(s) is equipped with up-to-date technology, **1.5GHz dual core processor or equivalent is suggested.**
- * Please make sure the memory card used is **CLASS10** rated.

CONTENTS

KIT CONTENT	2
INTRODUCTION	3
IMPORTANT SAFETY PRECAUTIONS.....	3
KNOWING YOUR DEVICES	5
WIRELESS DIGITAL RECEIVER CONSOLE	6
WIRELESS DIGITAL OUTDOOR PIR CAMERA.....	8
INSTALLING YOUR DEVICES	10
CONNECTING THE WIRELESS DVR TO YOUR TV/MONITOR	10
INSTALLING YOUR CAMERA	11
CONNECTING THE MOUSE	13
CONNECTING TO TV.....	14
CONNECTING THE ETHERNET	15
INSERT MEMORY CARD	16
INSTALL/EXPAND THE HARD DISK DRIVE (optional)	17
BASIC OPERATION	19
QUICK SELECT MENU	19
LIVE VIEW WITH QUAD DISPLAY	20
LIVE VIEW WITH SMART-QUAD DISPLAY	21
LIVE VIEW WITH DYNAMIC DISPLAY	21
MAIN MENU	21
RECORDED VIDEO FILE PLAYBACK	21
AUTO SCAN.....	21
REMOTE SURVEILLANCE SETUP	22
KNOWING THE MAIN MENU.....	23
ADVANCED SETTINGS.....	25
CAMERA SETUP.....	25
RECORDER SETUP.....	27
EVENT LIST	32
SYSTEM SETUP	33
STORAGE SETUP.....	35
TROUBLE SHOOTING	37
PRODUCT SPECIFICATION	39
APPENDIX 1: COMPATIBLE LIST.....	40
APPENDIX 2: RECORDING CAPACITY	41

KIT CONTENT

<p>Digital Wireless Outdoor IR Camera</p>  <p>x 2</p>	<p>Digital Wireless Receiver Console</p>  <p>x 1</p>	<p>Camera / Receiver Antenna</p>  <p>x 3</p>
<p>Camera Stand</p>  <p>x 2</p>	<p>Screw Pack</p> <p>For Camera  x 2</p> <p>For HDD Metric Screw  x 1</p> <p>Unified Screw  x 1</p>	<p>Camera / Receiver Adaptor</p> <p>Camera power adapter-5V/1A  x 2</p> <p>WDVR power adapter-12V/3A  x 1</p>
<p>Mouse</p>  <p>x 1</p>	<p>Ethernet Cable</p>  <p>x 1</p>	<p>HDMI Cable</p>  <p>x 1</p>
<p>Owner Manual CD</p>  <p>x 1</p>	<p>HDD (optional)</p>  <p>x 1</p>	<p>Memory Card (optional)</p>  <p>x 1</p>

Minimum System Requirement for DVR:

*For Networking:

- DHCP enabled router
- 1.5Mbps or above upload bandwidth (both home and mobile device).
- iPhone4S / Mini iPad or above.
- Android 1.2G / 1.5G dual core or above.

*For Recording:

- Max 2TB HDD supported (max. 5V/1A USB power supported).

*For Display:

- For best performance, only use HDMI cable provided.

INTRODUCTION

IMPORTANT SAFETY PRECAUTIONS

Damages caused by non-compliance with this operating manual will void the warranty! We will not assume any liability for damages to items or persons caused by improper handling or non-compliance with the safety notices! Any warranty claim will be null and void in such cases.

1. Do not drop, puncture or disassemble the camera; otherwise the warranty will be voided.
2. Avoid all contact with water, and dry hands before using.
3. Never tug on the power cords. Use the plug to unplug it from the wall outlet.
4. Do not expose the camera to high temperature or leave it in direct sunlight. Doing so may damage the camera or cause camera temporary malfunction.
5. Use the devices with care. Avoid pressing hard on the camera body.
6. For your own safety, avoid using the camera or power off the camera when there is a storm or lightning.
7. Remove the power adapter during long periods between usages.
8. Use only the accessories and power adapters supplied by the manufacturer.
9. To meet the regulations pertaining to parental responsibility, keep the devices out of the reach of infants.
10. Check power cables, do not get crushed or damaged by sharp edges whenever the devices are in operation.



FCC Compliance Statement: This device complies with Part 15 of the FCC rules. Operation is subjected to the following two conditions: (1) this device may not cause harmful interference, and (2) this device must accept any interference received, including interference that may cause undesired operation.



Products with CE Marking comply with EMC Directive (2004/108/EC); Low Voltage Directive (73/23/EEC); R&TTE(1999/5/EC); ROHS Directive (2011/65/EU) issued by the Commission of the European Community. Compliance with these directives implies conformity to the following European Norms:
EMC: EN 301 489
LVD: EN 60950
Radio: EN 300 328

FCC/CE WARNING

This equipment has been tested and found to comply with limits for a Class B digital device, pursuant to Part 15 of the FCC rules and ETSI(EN) 300328. These limits are designed to provide reasonable protection against harmful interference in residential installations. This equipment generates, uses, and can radiate radio frequency energy, and if not installed and used in accordance with the instructions, may cause harmful interference to radio communications. However, there is no guarantee that interference will not occur in a particular installation. If this equipment does interference to radio or television equipment reception, which can be determined by turning the equipment off and on, the user is encouraged to try to correct the interference by one or more of the following measures:

- Reorient or relocate the receiving antenna.
- Move the equipment away from the receiver.
- Plug the equipment into an outlet on a circuit different from that to which the receiver is connected.
- Consult the dealer or an experienced radio/television technician for additional suggestions.

You are cautioned that any change or modifications to the equipment not expressly approved by the party responsible for compliance could void your authority to operate such equipment.

The distance between user and products should be no less than 20cm

DISPOSAL



If the camera system no longer functions or can no longer be repaired, it must be disposed of according to the valid statutory regulations.

Disposal of spent batteries/accumulators:

You are required by law (Battery Ordinance) to return all spent batteries and accumulators. Disposing of spent batteries/accumulators with common household waste is prohibited! Batteries/accumulators that contain hazardous substances are marked with the symbols on the side. These symbols indicate that it is prohibited to dispose of these batteries/accumulators in the household waste. The abbreviations for the respective heavy metals are: Cd=cadmium, Hg=mercury, Pb=lead. You can return spent batteries and accumulators that can no longer be charged to the designated collection points in your community, outlets or wherever batteries or accumulators are sold. Following these instructions will allow you to fulfill the legal requirements and contribute to the protection of our environment!



CAUTION

- This product is designed with built-in high sensitivity microphone. Please keep the camera away from the receiver (at least 3 to 5 meters in distance) to avoid continuous howling noise to occur, otherwise please adjust receiver volume to low if the location of camera(s) is near by the receiver.
- Do not insert or remove memory card and/or HDD (external/internal version) while the system is in operation. This may cause system to malfunction and/or damage the storage media. It is strongly recommended to format the memory card and/or HDD prior the initial operation of the system and periodically afterwards.

KNOWING YOUR DEVICES



BEFORE THE PRODUCT IS INSTALLED

Please read the operation manual carefully.

Please unpack all boxes carefully and identify that all the parts are present.

Make sure you use only the recommended power supplies. Damage caused to the camera or receiver by incorrect voltage or wiring is not covered by the warranty.

Cutting any cable will void the warranty.

Do not drop, pierce or dismantle the camera or receiver.

The Digital Wireless DVR System consists of a DVR unit, which can receive video and audio data from up to 4 Digital Wireless Cameras, and is able to store received data to the HDD. You are able to view the data in real-time, or at later time, also remote view via mobile device(s) with Internet connection, such as smartphone and table.

The Digital Wireless Camera(s) is able to wirelessly transfer compressed video and audio data in digital format which offers efficient, secure and 'Interference Free' wireless connection to the DVR unit.

The method of transferring audio and video is secure and private, and eliminates the need of running cable(s) between the receiver and the cameras, ensures quick and easy installation with minimum cost at the same time.

WIRELESS DIGITAL RECEIVER

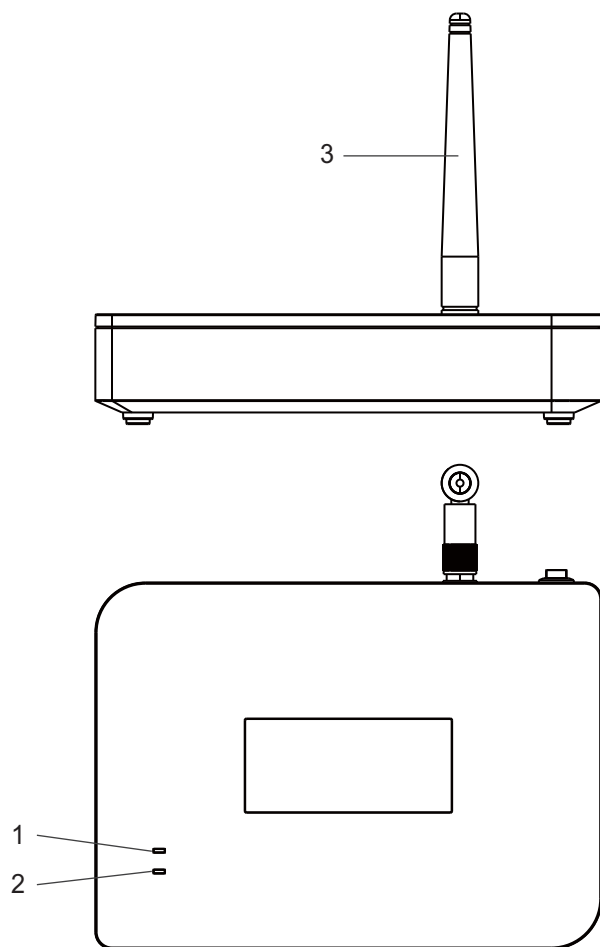

Item	Name	Function
1	Power Indicator	Indicate Power On/Off Status
2	Link Indicator	Indicate Wireless Data Transfer Status
3	Antenna	Transmit/Receive Digital Wireless Audio/Video Data

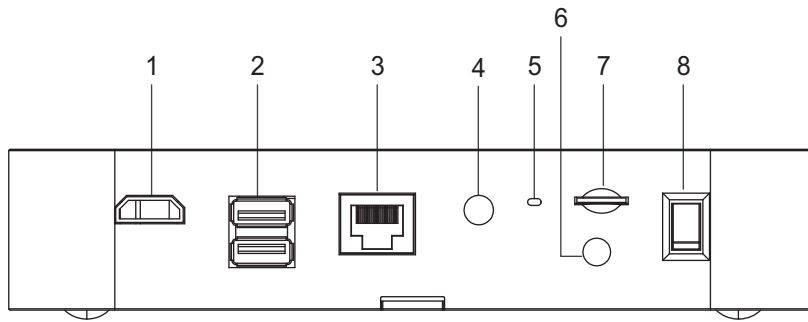

Item	Name	Function
1	HDMI Port	Video & Audio Output (TV)
2	USB Port	Mouse
3	RJ45 Port	Internet Connection (Router)
4	SMA Connector	Receiver Antenna Installation (Twist On)
5	Reset Button	Reset System
6	Power Input	DC 12V Adaptor
7	Micro Memory Card Slot	Micro Memory Card Insert Location
8	Power On/Off Switch	Power On/Off Digital Wireless Receiver Console

Note:

Connect the HDMI cable to TV before power on the Digital Wireless Receiver Console.
Please insert memory card before power on the Digital Wireless Receiver Console.

WIRELESS DIGITAL OUTDOOR PIR CAMERA

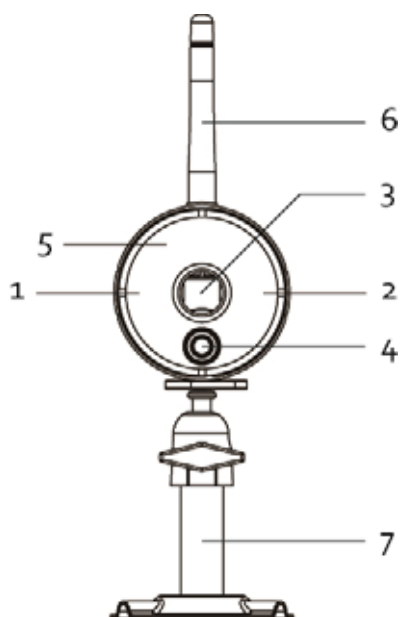

Item	Name	Function
1	Power Indicator	Indicate Power On/Off Status
2	Link Indicator	Indicate Wireless Data Transfer Status
3	Lens	Capture Image
4	PIR	Passive Infrared sensor for detecting heat emission from biomass (human, animals, etc.)
5	IR LEDs	Night View
6	Antenna	Transmit / Receive Digital Wireless Audio / Video Data
7	Camera Stand	Fasten Camera to Wall, Ceiling and/or Flat Surface

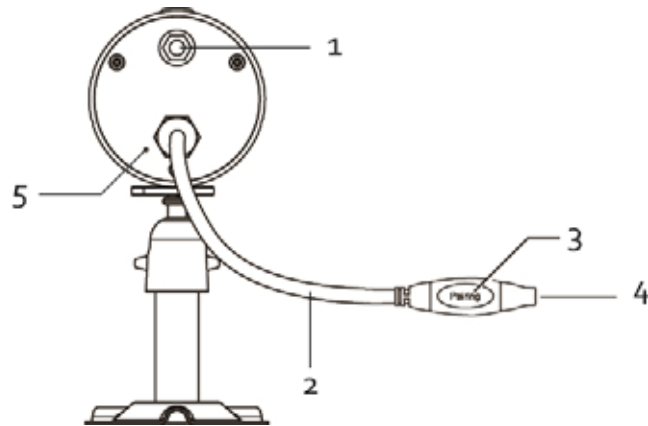

Item	Name	Function
1	SMA Connector	Camera Antenna Installation (Twist On)
2	Electric Cable	Conduct Power to Camera
3	Pairing Button	Connect Camera to Receiver
4	Power Input	DC 5V/1A Adaptor
5	Microphone	Capture Audio

INSTALLING YOUR DEVICES

CONNECTING THE WIRELESS DVR TO YOUR TV/MONITOR

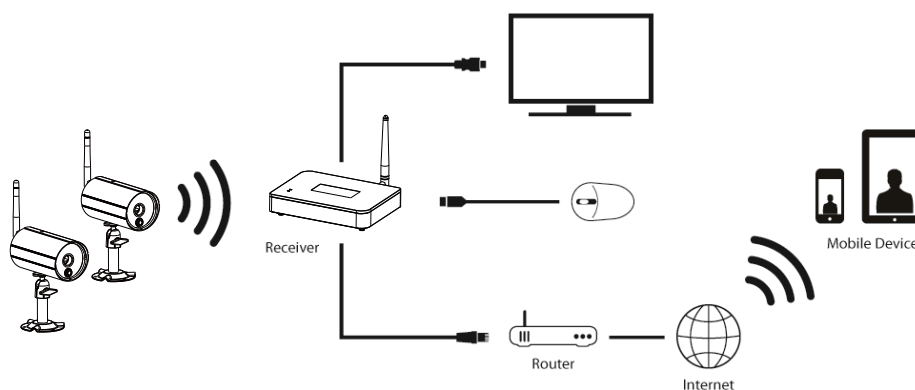

1. Connect the supplied receiver antenna and mouse to the back of the receiver.
2. Connect the supplied Ethernet cable from the receiver to router.
3. Connect the supplied HDMI cable from the receiver to HDMI connector on TV/monitor.
4. Insert memory card / connect HDD to receiver (if applicable).
5. Connect the supplied power adaptor on the receiver to power source (electric wall socket).
6. Power on the receiver, the Digital Wireless Receiver Console is now ready for use.
7. Turn on TV/monitor and switch to proper HDMI input source.

Note:

The HDMI interface automatically configure/adjust the audio output to proper format supported by TV/monitor.

Please use TV volume adjustment to adjust the audio level.

May need to reset TV input to pick up WDVR signal from HDMI.



THE WIRELESS INDICATION

When the DVR and camera are connected and have a good wireless signal, the Green LED indicator on the camera and the Green Signal LED on the DVR will light up.

INSTALLING YOUR CAMERA

1. Locate a suitable location to mount the camera.
2. Fix the camera stand to the wall using the supplied wall plugs and screws.

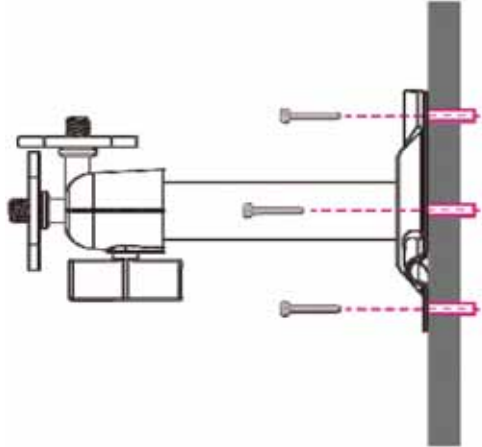

3. Loosen the thumb screw of the camera stand and secure the camera body to the bracket. Make sure the camera is in an upright position (relative to your viewing environment).

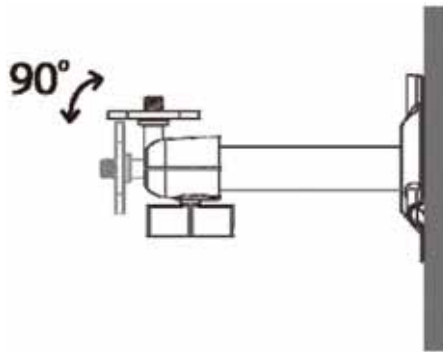

Screw on the Antenna to the rear of the camera.

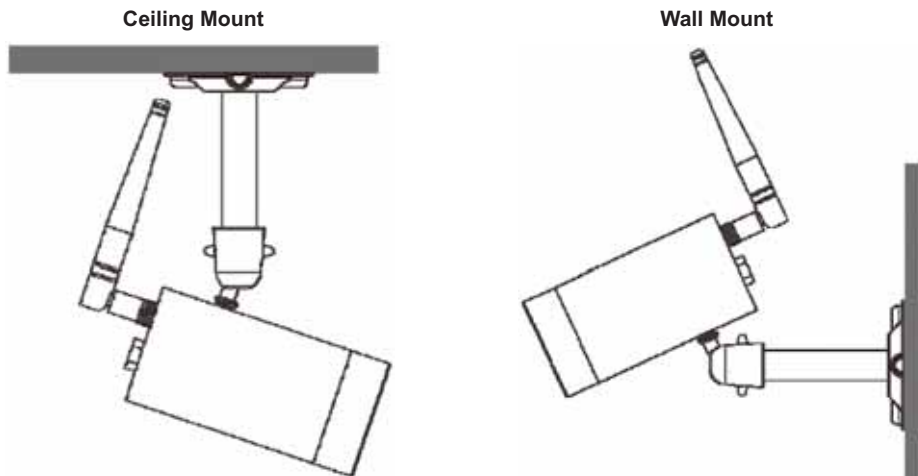

4. Connect the supplied power adaptor to the camera and the power source. The RED power LED will light up. The camera is now ready for use.
5. Pair the newly purchased additional camera(s) to DVR. The camera(s) came with the package purchased has already been paired to WDVR receiver.

CONNECTING THE MOUSE

The DVR supports USB mouse through the USB port on the rear panel.

The USB port is provided ONLY for USB mouse connection. Do not connect to HDD/USB Flash or PC/NB. If you want to use a wire/wireless mouse of your own, make sure the mouse is HID compatible.

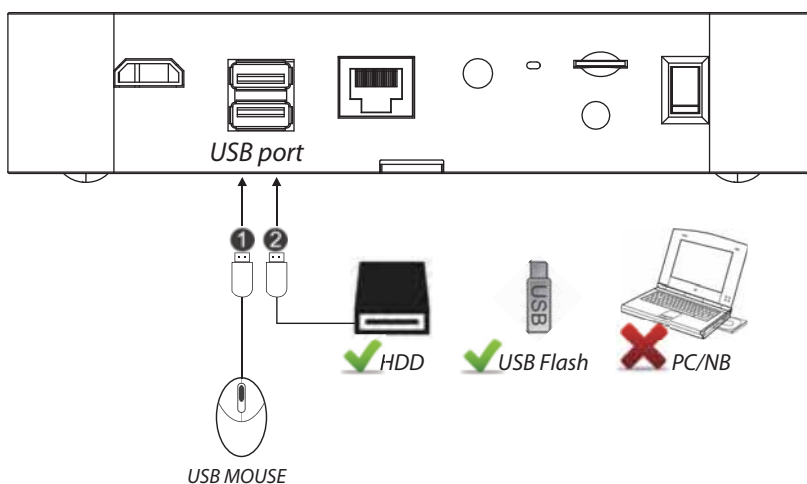

Note:

Do not connect the wireless DVR to a computer via the USB port. Besides, do not power up the DVR using the USB cable or attempt to connect your external HDD to the USB mouse connector. The USB port is designed for the USB mouse ONLY.

NOTICE

If the mouse is not detected, please

- Re-plug the mouse for several times
- Power off/on the machine again
- Check the batteries poles (if any)
- Check the remaining charge in the battery
- Change a mouse to try

CONNECTING TO TV

Use the HD connector and the HDMI cable provided with the package to connect WDVR to your TV.

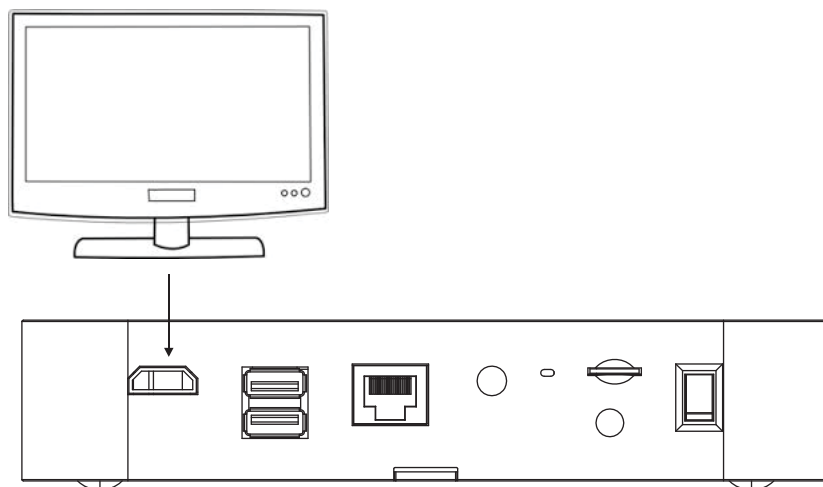

Note:

If you want to use a HDMI cable of your own, make sure the quality is good.
Performance and compatibility may vary depending on cables and TV brands.
Please use TV remote controller to adjust Audio/Alarm volume.
Please use TV remote controller to fine tune the camera color saturation/brightness/
sharpness, ect. Camera image performance may vary among TV brands.

*Make sure the TV supports 720P/50Hz

CONNECTING THE ETHERNET

Use the RJ45 connector and the Ethernet cable provided with the package to connect WDVR to internet.

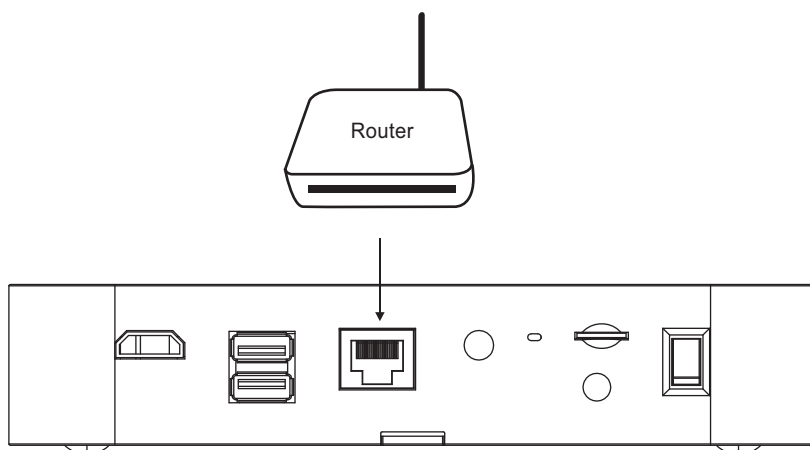

INSERT MEMORY CARD

The memory card slot provides an alternative storage for WDVR. You can use a memory card to store security video clip or copy/backup a video clip from HDD.

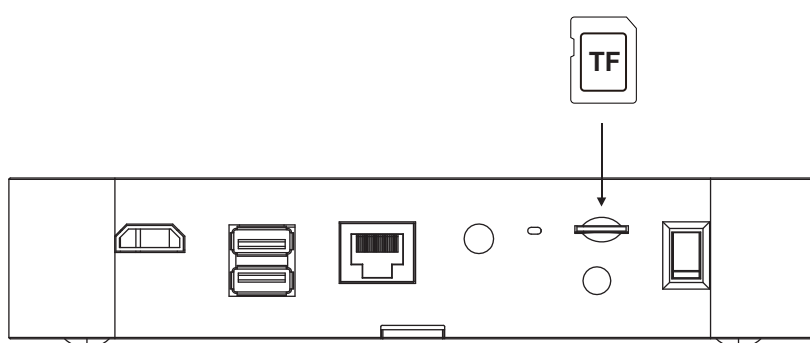

Suggested memory card:

- a. Sandisk 32GB/class-10
- b. Kingston 32GB/class-10
- c. Sony 32GB/class-10
- d. Samsung 32GB/class-10

Note:

Class10 memory card is suggested.

There may be compatibility issue among memory card brands, known incompatible memory card is Transcend 8GB/Class10.

INSTALL/EXPAND THE HARD DISK DRIVE (optional)

WDVR supports internal hard disk drive from 500GB to 2TB. If you need to install the hard disk or expand the hard disk capacity, please notice that

WDVR supports FAT32 format storage disk. Some storage disk may be formatted into other format (e.g. NTFS). You will need to prepare your disk following the steps below before you install the disk to WDVR.

You may use **DOS** Command Prompt to format your HDD or external USB HDD to **FAT32**, or you can simply format the disk using **Disk Management**.

1. Open a command prompt window by going to click **Start**, in the search box, type in [CMD], right click and choose [Run as administrator].

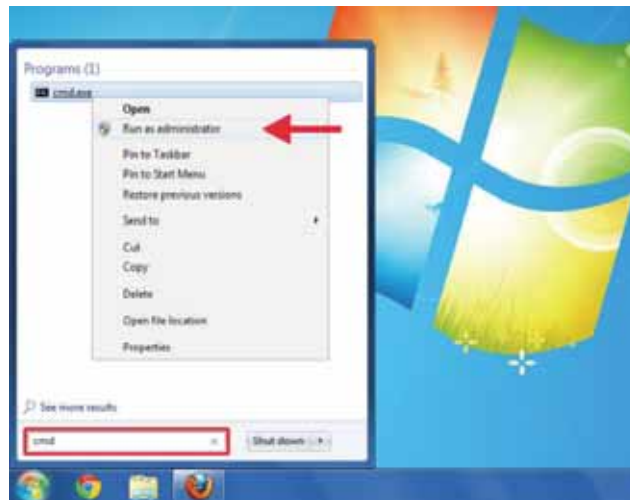

Or you can simply press and hold [Windows] key and [R] key (**⊞+R**), then the [Run] window will pop up, type in [CMD].

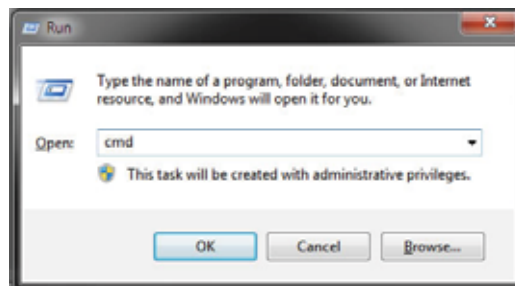

2. Type in **[format /FS:FAT32 F:]** at the prompt and press **Enter**.

*the **F:** is which partition you want to format.

Example : If you want to format your **partition G,**
you will need to type **format /FS:FAT32 G:**



```
C:\WINDOWS\system32\cmd.exe
Microsoft Windows XP [Version 5.1.2600]
(C) Copyright 1985-2001 Microsoft Corp.

C:\Documents and Settings\Administrator>format /FS:FAT32 F:
The type of the file system is NTFS.
The new file system is FAT32.

WARNING, ALL DATA ON NON-REMOVABLE DISK
DRIVE F: WILL BE LOST!
Proceed with Format (Y/N)? y
Verifying 953867M
```

3. Press **Y = Yes** or **N = No** to proceed or stop the formatting. Depending on the size of disk you want to format, it will take around 25 minutes to 40 minutes to complete the whole process.

Many HDD manufacturers also provide the official released method or tool to convert and/or format a 32GB+ large drive to FAT32, you may follow the steps and tool provided by your HDD manufacturer to prepare a proper storage drive for WDVR. Here are some examples:

For Seagate:

http://knowledge.seagate.com/articles/en_US/FAQ/200895en?language=en_US

For WD:

<http://support.wd.com/index.asp?lang=en>

At WD support webpage, search "How to format a WD external hard drive in exFAT or FAT32"

BASIC OPERATION

QUICK SELECT MENU







The DVR system is controlled through mouse operation.

Use the RIGHT mouse button to activate the QUICK SELECT menu.

Navigate the mouse cursor over the icon.

Use the LEFT mouse button to select the option.

Use any mouse button to exit the QUICK SELECT menu at any time.

Quick Select Menu Icon Image	Function	Left Mouse Button	Right Mouse Button
	Channel Select CH1/CH2/CH3/CH4	Select Channel	Exit Quick Select Menu
	Enter Main Menu	Enter System Setting	
	QUAD Display Select	Select QUAD Display	
	Smart-QUAD Display Select	Select Smart-QUAD Display	
	Single Channel Record/Stop Single Channel Record	Start/Stop Single Channel Record Function	
	All Channel Record/ Stop All Channel Record	Start/Stop All Channel Record Function	

LIVE VIEW WITH QUAD DISPLAY



During LIVE VIEW in QUAD DISPLAY mode, you can click on any channel for full screen display.

Left click (mouse) to exit full screen display.

Right click (mouse) to bring up QUICK SELECT MENU.

* The red "V" sign shows which channel is currently selected.

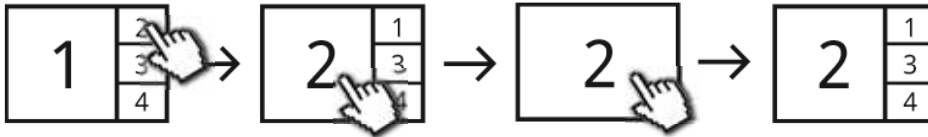

During LIVE VIEW in SMART-QUAD DISPLAY mode, you can click on any of the side display channels to allocate the image to the main display section of the SMART-QUAD DISPLAY.

Left click (mouse) the main display section for full screen display.

Left click (mouse) to exit full screen display.

Right click (mouse) to bring up QUICK SELECT MENU.

LIVE VIEW WITH DYNAMIC DISPLAY



You can choose to deactivate any or multiple channels in the CAMERA SETUP section of the MAIN MENU. The Wireless Digital Video Recorder will remove deactivated channel(s) from QUAD DISPLAY and SMART-QUAD DISPLAY.

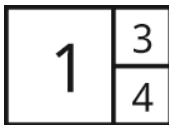

Turn CH2 off

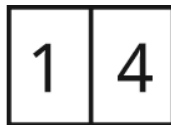

Turn CH2/CH3 off

Further, SMART-QUAD DISPLAY will automatically re-configure display for optimum viewing experience.

MAIN MENU

Please refer to "KNOWING THE MAIN MENU" section of manual for detail.

RECORDED VIDEO FILE PLAYBACK

Please refer to "EVENT LIST" section of manual for detail.

It is suggested to use VLC Media Player to playback recorded video file(s). It is free and can be downloaded at <http://www.videolan.org/vlc/>.

AUTO SCAN

When you are running multiple cameras, you can choose to display all available channels in sequence (5 or 10 seconds)

To setup AUTO SCAN function, go to SYSTEM SETUP in the MAIN MENU, select DISPLAY SETUP to choose preferred display method. You may choose to deactivate the channel(s) so the AUTO SCAN function can automatically skip the channel(s) deactivated.



NOTICE

System will automatically exit QUICK SELECT/MAIN menu after idling for 1 minute or longer.

REMOTE SURVEILLANCE SETUP

WDVR provide friendly and handy internet connection and mobile device accessibility.

Step 1. Connect WDVR to router (please refer to the "Connecting to Ethernet" chapter)

Step 2. Power up and turn on WDVR.

In the Live View mode, wait until  logo turns . This means WDVR is now ready for internet connection. The process takes around 30 seconds.

Step 3. Download free APP "WDVR Cam" from APP store/Google Play.

Step 4. Launch the APP. Tap "Device" or "Device list" → tap "New" or "+" icon → "Scan QR code" icon.

Step 5. Find the QR code sticker at the back of WDVR. If you have correctly installed the WDVR, you can also scan the QR code on TV (menu → "storage setup" → "system info").

Note: Suggest to use the Barcode Scanner" to scan the QR code.

Step 6. Enter the default password "123456". Give your remote access a name and tap "save" to exit.

Step 7. Tap the device from the list, then tap "play" to connect. It will take a few seconds to access the remote video, depending on the network environment.

Note:

WDVR allows max 3 remote viewer to access the system. The 4th connection will be rejected. When local user is operating setup menu. Remote user will be temporary reject to access WDVR until local user leave menu. WDVR requires 1.5Mbps connection bandwidth per connection to receive best viewing quality/streaming. It is suggested to set camera resolution and quality to "Low" in order to receive streaming remote view if the bandwidth is below 1.5Mbps.

KNOWING THE MAIN MENU







	Icon	Left Mouse Button	Available Options
1		CAMERA SETUP	Camera Pairing Camera Activation Resolution Quality
2		RECORDER SETUP	Record Schedule Motion Sensitivity Motion Area Detection
3		EVENT LIST	Event List Calendar
4		SYSTEM SETUP	Date and Time Language Display Setup Idle Display Setup Power Saving
5		STORAGE SETUP	Storage Status Storage Formatting Network Setup Network Info

The WDVR system also allows you to remotely access the live video from your iPhone, iPad or Android mobile device. Free APP is available through the APP Store/Google Play.

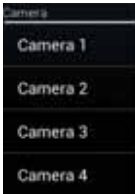
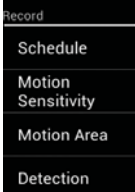
APP Name: **WDVR Cam**

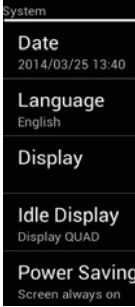



APP Main Screen:



	Section	APP main screen
1	CAMERA SETUP	
2	RECORDER SETUP	
3	EVENT LIST	
4	SYSTEM SETUP	
5	STORAGE SETUP	

ADVANCED SETTINGS

CAMERA SETUP



	Icon	Main Function	Setup Description
1		CAMERA PAIRING	<p>Pairing the camera to WDVR is necessary when Purchase of additional camera(s). Change original camera channel.</p> <p>To pair the camera to DVR:</p> <ol style="list-style-type: none"> 1. Enter Main Menu > Camera Setup > Select the Camera channel (Camera 1/2/3/4) > Camera Pairing 2. A 60 second count down will appear on screen. Within 60 seconds, press and hold the Pairing Key on the power cable of the camera for 2 seconds. <p>NOTE: Once pairing is completed, system will automatically restart upon leaving the MAIN MENU.</p>
2		CAMERA ACTIVATION	<p>Enable/Disable camera connection for camera(s) paired to the WDVR. If you choose to disable the camera connection, live video streaming of that particular camera will no longer be available during the LIVE VIEW mode and there won't be any recording events from this camera.</p> <div style="display: flex; justify-content: space-around; align-items: center;"> <div style="text-align: center;">  Camera On </div> <div style="text-align: center;">  Camera Off </div> </div>

3		RESOLUTION	The DVR system supports High and Normal resolution: Normal resolution setting provides better frame rate and optimized for mobile device display.
4		QUALITY	Select quality of video image: High quality for better video display quality, system will lower the display frame rate as compensation. Lower quality for better display frame rate, system will lower the quality as compensation.

Remote Surveillance Setup:

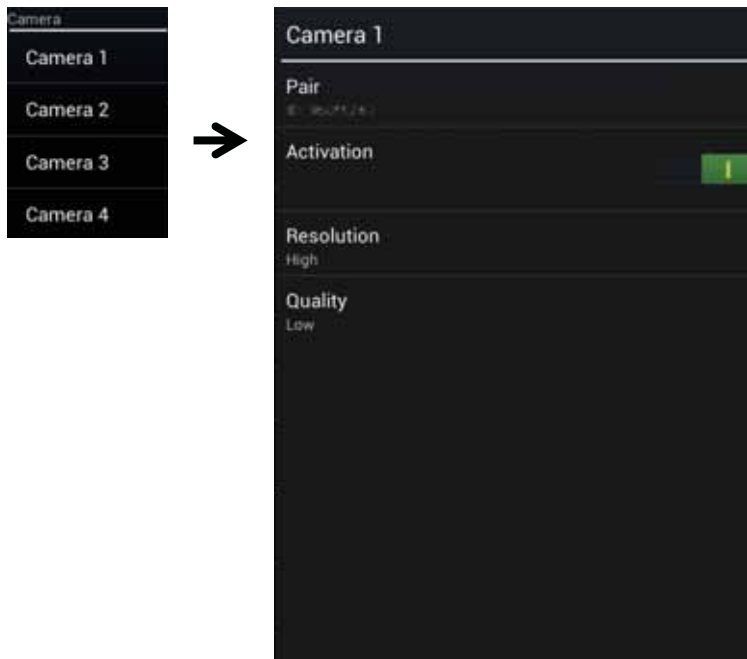

RECORDER SETUP

Record Schedule



	Icon	Main Function	Setup Description
1		CAMERA SELECT	Setup the recording schedule for any or all camera: Select camera 1, 2, 3 or 4 to setup record method, date and time period individually. Select camera all to setup recording for all cameras connecting to the system.
2		RECORD METHOD : Motion	Setup the recording method: Motion – record will begin only when system detects motion (efficient way to save HDD space, suitable for long-term recording).
		RECORD METHOD : Schedule	Scheduled – record will begin/end according to time period predefined by user.
		None	If you don't specify the Record or Method function (as above), it means the system will not perform recording.
3		RECORD DATE SELECT	Select the weekly cycle for recording to take place: Sunday Monday Tuesday Wednesday Thursday Friday Saturday Everyday Monday-Friday Monday-Saturday Saturday-Sunday

4		<p>DEFINED RECORD PERIOD</p>	<p>Setup the record START/END time period.</p>
---	---	------------------------------	--

Note:
 You need to complete schedule setup first so that system will allow motion record/schedule REC. No schedule means WDVR will not perform recording.
 Setup sequence: Select Camera (channel) > Record Method > Defined Record Date/Period.

Remote Surveillance Setup:

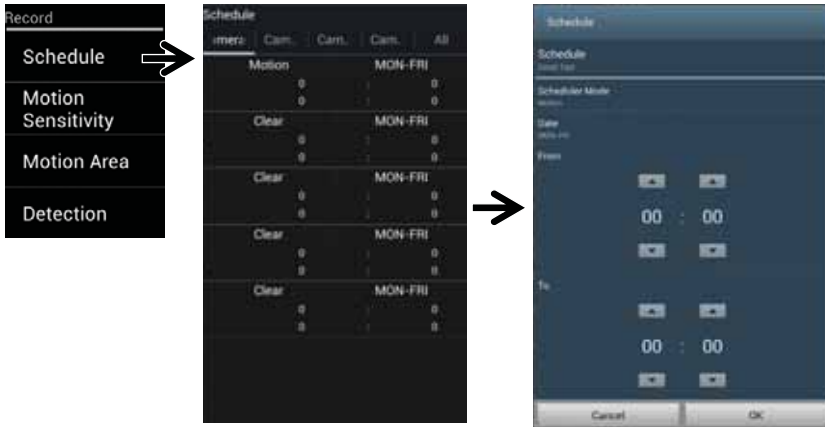

Detection Sensitivity



	Icon	Main Function	Motion Detection Range	Setup Description
1		PIR ONLY	PIR effective within 5M	Detect biomass motion using PIR sensor or embedded software with low sensitivity, whichever detects moving object first.
2		PIR OR MOTION LOW	PIR effective within 5M, software effective within 4M	
3		PIR OR MOTION MID	PIR 5M software 5M	
4		PIR OR MOTION HIGH	PIR 5M software 6M	

Remote Surveillance Setup:



Motion Area



First select the camera for MOTION AREA setup by clicking on camera 1, 2, 3 or 4. Double click on the grid where motion detection is not required.

First click will bring up a visual identification mark, which allows user using large screen TV to easily identify the grid select.

Second click will confirm selection.

Right click will save and leave the motion area setting.

Remote Surveillance Setup:

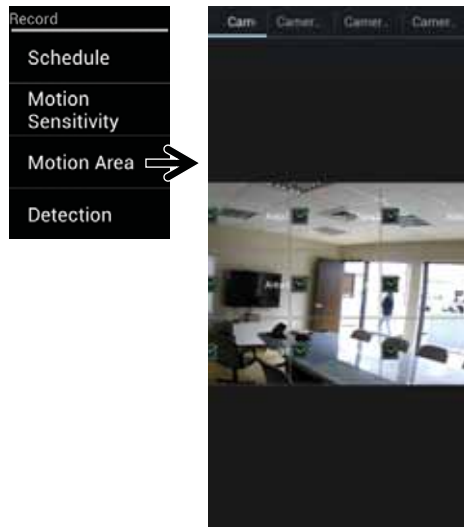

Detection Setup



	Icon	Main Function	Setup Description
1		MOTION RECORD PERIOD	Configure the length of record period upon motion trigger event: 30 seconds 60 seconds 120 seconds Note: REC Time may be extended if the motion continues.
2		PIR OR MOTION LOW	Configure the length of alarm sound period upon motion trigger event: Off 5 seconds 10 seconds
3		PIR OR MOTION MID	Configure the length of video alarm soundperiod upon video loss event: Off 5 seconds 10 seconds

Remote Surveillance Setup:

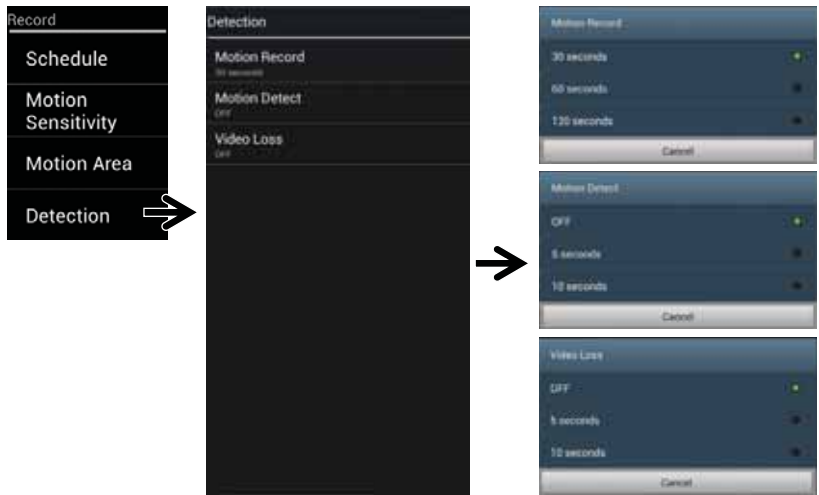

EVENT LIST



	Main Function	Setup Description
1	EVENT PERIOD SEARCH	Predefine event search period by month/year. Use left/right arrow to change search period.
2	CAMEAR SEARCH	Prescreen available recorded video file(s) by camera. System will indicate available recorded video file(s) of the camera selected within the search period via date highlight. Camera 1 Camera 2 Camera 3 Camera 4 All Cameras
3	EVENT INDICATOR	Left click on the date highlighted to see list of available recorded video file(s).
4	EVENT RECORD	Double click on the event to playback recorded video file. Delect selected file or copy selected file to memory card with check mark. You can select multiple files to copy or delect.

Note:

Suggested sequence – first select month, then camera, then date.
Right click to return to previous layer.

SYSTEM SETUP



	Icon	Main Function	Setup Description
1		DATE and TIME	Use Up/Down arrows to adjust YEAR/MONTH/DATE/HOUR/MINUTES. Use right mouse key to save and exit.
2		LANGUAGE	Setup the system language. After system language selected, all system setting will be restored into factory default.
3		DISPLAY SETUP	Activate/Deactivate following icons on screen display: Signal Strength Indicator Time Stamp
4		IDLE DISPLAY SETUP	Setup display mode during system idle: QUAD SMART-QUAD AUTO-SCAN 10 SEC AUTO-SCAN 5 SEC



5		POWER SAVING SETUP	<p>Setup power saving mode:</p> <ul style="list-style-type: none"> Enter Power Saving mode after system idle for 5 minutes Enter Power Saving mode after system idle for 10 minutes Screen always on (deactivate Power Saving) <p>Note: By setting up power saving, video will stop sending to TV via HDMI. Most TV will turn off backlight to save power. Suggest to enable the power saving function.</p>
---	---	--------------------	---



Remote Surveillance Setup:



STORAGE SETUP



	Icon	Main Function	Setup Description
1		STORAGE SETUP	Activate/Deactivate the Overwrite function for HDD and memory card.
2		STORAGE FORMATTING	Format HDD or memory card. Formatting the storage will erase all stored data.
3		NETWORK SETUP	<p>Setup Network Connection and Security Code (remote access):</p> <p>Static IP – if you are using fixed IP address, please obtain and enter IP information provided by your local ISP.</p> <p>DHCP – if you are using dynamic IP address, simply select DHCP and there is no need to enter any additional IP address information.</p> <p>For Security Code, you may enter your own unique password to avoid others to have access your security data. Up to 12 characters of number and alphabet can be used.</p> <p>Click on "OK" to save setting and exit.</p>

			<p>The Network Connection status will be displayed on view screen via the following icons:</p> <p> Network Connection is normal</p> <p> No Network Connection available. Please check to make sure the WDVR receiver is connecting to router via the RJ45 cable provided. Abnormal Network Connection.</p>
4		SYSTEM INFO & UPGRADE	<p>Display System information: WDVR Receiver Firmware Version WDVR Camera 1/2/3/4 Firmware Version System ID DID Security Code Internet IP & Server</p> <p>System Upgrade: Click on screen any location to begin system upgrade process</p>

Remote Surveillance Setup:



TROUBLE SHOOTING

Problem	Possible Cause / Possible Solution
"No Signal" or "No Video"	No Power supply to camera → Check power adapter and power cord connection
	The camera is not paired with WDVR or signal disconnected → Unplug camera power then plug on again to reconnect. → Please refer to Pairing section in Advanced Operation chapter for detail."
	Service out of range → Relocate WDVR or camera for better reception → Adjust antenna or use WDVR proprietary extension cable with high gain antenna to improve range. Please contact the store from which you made the purchase.
	Signal has been blocked. → If possible, remove major obstacles in between cameras and WDVR or relocate camera/WDVR away from water tank(aquarium), metal covered surface(tin roof/ metal door) and brick/marble wall
Low or unstable streaming video	Antenna directional limitation → Relocate WDVR or camera for better reception → Adjust antenna or use WDVR proprietary extension cable with high gain antenna to improve range. Please contact the store from which you made the purchase.
	Strong electromagnetic interference near by → Keep working motors (hair dryer / heat fan / air conditioner / water pump) or microwave oven away from the cameras and WDVR.
	Busy signal in air or wireless bandwidth is low → keep camera away from each other 3 meters or above → keep wifi router or hot spot away from camera → From [camera setup], lower the camera resolution and quality to save bandwidth consumption in the air and receive more streaming video.

WDVR cannot record	Record schedule does not setup properly → Set proper schedule to each camera to enable recording
	Storage media not ready → Use recommended storage media brand/model/spec, check appendix → Install/uninstall storage media AFTER WDVR is powered off. → Use WDVR to format storage media then try again. → Only install one HDD or Flash disk to WDVR.
Miscellaneous TV display problems	Camera color distortion → Adjust TV contrast/brightness/saturation/sharpness → Avoid direct sunlight into camera lens Low or no camera audio/alarm sound → Adjust TV audio volume → From [Recorder Setup] - [Detection Setup], turn on alarm sound No TV display → Check HD interface cable connection, use the HD interface cable provided with the package. → Change a HD cable and try again, 1.5M or shorter is suggested Compatible issue may happen. → Power save function is enabled. From [System Setup], set power save function always ON.
WDVR Cannot remote view	WDVR is not connected to internet properly → Make sure router DHCP and UPnP is enabled. → TCP port #6000 and TCP port #80 should be opened. WDVR may use some numbers of UDP ports assigned by your home router for network transmission. Please make sure these ports are opened. Consult your router provider for details if necessary. → Make sure the Ethernet cable connection to router is solid. → Connect WDVR directly after the router, do not connect WDVR to router through a hub or switcher. → Exit WDVR menu then try again. → Make sure the bandwidth is sufficient enough. Each remote connection requires 1.5Mbps. → Make sure Android pad/smart phone is 1.5G/dual core processor; iPhone4S/New iPad or above → General routers require 30 seconds to initiate WDVR network connection. → Maximum number of remote viewer is 3, the 4th connection may be rejected.

PRODUCT SPECIFICATION

Receiver Unit

Compression Format	H.264
Video Resolution	High Definition 720P
Viewing Options	Full Screen/QUAD/Smart-QUAD
Storage Media	Internal 500GB SATA HDD x 1 (Optional, support upto 2TB); SSD compatible (not included) Memory card slot (up to 32GB; for footage backup only; memory card not included)
Motion Detection	PIR On/Off setting for each camera
Record Mode	Schedule/Motion Detection/ Manual
HD Interface	Support (High Definition Monitor Viewing)
Network Interface	RJ45 (LAN, Internet)
Ethernet Output	10/100Mbps
Mouse Control	Yes
Power Supply	DC 12V/3A
Operating Temperature	-10°C ~ +40°C
Storage Temperature	-20°C ~ +50°C

Camera Unit

Transmission Distance	200 Meters in open space
Image Resolution	640 x 480 (VGA)
Housing	Weather resistance metal
Viewing Angle	H: 55° +/- 3°; V: 44+/-3°
Low Light Solution	6 IR LEDs w/ IR CUT switcher
Night Visibility	8 Meters
Power Supply	DC 5V/1A
Operating Temperature	-10°C ~ +40°C

APPENDIX 1: COMPATIBLE LIST

Wireless DVR Hard Disk Compatible List (External USB HDD)

Category	Manufacturer	Model No.	Form Factor	USB Standard	Capacity
USB HDD	Silicon Power	/	2.5"	USB 3.0	500GB
	Transcend	storejet	2.5"	USB 3.0	500GB
	Toshiba	593400-A	2.5"	USB 2.0	500GB
	WD Elements	Elements portable	2.5"	USB 3.0	1TB
	Seagate	STBX1000301	2.5"	USB 3.0	1TB
	WD Elements	WDBUZG0010BBK	2.5"	USB 3.0	1TB
	Note: The model below is known to be NOT Compatible				
	ADATA	HV610	2.5"	USB 3.0	1TB

Wireless DVR USB Flash Drive Compatible List

Category	Manufacturer	Capacity	Model No.	USB Standard
Flash Memory	Sandisk	CZ48		USB 3.0
	Sandisk	CZ33		USB 2.0
	Toshiba	UHYBS-032GH		USB 2.0
	Toshiba	THV3SZK-32G-BK		USB 3.0
	PNY	OPENER		USB 2.0
	PNY	Attaché		USB 3.0
	Transcend	JetFlash		USB 3.0
	Kingston	DTSE9		USB 2.0
	Kingston	DTM30		USB 3.0
	Note: The model below is known to be NOT Compatible			
	Transcend	TS32GJF350		USB 2.0

Wireless DVR Memory Card Compatible List (T-Flash)

Category	Manufacturer	Model No.	Speed	Capacity	
Memory Card	Kingston	/	Class-10 (Read up to 45MB/s, Write up to 10MB/s)	32GB	
	Sandisk	/	Class-10 (Read/Write up to 30Mb/s)	32GB	
	Sony	/	Class-10 (Read/Write up to 40Mb/s)	32GB	
	Samsung	/	Class-10 (Read/Write up to 48Mb/s)	32GB	
	Toshiba	/	Class-10 (Read/Write up to 30Mb/s)	32GB	
	Transcend	TS32GUSDC10	Class-10 (Read/Write up to 25Mb/s)	32GB	
	Kingston	/	Class-10 (Read up to 45MB/s, Write up to 10MB/s)	16GB	
	Toshiba	/	Class-10 (Read/Write up to 30Mb/s)	16GB	
	Transcend	TS16GUSDC10	Class-10 (Read/Write up to 20Mb/s)	16GB	
	Kingston	/	Class-10 (Read up to 45MB/s, Write up to 10MB/s)	8GB	
	Pny	SDHC C10	Class-10 (Read/Write up to 30Mb/s)	8GB	
	Toshiba	/	Class-10 (Read/Write up to 30Mb/s)	8GB	
	Note: The model below is known to be NOT Compatible				
		Transcend	TS8GUSDC10	Class-10 (Read up to 25MB/s, Write up to 12MB/s)	1TB

APPENDIX 2: RECORDING CAPACITY

1CH VGA@High	TF Card	Flash Drive	Hard Drive
4GB	11 hours	11 hours	-
8GB	22 hours	22 hours	-
16GB	45 hours	45 hours	-
32GB	92 hours	92 hours	-
500GB	-	-	60 days
1TB	-	-	120 days

4CH VGA@High	TF Card	Flash Drive	Hard Drive
4GB	3 hours	3 hours	-
8GB	6 hours	6 hours	-
16GB	11 hours	11 hours	-
32GB	23 hours	23 hours	-
500GB	-	-	15 days
1TB	-	-	30 days

This device complies with Industry Canada licence-exempt RSS standard(s). Operation is subject to the following two conditions: (1) this device may not cause interference, and (2) this device must accept any interference, including interference that may cause undesired operation of the device. Le présent appareil est conforme aux CNR d'Industrie Canada applicables aux appareils radio exempts de licence. L'exploitation est autorisée aux deux conditions suivantes : (1) l'appareil ne doit pas produire de brouillage, et (2) l'utilisateur de l'appareil doit accepter tout brouillage radioélectrique subi, même si le brouillage est susceptible d'en compromettre le fonctionnement.

The distance between user and products should be no less than 20cm
La distance entre l'utilisateur et de produits ne devrait pas être inférieure à 20cm

Changes or modifications not expressly approved by the party responsible for compliance could void your authority to operate the equipment.