

QUICK START GUIDE

AWF53 HD Outdoor PT Network Camera KIT CONTENT:

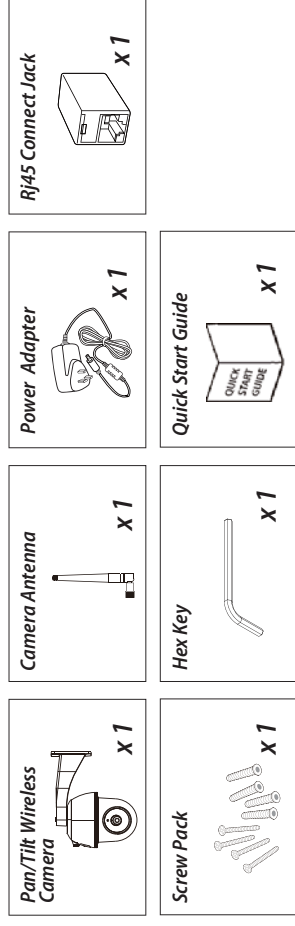

FRIENDLY REMINDER

- For video recording, BE SURE TO use CLASS 10 memory card or above (not included). Other kinds of memory card may cause unexpected results and should be avoided.
- Anytime when you find the camera pan/tilt function does not perform properly, calibrate the camera to get correct principle position (refer to step 8 of setup the camera section).
- For better performance, please enable the video hardware acceleration function. This function only for Android (refer to the app introduction section).

PRODUCT OVERVIEW

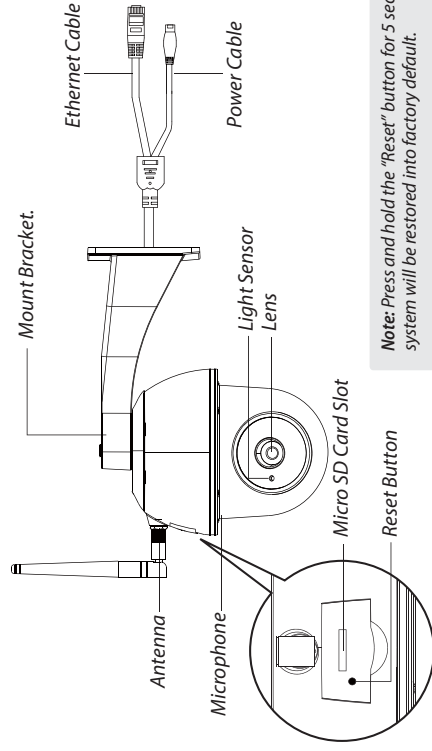

SETUP THE CAMERA

1. APP Download

Download and install the "OMGuard HD" APP to your device.



For iOS



For Android

2. Power up The Camera

Connect the power wires to the adapter supplied, and wait until the RED LED indicator becomes steady on. This process would be finished within 1 min and make sure the LED is flashing in RED.

3a. Wireless Connection

- (1) In the Wi-Fi setting of your smart device. Choose the Wi-Fi router with prefix of HD-xxxxxx (xxxxxx=Camera ID numbers). Then enter the default password 12345678.
- (2) Launch the APP, tap  to add the camera.
- (3) Tap (QR code icon) and scan the QR code label on the back of the camera to bring up the DID information. Or tap "Search" to locate the camera.
- (4) Enter the default password 123456.
- (5) Tap "Save" when you done.
- (6) Later, APP will request user to modify the default password to private password.

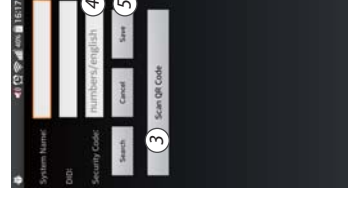
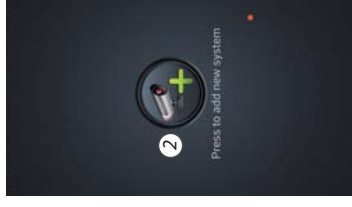
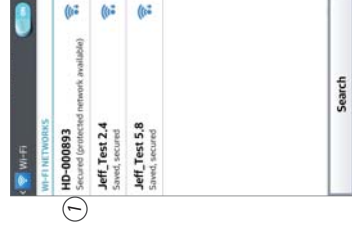

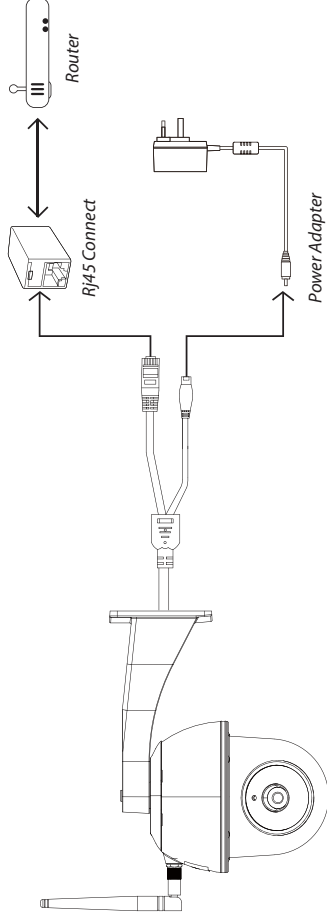

3b. Wired Connection



- (1) Make sure your smartphone is connected your Wi-Fi router.
- (2) Connect the camera's Ethernet cable to the RJ45 connect, and power on the camera with adapter.
- (3) Launch the APP, tap the "Search" to locate the camera.
- (4) Enter the default password 12345678 and save the settings.
- (5) Later, APP will request user to modify default password to private password .

Note: In soft AP mode, the RED LED long flashes once followed by 2 short flashes. In normal mode, the LED is flashing in RED.

4. Wi-Fi Setting

- (1) Tap  then the advanced setting icon  will appear on the screen.
- (2) Enter the default password : 12345678
- (3) Select your Wi-Fi router, and enter its password.
- (4) The Camera will offline for around 40 seconds to reboot for Wifi connection. When camera connects to Wi-Fi router correctly, the RED LED will stay ON.
- (5) In the Wi-Fi setting on your smart device again, make sure the Wi-Fi router you are connecting to is the same as the camera. If not, manually assign to it.

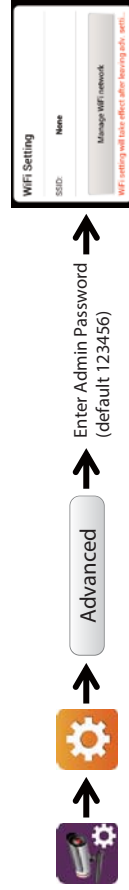

Choose the appropriate Wi-Fi router on your local network

Note: If you fail to add the camera for several times, press and hold the "Reset" button for 5 seconds to reset it.

APP INTRODUCTION



Follow the steps below for Event Playback

- (1) Tap the  icon to access the event list section.
- (2) Select the time interval for the event list.
- (3) Select the file you want to playback.
- (4) If you want to store the files to the mobile device, tap  to download the files (Best while under Wi-Fi environment due to larger high definition data size).



Enable video hardware acceleration (For Andriod)

- (1) In the camera list, tap the 
- (2) Click the click box to enable video hardware acceleration.

(1)

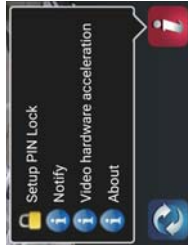

(2)



CAMERA INSTALLATION

- (1) Drill the mounting holes by using the alignment paper.
- (2) Insert 4 screw anchors into the wall.
- (3) Insert 2 screws into the screw anchors, reserved space 8 to 10 mm. Then Hang the camera on 2 screws.
- (4) Fasten 4 screws by using hex key.

Note: Before mounting the camera, install the memory card if you prefer recording to local storage.

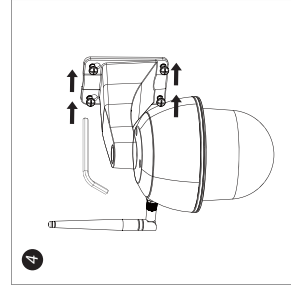
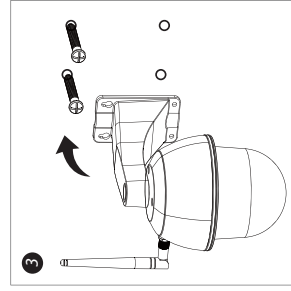
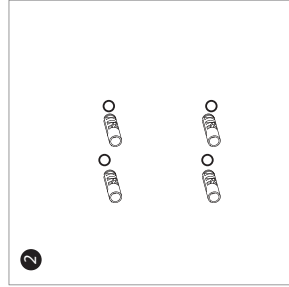
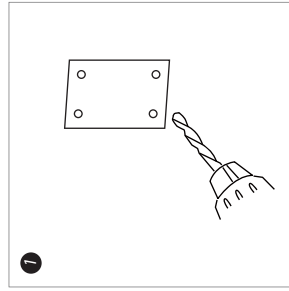

Changes or modifications not expressly approved by the party responsible for compliance could void the user's authority to operate the equipment.

This equipment has been tested and found to comply with the limits for a Class B digital device, pursuant to Part 15 of the FCC Rules. These limits are designed to provide reasonable protection against harmful interference in a residential installation. This equipment generates uses and can radiate radio frequency energy and, if not installed and used in accordance with the instructions, may cause harmful interference to radio communications. However, there is no guarantee that interference will not occur under all conditions. If interference does occur, it is recommended that the user be advised to take the following measures which can be determined by turning the equipment off and on, the user is encouraged to try to correct the interference by one or more of the following measures:

- Reorient or relocate the receiving antenna.
- Increase the separation between the equipment and receiver.
- Connect the equipment into an outlet on a circuit different from that to which the receiver is connected.
- Consult the dealer or an experienced radio/TV technician for help.

This device complies with part 15 of the FCC rules. Operation is subject to the following two conditions: (1) This device may not cause harmful interference, and (2) this device must accept any interference received, including interference that may cause undesired operation.



Products with CE Marking comply with EMC Directive (2014/53/EU); Low Voltage Directive (2014/35/EU); RED (2014/53/EU); RoHS Directive (2011/65/EU) issued by the Commission of the European Community. Compliance with these directives implies conformity to the following European Norms:
EMC: EN 301 489
LVD: EN 60950
Radio: EN 300 328



If the camera system no longer functions or can no longer be repaired, it must be disposed of according to the valid statutory regulations. Disposal of spent batteries/accumulators:
You are required by law (Battery Ordinance) to return all spent batteries and accumulators. Disposing of spent batteries/accumulators with common household waste is prohibited! Batteries/accumulators that contain hazardous substances are marked with the symbols on the side. These symbols indicate that it is prohibited to dispose of these batteries/accumulators in the household waste. The abbreviations for the respective heavy metals are: Cd=cadmium, Hg=mercury, Pb=lead. You can return spent batteries and accumulators that can no longer be charged to the designated collection points in your community, outlets, or wherever batteries or accumulators are sold. Following these instructions will allow you to fulfill the legal requirements and contribute to the protection of our environment.