

QUICK START GUIDE

HD Monitoring System Accessory Camera
AWSC37

KIT CONTENT *Quantity varied subject to configuration

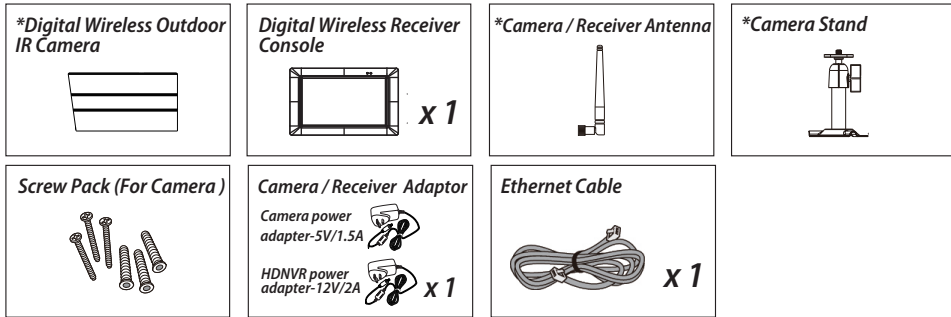

PRODUCT OVERVIEW

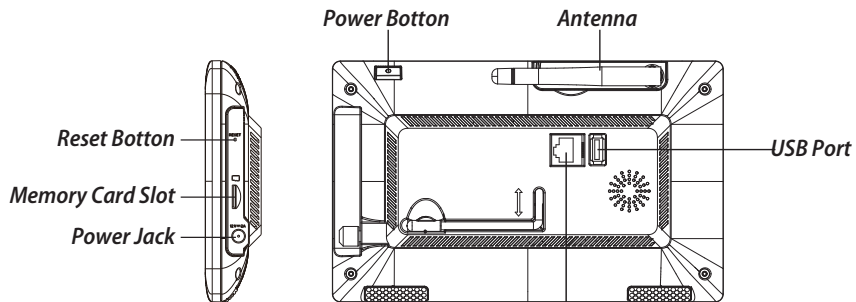

Note: Before using the memory card/ HDD for recording video, you **MUST** format the memory card/ HDD on the console.

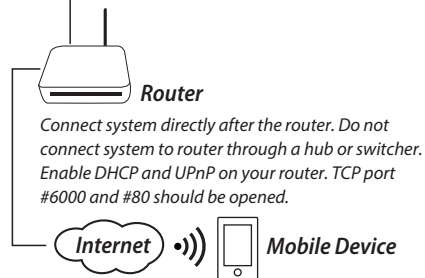

INSTALLING YOUR DEVICES

A. Setting up your monitor

1. Insert the memory card and/or connect HDD device to USB port.
2. Twist on the antenna to the LEFT side of the console.
3. Connect the Ethernet cable from the BACK of the console to your router.
4. Connect the 12V power adaptor and power on the system.
5. Twist on the stand to the back of the console.

Note: Keep distance between device minimum 1 meter.

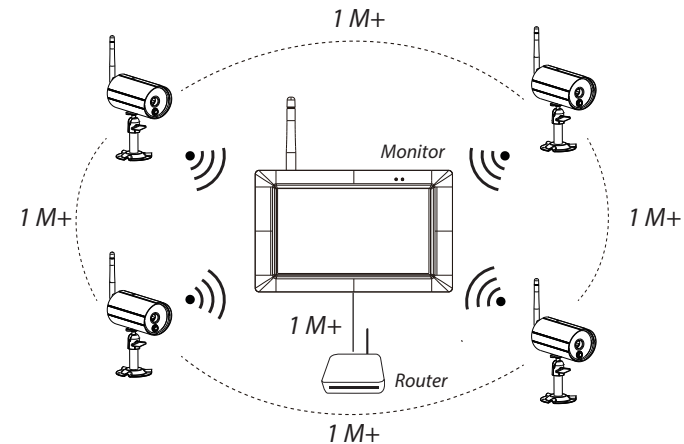

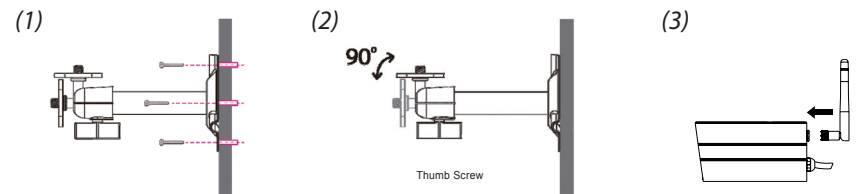

B. Installing your camera

1. Secure the camera stand to a stable surface, ceiling or wall mount using three pcs screws.
2. Loosen the thumb screw of the camera stand and secure the camera body to the bracket.
3. Screw the antenna into rear of the camera.
4. Connect the supplied power adaptor to the camera and the power source. The RED LED will light up which indicate the camera is ready for setup.



SYSTEM OPERATION

Main Menu

1. Tap  to extend quick select menu.
2. Tap  to enter main menu.



1. **Camera Setup:** Pair camera, and video quality.
2. **Recorder Setup:** Setup recording settings such as date, recorder type, and motion area.
3. **Event list:** Event video playback.
4. **System Setup:** Setup system time, powersaving mode, and restore default system settings.
5. **Storage Setup:** Management storage.

Pair the camera to HDNVR

If you have additional cameras disconnected with HDNVR, follow steps below to pair:

1. Tap the camera setup icon to access the camera pairing screen.
2. Select the Camera channel (Camera 1/2/3/4).
3. Tap the "Camera Pairing" icon.
4. Within 35 seconds, press and hold the pairing button on the back of the camera for 5 seconds. The Green Link LED will light up which indicate the camera is paired successfully.

Quick Select Menu



Display/Undisplay Menu



Enter Main Menu



QUAD Display Select



Smart-QUAD Display Select



Single Channel Record/
Stop Single Channel Record



All Channel Record/Stop
All Channel Record



Volume Control
Mute/Vol1



Vol2/Vol3

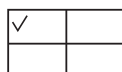

Tap one quadrant to choose the current channel, and a red checkmark ✓ will display. HDNVR will display audio from the current selected channel.

Live View with Quad Display

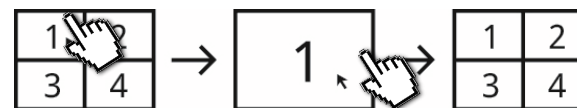

Tap one channel

Live-view full screen

Tap again to return

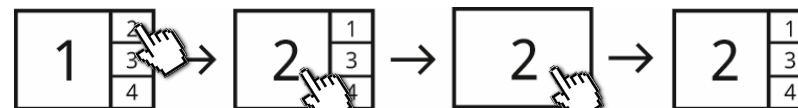

Tap one channel

Show it at left side

Live-view full screen

Tap again to return

Live View with Dynamic Display



Tap to turn on/off the camera



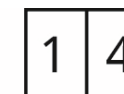

Turn CH2 off



Turn CH2/CH3 off

SETUP THE HDNVR

1. Connect the device to your router, and make sure DHCP and UPnP service are enabled on your router setting.
2. Power up and turn on HDNVR.
In the Live View mode, wait until  logo turns  or .
This means system is now ready for internet connection. The process takes around 30 seconds.
3. Download the "WDVR Cam" app and run the app on a phone or tablet.



For iOS



For Android

4. Add New Device

Andriod: Tap the "NEW" icon to add new device.

iOS: Tap the "+" icon to add new device.

5. Tap the "scan QR code" located on the rear of the device. Also you can enter the ID manually.

Note: If you have not installed the app to scan the QR code, we suggest to download and install the app "Barcode Scanner".

6. Enter the default password "123456". Give your remote access a name and tap "save" to exit.

7. Change the default password:

For privacy matter, follow the steps below to change the security code on both device and app.

- a. Device:**
1. In the main menu section, tap storage setup
 2. Tap network setting
 3. Click DHCP then changes the password
 4. Tap "OK" once you're finished password modification



b. W DVR CAM APP

For Andriod

1. Go to the device list
2. Press and hold the device name, the menu will appear on the panel. Then tap "modify".
3. Tap "update" once you're finished password modification

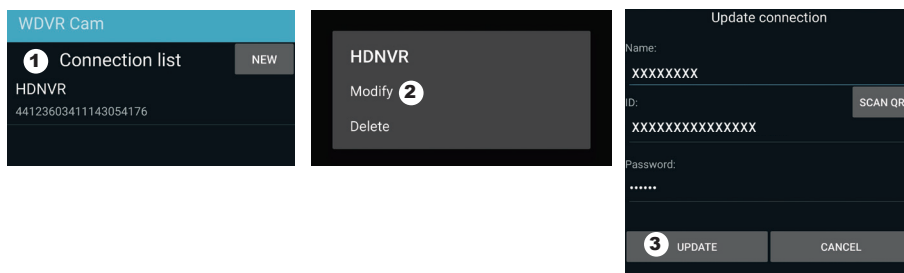

For iOS

1. Tap the "+" icon to enter device list
2. Tap [Edit] button
3. Change default password



8. Tap the device from the list, then tap "play" to connect. It will take a few seconds to access the remote video, depending on the network environment.

Note:

HDNVR allows max 3 remote viewers to access the system at a time. The 4th connection will be rejected. When a local user is operating setup menu. The remote user will be temporarily rejected to access HDNVR until the local user leaves the setup menu.

HDNVR requires 1.5Mbps connection bandwidth per connection to receive best viewing quality/streaming. It is suggested to set camera resolution and quality to "Low" in order to receive streaming remote view if the bandwidth is below 1.5Mbps.

APP INTRODUCTION

Andriod

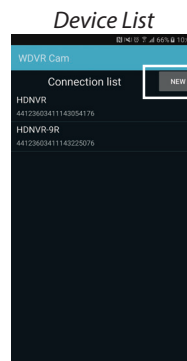

Live View

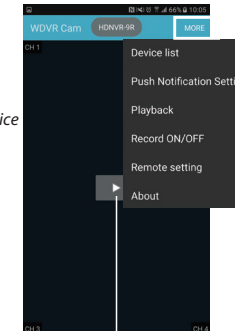

iOS

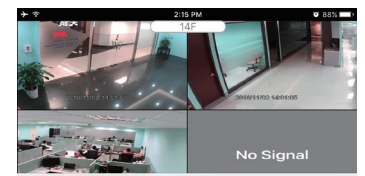

* Tap play to connect HDNVR, then tap the "more" icon that setting menu will show up.

Snapshot

Push Notification

a. Enable/disable the push notification:

For Andriod

1. Go to more section to tap Push Notification.
2. Click/unclick to enable/disable the push notification.
3. Enter user name.
4. Tap "OK" when you done.

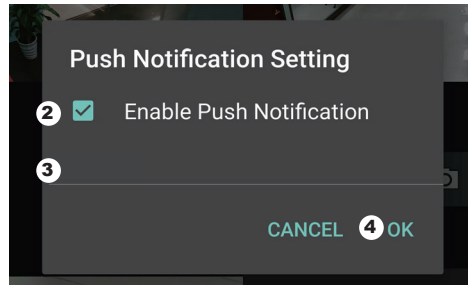
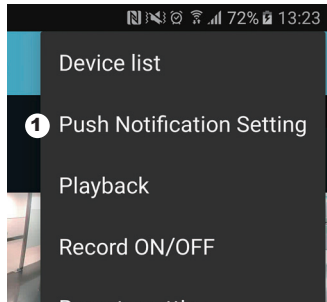

For iOS

1. Tap  icon.
2. Enable/disable the push notification.
3. Enter user name.
4. Tap "Save" when you done.

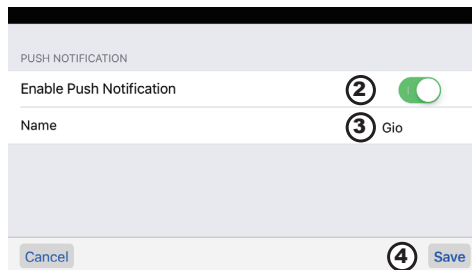
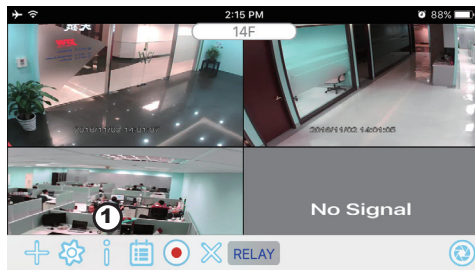

b. interval

Go to the push notification setting to setup interval time of the push. There are four options you can select how long you'll receive the push.

Note: Your smart phone will receive the push immediately after first triggered. After that the camera will send the push according to interval time you setup. This function allows you to receive less push of one serial event happened continuously in time.

For Andriod

1. Tap push notification setting
2. Setup interval time of the push

For iOS

1. Tap push setting
2. Setup interval time of the push

c. Time period:

This function allows you to setup "Do Not Disturb" time. You can setup when Push is to start and end. Only during the time, you will receive the push.

d. List:

From list section, you can see which smart devices currently receive push from the system. WDVR app allows max 8 devices to receive the push. You may remove all devices from the push list by resetting the language.

FACTORY DEFAULT SETTING

1. Go to the system setting.
2. Reset the language.
3. The system will restore to factory default.

Note: Please change default security code and apply push service from smart devices after you reset the language and system parameter to default.

FCC Statement

Changes or modifications not expressly approved by the party responsible for compliance could void the user's authority to operate the equipment.
This equipment has been tested and found to comply with the limits for a Class B digital device, pursuant to Part 15 of the FCC Rules. These limits are designed to provide reasonable protection against harmful interference in a residential installation. This equipment generates uses and can radiate radio frequency energy and, if not installed and used in accordance with the instructions, may cause harmful interference to radio communications. However, there is no guarantee that interference will not occur in a particular installation. If this equipment does cause harmful interference to radio or television reception, which can be determined by turning the equipment off and on, the user is encouraged to try to correct the interference by one or more of the following measures:
-- Reorient or relocate the receiving antenna.
-- Increase the separation between the equipment and receiver.
-- Connect the equipment into an outlet on a circuit different from that to which the receiver is connected.
-- Consult the dealer or an experienced radio/TV technician for help
This device complies with part 15 of the FCC rules. Operation is subject to the following two conditions (1) this device may not cause harmful interference, and (2) this device must accept any interference received, including interference that may cause undesired operation



Products with CE Marking comply with EMC Directive (2014/30/EU); Low Voltage Directive (2014/35/EU); RED (2014/53/EU); ROHS Directive (2011/65/EU) issued by the Commission of the European Community. Compliance with these directives implies conformity to the following European Norms:
EMC: EN 301 489
LVD: EN 60950
Radio: EN 300 328



If the camera system no longer functions or can no longer be repaired, it must be disposed of according to the valid statutory regulations. Disposal of spent batteries/accumulators:
You are required by law (Battery Ordinance) to return all spent batteries and accumulators. Disposing of spent batteries/accumulators with common household waste is prohibited! Batteries/accumulators that contain hazardous substances are marked with the symbols on the side. These symbols indicate that it is prohibited to dispose of these batteries/accumulators in the household waste. The abbreviations for the respective heavy metals are: Cd=cadmium, Hg=mercury, Pb=lead. You can return spent batteries and accumulators that can no longer be charged to the designated collection points in your community, outlets or wherever batteries or accumulators are sold. Following these instructions will allow you to fulfill the legal requirements and contribute to the protection of our environment!