

# Wi-fi set-up

## Air 100/200 V2 Wireless music system

To enjoy Airplay and internet radio, you must first connect your Air to your home network.

If you have a laptop computer, tablet, or any other wi-fi enabled internet browser go to Step 1 below to connect to your home network.

If you have no wi-fi enabled internet browser (such as a desktop computer) then please see the online user manual for wired set-up instructions.

**1** Plug in the Air to the mains power and press the power button  on top of the unit. Wait for up to 20 seconds for the flashing light on the rear panel to flash green  and orange .

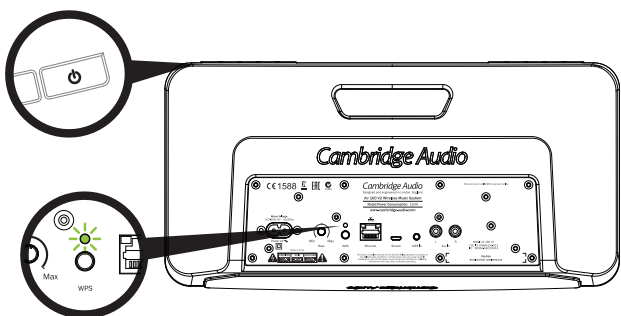

**2** Go to your computer and click on the WiFi/network logo and select Air xxx Setup nnnn.



**3** Open a new page in your internet browser (Internet Explorer, Safari, Chrome etc). In the address bar of your browser, type 192.168.1.1 followed by 'enter' and the Air setup page will be displayed.

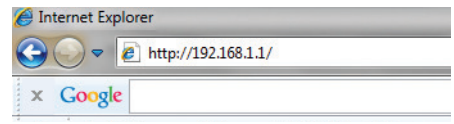

**4** Select your home Wi-Fi network from the 'Service Set ID (SSID)' drop-down list of choices.

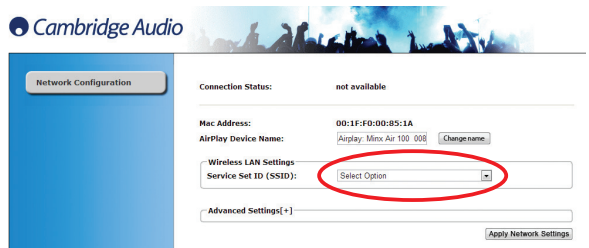

**5** Type your home Wi-Fi/Network password into the red box, and click the 'Apply' button. (Don't know your Wi-Fi password key? It's commonly found on a label on your internet modem/router)

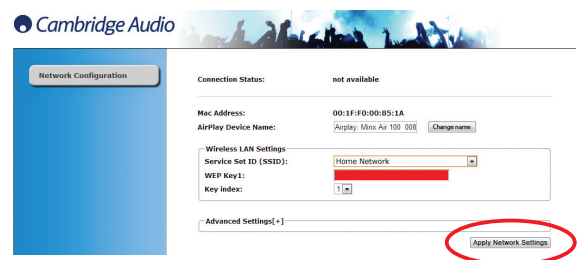

**6** If you are happy that you have entered your details correctly, click 'OK' to finish. The Air set-up page may now display an 'error' or 'no data received' type message. Don't worry, this is normal. You can now close your internet browser.

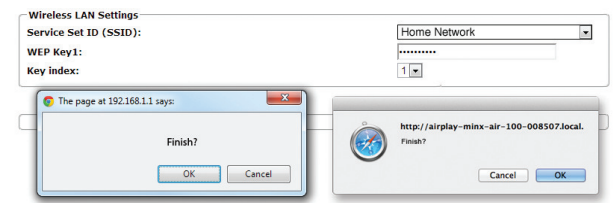

**7** After a few seconds, the Air will be connected to your network (successful connection is indicated by a solid green light on the rear of the product). This can take up to 30 seconds. (If your computer/tablet has not already done so automatically, change the Wi-Fi/network setting on your computer/tablet back to your home network).

**Airplay**  
 Congratulations! You are now ready to stream music via Airplay. When you open iTunes or your Music you will see the Airplay logo  allowing you to select your Air as the playback device. Note - when Air is selected, it will take a few seconds to connect. **Wait for the music to start playing before adjusting the volume.**



**Made a mistake?**  
 To reset the Air, press and hold the power button and WPS button on the rear panel for 10 - 15 seconds until the Air switches off. Then start again at Step 1. You can also watch the Air connection videos on the Cambridge Audio website for further explanation.

# Bluetooth

- 1 Press the  button on the Air to put your Air into Bluetooth pairing mode.
- 2 Enable Bluetooth connectivity on your Bluetooth device (eg. phone, tablet, etc) and pair with the Air (you may need to consult your phone or tablet operating instructions).
- 3 Once paired, music from your device will play through the Air.

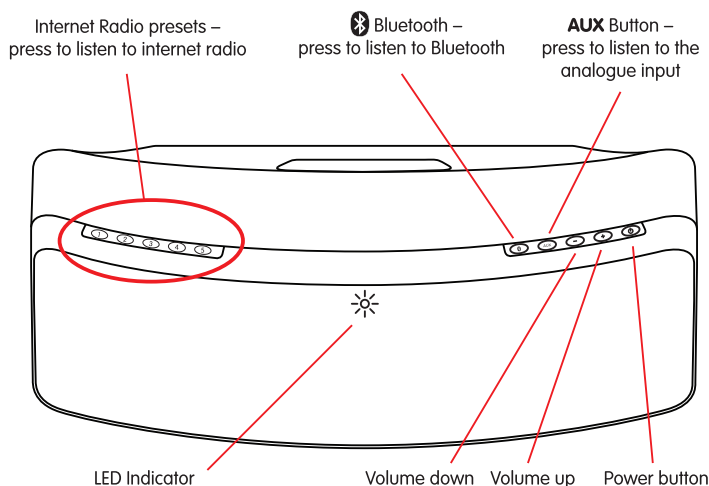

# Internet Radio

Once you have connected your Air to your home network (see overleaf) then you're ready to listen to internet radio!

To get you started, we've stored 10 of our favourite internet radio stations in your presets. Presets 1-5 can be easily selected and played by pressing buttons 1-5 on the top of the unit.

Presets 1-10 can be selected using the remote control or the free Air App.

Also, using the Air App, you can search for new stations from around the world and change the presets to your own preferred stations.

## LED Indication

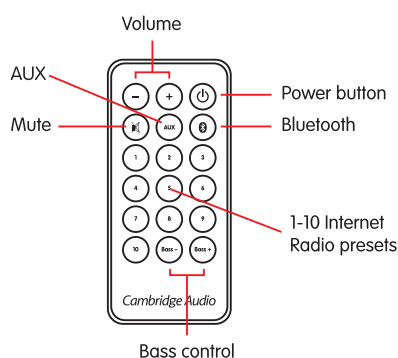
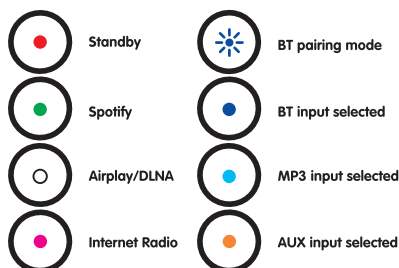

## Top tips

### Get the free Air App



Register your Air system using the App for FREE lifetime technical support!

Search for internet radio stations from around the world, control the volume, bass and EQ settings from the comfort of your armchair.

Free Air App download from the iTunes App store or Google Play store (requires iOS 6 or later/Android 4.4 or later).

### Bass control



Adjust the bass of your Air to your listening environment. The bass can also be controlled from the Air App and the remote control.

### AUX button

Press AUX once to stop the playback of Airplay, Bluetooth or Internet radio or to select the analogue input.

Press AUX a second time to mute playback of the analogue input

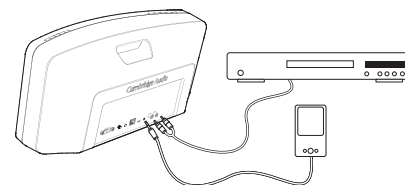

### Auto power down

The Air will automatically turn off after four hours use. This environmental feature can be adjusted or disabled in the Air App, available from the iTunes App store or Google Play store.



## Help and Troubleshooting

For set up videos and FAQs visit: [www.cambridge-audio.com/AirSetup](http://www.cambridge-audio.com/AirSetup)  
Consult the online user manual for more detailed information.

To talk to us, call +44 (0)20 3514 1521 (UK Local) or 1 8773578204 (USA)

Cambridge Audio  
Your music + our passion