

# August Smart Lock - Installation Guide

## **Welcome!**

This guide will get you up and running with your August Smart Lock. Installation generally takes less than 15 minutes. If you have any trouble, please call our customer support team at the number included in your Getting Started guide, or email [support@august.com](mailto:support@august.com).

## **Confirm Lock Compatibility**

Make sure your existing deadbolt is compatible with the August Smart Lock. Only standard single-cylinder deadbolts are supported. Use our compatibility assistant to double-check: [august.com/compatibility](https://august.com/compatibility).

## **What's In the Box**



August Smart Lock

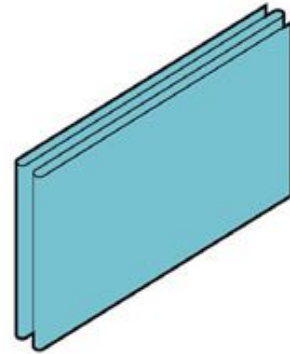

Adhesive Strip



3 Adapters

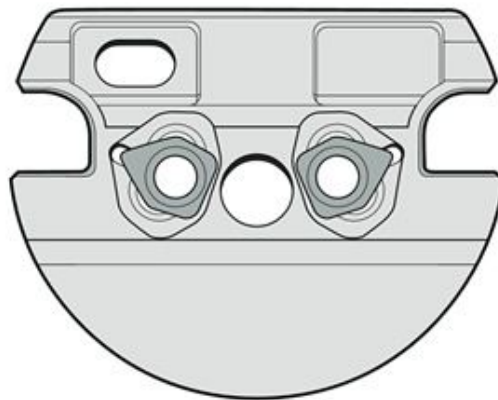

Universal Mounting Plate

1 August Smart Lock (AA batteries included)

1 Adhesive strip

3 Adapters

1 Mounting Plate

### **What You'll Need**



Phillips Screwdriver

**1. Prepare your existing deadbolt.**

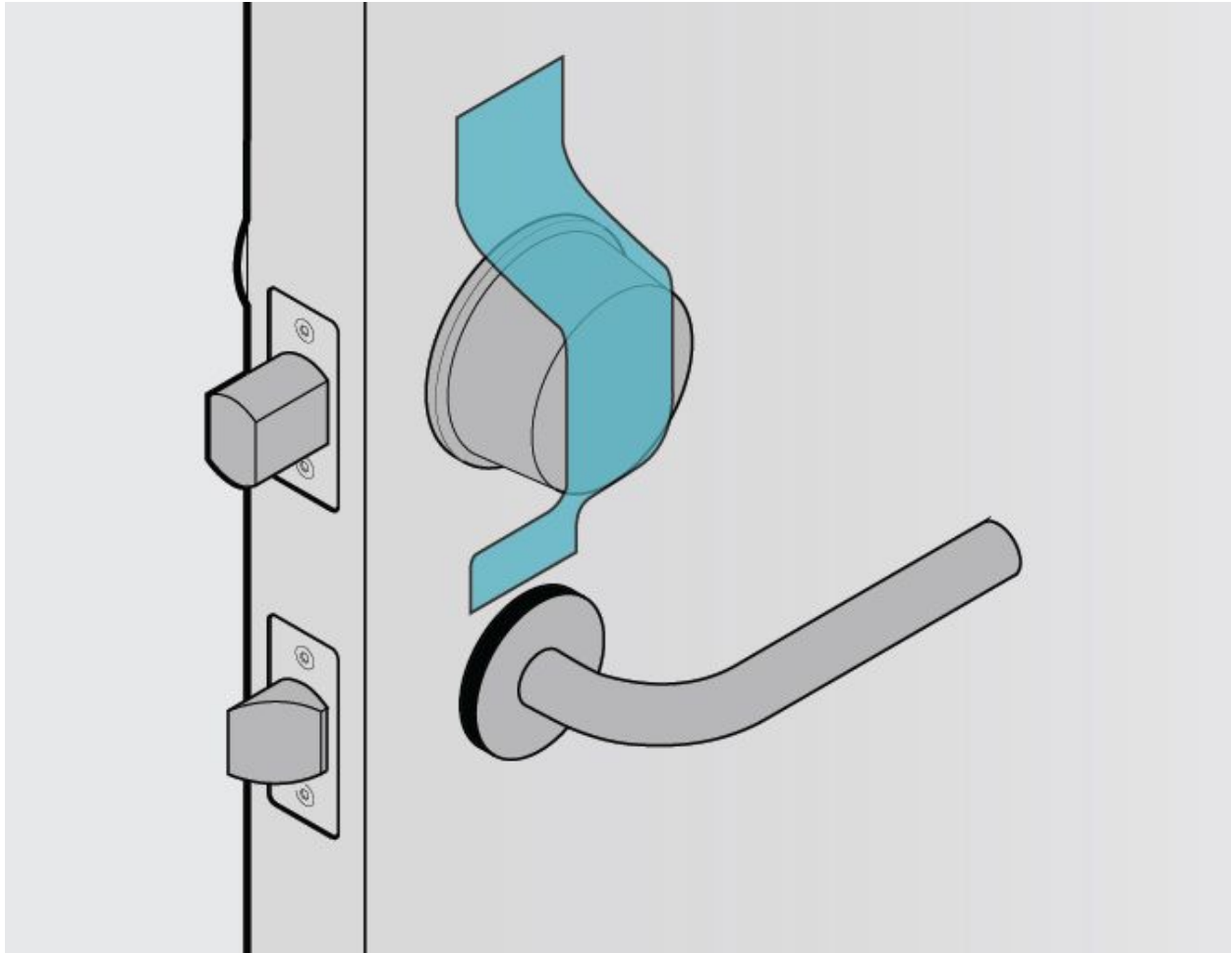

Affix the supplied adhesive strip over the keyhole, securing it to the exterior side of your door. This should hold the key hole in place when you remove the thumb-latch on the inside of the door.

On some doors, such as those with glossy paint, the included tape may not be strong enough. In this case you should apply additional stronger tape to ensure that the key hole stays in place. Use caution. Some types of tape, such as duct tape, may damage the paint on certain types of doors.

## 2. Remove your existing thumb-latch.



Position your thumb-latch so that you can unscrew the existing screws on your deadbolt. Remove the screws entirely from the deadbolt and keep them to assist in the next step. After removing the screws, **be sure to unlock your deadbolt before removing the thumb-latch.**



Your thumb-latch may include an additional back plate underneath it. If so, remove the back plate, and use the back plate and the longer screws for the next step.





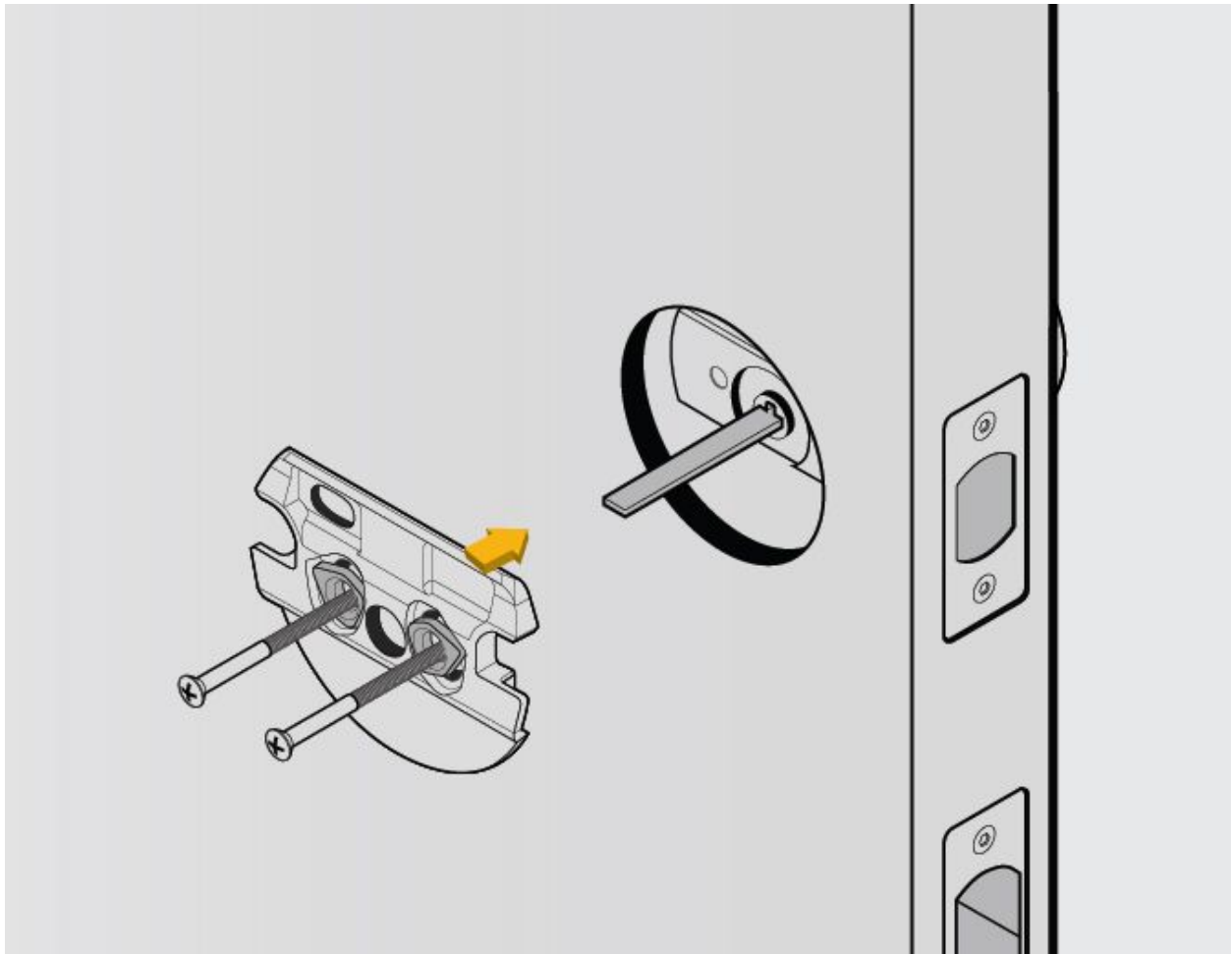



### **3. Position and attach the mounting plate.**

The included mounting plate has two adjustable screw-holes that can be repositioned as needed.



Remove the screws from the thumb-latch and insert them into the **front** of the mounting plate (the back of the mounting plate is flat and includes 4 pre-attached rubber bumpers). Use the screws to install the mounting plate over the existing deadbolt tailpiece. Moderately tighten the screws by hand until the mounting plate is settled against the door. **Do not over-tighten the screws** - over-tightening can deform the mounting plate and interfere with the operation of the lock.

#### 4. Select and attach the correct adapter.

BRAND	ADAPTER
Baldwin - Estate/Images*	
Baldwin Reserve/Prestige	
Defiant	
Emtek	
Kwikset*	
Omnia**	
Schlage***	
Weiser	
Weslock	

\* Baldwin and Kwikset Deadbolts installed before 1997 have unique installation requirements, please contact us at 844-AUGUST1 (284-8781) and we will walk you through installation.

\*\* Compatible only with non-mortise, standard Omnia deadbolts.

\*\*\* Commercial grade Schlage B560 deadbolts require supplemental screws. If your Schlage screws are too short please contact us at support@august.com

Select your adapter from the Compatibility Chart above.



(If your lock brand is **not** in the chart, slide each adapter onto the tailpiece to find the right one. **The correct adapter will have the small nub pointing up.**)

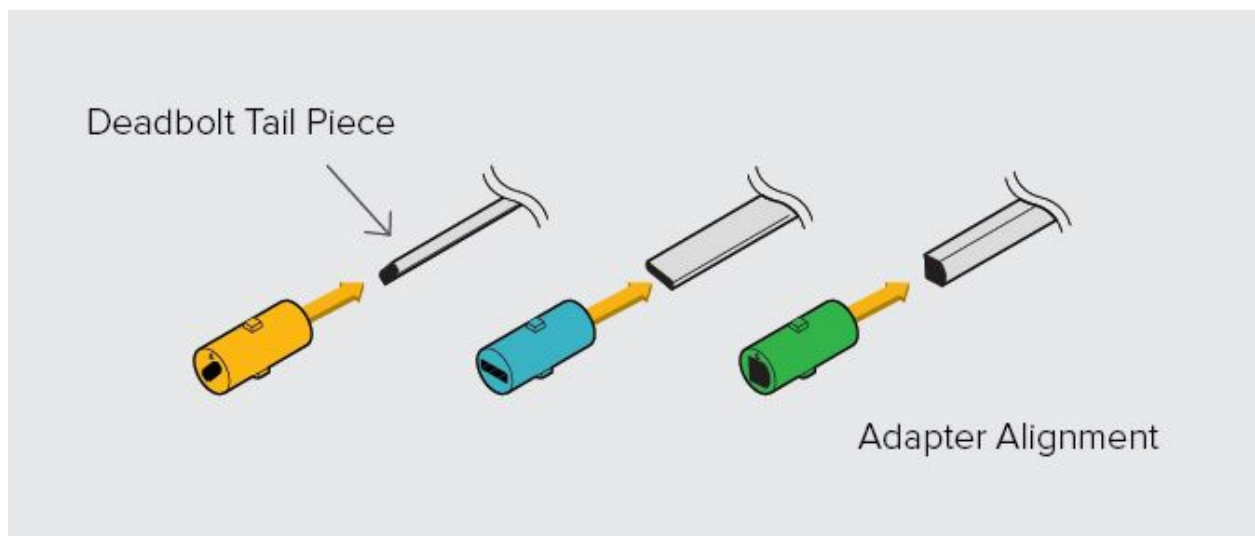
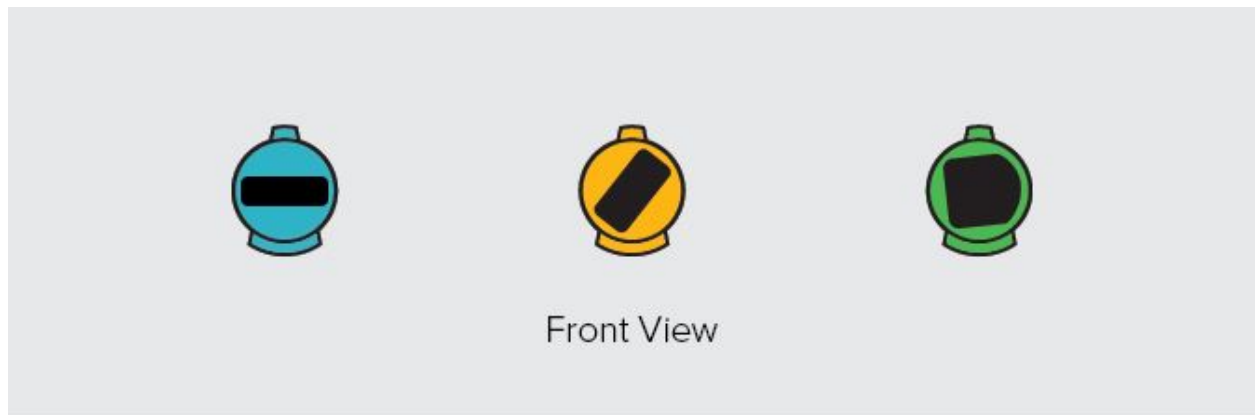

Place the correct adapter onto the tail piece with the small nub pointing up. Tighten the screws until they are moderately tight. **Do not over-tighten** - over-tightening can deform the mounting plate and interfere with the operation of the lock.

## 5. Attach the August Smart Lock.

Insert the adapter into the back of the August Smart Lock, then position the August Smart Lock with the August name badge at the top.

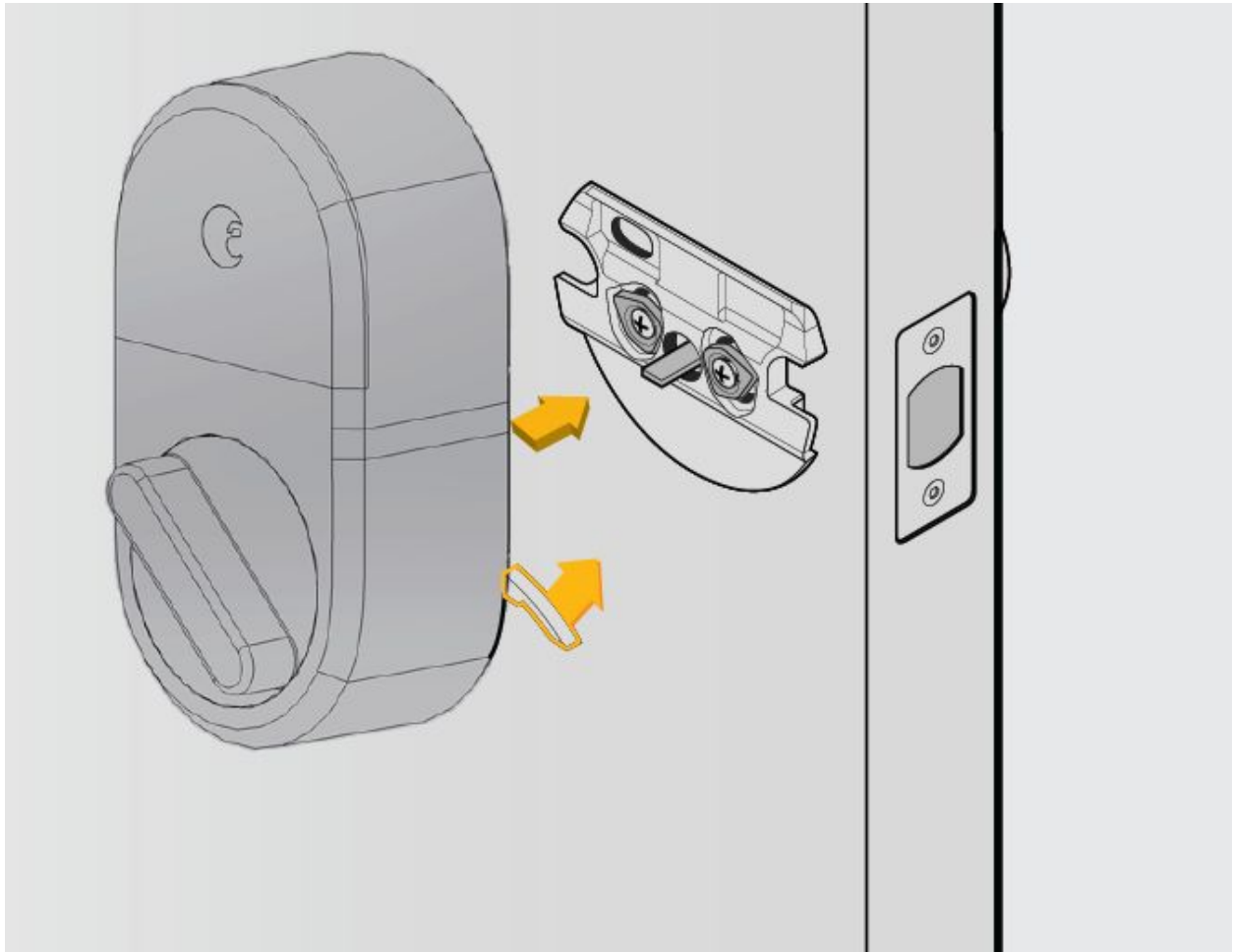

Pull out both side wing latches. Slide the August Smart Lock over the tailpiece and attach it to the mounting plate. **Make sure the back of the lock is flush with the door.**

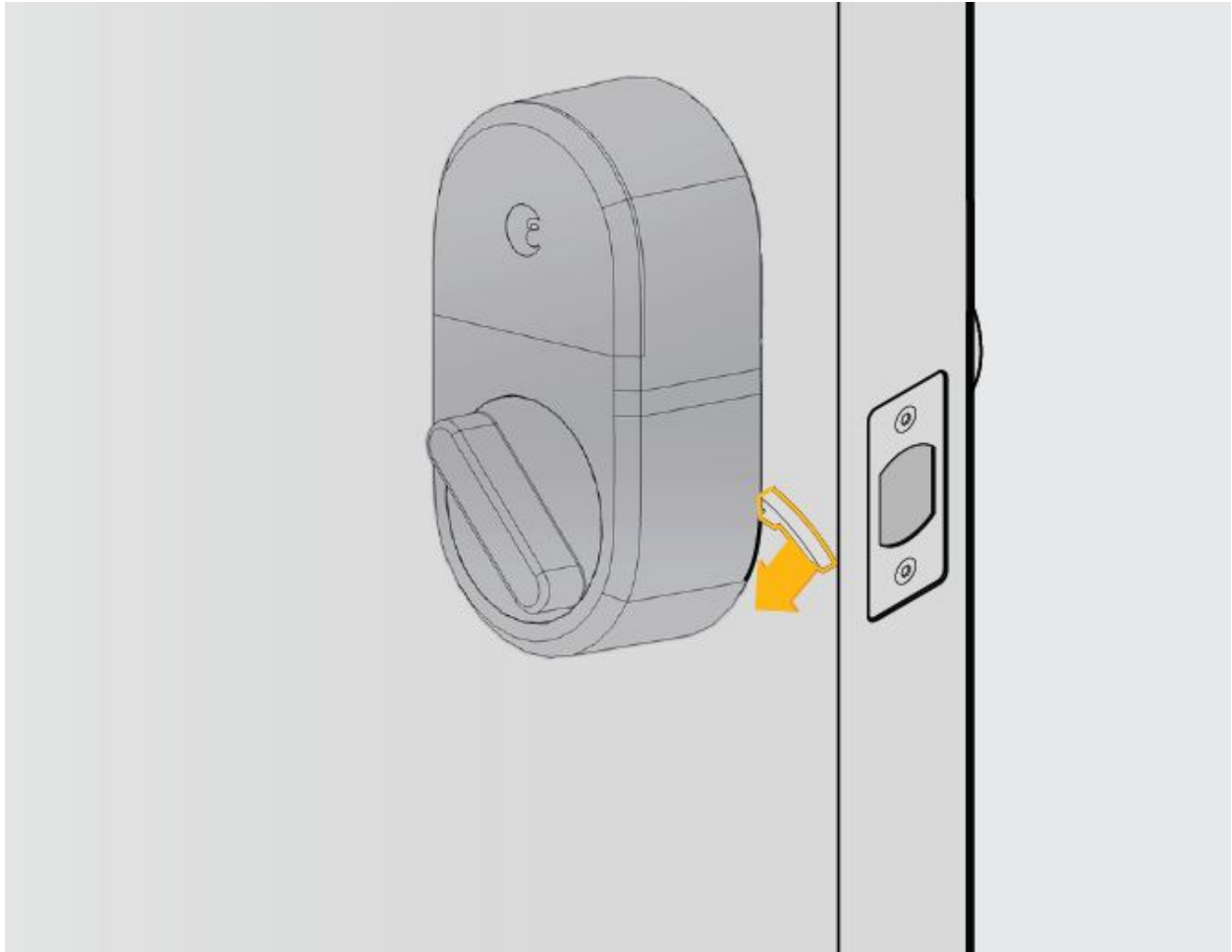

To secure the August Smart Lock, clamp down both side wing latches to the mounting plate completely. If the latches are difficult to clamp down, go back to the last paragraph of step 4 and **ensure that the screws have not been over-tightened**. If the wing latches won't clamp down properly, you may need to adjust the tightness of the screws.

**6. Use the August Home app to complete setup.**

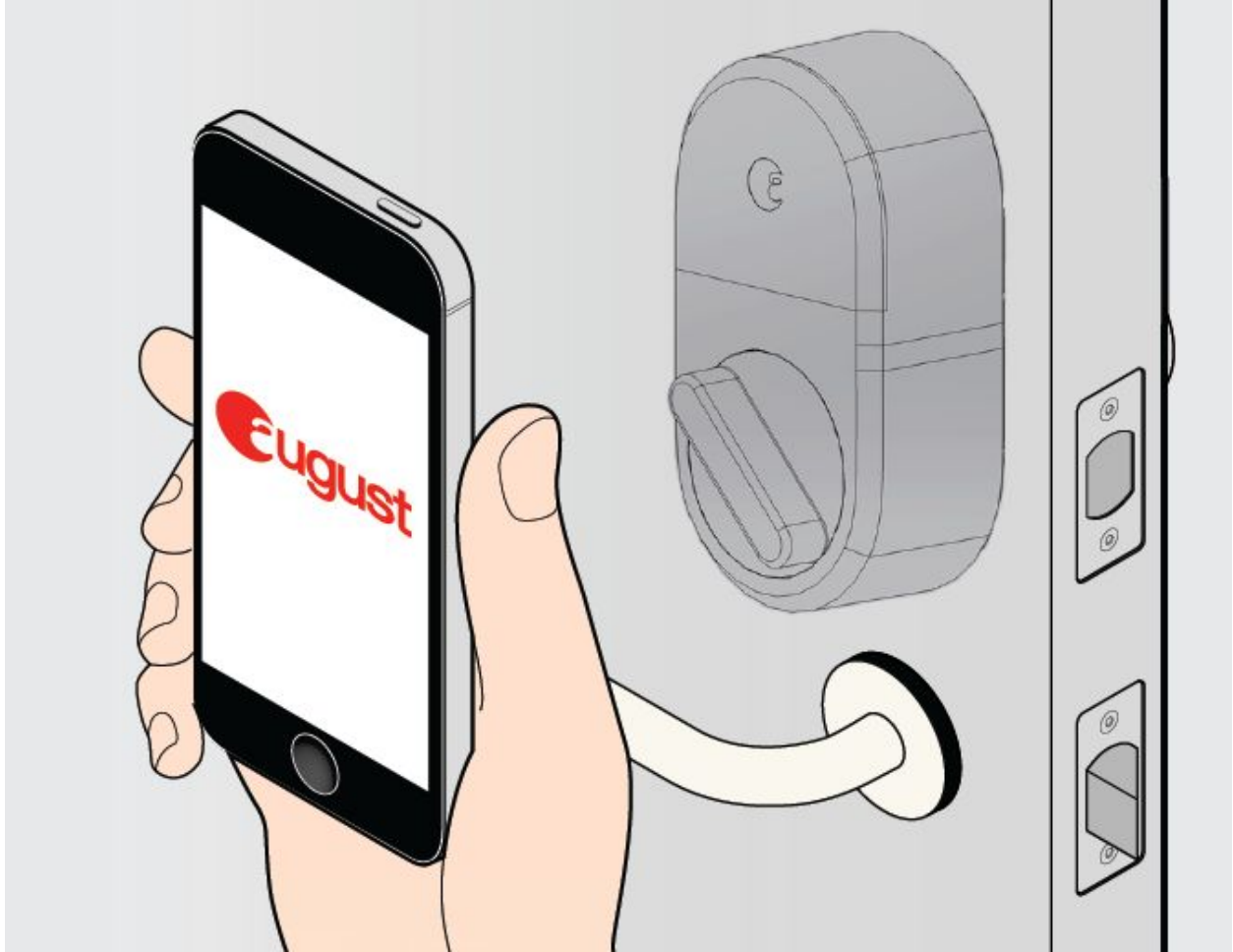

Download and install the August Home app. Select "Get Started" from the home screen, or, if already logged in to the app, select "Set Up a Lock" from the main menu.

# Safety

Risk of explosion and personal injury if batteries are replaced by incorrect type. Do not open, mutilate, or expose to conducting materials (metal), moisture, liquid, fire or heat above 54°C (130°F), incinerate, or immerse in water or liquid of any kind. Do not short circuit. Doing so may cause batteries to leak or explode, resulting in personal injury. Dispose of spent, leaking, or damaged batteries according to manufacturer instructions and local laws. Do not mix battery types. Do not charge alkaline batteries. Battery life varies with usage. When replacing, remove all spent batteries, and do not mix old batteries with new. When device is not in use for extended periods, remove batteries to avoid leakage and store away from children in a cool, dry place at room temperature.

**The August Smart Lock is not an ANSI or BHMA certified door lock and must be correctly installed and used with a certified door lock that is operating in good condition. You assume all risk associated with the suitability, installation and performance of the door lock and other third party components, hardware, software and services that you select.**

# Environmental

DIMENSIONS: 2.6" width x 4.44" height x 2.12" depth

DEVICE WEIGHT: 12.2 oz. (346 g)

CERTIFICATION: FCC, IC

OPERATING TEMP: 32° to 104° Fahrenheit  
(0° to 40°C)

STORAGE TEMP: -4° to 158° Fahrenheit  
(-20° to 70°C)

OPERATING HUMIDITY: 10 to 85%

# Compliance

## **FCC GENERAL STATEMENT**

This device complies with part 15 of the FCC Rules. Operation is subject to the following two conditions: (1) This device may not cause harmful interference, and (2) this device must accept any interference received, including interference that may cause undesired operation. Changes or modifications not expressly approved by the party responsible for compliance could void the user's authority to operate the equipment.

## **FCC Interference Statement for Class B devices**

This equipment has been tested and found to comply with the limits for a Class B digital device, pursuant to part 15 of the FCC Rules. These limits are designed to provide reasonable protection against harmful interference in a residential installation. This equipment generates, uses and can radiate radio frequency energy and, if not installed and used in accordance with the instructions, may cause harmful interference to radio communications. However, there is no guarantee that interference will not occur in a particular installation. If this equipment does cause harmful interference to radio or television reception, which can be determined by turning the equipment off and on, the user is encouraged to try to correct the interference by one or more of the following measures:

- Reorient or relocate the receiving antenna.
- Increase the separation between the equipment and receiver.
- Connect the equipment into an outlet on a circuit different from that to which the receiver is connected.
- Consult the dealer or an experienced radio/TV technician for help.

## **INDUSTRY CANADA COMPLIANT**

This device complies with Industry Canada license-exempt RSS standard(s). Operation is subject to the following two conditions: (1) this device may not cause interference, and (2) this device must accept any interference, including interference that may cause undesired operation of the device.

**INDUSTRIE CANADA CONFORME**

Le présent appareil est conforme aux CNR d'Industrie Canada applicables aux appareils radio exempts de licence. L'exploitation est autorisée aux deux conditions suivantes : (1) l'appareil ne doit pas produire de brouillage, et (2) l'utilisateur de l'appareil doit accepter tout brouillage radioélectrique subi, même si le brouillage est susceptible d'en compromettre le fonctionnement.

# Terms and Conditions





# Limited Warranty Statement

**IMPORTANT:** By using the August Smart Lock hardware (the "Device") you are agreeing to be bound by the terms of this Limited Warranty set forth below. If you do not agree to the terms of this Limited Warranty you may return the Device (in its original, unused condition) within thirty days of the date of purchase (or the return period provided by your place of purchase, whichever is longer) for a refund in accordance with our returns policy as set forth in Section 3 of this Limited Warranty.

This Limited Warranty gives you specific legal rights. You may also have other legal rights that vary by state, province or jurisdiction. The disclaimers, exclusions, and limitations of liability under this Limited Warranty will not apply to the extent prohibited by applicable law. For a full description of your legal rights you should refer to the laws applicable in your jurisdiction and you may wish to contact a relevant consumer advisory service.

## 1. Duration and Coverage.

One (1) year Limited Hardware Warranty. Subject to the additional terms and conditions set forth below, August provides the following Limited Warranty:

- Only to the person or entity that originally purchased the Device from August or from one of its authorized resellers or distributors; and
- Only for Devices purchased and delivered to the end user within the United States or Canada.

## 2. Limited Warranty.

August warrants the Device against defects in materials and workmanship under normal use for a period of one (1) year from the date of purchase ("Warranty Period"). If a Device is returned to August during the Warranty Period as provided below, and August determines that the Device is defective, August will either repair or replace the unit with either a new or a refurbished August Smart Lock. If the Warranty Period has expired or is otherwise not applicable as per the Scope and Limitation on Warranty (below), we will return the Device to you. More information about this warranty can be found at [www.august.com/support](http://www.august.com/support).

## 3. Return and Warranty Service Process.

Please review the online help resources at [www.august.com/support](http://www.august.com/support) prior to seeking warranty service. To obtain warranty service, you must first obtain a Return Merchandise Authorization (RMA) number from a Customer Support Representative (CSR) at August. Customer Support contact information can be found by visiting

[www.august.com/support](http://www.august.com/support). August may attempt to troubleshoot a warranty-related problem prior to issuing a RMA number. August may ask for additional information upon request. Issued RMA numbers remain valid for thirty days from issuance. Once an RMA number is obtained, your Device must be shipped freight prepaid; together with proof of purchase and all accessories, either its original packaging or packaging affording an equal degree of protection, to the August authorized distribution facility identified by the CSR. Failure to return any of the accessories may result in a delay and/or result in a credit to August or an invoice for the missing accessories.

In performing warranty service, August may furnish replacement parts on an exchange basis and replaced parts will become the property of August. Replacement parts provided by August shall be new or refurbished and of comparable quality, and may be a different part that contains compatible features and functions. You will reimburse August for the inspection, testing and repair of returned equipment determined by August not to be defective or which falls under one of the warranty exclusions described below (as well as pay all shipping and handling charges). In all cases, August's determination as to whether or not the equipment is defective and covered by warranty will be final. Any replacement equipment will be warranted hereunder for a period of one (1) year from shipment. August reserves the right to change the method by which August may provide warranty service to you, and your Device's eligibility to receive a particular method of service.

#### 4. Scope of and Limitation of Warranty.

The warranty on this Device is limited to the repair or replacement of defective Devices as described in the Limited Warranty section above. This warranty does not cover customer training and education, installation, set up or adjustment, signal or reception problems. The August Smart Lock is not an ANSI or BHMA certified door lock and must be correctly installed and used with a certified door lock that is operating in good condition. You assume all risk associated with the suitability, installation and performance of the door lock and other third party components, hardware, software and services that you select.

This warranty does not cover damage (i) due to acts of God, other forces beyond our reasonable control, such as internet or power outages, wars, riots, terrorism, labor disputes, earthquakes, floods or other events of "force majeure," accident, misuse, abuse, negligence, commercial use or modification of, or to any part of your Device; (ii) caused by any third party product, service or system, use of the Device for purposes other than for which the Device was designed or intended, or use in improper temperature, humidity or other environmental conditions, or use of the Device in violation of written instructions provided by August (which may be provided at the time of purchase or on its website at [www.august.com/support](http://www.august.com/support)). This warranty does not cover defects due to normal wear and tear or aging. This warranty does not cover damage due to improper repair, operation or maintenance or connections to improper voltage supply or, to the extent allowed by law, attempted repair by anyone other than a

facility authorized by August to service your August Device. This warranty does not cover consumable parts (such as batteries). This warranty gives you specific legal rights, and you may also have other rights which vary from state to state (and jurisdiction to jurisdiction).

#### 5. Disclaimer of Warranties.

TO THE EXTENT PERMITTED BY LAW, THIS WARRANTY AND THE REMEDIES SET FORTH ARE EXCLUSIVE AND IN LIEU OF ALL OTHER WARRANTIES, REMEDIES AND CONDITIONS, WHETHER ORAL, WRITTEN, STATUTORY, EXPRESS OR IMPLIED. AUGUST DISCLAIMS ALL STATUTORY AND IMPLIED WARRANTIES, INCLUDING WITHOUT LIMITATION, WARRANTIES OF MERCHANTABILITY AND FITNESS FOR A PARTICULAR PURPOSE AND WARRANTIES AGAINST HIDDEN OR LATENT DEFECTS, TO THE EXTENT PERMITTED BY LAW. IN SO FAR AS SUCH WARRANTIES CANNOT BE DISCLAIMED, AUGUST LIMITS THE DURATION AND REMEDIES OF SUCH WARRANTIES TO THE DURATION OF THIS EXPRESS WARRANTY AND, AT AUGUST'S OPTION, THE REPAIR OR REPLACEMENT SERVICES DESCRIBED ABOVE. SOME STATES (COUNTRIES AND PROVINCES) DO NOT ALLOW LIMITATIONS ON HOW LONG AN IMPLIED WARRANTY (OR CONDITION) MAY LAST, SO THE LIMITATION DESCRIBED ABOVE MAY NOT APPLY TO YOU.

#### 6. Limitation of Damages.

IN ADDITION TO THE ABOVE WARRANTY DISCLAIMERS, TO THE MAXIMUM EXTENT PERMITTED BY LAW, NEITHER AUGUST NOR ITS SUPPLIERS SHALL BE RESPONSIBLE OR LIABLE WITH RESPECT TO ANY SUBJECT MATTER OF THIS AGREEMENT OR TERMS OR CONDITIONS RELATED THERETO UNDER ANY BREACH OF CONTRACT, NEGLIGENCE, STRICT LIABILITY OR ANY OTHER THEORY (A) FOR LOSS OR INACCURACY OF DATA OR COST OF PROCUREMENT OF SUBSTITUTE GOODS, SERVICES OR TECHNOLOGY, OR (B) FOR ANY INDIRECT, INCIDENTAL OR CONSEQUENTIAL DAMAGES INCLUDING, BUT NOT LIMITED TO BUSINESS INTERRUPTION, LOSS OF REVENUES AND LOSS OF PROFITS. THE FOREGOING SHALL APPLY EVEN IF AUGUST HAS BEEN ADVISED OF THE POSSIBILITY OF SUCH DAMAGES. TO THE MAXIMUM EXTENT PERMITTED BY LAW, AUGUST'S AGGREGATE CUMULATIVE LIABILITY HEREUNDER SHALL NOT EXCEED THE ORIGINAL PURCHASE PRICE PAID FOR THE DEVICE THAT CAUSED SUCH DAMAGE. CERTAIN STATES (COUNTRIES AND PROVINCES) DO NOT ALLOW THE LIMITATION OF LIABILITY FOR INCIDENTAL OR CONSEQUENTIAL DAMAGES, SO THE EXCLUSIONS SET FORTH ABOVE MAY NOT APPLY TO YOU.

# Specifications

MODEL NAME: August Smart Lock

DESCRIPTION: BLE Automatic Smart Lock

MODEL NUMBER: ASL-3B

STANDARDS: Bluetooth Specification v4.0 (Bluetooth Smart), 2.4GHz ISM band

ANTENNA: Internal Single-band (Internal IFA) Transmitted

The Bluetooth® word mark and logos are registered trademarks owned by Bluetooth SIG, Inc. and any use of such marks by August Home, Inc. is under license. Other trademarks and trade names are those of their respective owners.

Android is a trademark of Google Inc.