



beamit

QUICK START GUIDE

CONTENTS

Welcome	2
In the Box	3
Keys and Parts	4
Features	5
Getting Started	6
Setup: Connecting in TX Mode Connecting to a TV or Computer	7
Setup: Pairing in TX Mode Pairing with a Bluetooth Headphone / Speaker Multi-point Streaming: Pairing with two Bluetooth Headphones	9
Setup: Connecting in RX Mode Connecting to a Home stereo system / Powered speakers	11
Setup: Pairing in RX Mode Pairing with a Smartphone / Tablet / Computer	13
Other Functions	14
Troubleshooting Tips	15
Technical Specifications	18
Product Safety	20
Safety Instructions	21
Warranty	22

WELCOME!

Congratulations on your purchase of the auris **beamit** Wireless Bluetooth® Audio Transmitter & Receiver!

The following pages explain the features and operations of **beamit**. Please take a few moments to read this quick start guide.

Also read all safety instructions before proceeding. The answers to most set up and performance questions can be found in this guide. If you have any further questions about the operation or use of this product, please contact our customer care team for assistance on support@theauris.com

Overview

beamit is a sleek and compact Bluetooth® audio transmitter that seamlessly streams Hi-Fi digital audio wirelessly from your TV or wired music system to your favorite pair of Bluetooth headphones or speakers.

Also it's a Hi-Fi Bluetooth music receiver that streams high quality audio wirelessly from any Bluetooth enabled smartphone, computer or tablet to any music system or powered speakers.

Incorporating the high quality aptX® LOW LATENCY audio streaming codec and digital TOSLINK connection, beamit provides Hi-Fi digital audio streaming to up to two Bluetooth headphones or speakers simultaneously.

IN THE BOX

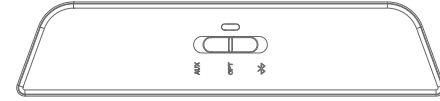

beamit

Wireless Bluetooth® Audio Transmitter & Receiver

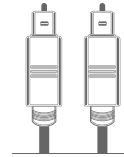

TOSLINK Optical
Audio Cable

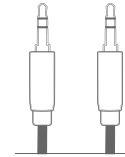

3.5mm AUX
Audio Cable

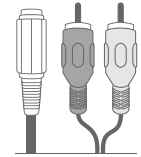

3.5mm to RCA
Adapter



USB Power
Adapter

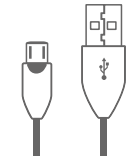

Micro - USB
Charging Cable

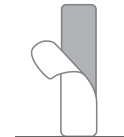

Sticky Gel
Mounting Strip



Quick
Start Guide

KEYS AND PARTS

Front Panel

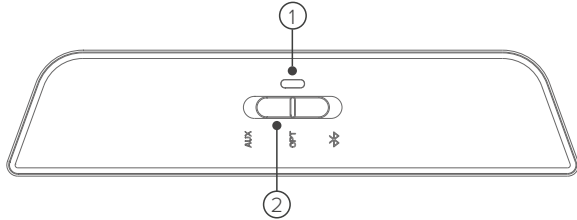

Rear Panel

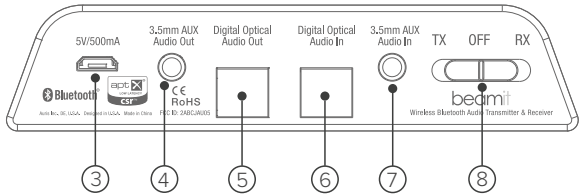

- ① LED Indicator
- ② Multifunction Switch (MFS) - Audio Source Select / Pairing
- ③ Micro USB power input
- ④ 3.5mm AUX Audio Out
- ⑤ Toslink Optical Audio Out
- ⑥ Toslink Optical Audio In
- ⑦ 3.5mm AUX Audio In
- ⑧ TX / RX toggle and Power OFF switch

FEATURES

beamit is an audio adapter which can be used in two ways: as a stereo wireless Transmitter or Receiver, using Bluetooth® wireless technology.

As a Transmitter (TX mode)

In TX mode, **beamit** can wirelessly stream audio from a non-Bluetooth device (HDTV / Computer) to any Bluetooth audio receiver that supports the A2DP Bluetooth profile, such as a Bluetooth headphone, Bluetooth speaker, or dedicated A2DP receiver.

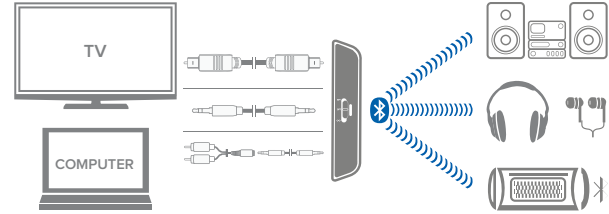

As a Receiver (RX mode)

In RX mode, **beamit** enables wireless audio streaming from any Bluetooth enabled smartphone, computer or tablet to any non-Bluetooth music system or powered speakers.

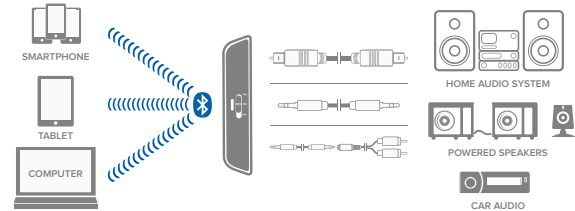

GETTING STARTED

The following instructions will help you get started before connecting **beamit** to your devices.

Step 1: Stick one side of the included double sided sticky gel mounting strip to the bottom of **beamit**. Mount **beamit** on to the side or top of your TV or audio system.

*Avoid placing **beamit** behind the TV or any audio device.*

Step 2: Plug the included Micro - USB charging cable into the USB power adapter / any powered USB port** and the charging port on the rear of the unit.

Step 3: Select your choice of mode (TX / RX) by sliding the toggle switch situated on the rear of **beamit**. The LED light will start flashing indicating the unit is switched “ON”.

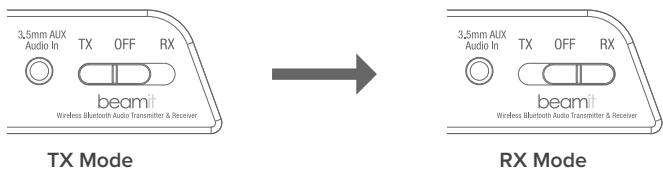

To switch off **beamit**, slide the TX / RX toggle switch to the “OFF” position.

***The USB outputs of some TVs do not provide a stable current. It is recommended to use a USB power adapter to power **beamit**.*

SETUP: CONNECTING IN TX MODE

Connecting to a TV or Computer

AUDIO INPUTS are used with TX MODE ONLY – When in TX mode **beamit** needs an audio source to transmit. It must be fed an audio signal from a connected device such as a television, video game system, computer, mp3 player, etc.

The following instructions will help you connect **beamit** to your TV or computer and pair with your Bluetooth headphones, speakers or receivers.

beamit provides three connection options.

Option 1: Digital Optical Audio Out (TOSLINK)

Newer TV's are usually outfitted with a TOSLINK digital optical connector.

Plug the included fiber optic TOSLINK cable firmly into the “OPTICAL AUDIO OUT” on the TV and the “OPTICAL AUDIO IN” of **beamit**.

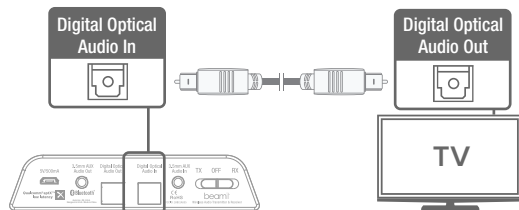

If you have successfully connected the TOSLINK cable and you are still not receiving any sound, please make sure that your audio output settings on your TV or other relevant device are set to PCM.

SETUP: PAIRING IN TX MODE

Option 2: RCA Audio Out

Older TVs usually have analog audio output with RCA (Red & White) connectors.

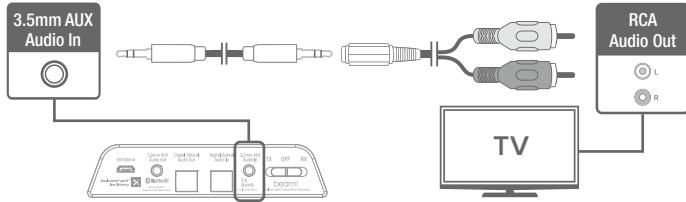

Attach the included RCA adapter to the 3.5mm stereo audio cable. Plug the connectors of the RCA adapter into the matching-color RCA jacks on the TV and plug the attached 3.5mm cable into the “3.5mm AUX AUDIO IN” on the rear of [beamit](#).

Option 3: 3.5mm Headphone jack

Some TVs and most standalone receivers have a headphone jack on the front or side.

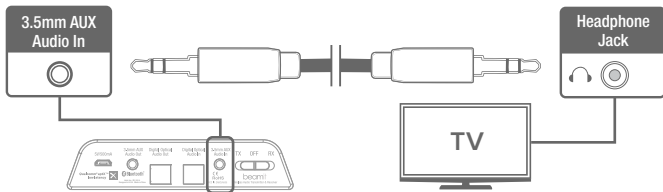

Plug the included 3.5mm stereo audio cable into the headphone jack on the TV and the “3.5mm AUX AUDIO IN” on [beamit](#).

Pairing with a Bluetooth Headphone / Speaker

The following instructions will help you in pairing [beamit](#) with your Bluetooth headphone or speaker in Transmit Mode (TX) after connecting [beamit](#) to your TV or computer.

Step 1: Follow the previous instructions and connect [beamit](#) to your TV using the appropriate connector cable.

Step 1: Place your Bluetooth headphone or speaker within 1 meter (3 feet) range of [beamit](#) and set it to pairing mode.

Step 2: With [beamit](#) powered on and TX / RX toggle switch set to “TX”, slide and hold the spring-loaded slider (Multi-Function Switch) all the way to the right. The blue LED indicator light will blink rapidly to indicate that [beamit](#) is ready to pair. Release the spring-loaded slider.

Step 3: [beamit](#) and your bluetooth headphone or speaker have to be in pairing mode simultaneously in order to pair. [beamit](#) will remain in pairing mode for 30 seconds or until successfully paired. Once paired, the blue light will turn solid blue.

Step 4: Make sure the proper audio input source is selected on [beamit](#). Match the corresponding audio input on the back of [beamit](#) by selecting between Optical and AUX mode using the Multi-Function Switch.

Step 5: The sound from your TV will now play through your Bluetooth headphone or speaker!

Multi-Point Streaming - Pairing with Two Bluetooth Headphones

In TX mode, **beamit** can stream audio to two Bluetooth headphones simultaneously. A second headphone can be paired after one headphone is already connected.

Step 1: Connect your first headphone with **beamit** by following the previous pairing instructions.

Step 2: Get **beamit** in pairing mode - slide and hold the the spring-loaded slider (Multi-Function Switch) till the LED indicator blinks rapidly.

Step 3: Set your second headphone to pairing mode and wait until they connect.

Step 4: The sound from your TV will now play through both the Bluetooth headphones simultaneously!

Note: **beamit** will provide the best possible audio quality and minimize audio latency only when used with headphones or receivers that support Qualcomm aptX® Low Latency technology. When streaming to two headphones, if one of the headphones supports aptX® and the other does not then standard Bluetooth audio streaming will be used with both headphones.

SETUP: CONNECTING IN RX MODE

Connecting to a Home Stereo System or Powered Speakers

AUDIO OUTPUTS are used with RX MODE ONLY – When in RX mode **beamit** is receiving an audio signal and passing that signal from its output to the input of some type of amplification device like a home stereo, bookshelf speaker, car audio, etc.

The following instructions will help you connect **beamit** to your stereo system or bookshelf speakers and pair with your tablet, computer or smartphone.

beamit provides three connection options.

Option 1: Digital Optical Audio In (TOSLINK)

Home theater systems, receivers and newer stereo systems are outfitted with a TOSLINK digital optical connector.

Plug the included fiber optic TOSLINK cable firmly into the “OPTICAL AUDIO IN” on the music system and the “OPTICAL AUDIO OUT” of **beamit**.

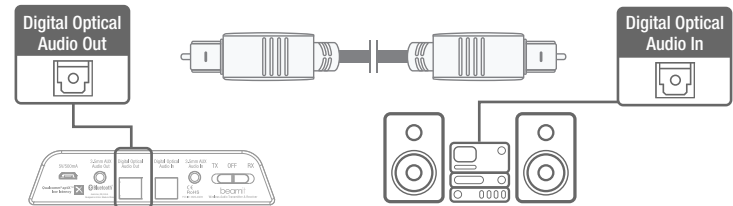

SETUP: PAIRING IN RX MODE

Pairing with a Smartphone / Tablet / Computer

The following instructions will help you in pairing beamit with your smartphone, tablet or computer in Receiver Mode (RX) after connecting beamit to your home stereo system or powered speakers.

Step 1: Follow the previous instructions and connect beamit to your music system using the appropriate connector cable.

Step 2: With beamit powered on and the TX/RX toggle switch set to “RX”, slide and hold the spring-loaded slider (Multi-Function Switch) all the way to the right. The blue LED indicator light will blink rapidly to indicate that beamit is ready to pair. Release the spring-loaded slider.

Step 3: Turn ON Bluetooth on your device and go to Bluetooth preferences.

Step 4: Scan listed Bluetooth devices and select “auris beamit” to pair and connect. Once paired, the LED indicator will turn solid blue.

Step 5: Make sure the proper audio output source is selected on beamit. Match the corresponding audio output on the back of beamit by selecting between Optical and AUX mode using the Multi-Function Switch.

Step 6: The music on your smart device will now play through your home stereo system / speakers!

Option 2: RCA (Red & White) Connectors

Older or legacy stereo systems and receivers usually have analog audio output with RCA (Red & White) connectors.

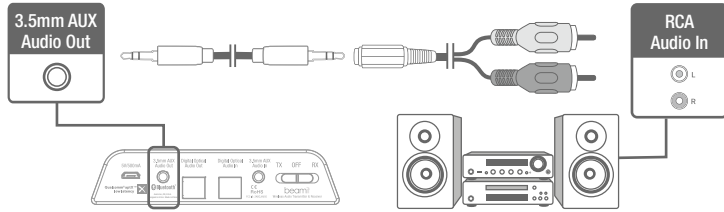

Attach the included RCA adapter to the 3.5mm stereo audio cable. Plug the connectors of the RCA adapter into the matching-color RCA jacks on the music system and plug the attached 3.5mm cable into the “3.5mm AUX AUDIO OUT” on the rear of beamit.

Option 3: 3.5mm Headphone jack

Most powered or bookshelf speakers have a headphone jack.

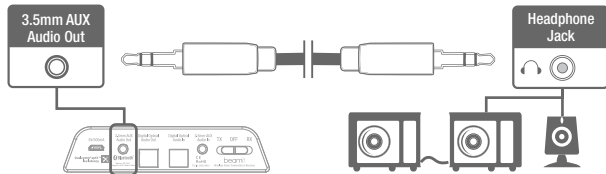

Plug the included 3.5mm stereo audio cable into the headphone jack on the TV and the “3.5mm AUX AUDIO OUT” on beamit.

OTHER FUNCTIONS

Reconnection

Previously paired bluetooth devices will reconnect to beamit automatically once turned back on. beamit will not initiate reconnection. If beamit itself is turned off, it is recommended to turn it back on first before turning on the paired devices so that it can accept the incoming Bluetooth connection from the devices.

Adjusting the Volume

beamit, by design, is a passive transmitter or receiver and has no volume control. User volume level must be adjusted via the input and output sources connected to beamit.

Volume can be individually adjusted on each set of headphones paired with beamit using the built-in volume controls on the headphone. With some TVs and connection options, TV volume may be further raised or lowered to change the volume of all headphones paired with beamit. In this case, volume should be maximized on the TV and then adjusted via headphones for best audio quality.

Factory Reset

In standby mode, slide and hold the spring-loaded slider (Multi-Function Switch) all the way to the right for approximately 5 seconds until the blue indicator light begins to blink. Release the spring-loaded switch. The unit will enter pairing mode and any previously paired devices will be cleared from memory.

TROUBLESHOOTING TIPS

beamit is connected but it will not turn on - LED indicator does not light up.

Confirm that the power adapter is connected to beamit with the included USB cable and plugged into a functioning AC outlet. The blue LED indicator on the front of the unit will light up when the unit is turned "ON" by setting the TX/RX toggle switch on the rear of the unit to "TX or RX".

Unable to pair and connect beamit to my Bluetooth device.

Make sure you are operating beamit in the appropriate Bluetooth mode.

In TX Mode: beamit can only pair with a Bluetooth receiving device such as a Bluetooth headphone, speaker or receiver. In this mode, ensure that beamit and the Bluetooth headphone, speaker or receiver are in pairing mode at the same time and are within 1 meter (3 feet) of each other.

In RX Mode: beamit can only pair with a Bluetooth transmitting device such as a smartphone, tablet or computer. In this mode, ensure that Bluetooth is turned 'ON' on your smartphone, tablet or computer. Make sure that the LED indicator is blinking and your device and beamit are within 1 meter (3 feet) of each other.

My Bluetooth headphone is connected but there is no audio output.

1. Ensure that your audio source (TV/computer) OUTPUT is properly connected to beamit audio INPUT. Audio inputs are used with TX MODE only.
2. Check whether the audio input is correctly selected on beamit (AUX ↔ OPT). If AUX is selected, make sure make sure your audio source is connected to the AUX input. If OPT is selected, make sure your audio source is connected to the Optical input.
3. Confirm that audio is playing on the TV/computer and the volume is set to "High" on the TV/computer. Make sure that volume is sufficiently high on your Bluetooth headphone / speaker.

4. If you are using an Optical connection, make sure nothing is connected to the AUX input of **beamit**.

Smartphone is connected but cannot hear any sound from my audio system.

1. Ensure that your audio source (Home audio system, stereo speakers, etc.) INPUT is properly connected to **beamit** audio OUTPUT. Audio outputs are used with RX MODE only.

2. Check whether the audio output is correctly selected on **beamit** (AUX ↔ OPT). If AUX is selected, make sure your audio source is connected to the AUX output. If OPT is selected, make sure your audio source is connected to the Optical output.

3. Verify the volume levels on your computer OS and player app.

4. If you are using an Optical connection, make sure nothing is connected to the AUX output of **beamit**.

The volume output level is Low.

In TX mode: Adjust the volume both on your Bluetooth headphones / speakers and on the TV or other connected device as both may control the volume.

In RX mode: Verify the volume levels on your smartphone / computer OS and player app. Also check the volume levels on your powered speakers or stereo system.

The sound quality is poor and / or the audio is cutting out.

1. For the most noise-free audio, maximize the volume on your audio source (TV, home audio system, powered speakers, etc.) and adjust volume via the Bluetooth enabled headphones, speakers or smartphone.

2. Make sure you are within range of your Bluetooth-enabled device.

3. Bluetooth devices are susceptible to interference from other Bluetooth devices, cordless phones, routers, microwave ovens, and wireless devices operating on the 2.4 GHz band. Eliminate as many potential sources of interference as possible while using your Bluetooth headphones / speakers.

There is a delay (latency) in audio

1. Bluetooth is a digital wireless signal and there is some latency expected due to the coding/decoding and compression/decompression steps that must occur.

2. The aptX® and aptX® Low Latency audio codecs supported by **beamit** are notable for having lower and much lower latency (smaller delay), respectively, compared to regular Bluetooth audio.

3. Using **beamit** with a headphone that supports aptX® or aptX® Low Latency will minimize audio lag.

4. Some modern TV's and receivers also have an audio delay option. Make sure that audio delay is set to 0 to minimize lag.

If you have any further queries please contact us on support@theauris.com

TECHNICAL SPECIFICATIONS

Bluetooth® Version	4.1 with aptX® Low Latency
Supported Codecs	aptX® Low Latency, aptX®, AAC, SBC
Bluetooth® Profiles	A2DP
Bluetooth® Range	Up to 10 meters, 33 feet
Outputs	TOSLINK Digital Optical Input & Output 3.5mm AUX Input & Output
Input Power	5V DC, 500 mA
Latency	~40 milliseconds (ms)
Mounting Options	Sticky Gel mounting strips
Included Accessories	TOSLINK Digital Optical Audio Cable 3.5mm AUX Audio Cable 3.5mm - RCA Adapter USB-microUSB Charging Cable USB Power Adapter Sticky Gel Mounting Strips Quick Start Guide

Dimensions	Height	0.94 inches (24 mm)
	Width	4.30 inches (109 mm)
	Depth	1.02 inches (26 mm)
	Weight	0.9 ounces (25 grams)

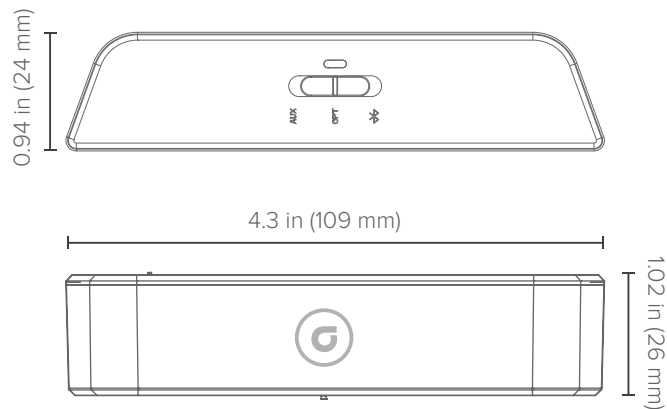

Weight: 0.9 oz (25 g)

PRODUCT SAFETY

When used in the directed manner, this unit has been designed and manufactured to ensure your personal safety. Improper use of this product can result in potential electrical shock or fire hazards. Please read all safety and operating instructions carefully before installation and use. Keep these instructions handy for future reference.



CAUTION: To reduce the risk of electric shock do not remove cover (or back). No user-serviceable parts inside. Refer servicing to qualified service personnel.

Users of this product are cautioned not to make modifications or changes that are not approved by Auris, Inc. Doing so may void the compliance of this product and may result in the loss of the user's authority to operate the equipment.

SAFETY INSTRUCTIONS

- Keep product dry to avoid affecting the interior circuitry of the product.
- Don't put the product in direct sunlight or place in hot areas.
- High temperature will shorten the life of electronic device.
- Don't expose to extreme temperatures, it may damage the internal circuit board.
- Don't take the product apart or the warranty will be voided.
- Don't drop the product.
- Don't use chemical or detergent to clean the product.
- Due to isolating characteristic of the product, do not use the product at excessive volume while driving or in any other activity where failure to hear surrounding sounds could be dangerous.
- Using the product at excessive volumes may cause permanent hearing damage. You can get the most out of your equipment and enjoy great audio performance even at safe levels.

WARRANTY

Don't worry. Your auris **beamit** is covered under our warranty. For warranty information please visit:

www.theauris.com/warranty

FCC Compliance

This device complies with Part 15 of the FCC Rules. Operation is subject to the following two conditions:

- (1) This device may not cause harmful interference, and
- (2) This device must accept any interference received, including interference that can cause undesired operation.

Any changes or modifications to the device will void the user's authority to operate the device.

This device complies with FCC radiation exposure limits set for an uncontrolled environment. This device should be installed and operated with minimum distance of 20cm between the radiator and the body.



FCC ID: 2ABCJAU05



The Bluetooth® word mark and logos are registered trademarks owned by Bluetooth SIG, Inc. and any use of such marks by Auris, Inc. is under license. Other trademarks and trade names are those of their respective owners.



Qualcomm® aptX™ is a product of Qualcomm Technologies International, Ltd. Qualcomm is a trademark of Qualcomm Incorporated, registered in the United States and other countries, used with permission. aptX is a trademark of Qualcomm Technologies International, Ltd., registered in the United States and other countries, used with permission.



auris and its logo are registered trademarks of Auris, Inc. All rights reserved.

Auris, Inc.
DE 19958, USA

www.theauris.com
support@theauris.com