



**Dynamic series**  
user manual





**Dynamic series**  
user manual



## INDEX

<b>1</b>	<b>User manual</b> .....	<b>3</b>
1.1	General instructions .....	3
1.2	Symbol conventions .....	4
<b>2</b>	<b>Documentation</b> .....	<b>5</b>
2.1	Battery charger manual .....	5
2.2	Technical data sheet .....	5
2.3	Guarantee .....	5
<b>3</b>	<b>Dynamic series description</b> .....	<b>6</b>
3.1	Conformity .....	6
3.2	Applications .....	7
3.3	Radio link .....	7
3.4	Frequencies .....	8
3.5	Classification of commands .....	8
3.6	Safety functions .....	9
3.7	Dynamic series technical data .....	10
3.8	Identifying the radio remote control .....	11
<b>4</b>	<b>Risk analysis</b> .....	<b>13</b>
4.1	Risk analysis for radio remote controlled machines .....	13
4.2	Working conditions .....	14
<b>5</b>	<b>FJS transmitting unit</b> .....	<b>15</b>
5.1	Description .....	15
5.2	Technical data .....	15
5.3	Light signals .....	16
<b>6</b>	<b>FJL transmitting unit</b> .....	<b>18</b>
6.1	Description .....	18
6.2	Technical data .....	18
6.3	Light signals .....	19
<b>7</b>	<b>FJM transmitting unit</b> .....	<b>20</b>
7.1	Description .....	20
7.2	Technical data .....	21
7.3	Light signals .....	21
<b>8</b>	<b>CRS receiving unit</b> .....	<b>23</b>
8.1	Description .....	23
8.2	Technical data .....	24
8.3	Light signals .....	24
<b>9</b>	<b>Warnings for installation</b> .....	<b>26</b>
9.1	General .....	26
9.2	Mounting and fastening the receiving unit in the best position .....	26
9.3	Mounting and fastening the antenna in the best position .....	26
9.4	Wiring .....	26
9.5	At end of installation .....	27

9.6 Testing .....	27
<b>10 Warnings for use .....</b>	<b>28</b>
10.1 Before starting to work .....	28
10.2 During normal operation .....	28
10.3 After using the radio remote control .....	29
<b>11 Radio remote control lifecycle .....</b>	<b>30</b>
11.1 Transportation and storage .....	30
11.2 Installation .....	30
11.3 Use .....	31
11.4 Maintenance .....	31
11.5 Machine maintenance .....	34
11.6 Disposal .....	34
<b>12 General operating instructions .....</b>	<b>35</b>
12.1 Starting up the radio remote control .....	35
12.2 Command activation .....	35
12.3 Data Feedback Function .....	35
12.4 Automatic interruption of the radio link .....	36
12.5 Transmitting unit automatic switch off .....	36
12.6 Switching off the transmitting unit .....	37
12.7 Switching off the receiving unit .....	37
<b>13 Working .....</b>	<b>38</b>
13.1 BATTERY .....	38
13.2 S-KEY .....	38
13.3 START pushbutton .....	39
13.4 STOP .....	39
13.5 Command meaning .....	40
13.6 Low Power function .....	41
13.7 Wire control .....	41
<b>14 Troubleshooting .....</b>	<b>43</b>
14.1 Radio remote controls with Data Feedback function .....	43
14.2 Radio remote controls with wire control .....	43
14.3 Solutions in case of malfunction .....	44

The documentation enclosed with the user manual of Dynamic series radio remote controls always consists at least of:

- battery charger manual
- technical data sheet
- guarantee booklet and its related validation slip.

When purchasing a radio remote control, make sure that all the following documents are supplied: if they are not, please ask for a copy from Autec, reporting the radio remote control serial number (S/N).

The documentation must be kept for the whole life of the radio remote control: after reading it, keep it on hand for future reference.

## **AUTEC - Dynamic Series**

User manual

## 1 User manual

---

This manual is intended for Autec Dynamic series radio remote controls.

It contains warnings, information and instructions for:

- FJS, FJL and FJM transmitting units
- CRS receiving units



FJS transmitting unit

FJL transmitting unit

FJM transmitting unit

CRS receiving unit

### 1.1 General instructions

---

This manual is an integral part of the radio remote control and it aims at providing the instructions needed for using and maintaining the system, with an eye on its safety functions.

Always remember that:

- photos and drawings in this manual are useful examples that help understand the instructions and warnings of each radio remote control configuration
- if necessary, contact Autec if any of the instructions and/or warnings given in this manual are not clear.

No part of this manual may be reproduced, in any form or by any means, without written permission of Autech (including recording and photocopying).  
If this manual is lost or damaged, ask Autech for a copy. Please specify the serial number of the related radio remote control.

Information contained in this manual adds to and completes the information provided by the manufacturer of the remote controlled and/or by those who install the radio remote control on the machine.

All installation, usage and maintenance operations must be carried out by qualified technicians who are suitably trained with respect to the relevant norms and laws.

Therefore, this manual must be read and understood in all its parts by the user and by:



- the radio remote control owner and/or installer
- the person responsible for and in charge of maintenance and/or safety in the workplace where the radio remote control is used

As for instructions and warnings regarding the machine where the radio remote control is installed, follow the instructions given in the machine's manual.

## 1.2 Symbol conventions

---

Three symbols are employed in this manual, which are used to highlight specific safety-related issues. They are classified according to the hazardous situation that may arise and on the possible consequences:

Symbol	If the highlighted instructions are not respected, this leads to hazardous situations with the following characteristics:		
	dangerous situation	gravity of consequences for people	gravity of consequences for property
 DANGER	...highly probable.	...critical (death or physical damage).	...critical.
 WARNING	...probable.	...critical (death or physical damage).	...critical.
 CAUTION	...probable.	... moderate (non-severe physical damage).	...moderate.



This symbol is also used, and it identifies texts to be read carefully.



## 2 Documentation

---

### 2.1 Battery charger manual

---

The battery charger manual contains instructions and warnings for a correct use of the battery charger and of batteries.  
It is included in the battery charger package.

### 2.2 Technical data sheet

---

The technical data sheet contains the transmitting unit configuration and shows the matching between commands sent and machine functions/movements.  
It also contains the wiring diagram showing the connection between the receiving unit and the machine.

The technical data sheet must be filled in, checked and signed by the installer, who is responsible for a correct wiring.  
The technical data sheet must be kept together with this manual (always keep a copy of this data sheet for administrative purposes).



**The wiring of the receiving unit outputs must always reflect the wiring indicated in the technical data sheet.**

### 2.3 Guarantee

---

Guarantee terms and conditions for the radio remote control are stated in the related booklet.

### 3 Dynamic series description

---

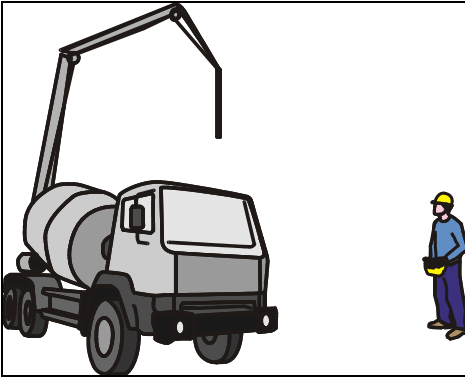

Autec Dynamic series industrial radio remote controls are used to control machines from a distance, without physical connections (i.e. wires or connecting cables) between the user and the machine. Each of these industrial radio remote controls consists of a portable transmitting unit, from which the user can remotely control the machine, and a receiving unit installed on board the machine itself.

#### 3.1 Conformity

---

Dynamic series radio remote controls working within the frequency band 915 - 928 MHz are allowed to be used in the North American market.



Each of these radio remote controls complies with the following requirements:  
- FCC (Federal Communication Commission) Part 15  
IC (Industry Canada) RSS-102

Unit	FCC ID	IC number
FJS	OQA-FJSNF022	9061A-FJSNF022
FJL	OQA-FJLNF022	9061A-FJLNF022
FJM	OQA-FJMNf022	9061A-FJMNf022
CRS	OQA-CRSNA022	9061A-CRSNA022

Operation is subject to the following two conditions:

- (1) this device may not cause harmful interference, and
- (2) this device must accept any interference received, including interference that may cause undesired operation.

Changes or modifications not expressly approved by the party responsible for compliance could void the user's authority to operate the equipment.

## 3.2 Applications

---

In compliance with the risk analysis (see chapter 4), this radio remote control can be installed on hoisting and material handling machines and on machines for moving, raising and transporting people (i.e. hydraulic cranes, aerial work platforms, telehandlers, concrete pumps).



**This radio remote control cannot be installed:**

- **on machines installed in places where equipment with explosion-proof characteristics is required**
- **on machines where the receiving unit power supply does not come from a battery or from a power supply unit with safety isolating transformer**
- **to control loads that are not isolated from AC power supply (if that is the case)**
- **on machines that may generate dangerous situations if they stop due to the loss of radio link**
- **on machines for which a risk analysis (see chapter 4) is not possible or gave negative results.**

Autec cannot be held responsible if the radio remote control is installed on forbidden applications.

## 3.3 Radio link

---

The two units constantly communicate with one another through a radio link. This is an essential requirement to ensure safety for the radio remote controlled machine.

Messages from the units are coded through an address stored in the S-KEY (see paragraph 13.2) and in the receiving unit. This address is unique (Autec produces it only once), univocal (specific for each radio remote control) and not reproducible. Each unit can only decode the messages coming from the unit with the same address. This prevents messages from other radio equipment from activating any system function.

The units send coded messages to one another:

- messages sent by the transmitting unit contain operational commands to be carried out by the machine
- messages sent by the receiving unit contain information useful for the automatic management of the working frequency and information about measurements collected from the machine (Data Feedback function).

## 3.4 Frequencies

---

The radio link between the units of Autec Dynamic series radio remote controls is built at one of the frequencies permitted by the European standards in force when the system is put on the market.

Dynamic series industrial radio remote controls communicate either in dynamic or static mode. Mode is set by the machine manufacturer.

### 3.4.1 Dynamic mode

A radio remote control communicating in dynamic mode:

- uses a working frequency in the band 915 - 928 MHz
- checks that the frequency is free before using it
- continually changes the working frequency to maintain the radio link even when interference occurs.

### 3.4.2 Static mode

A radio remote control communicating in static mode:

- uses a working frequency in the band 915 - 928 MHz
- checks that the frequency is free before using it
- always works at the same frequency until the stop function is activated (see paragraph 3.6.1).

## 3.5 Classification of commands

---

Commands sent by the transmitting unit are classified according to their type.

### 3.5.1 Command type: analogue, digital or direction command

Commands sent by the transmitting unit can either be analogue or digital.

Analogue commands generate proportional outputs as a function of the position of the corresponding actuator.

Digital commands switch the status of their corresponding output, according to the position of the related actuator. This status can either be on or off.

Direction commands are digital commands paired with analogue commands, and are used to specify the movement direction.

### 3.5.2 Name of commands

All commands sent by the transmitting unit are identified by abbreviations, which are also written in the technical data sheet to highlight the match between commands sent and machine functions.

The names of outputs in the receiving unit are not the names of commands. Check the technical data sheet to know which name they were given.

## 3.6 Safety functions

---

Autec radio remote controls are equipped with some functions that provide high safety levels, in order to safeguard the safety of people and property.

### 3.6.1 Stop function

The stop function brings the machine to a safe state every time it is necessary to stop it due to a potentially hazardous situation. This function is either voluntarily enabled by the user (active stop), as appropriate, or it cuts in automatically and autonomously (passive stop).

#### Active stop

Active stop is a function enabled by the STOP pushbutton (see paragraph 13.4). The transmitting unit sends to the receiving unit a command that immediately stops the machine. When the STOP pushbutton is pressed, the machine stops in shorter time than when passive stop cuts in.

#### Passive stop

Passive stop is a function that cuts in when a fault occurs during operation. When the radio link is incorrect or interrupted, the receiving unit autonomously stops the radio remote control. The cut-in time of this function (passive stop cut-in time) is set by the machine manufacturer (see technical data sheet).

### 3.6.2 Protection against unintended movements from the standstill position (UMFS)

This safety function protects the system “machine+radio remote control” from unintended movements, namely machine movements not activated intentionally by the user, but resulting from possible electrical and mechanical failure of the radio remote control.

Such safety function constantly checks the neutral (rest) position of the actuators that drive the machine's movements. Each time one of those actuators is operated, the transmitting unit sends both the movement command and the “SAFETY” command. This activates the two outputs that drive the safety device provided on the machine.

### 3.7 Dynamic series technical data

---

Frequency band in dynamic mode .....	915 - 928 MHz
Frequency band in static mode .....	915 - 928 MHz
Transmitting power .....	meets the requirements for free-license apparatus
Available radio channels .....	260
Available radio channels with static mode .....	260
Channel spacing .....	50 kHz
Hamming distance .....	≥ 15
Probability of undetected error .....	< 10 <sup>-15</sup>
Typical working range .....	100 m [approx. 330 ft]
Working range with Low Power function .....	30 m [approx. 100 ft]
Command response time .....	80 - 130 ms
Active stop cut-in time (typical) .....	< 80 ms
Active stop cut-in time (maximum) .....	130 ms
Passive stop cut-in time <sup>1</sup> .....	0.5 / 1.2 / 2 s
Performance Level of safety functions according to EN ISO 13849-1:	
STOP protection .....	PL e (4-wire wiring)
STOP protection .....	PL d (2-wire wiring)
Protection against unintended movements from the standstill position (UMFS) .....	PL d

---

1. Passive stop cut-in time is set by the machine manufacturer (see technical data sheet)

### 3.8 Identifying the radio remote control

The serial number (S/N) is the only reference to be used to uniquely identify the radio remote control, both if maintenance is needed and when providing statements to competent bodies.

The serial number (S/N) and other information regarding the radio remote control are provided in some plates both on the transmitting and on the receiving unit.



These plates must not be:

- removed from their position (removal will invalidate the guarantee)
- altered or damaged (contact Autec for replacement).

#### 3.8.1 Plates on the transmitting unit

The transmitting unit has three plates.

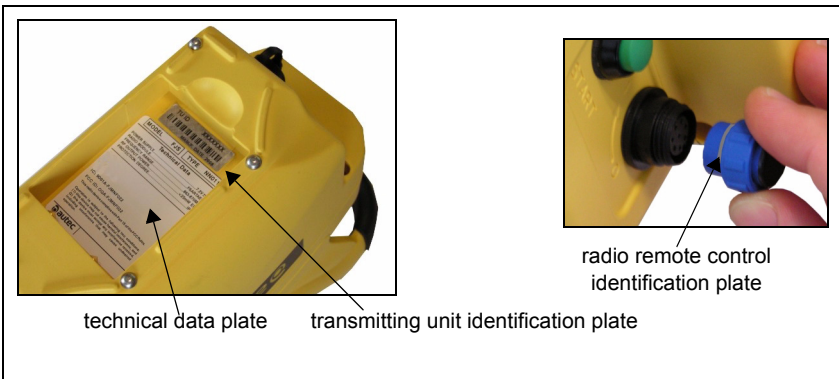

Plate	Position	Content
<b>radio remote control identification plate</b>	On the S-KEY: remove the S-KEY to read the plate.	Radio remote control serial number (S/N).
<b>transmitting unit identification plate</b>	In the battery housing: remove the battery to read the plate.	Manufacturing year, bar code and transmitting unit identification number (TU ID).
<b>technical data plate</b>	In the battery housing: remove the battery to read the plate.	MODEL, TYPE and main transmitting unit technical data, marking and possible radio remote control marks.

### 3.8.2 Plates on the receiving unit

The receiving unit has three plates.

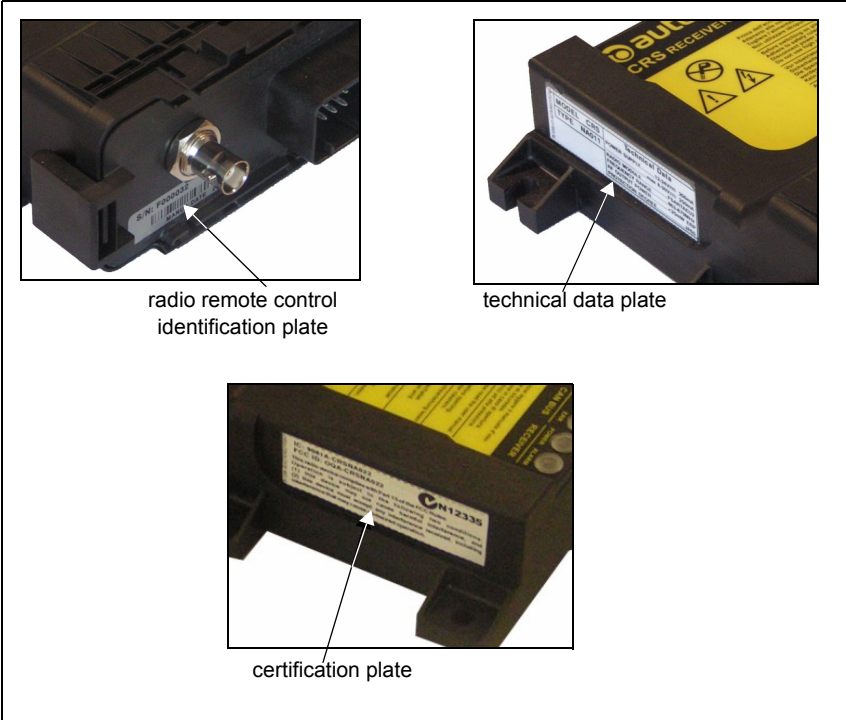

Plate	Position	Content
<b>radio remote control identification plate</b>	It is on the receiving unit casing, on the connector side	Radio remote control serial number (S/N), manufacturing year and a bar code.
<b>technical data plate</b>	On the left side of the casing	MODEL, TYPE and main receiving unit technical data, marking and possible radio remote control marks.
<b>certification plate</b>	On the right side of the casing	FCC-ID e IC number



## 4 Risk analysis

---

As required by the Machinery Directive and the related harmonised standards, all machines must undergo a risk analysis. It is therefore necessary to evaluate, within the limits of this analysis, if the machine can be radio remote controlled. The radio remote control can only be used if this analysis gives positive results.

### 4.1 Risk analysis for radio remote controlled machines

---

All warnings listed in this manual must also be taken into account during risk analysis and when setting out protection measures for the controlled machine.

When carrying out risk analysis for the machine or for the system where the radio remote control is installed, the following must be considered:

- some machines cannot be radio remote controlled by Dynamic series radio remote controls (see paragraph 3.2)
- the radio link between the two units may be interrupted due to persistent disturbance or interference.

Whenever the radio link is interrupted (i.e. due to active stop, passive stop, low battery, automatic switch off, receiving unit not powered):

- all outputs in the receiving unit are disabled (if this generates a hazardous situation, it is necessary that the corresponding commands are kept active)
- it is not possible to enable or disable the machine commands until the radio remote control is started up again.

Due to the characteristics of radio propagation (i.e.: EM interference, near out-of-range condition), a delay up to the "Passive stop time" (see paragraph 3.7) may occasionally occur from the moment a command in the transmitting unit is released to the moment its corresponding output in the receiving unit is deactivated. Those who decide upon the installation of the radio remote control must make sure that this delay never leads to a dangerous situation in the specific uses.

The transmitting unit housing is manufactured so that it protects the actuators from unintentional activation, while meeting at the same time the operating needs, the comfort requirements and law limits.

Assessment shall be made to establish possible additional protection measures for the actuators (i.e. commands requiring two-hand operation, "dead-man" function) if particular environments, equipment and working modes could cause accidental bumps to the actuators.

The machine manufacturer and/or the person who decides upon radio remote control use and installation is responsible for this risk analysis.

Autec cannot be held responsible if this analysis is not carried out correctly.

If required by the risk analysis, draw up protection measures to prevent, reduce and report potential hazard situations.

## **4.2 Working conditions**

---

To guarantee correct radio remote control operation, all current regulations regarding safety at work and accident prevention should be respected. All applicable standards and regulations valid in the user country regarding the use of both the machine and the radio remote control must always be respected.

Autec cannot be held responsible if the radio remote control is used in unlawful working conditions.

## 5 FJS transmitting unit

### 5.1 Description

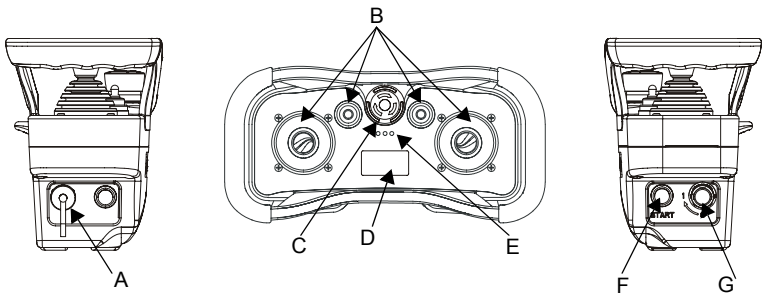

<b>A</b>	connector for wire control (if present)	<b>B</b>	actuators (joysticks, selectors, pushbuttons)
<b>C</b>	STOP pushbutton	<b>D</b>	display or LED (if present)
<b>E</b>	LEDs	<b>F</b>	START pushbutton
<b>G</b>	S-KEY (electronic starting key)		

### 5.2 Technical data

Power supply (battery MBM06MH).....	NiMH 7.2 V=
Antenna .....	internal
Housing material .....	PA 6 (20% fg)
Protection degree .....	IP65
Dimensions .....	258 x 170 x 126 mm [10.2" x 6.7" x 5"]
Weight.....	1.3 kg [2.9 lbs]
Run time (at 20°C or 68°F) .....	11 h
Run time with Data Feedback (at 20°C or 68°F) .....	9.5 h
Run time with Low Power (at 20°C or 68°F) .....	14 h
Run time with Data Feedback and Low Power (at 20°C or 68°F) .....	12.5 h

### 5.3 Light signals

The FJS transmitting units have two or three LEDs near the STOP pushbutton:

#### 5.3.1 Light signals with two LEDs

The left LED is green, the right LED is red, and they provide information regarding the radio remote control.

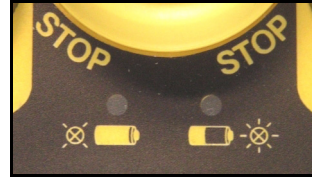

 The green LED ...	Meaning
... is off	The transmitting unit is switched off.
... blinks fast	The transmitting unit is switched on and there is no radio link.
... blinks slowly	The radio remote control is started and the radio link is present.

 The red LED <sup>a</sup> ...	Meaning
... is off	The transmitting unit works correctly.
...blinks	The battery is nearly flat.
... is on for 2 seconds <sup>b</sup>	The transmitting unit does not work correctly.
... blinks once <sup>b</sup>	At power on, the transmitting unit detects that the STOP pushbutton is activated or damaged.
... blinks twice <sup>b</sup>	At power on, the transmitting unit detects that one of the commands D2-D20 or SAFETY is activated or damaged (see technical data sheet).
... blinks three times <sup>b</sup>	At power on, the transmitting unit detects that the battery is flat.
... blinks four times <sup>b</sup>	At power on, the transmitting unit detects that one of the commands A1-A8, L1-L8 and H1-H8 is activated or damaged (see technical data sheet).



- a. An acoustic signal is also heard when the red LED is illuminated.
- b. After this signal, the transmitting unit switches off.

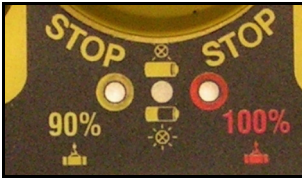

### 5.3.2 Light signals with three LEDs



Side LEDs are red and provide information coming from the machine (Data Feedback function).

The central LED is bicolour, green and red. The green LED is inhibited when the red one is on: the green LED signals only appear when the red ones pause. The central LED provides information about the radio remote control.

 <b>Central LED is green and it ...</b> 	<b>Meaning</b>
... is off	The transmitting unit is switched off.
... blinks fast	The transmitting unit is switched on and there is no radio link.
... blinks slowly	The radio remote control is started and the radio link is present.

 <b>Central LED is red and it ...<sup>a</sup></b> 	<b>Meaning</b>
... is off	The transmitting unit works correctly.
...blinks	The battery is nearly flat.
... is on for 2 seconds <sup>b</sup>	The transmitting unit does not work correctly.
... blinks once <sup>b</sup>	At power on, the transmitting unit detects that the STOP pushbutton is activated or damaged.
... blinks twice <sup>b</sup>	At power on, the transmitting unit detects that one of the commands D2-D20 or SAFETY is activated or damaged (see technical data sheet).
... blinks three times <sup>b</sup>	At power on, the transmitting unit detects that the battery is flat.
... blinks four times <sup>b</sup>	At power on, the transmitting unit detects that one of the commands A1-A8, L1-L8 and H1-H8 is activated or damaged (see technical data sheet).

- a. An acoustic signal is also heard when the red LED is illuminated.
- b. After this signal, the transmitting unit switches off.

## 6 FJL transmitting unit

### 6.1 Description

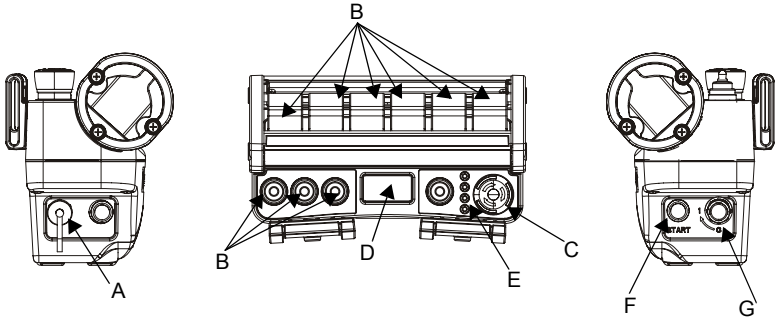





<b>A</b>	connector for wire control (if present)	<b>B</b>	actuators (joysticks, selectors, pushbuttons)
<b>C</b>	STOP pushbutton	<b>D</b>	display or LED (if present)
<b>E</b>	LEDs	<b>F</b>	START pushbutton
<b>G</b>	S-KEY (electronic starting key)		

### 6.2 Technical data

Power supply (battery MBM06MH).....	NiMH 7.2 V=
Antenna .....	internal
Housing material .....	PA 6 (20% fg)
Protection degree .....	IP65
Dimensions .....	221 x 170 x 134 mm [8.7" x 6.7" x 5.3"]
Weight.....	1.4 kg [3.1 lbs]
Run time (at 20°C) .....	11 h
Run time with Data Feedback (at 20°C) .....	9.5 h
Run time with Low Power (at 20°C) .....	14 h
Run time with Data Feedback and Low Power (at 20°C) .....	12.5 h

### 6.3 Light signals

FJL transmitting units have four LEDs on the left of the STOP pushbutton:

- a green LED, identified with  , providing information about the radio remote control.
- a red LED, identified with  , providing information about the radio remote control.
- two red LEDs (the two lower ones) that may provide information coming from the machine (Data Feedback function).



 The green LED ...	Meaning
... is off	The transmitting unit is switched off.
... blinks fast	The transmitting unit is switched on and there is no radio link.
... blinks slowly	The radio remote control is started and the radio link is present.

 The red LED <sup>a</sup> ...	Meaning
... is off	The transmitting unit works correctly.
...blinks	The battery is nearly flat.
... is on for 2 seconds <sup>b</sup>	The transmitting unit does not work correctly.
... blinks once <sup>b</sup>	At power on, the transmitting unit detects that the STOP pushbutton is activated or damaged.
... blinks twice <sup>b</sup>	At power on, the transmitting unit detects that one of the commands D2-D20 or SAFETY is activated or damaged (see technical data sheet).
... blinks three times <sup>b</sup>	At power on, the transmitting unit detects that the battery is flat.
... blinks four times <sup>b</sup>	At power on, the transmitting unit detects that one of the commands A1-A8, L1-L8 and H1-H8 is activated or damaged (see technical data sheet).

- An acoustic signal is also heard when the red LED is illuminated.
- After this signal, the transmitting unit switches off.

## 7 FJM transmitting unit

### 7.1 Description

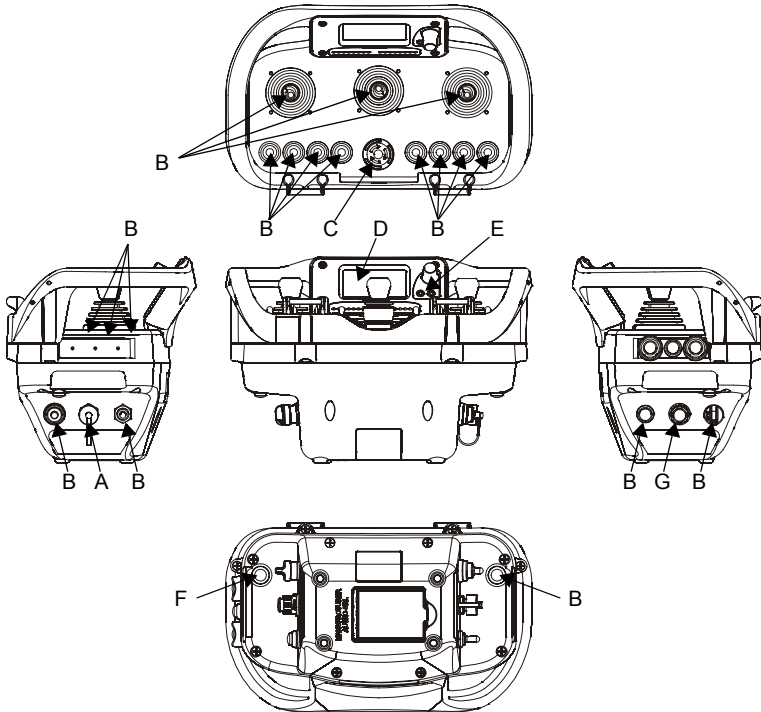

<b>A</b>	connector for wire control (if present)	<b>B</b>	actuators (joysticks, selectors, pushbuttons)
<b>C</b>	STOP pushbutton	<b>D</b>	display or LED (if present)
<b>E</b>	LEDs	<b>F</b>	START pushbutton
<b>G</b>	S-KEY (electronic starting key)		



## 7.2 Technical data

Power supply (battery MBM06MH).....	NiMH 7.2 V=
Antenna .....	internal
Housing material .....	PA 6 (20% fg)
Protection degree .....	IP65
Dimensions .....	310 x 210 x 190 mm [12.2" x 8.3" x 7.5"]
Weight.....	2.5 kg [5.5 lbs]
Run time (at 20°C) .....	11 h
Run time with Data Feedback (at 20°C) .....	9.5 h
Run time with Low Power (at 20°C) .....	14 h
Run time with Data Feedback and Low Power (at 20°C) .....	12.5 h

## 7.3 Light signals

The FJM transmitting units may have two or four LEDs.

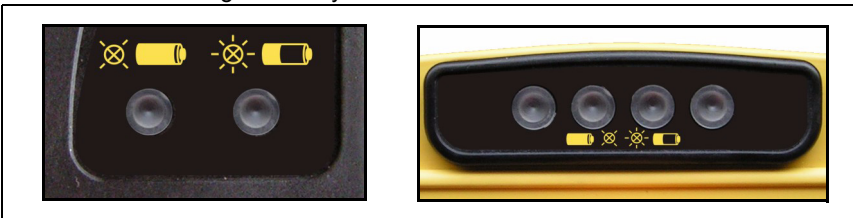

In both cases, two LEDs are always available, providing information regarding the radio remote control.

- a green LED identified with
- a red LED identified with

The green LED ...	Meaning
... is off	The transmitting unit is switched off.
... blinks fast	The transmitting unit is switched on and there is no radio link.
... blinks slowly	The radio remote control is started and the radio link is present.

 <b>The red LED<sup>a</sup> ...</b>	<b>Meaning</b>
... is off	The transmitting unit works correctly.
...blinks	The battery is nearly flat.
... is on for 2 seconds <sup>b</sup>	The transmitting unit does not work correctly.
... blinks once <sup>b</sup>	At power on, the transmitting unit detects that the STOP pushbutton is activated or damaged.
... blinks twice <sup>b</sup>	At power on, the transmitting unit detects that one of the commands D2-D20 or SAFETY is activated or damaged (see technical data sheet).
... blinks three times <sup>b</sup>	At power on, the transmitting unit detects that the battery is flat.
... blinks four times <sup>b</sup>	At power on, the transmitting unit detects that one of the commands A1-A8, L1-L8 and H1-H8 is activated or damaged (see technical data sheet).

- a. An acoustic signal is also heard when the red LED is illuminated.
- b. After this signal, the transmitting unit switches off.

If it has 4 LEDs, the side LEDs are red and provide information coming from the machine.

## 8 CRS receiving unit

### 8.1 Description

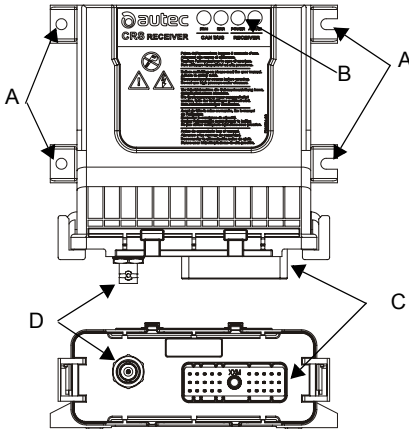

<b>A</b>	mounting holes
<b>B</b>	LEDs
<b>C</b>	plug
<b>D</b>	antenna connector

The receiving unit communicates with the machine through the STOP outputs (STOP\_1 and STOP\_2), the SAFETY outputs (SAF\_1 and SAF\_2) and the CAN network.

The receiving unit uses the CANopen® communication protocol to communicate in the CAN bus network. The receiving unit acts as a slave node within this network.

STOP and SAFETY commands are sent via CAN network and also activate their corresponding outputs.



**It is not possible to only rely on the CAN communication status to maintain or bring the remote controlled machine to a safe condition. Messages sent by the radio remote control via CAN network do not in fact ensure the same safety features as the corresponding commands that are directly carried out by the receiving unit's safety outputs.**

## 8.2 Technical data

Power supply .....	8-30 V $\overline{=}$
Absorbed power.....	3 W
Power supply protection .....	1.35 A (30 V $\overline{=}$ )
Antenna .....	dedicated
Rated current of outputs STOP_1 and STOP_2 .....	8 A (30 V $\overline{=}$ )
Rated current of output SAF_1 .....	8 A (30 V $\overline{=}$ )
Rated current of output SAF_2 .....	3 A (30 V $\overline{=}$ )
Outputs' maximum switching voltage .....	30 V $\overline{=}$
Housing material .....	PBT (30% fg) and PA6 (30% fg)
Protection degree .....	IP65
Dimensions .....	153 x 148 x 55 mm [6" x 5.8" x 2.2"]
Weight.....	0.5 kg [1.1 lbs]
Protection of outputs STOP_1_OUT and STOP_2_OUT (fail safe) .....	15 A
Protection of output SAF_1_OUT (fail safe) .....	15 A
Protection of output SAF_2_OUT (restorable) .....	4 A (25°C)

## 8.3 Light signals

The CRS receiving unit has four LEDs:

- RUN is green
- ERR is red
- POWER is green
- ALARM is red

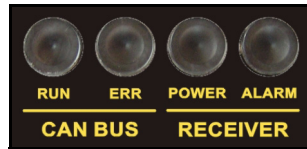

### 1. RUN LED (green)

The RUN LED indicates the status of the communication between the receiving unit and the CAN network Master node.

The RUN LED ...	Meaning
... is off	The receiving unit does not work as a CAN network node.
...blinks	The receiving unit does not send commands in the CAN network.
... is on	The receiving unit is working correctly as a node in the CAN network.

RUN LED signals reflect the guidelines of the CANopen®, standard, CiA recommendation 303-3.

## 2. ERR LED (red)

The ERR LED indicates the status of the CAN communication.

The ERR LED ...	Meaning
... is off	The CAN communication is working correctly.
...blinks	The CAN communication does not work correctly.
... is on	No CAN communication.

ERR LED signals reflect the guidelines of the CANopen®, standard, CiA recommendation 303-3.

## 3. POWER LED (green)

The POWER LED indicates the status of the receiving unit and of the radio link.

The POWER LED ...	Meaning
... is off	The receiving unit is switched off.
...blinks	Radio link has been built.
... is on	No radio link.

## 4. ALARM LED (red)

The ALARM LED warns about anomalies in the receiving unit.

The ALARM LED ...	Meaning
... is off	The receiving unit works correctly.
... blinks once	Error on the STOP outputs.
... blinks twice	Error on the SAFETY outputs.
... is on	The receiving unit does not work correctly.

## **9 Warnings for installation**

---

Besides instructions established by the machine's manufacturers, installers must always observe the following warnings.

### **9.1 General**

---

Respect and enforce the provisions of all reference standards relevant in the concerned application field (i.e. IEC 60204-32 for hoisting machines). Always follow the instructions provided in the "technical data sheet" to carry out correct installation.

### **9.2 Mounting and fastening the receiving unit in the best position**

---

Place the receiving unit so that it can be easily reached in case of need. Place the receiving unit so that it can be easily reached, and far from heat sources (i.e. exhaust pipes, heat exchangers, radiators).

Place the receiving unit vertically, with the plug facing down.

The receiving unit's back should be placed against a metal surface, to improve heat sink effect.

Fix the receiving unit in four points, using the specific holes in the housing.

Do not perforate the receiving unit in any case.

It is recommended to use the appropriate vibration dampers when installing the system on machines that produce strong vibrations.

### **9.3 Mounting and fastening the antenna in the best position**

---

Install the antenna so that shields, structures or materials do not obstruct the radio link; in particular:

the antenna must be installed in a vertical position, and possibly near the work area

the antenna must not be shielded by metal objects

The antenna must be placed at least 50 cm far from metal objects in its surroundings.

If these warnings are disregarded, the typical working range of the radio remote control may be reduced.

### **9.4 Wiring**

---

Make sure that the receiving unit's power supply is protected against short circuits and is supplied either by a battery or by a power supply unit with safety isolating transformer. Limits provided in the technical data must be observed.

The power supply of the receiving unit must have a switch that allows power supply disconnection during installation, wiring and/or maintenance operations. Connect the receiving unit immediately downstream of the machine main switch or of the electrical panel main switch.

Pay special attention to the currents flowing in outputs SAF\_1\_OUT, SAF\_2\_OUT, STOP\_1\_OUT and STOP\_2\_OUT: they shall not exceed the maximum permitted values (see paragraph 8.2).

The current of STOP outputs is interrupted at regular intervals for approx. 1 ms every 100 ms. If STOP outputs are used to power electronic devices, check that they are compatible with this recurring interruption (use suitable filters if necessary).

## **9.5 At end of installation**

---

Make sure that during installation the safety mechanisms on the radio remote control and/or in the machine have not been made ineffective by possible procedures carried out.

## **9.6 Testing**

---

After installation and wiring, test the system "machine+radio remote control", and check that the operations carried out correspond exactly to the commands sent (in particular check the STOP command).

The installer must check and complete the "Technical Data Sheet" in all its parts, adding the date the system has been put into service, his stamp and signature.

In case of malfunction, disable the system "machine+radio remote control" until the problem has been completely solved.

## 10 Warnings for use

---

In addition to all instructions provided by the machine manufacturer, by the installer of the radio remote control and by the person responsible for the safety of the work area, users shall always respect the following warnings.



### 10.1 Before starting to work

---

**The transmitting unit shall be used in a simple and comfortable way, avoiding accidental falls. The harness provided with the radio remote control serves as such.**

**Stand in a position that allows the direct supervision of the remote controlled machine and its load, and stay in a place ensuring safety conditions in respect of other operations and/or activities and/or processes that are carried out in the working environment.**

**Never start up or use the transmitting unit if the working conditions present the risk of losing balance or tripping.**

**Always check that the mechanical operation of the STOP pushbutton is correct. If it is impossible or difficult to press this pushbutton, do not use the radio remote control.**

**Only start up the transmitting unit when starting work: improper use may cause hazardous situations.**

**Never start up or use the transmitting unit in closed spaces, with the machine not in sight, or outside the radio remote control typical working range: in such cases it is in fact still possible to build a radio link, thus causing the risk that unwanted commands be carried out by the machine.**



### 10.2 During normal operation

---

**Visually and directly follow all movements of the machine and its load and remain inside the radio remote control working range.**

**Pay particular attention to warnings and visual and acoustic signals, and take all measurements and steps to avoid that movements of the remote controlled machine may lead to hazardous situations for people and/or property.**

**Pay attention to the entire work area. Immediately press the STOP pushbutton when a hazardous situation occurs.**



In case of malfunction, disable the system “machine+radio remote control” until the problem has been completely solved.



### **10.3 After using the radio remote control**

---

**Switch off the transmitting unit when work is stopped or temporarily interrupted. Do not leave the load hanging (even when changing the battery).**

**Never leave the transmitting unit unguarded when the S-KEY is inserted.**

**Always store the S-KEY in a safe place each time it is removed from the transmitting unit. If this key is lost, the radio remote control cannot work, since the transmitting unit needs the address stored in the key to work with its receiving unit.**

## 11 Radio remote control lifecycle

---

To ensure a safe and long-lasting operation of Dynamic series industrial radio remote controls, carefully follow the instructions provided for each stage of the product lifecycle.

### 11.1 Transportation and storage

---



Radio remote controls must always be transported and stored inside their original packing until they are installed on the machine.

Environmental transportation and storage conditions are given in the following table.

	Temperature	Relative Humidity	Air Pressure
<b>Transportation</b>	Class 2K3 -40°C to +70°C [-40°F to +158°F]	Class 2K3 95%	Class 2K3 70 kPa to 106 kPa
<b>Storage</b>	Class 1K5 -40°C to +80°C [-40°F to +176°F]	Class 1K3 5% to 95%	Class 1K5 70 kPa to 106 kPa

### 11.2 Installation

---



The radio remote control can only be installed and tested by competent staff that masters the technical knowledge required to carry out such procedure and is qualified according to the regulation of the country where the radio remote control is mounted.

Only if the radio remote control is installed correctly can it be used safely.



WARNING

**Always follow the instructions provided in the technical data sheet to carry out correct installation.**



WARNING

**Please contact the machine manufacturer or the person who decided upon the installation of the radio remote control for instructions and warnings regarding the installation.**

All warnings for a correct installation are given in chapter 9.

### 11.3 Use

The use of industrial radio remote controls is strictly limited to skilled and properly trained personnel.



**When the radio remote control is installed on mobile machines, switch off the receiving unit when the vehicle travels.**

All warnings for a correct use are given in chapter 10.

All instructions for a correct use are given in chapters 12 and 13.

Environmental working conditions are given in the following table.

	Temperature	Relative Humidity	Air Pressure
<b>Transmitting unit</b>	Class 5K4H -25°C to +55°C [-13°F to +131°F]	Class 5K2 5% to 95%	Class 5K2 70 kPa to 106 kPa
<b>Receiving unit</b>	Class 5K2 -25°C to +70°C [-13°F to +158°F]		

### 11.4 Maintenance



The following instructions provide information to safely carry out routine and special maintenance operations for the radio remote control.

They shall be completed by:

- instructions provided by the machine manufacturer
- directions provided by the installer of the radio remote control on the machine
- regulations regarding safety at work and accident prevention in force in the country where the radio remote control is used.

All fine-tuning, checking and maintenance actions carried out on the radio remote control shall be verified and recorded by the person in charge of carrying out maintenance on the machine.



**In case of failure, emergencies or damaged parts, disable the system “radio remote control+machine” until the problem has been completely solved.**



Never open the CRS receiving unit.



**Before any maintenance operation:**

- **remove the battery from the transmitting unit**
- **disconnect power from the receiving unit.**



**After any maintenance operation:**

- **always make sure that commands sent by the transmitting unit only activate the corresponding expected operations**
- **if the transmitting unit has been opened, close it correctly, in order not to endanger its protection degree from dust and water: check that the gasket is intact, correctly overlay the two parts of the housing and tighten the screws.**

**11.4.1 Routine maintenance**



Routine maintenance consists of operations needed to preserve the radio remote control normal usage conditions, thus implementing fine-tuning, checks, planned replacement actions that necessarily arise from the normal use of the product.

All given instructions must be followed correctly at each commissioning, that is:

- whenever the radio remote control and/or the machine is installed or assembled
- whenever the machine location/position changes
- after special maintenance.

Routine maintenance carried out as described in this manual is fundamental for using the radio remote control safely.

Special applications may need more specific routine maintenance actions to be carried out at different periods (i.e. if the working environment is particularly dirt, in case of heavy applications or if the system is used very frequently, some maintenance actions may be required more frequently, depending on the decision of the person in charge for safety in the worksite).

**11.4.2 Daily routine maintenance**

Before starting to work:

- make sure that the battery housing and the battery contacts are always clean
- make sure that the gaskets, bellows and caps of the actuators (joysticks, selectors and pushbuttons) are intact, soft and elastic
- make sure that the transmitting unit panel symbols can be easily recognised and replace the panel if necessary
- check that the three plates on the transmitting unit are readable and intact
- make sure that the mechanical operation of the STOP pushbutton is correct.

During normal operation:

- check structural integrity of the transmitting unit
- make sure that materials that could endanger the transmitting unit usage and safety (such as concrete, sand, lime, dust) do not deposit on it.

After using the radio remote control:

- clean the transmitting unit: never use solvents or flammable/corrosive materials and do not use high-pressure water cleaners or steam cleaners
- store the transmitting unit in clean and dry areas.

#### 11.4.3 Three-month routine maintenance

Every three months:

- remove dust or deposit of material from the receiving unit: never use solvents or flammable/corrosive materials to clean it, and do not use high-pressure water cleaners or steam cleaners
- check structural integrity of the receiving unit
- make sure that the wiring of the receiving unit is intact and connected
- make sure that the receiving unit panel symbols can be easily recognised and replace the panel if necessary
- check that the plates on the receiving unit are readable and intact.

#### 11.4.4 Special maintenance



Special maintenance consists of repairs needed due to radio remote control failure, damage or malfunction, carried out with the aim of restoring the original usage and working conditions.

Prior to contacting the support service technicians of the machine's manufacturer:

- read and understand all parts of this manual, and make sure that all the instructions it contains have been accomplished correctly
- follow the instructions to detect possible malfunctions and their origins (see chapter 14).



**Any fault should be repaired by authorised personnel only (contact the support service of the machine's manufacturer), using original Autec spare parts only.**

The following radio remote control data must be reported in order to make interventions faster and more reliable:

- radio remote control serial number (S/N) and TU ID (transmitting unit identification number)
- purchase date (given on the certificate of guarantee)
- description of the problem found
- address and telephone number of the place where the device is being used (with the name of the person to contact)
- local supplier.

## 11.5 Machine maintenance

---

Follow instructions provided by the machine manufacturer and by the installer of the radio remote control, in order to carry out machine maintenance.



DANGER

**When carrying out maintenance operations on the machine:**

- **always remove the S-KEY from the transmitting unit**
- **disconnect power from the receiving unit**



CAUTION

**Disconnect the plug and the antenna from the CRS receiving unit whenever machine maintenance is carried out (i.e. when soldering).**

## 11.6 Disposal

---

When disposing of a radio remote control, give it to the waste separate collecting services in the user's country.

Please pay particular attention when recycling the batteries: apply local rules. Do not throw them away with domestic trash.

## 12 General operating instructions

---

### 12.1 Starting up the radio remote control

---

Starting up the radio remote control consists in building a radio link between the transmitting and the receiving unit. For this purpose, you need to:

1. power on the receiving unit respecting the voltage limits provided in the technical data (see paragraph 8.2). The POWER LED switches on
2. power on the transmitting unit:
  - insert a charged battery in the transmitting unit (see paragraph 13.1)
  - insert the S-KEY in the transmitting unit. The green LED starts blinking fast
3. press the START pushbutton in the transmitting unit until the POWER LED in the receiving unit and the green LED in the transmitting unit start blinking slowly.

### 12.2 Command activation

---

With the radio remote control started, act on the joysticks, pushbuttons and switches corresponding to the command to be performed.

The user must be properly trained about the symbols on the transmitting unit panel, to be aware of the matching between actuators and movements on the machine (symbols used are defined by the machine manufacturer according to the functions of the machine).

Some specific commands may be present on the transmitting unit: see paragraph 13.5.

### 12.3 Data Feedback Function

---

The user receives information and/or signals concerning the controlled machine by means of the Data Feedback function.

During normal radio remote control operation, pay particular attention to the indications displayed and signalled by the display or through the LEDs: they can be helpful to evaluate the machine working status.



WARNING

**Any information shown and signalled on the display or through the LEDs can never be considered or used as a safety signal or for legal metrology.**



WARNING

**When operating and moving the machine, remember that the radio remote control does not intervene autonomously when potential hazard situations are displayed and signalled.**

### **12.3.1 Operation with display**

If the transmitting unit has a display, it is possible to show signal icons, measurements collected from the machine and their description.

Information displayed and how it is displayed (icons and/or measurements and/or descriptions) depend on the settings chosen by the machine manufacturer.

In addition, two indicators are always present:

- battery charge level (at the bottom on the left)
- quality of radio link (at the bottom on the right).

### **12.3.2 Operation with LED**

If the transmitting unit has an LED array, particular machine conditions are signalled when they are on (i.e. load limits, limit switch, ...).

The signalled conditions depend on the settings chosen by the machine manufacturer.

## **12.4 Automatic interruption of the radio link**

---

When the radio link is incorrect or interrupted for a certain period of time, the passive stop function automatically cuts in (see paragraph 3.6.1).

The green LED on the transmitting unit switches from blinking slowly to fast blinking.

The POWER LED on the receiving unit switches from blinking to steady on.

Press the START pushbutton to start the radio remote control.

## **12.5 Transmitting unit automatic switch off**

---

The transmitting unit automatically switches off when:

- the battery is flat (see paragraph 12.5.1)
- the radio remote control is not used for a certain time (see paragraph 12.5.2)
- the transmitting unit is powered and never switched off for eight hours non-stop (see paragraph 12.5.3).

The green LED on the transmitting unit switches off.

The POWER LED on the receiving unit switches from blinking to steady on.

Press the START pushbutton to start the radio remote control.

### **12.5.1 Low battery**

The transmitting unit indicates if the battery is not sufficiently charged (the red LED blinks and an acoustic signal sounds).

The transmitting unit automatically switches off after 3.5 minutes from the beginning of the signal.

The battery shall be replaced with a charged one (see paragraph 13.1).



### 12.5.2 When the transmitting unit is not used

The transmitting unit automatically switches off after the “automatic switch off time” has elapsed; during that time, the unit stays on without movement commands activated.

The activation of this function and its cut-in time are set by the machine manufacturer (see technical data sheet).

### 12.5.3 Non-stop use

The transmitting unit indicates if it has been used for eight hours non-stop (the red LED blinks and an acoustic signal sounds).

The transmitting unit automatically switches off after 3.5 minutes from the beginning of the signal.

## 12.6 Switching off the transmitting unit

---

The transmitting unit shall be switched off each time work is stopped: remove the S-KEY (see paragraph 13.2) and always store it in a safe place.

## 12.7 Switching off the receiving unit

---

The receiving unit shall be switched off each time the radio remote control is not used to control the machine. Remove power from the unit to switch it off.



**When the radio remote control is installed on mobile machines, switch off the receiving unit when the vehicle travels.**

## 13 Working

---

### 13.1 BATTERY

---



FJS, FJL and FJM transmitting units can only be powered through Autec rechargeable batteries.

See the battery charger manual enclosed in the packaging with the battery charger for any warnings and instructions regarding the batteries.

Batteries shall be inserted in their housing in the transmitting unit, with the technical data plate facing down and their contacts towards the contacts on the transmitting unit.

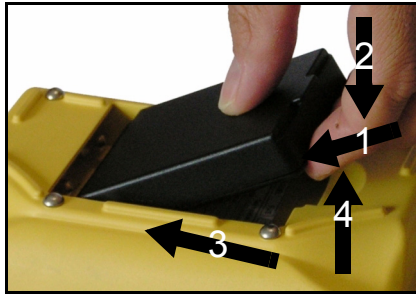

To insert a battery, proceed as follows:

1. push the battery towards the contacts on the transmitting unit
2. push the battery downwards.

To remove a battery, proceed as follows:

3. push the battery towards the contacts on the transmitting unit
4. lift the battery.

### 13.2 S-KEY

---

In the transmitting unit, the radio remote control address is stored in the S-KEY. For this reason, the radio remote control cannot work without this key.



**The S-KEY can only be used in the transmitting unit of the radio remote control where it belongs (main transmitting unit).**





As the radio remote control address is stored in the S-KEY, use it with utmost care to reduce risks that may result from incorrect handling.



If the main transmitting unit cannot be used because it has been lost or damaged, the back-up transmitting unit can be used instead. In this case, insert the S-KEY in the back-up unit. The back-up unit is identical to the main unit; the only difference is the presence of the plate “BACK-UP UNIT” on the battery housing.

### 13.3 START pushbutton

---

The START pushbutton is used to:

- start up the radio remote control (see paragraphs 12.1, 12.4 and 12.5)
- activate the horn when the radio remote control is started.



### 13.4 STOP

---



**The STOP pushbutton should be pressed when it is necessary to stop the machine immediately when a dangerous condition should occur.**

When the STOP pushbutton is pressed, the machine stops (active stop: see paragraph 3.6.1), and the transmitting unit switches off.

To start working again after the STOP pushbutton has been pressed:

1. make sure that the working and usage conditions are safe
2. turn the STOP pushbutton in the arrow direction to unlock it
3. start up the radio remote control (see paragraph 12.1).

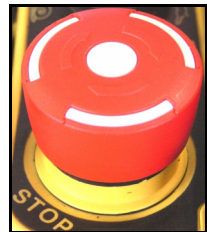

### 13.5 Command meaning

Commands on the transmitting unit are established according to the machine's operations and functions. They are established by the machine manufacturer, who also chooses the symbols used.

Some of the commands available on the transmitting unit may be those provided below; in this case, symbols used are generally those given here:

#### RPM +/-

This switch increases (rpm +) or decreases (rpm -) the engine revolutions of the remote controlled machine.





#### MOVEMENT SPEED SELECTOR

This switch is used to modify the movement speed. According to the configuration:

- it sets two or three speed levels
- it increases and/or decreases speed.



These three symbols are used:

Symbol	Meaning
	This symbol indicates the typical machine's speed.
	This symbol indicates a reduction in the machine's speed (the reduction is set by the manufacturer).
	This symbol, if present, indicates a further reduction in the machine's speed (the reduction is set by the manufacturer).



#### ENGINE

This switch is used to switch on and off the engine of the remote controlled machine.

Symbol	Meaning
	This symbol indicates that the engine is powered on.
	This symbol indicates that the engine is switched off.



### DISPLAY pushbutton (if the transmitting unit has a display)

This pushbutton is used to:

- activate the display lighting, if it is off
- cyclically scroll the information on the display in two different modes:
  - manual: the lines scroll up each time the pushbutton is pressed
  - automatic: when the DISPLAY pushbutton is pressed for 3 seconds, the lines scroll automatically. If the DISPLAY pushbutton is pressed another time, it switches back to manual mode.



It is not possible to scroll the lines if only icons are displayed. The display lighting stays on for a time set by the machine manufacturer.

## 13.6 Low Power function

---

The LOW POWER function allows transmission at a lower power than the nominal power (see paragraph 3.7) and reduces the radio remote control working range.

This function aims at:

- making it easier to work with several systems in the same working environment (i.e.: many working machines in the same working area)
- extending the battery run-time.

This function is established by the machine manufacturer (see technical data sheet).

## 13.7 Wire control

---

The wire control is used:

- in particular working conditions, established by the machine manufacturer
- when it is not possible to build a radio link between the radio remote control units
- when working in environments where using radio frequencies is not allowed or is dangerous
- when a fully charged battery is not available.



**When using the wire control, it is not possible to eliminate the electric shock hazard when working near in-ground or overhead high voltage electrical cables.**

### 13.7.1 Description

The wire control connects the transmitting unit to the receiving unit through a cable that replaces the radio link. The cable shall be plugged in the suitable connectors, one on the transmitting unit and the other placed where established by the machine manufacturer.



When using the wire control, the working features do not change (i.e. the meaning of actuators and the Data Feedback function).

### 13.7.2 Working



CAUTION

Before starting to work, make sure that the cable and the corresponding connectors are intact.

The wire control can only be connected and disconnected when the transmitting unit is switched off.

After connecting or disconnecting the wire control, start up the radio remote control (see paragraph 12.1) to control the machine.

During operation with wire control:

- radio link is off
- leave the battery inside the transmitting unit, even though the power supply comes from the receiving unit.

The battery is not, in any case, recharged through the wire control: it can only be recharged through its appropriate battery charger provided together with the system.



When you finish working with the wire control, disconnect the cable from the transmitting unit and from the machine, and protect the four connectors with their caps.

## 14 Troubleshooting

---

When the radio remote control does not work:

- bring the transmitting unit close to the receiving unit to avoid radio interference and disturbances
- establish whether the problem lies with the radio remote control or with the machine.

Therefore, before any inspection, try to control the machine from a control unit different from the radio remote control, if present.

If the problem persists, it lies with the machine.

If not, the problem may lie with the radio remote control. In such case, please refer to paragraph 14.3.

### 14.1 Radio remote controls with Data Feedback function

---

It is still possible that the transmitting unit sends commands to control the machine even though the Data Feedback function does not work properly, or if there is no information and/or signals coming from it.

To check that the radio remote control works properly, please refer to paragraph 14.3.



CAUTION

When the display or the LED array does not work, please contact the support service of the machine manufacturer, even if no one of the problems indicated in paragraph 14.3 has been detected.

### 14.2 Radio remote controls with wire control

---

Please refer to paragraph 14.3 to check that the radio remote control works properly.

Possibly use the wire control to check if radio interference occurs.

On the contrary, if you want to check that the wire control works properly:

- connect the cable to the transmitting unit and to the machine
- check that the manoeuvres carried out by the machine correspond to the commands sent by the transmitting unit.

### 14.3 Solutions in case of malfunction

Identify the radio remote control malfunction according to the light signals on the units. If the problem persists after the suggested solution has been carried out, contact the support service of the machine manufacturer.

#### 14.3.1 Malfunction signalled by the transmitting unit

Signals	Possible reason	Solutions
The green LED does not switch on when the START pushbutton is pressed, even though both the battery and the S-KEY are inserted.	The battery is flat.	Replace the battery with a charged one.
The green LED blinks fast.	No radio link.	Bring the transmitting unit close to the receiving unit.
The red LED switches on for 2 seconds and then the unit switches off.	The transmitting unit does not work correctly.	Contact the support service of the machine manufacturer.
The red LED blinks once during start up.	The STOP pushbutton is locked or damaged.	Unlock the STOP pushbutton. If this signal persists, contact the support service of the machine manufacturer.
The red LED blinks twice during start up.	At least one of the actuators corresponding to commands D2-D20 is activated or damaged.	Bring the actuators to the rest position. If this signal persists, contact the support service of the machine manufacturer.
The red LED blinks three times during start up.	The battery is flat.	Replace the battery with a charged one.
The red LED blinks four times during start up.	At least one of the actuators corresponding to commands A1-A8 and H1-H8 is activated or damaged.	Bring the actuators to the rest position. If this signal persists, contact the support service of the machine manufacturer.



### 14.3.2 Malfunction signalled by the receiving unit

Signals	Possible reason	Solutions
The POWER LED is off.	The receiving unit is switched off.	Correctly plug in the connecting plug and power on the receiving unit.
The POWER LED is on.	No radio link.	Bring the transmitting unit close to the receiving unit.
The ALARM LED blinks once.	Error on the STOP outputs.	Correctly plug in the connecting plug. Make sure that the STOP outputs are wired correctly.
The ALARM LED blinks twice.	Error on the SAFETY outputs.	Correctly plug in the connecting plug. Make sure that the SAFETY outputs are wired correctly.
The ALARM LED is on.	The receiving unit does not work correctly.	Contact the support service of the machine manufacturer.
The RUN LED blinks.	The receiving unit does not send commands in the CAN network.	Contact the support service of the machine manufacturer.
The ERR LED blinks.	CAN communication error.	Contact the support service of the machine manufacturer.





