

Dynamic series
user manual

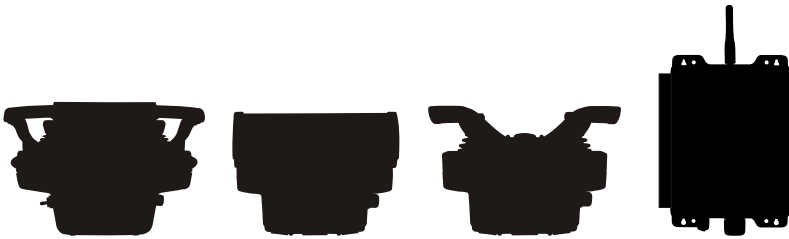

Dynamic series
user manual

INDEX

1	User manual	53
1.1	General instructions	53
1.2	Symbol conventions	54
2	Documentation	55
2.1	Battery charger manual	55
2.2	Technical data sheet	55
2.3	Guarantee	55
3	Dynamic series description	56
3.1	Conformity	56
3.2	Applications	57
3.3	Radio link	57
3.4	Frequencies	58
3.5	Classification of commands	58
3.6	Safety functions	59
3.7	Dynamic series technical data	60
3.8	Identifying the radio remote control	61
4	Risk analysis	63
4.1	Risk analysis for radio remote controlled machines	63
4.2	Working conditions	64
5	FJS transmitting unit	65
5.1	Description	65
5.2	Technical data	65
5.3	Light signals	66
6	FJL transmitting unit	68
6.1	Description	68
6.2	Technical data	68
6.3	Light signals	69
7	FJM transmitting unit	70
7.1	Description	70
7.2	Technical data	71
7.3	Light signals	71
8	ARM receiving unit	73
8.1	Description	73
8.2	Mother board	74
8.3	Technical data	74
8.4	Light signals	75
9	Warnings	78
9.1	Before starting to work	78
9.2	During normal operation	78
9.3	After using the radio remote control	79
10	Radio remote control lifecycle	80
10.1	Transportation and storage	80

10.2 Installation	80
10.3 Use	81
10.4 Radio remote control maintenance	81
10.5 Machine maintenance	84
10.6 Disposal	84
11 General operating instructions	85
11.1 Starting up the radio remote control	85
11.2 Command activation	85
11.3 Data Feedback Function	85
11.4 Radio link interruption	86
11.5 Transmitting unit automatic switch off	86
11.6 Switching off the transmitting unit	87
11.7 Switching off the receiving unit	87
12 Working	88
12.1 BATTERY	88
12.2 S-KEY	88
12.3 START pushbutton	89
12.4 STOP	89
12.5 Command meaning	90
12.6 Low Power function	91
12.7 Wire control	92
13 Values of proportional outputs	94
13.1 REMOTE SETUP procedure	94
13.2 Restoring factory settings	95
14 Data memory backup	96
15 Troubleshooting	97
15.1 Radio remote controls with Data Feedback function	97
15.2 Radio remote controls with wire control	97
15.3 Solutions in case of malfunction	98

The documentation enclosed with the user manual of Dynamic series radio remote controls always consists at least of:

- battery charger manual
- technical data sheet
- guarantee booklet and its related validation slip.

When purchasing a radio remote control, make sure that all the following documents are supplied: if they are not, please ask for a copy from Autec, reporting the radio remote control serial number (S/N).

The documentation must be kept for the whole life of the radio remote control: after reading it, keep it on hand for future reference.

AUTEC - Dynamic Series

User manual

1 User manual

This manual is intended for Autec Dynamic series radio remote controls.

It contains warnings, information and instructions for:

- FJS, FJL and FJM transmitting units
- ARM receiving units.



FJS transmitting unit

FJL transmitting unit

FJM transmitting unit

ARM receiving unit

1.1 General instructions

This manual is an integral part of the radio remote control and it aims at providing the instructions needed for using and maintaining the system, with an eye on its safety functions.

Always remember that:

- photos and drawings in this manual are useful examples that help understand the instructions and warnings of each radio remote control configuration
- if necessary, contact Autec if any of the instructions and/or warnings given in this manual are not clear.

No part of this manual may be reproduced, in any form or by any means, without written permission of Autec (including recording and photocopying).
If this manual is lost or damaged, ask Autec for a copy. Please specify the serial number of the related radio remote control.

Information contained in this manual adds to and completes the information provided by the manufacturer of the remote controlled and/or by those who install the radio remote control on the machine.

All installation, usage and maintenance operations must be carried out by qualified technicians who are suitably trained with respect to the relevant norms and laws.



Therefore, this manual must be read and understood in all its parts by the user and by:

- the radio remote control owner and/or installer
- the person responsible for and in charge of maintenance and/or safety in the workplace where the radio remote control is used.

As for instructions and warnings regarding the machine where the radio remote control is installed, follow the instructions given in the machine's manual.

1.2 Symbol conventions

Three symbols are employed in this manual, which are used to highlight specific safety-related issues. They are classified according to the hazardous situation that may arise and on the possible consequences:

Symbol	If the highlighted instructions are not respected, this leads to hazardous situations with the following characteristics:		
	dangerous situation	gravity of consequences for people	gravity of consequences for property
 DANGER	...highly probable.	... critical (death or physical damage).	... critical.
 WARNING	... probable.	... critical (death or physical damage).	... critical.
 CAUTION	... probable.	... moderate (non-severe physical damage).	... moderate.



This symbol is also used, and it identifies texts to be read carefully.

2 Documentation

2.1 Battery charger manual

The battery charger manual contains instructions and warnings for a correct use of the battery charger and of batteries.

It is included in the battery charger package.

2.2 Technical data sheet

The technical data sheet contains the transmitting unit configuration and shows the matching between commands sent and machine functions/movements.

It also contains the wiring diagram showing the connection between the receiving unit and the machine.

Two copies of the technical data sheet are provided together with the ARM receiving unit: one is inside the receiving unit and the other one is enclosed with this manual. Both technical data sheets must be filled in, checked and signed by the installer, who is responsible for a correct wiring.

Please keep one technical data sheet inside the receiving unit and the other together with this manual (always keep a copy of this data sheet for administrative purposes).



The wiring of the receiving unit outputs must always reflect the wiring indicated in the technical data sheet.

2.3 Guarantee

Guarantee terms and conditions for the radio remote control are stated in the related booklet.

3 Dynamic series description

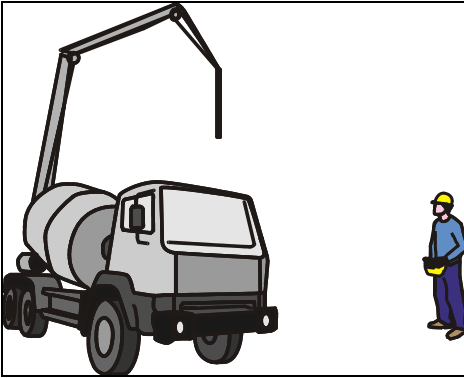

Autec Dynamic series industrial radio remote controls are used to control machines from a distance, without physical connections (i.e. wires or connecting cables) between the user and the machine. Each of these industrial radio remote controls consists of a portable transmitting unit, from which the user can remotely control the machine, and a receiving unit installed on board the machine itself.

3.1 Conformity

Dynamic series radio remote controls working within the frequency band 915 - 928 MHz are allowed to be used in the North American market.



Each of these radio remote controls complies with the following requirements:
- FCC (Federal Communication Commission) Part 15
IC (Industry Canada) RSS-102

Unit	FCC ID	IC number
FJS	OQA-FJSNF022	9061A-FJSNF022
FJL	OQA-FJLNF022	9061A-FJLNF022
FJM	OQA-FJMNF022	9061A-FJMNF022
ARM	OQA-ARMNB022	9061A-ARMNB022

Operation is subject to the following two conditions:

- (1) this device may not cause harmful interference, and
- (2) this device must accept any interference received, including interference that may cause undesired operation.

Changes or modifications not expressly approved by the party responsible for compliance could void the user's authority to operate the equipment.

3.2 Applications

In compliance with the risk analysis (see chapter 4), this radio remote control can be installed on hoisting and material handling machines and on machines for moving, raising and transporting people (i.e. hydraulic cranes, aerial work platforms, telehandlers, concrete pumps).



This radio remote control cannot be installed:

- **on machines installed in places where equipment with explosion-proof characteristics is required**
- **on machines where the receiving unit power supply does not come from a battery or from a power supply unit with safety isolating transformer**
- **to control loads that are not isolated from AC power supply (if that is the case)**
- **on machines that may generate dangerous situations if they stop due to the loss of radio link**
- **on machines for which a risk analysis (see chapter 4) is not possible or gave negative results.**

Autec cannot be held responsible if the radio remote control is installed on forbidden applications.

3.3 Radio link

The two units constantly communicate with one another through a radio link. This is an essential requirement to ensure safety for the radio remote controlled machine.

An address is stored in the S-KEY (see paragraph 12.2) and in the address key on the IDK connector in the receiving unit (see paragraph 8.1); the units use this address to code their messages. This address is unique (Autec produces it only once), univocal (specific for each radio remote control) and not reproducible. Each unit can only decode the messages coming from the unit with the same address. This prevents messages from other radio equipment from activating any system function.

The units send coded messages to one another:

- messages sent by the transmitting unit contain operational commands to be carried out by the machine
- messages sent by the receiving unit contain information useful for the automatic management of the working frequency and information about measurements collected from the machine (Data Feedback function).

3.4 Frequencies

The radio link between the units of Autec Dynamic series radio remote controls is built at one of the frequencies permitted by the European standards in force when the system is put on the market.

Dynamic series industrial radio remote controls communicate either in dynamic or static mode. Mode is set by the machine manufacturer.

3.4.1 Dynamic mode

A radio remote control communicating in dynamic mode:

- uses a working frequency in the band 863 - 870 MHz
- checks that the frequency is free before using it
- continually changes the working frequency to maintain the radio link even when interference occurs.

3.4.2 Static mode

A radio remote control communicating in static mode:

- uses a working frequency in the band 869.7 - 870 MHz
- checks that the frequency is free before using it
- always works at the same frequency until the stop function is activated (see paragraph 3.6.1).

3.5 Classification of commands

Commands sent by the transmitting unit are classified according to their type.

3.5.1 Command type: analogue, digital or direction command

Commands sent by the transmitting unit can either be analogue or digital.

Analogue commands generate proportional outputs as a function of the position of the corresponding actuator.

Digital commands switch the status of their corresponding output, according to the position of the related actuator. This status can either be on or off.

Direction commands are digital commands paired with analogue commands, and are used to specify the movement direction.

3.5.2 Name of commands

All commands sent by the transmitting unit are identified by abbreviations, which are also written in the technical data sheet to highlight the match between commands sent and machine functions.

The names of outputs in the receiving unit are not the names of commands. Check the technical data sheet to know which name they were given.

3.6 Safety functions

Autec radio remote controls are equipped with some functions that provide high safety levels, in order to safeguard the safety of people and property.

3.6.1 Stop function

The stop function brings the machine to a safe state every time it is necessary to stop it due to a potentially hazardous situation. This function is either voluntarily enabled by the user (active stop), as appropriate, or it cuts in automatically and autonomously (passive stop).

Active stop

Active stop is a function enabled by the STOP pushbutton (see paragraph 12.4). The transmitting unit sends to the receiving unit a command that immediately stops the machine. When the STOP pushbutton is pressed, the machine stops in shorter time than when passive stop cuts in.

Passive stop

Passive stop is a function that cuts in when a fault occurs during operation. When the radio link is incorrect or interrupted, the receiving unit autonomously stops the radio remote control. The cut-in time of this function (passive stop cut-in time) is set by the machine manufacturer (see technical data sheet).

3.6.2 Protection against unintended movements from the standstill position (UMFS)

This safety function protects the system “machine+radio remote control” from unintended movements, namely machine movements not activated intentionally by the user, but resulting from possible electrical and mechanical failure of the radio remote control.

Such safety function checks the neutral (rest) position of the actuators that control the machine's movements. Each time one of those actuators is operated, the transmitting unit sends both the movement command and the “SAFETY” command. Depending on the specific application, outputs related to these commands are wired in series; alternatively the SAFETY command's outputs drive the safety device provided on the machine.

3.7 Dynamic series technical data

Frequency band in dynamic mode	915 - 928 MHz
Frequency band in static mode	915 - 928 MHz
Transmitting power	meets the requirements for free-license apparatus
Available radio channels	260
Available radio channels with static mode	260
Channel spacing	50 kHz
Hamming distance	≥ 15
Probability of undetected error.....	$< 10^{-15}$
Typical working range.....	100 m [approx. 330 ft]
Working range with Low Power function.....	30 m [approx. 100 ft]
Command response time	80 - 130 ms
Active stop cut-in time (typical).....	< 80 ms
Active stop cut-in time (maximum).....	130 ms
Passive stop cut-in time ¹	0.5 / 1.2 / 2 s
Performance Level of safety functions according to EN ISO 13849-1:	
STOP protection	PL e (4-wire wiring)
STOP protection	PL d (2-wire wiring)
Protection against unintended movements from the standstill position (UMFS)	PL d

1. Passive stop cut-in time is set by the machine manufacturer (see technical data sheet)

3.8 Identifying the radio remote control

The serial number (S/N) is the only reference to be used to uniquely identify the radio remote control, both if maintenance is needed and when providing statements to competent bodies.

The serial number (S/N) and other information regarding the radio remote control are provided in some plates both on the transmitting and on the receiving unit.



These plates must not be:

- removed from their position (removal will invalidate the guarantee)
- altered or damaged (contact Autec for replacement).

3.8.1 Plates on the transmitting unit

The transmitting unit has three plates.

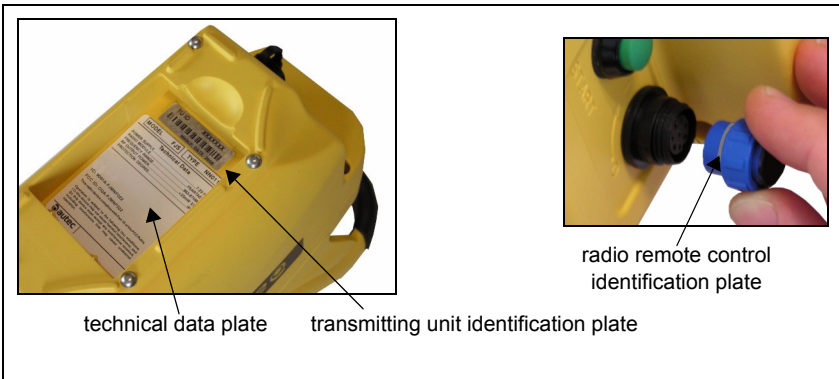

Plate	Position	Content
radio remote control identification plate	On the S-KEY: remove the S-KEY to read the plate.	Radio remote control serial number (S/N).
transmitting unit identification plate	In the battery housing: remove the battery to read the plate.	Manufacturing year, bar code and transmitting unit identification number (TU ID).
technical data plate	In the battery housing: remove the battery to read the plate.	MODEL, TYPE and main transmitting unit technical data, marking and possible radio remote control marks.

3.8.2 Plates on the receiving unit

The receiving unit has two plates.

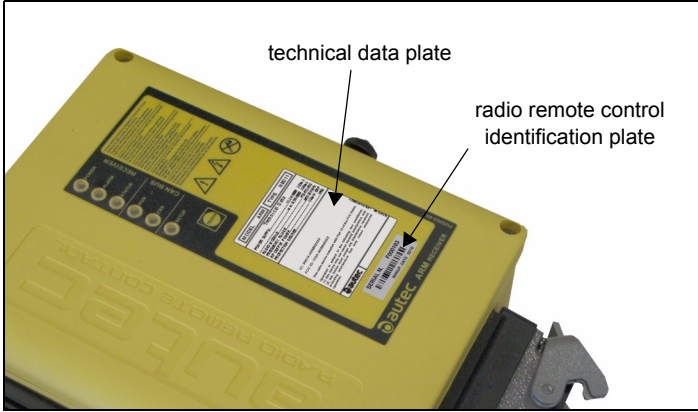

Plate	Position	Content
radio remote control identification plate	On the cover of the receiving unit	Manufacturing year, bar code and radio remote control serial number (S/N).
technical data plate	On the cover of the receiving unit	MODEL, TYPE and main receiving unit technical data, marking and possible radio remote control marks.

4 Risk analysis

As required by the standards, all machines must undergo a risk analysis. It is therefore necessary to evaluate, within the limits of this analysis, if the machine can be radio remote controlled.

The radio remote control can only be used if this analysis gives positive results.

4.1 Risk analysis for radio remote controlled machines

All warnings listed in this manual must also be taken into account during risk analysis and when setting out protection measures for the controlled machine.

When carrying out risk analysis for the machine or for the system where the radio remote control is installed, the following must be considered:

- some machines cannot be radio remote controlled by Dynamic series radio remote controls (see paragraph 3.2)
- the radio link between the two units may be interrupted due to persistent disturbance or interference.

Whenever the radio link is interrupted (i.e. due to active stop, passive stop, low battery, automatic switch off, receiving unit not powered):

- all outputs in the receiving unit are disabled (if this generates a hazardous situation, it is necessary that the corresponding commands are kept active)
- it is not possible to enable or disable the machine commands until the radio remote control is started up again.

Due to the characteristics of radio propagation (i.e.: EM interference, near out-of-range condition), a delay up to the “Passive stop time” (see paragraph 3.7) may occasionally occur from the moment a command in the transmitting unit is released to the moment its corresponding output in the receiving unit is deactivated. Those who decide upon the installation of the radio remote control must make sure that this delay never leads to a dangerous situation in the specific uses.

The transmitting unit housing is manufactured so that it protects the actuators from unintentional activation, while meeting at the same time the operating needs, the comfort requirements and law limits.

Assessment shall be made to establish possible additional protection measures for the actuators (i.e. commands requiring two-hand operation, “dead-man” function) if particular environments, equipment and working modes could cause accidental bumps to the actuators.

The machine manufacturer and/or the person who decides upon radio remote control use and installation is responsible for this risk analysis.

Autec cannot be held responsible if this analysis is not carried out correctly.

If required by the risk analysis, draw up protection measures to prevent, reduce and report potential hazard situations.

4.2 Working conditions

To guarantee correct radio remote control operation, all current regulations regarding safety at work and accident prevention should be respected. All applicable standards and regulations valid in the user country regarding the use of both the machine and the radio remote control must always be respected.

Autec cannot be held responsible if the radio remote control is used in unlawful working conditions.

5 FJS transmitting unit

5.1 Description

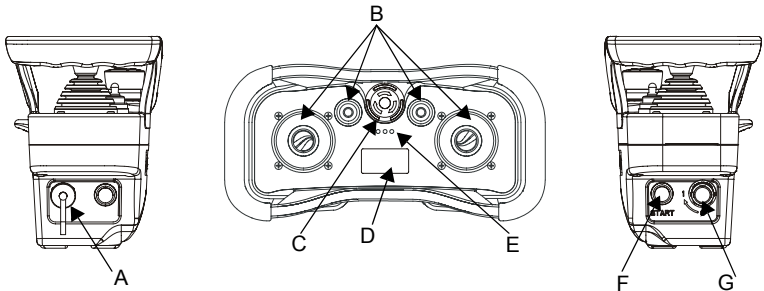

A	connector for wire control (if present)	B	actuators (joysticks, selectors, pushbuttons)
C	STOP pushbutton	D	display or LED (if present)
E	LEDs	F	START pushbutton
G	S-KEY (electronic starting key)		

5.2 Technical data

Power supply (battery MBM06MH).....	NiMH 7.2 V=
Antenna	internal
Housing material	PA 6 (20% fg)
Protection degree	IP65
Dimensions	258 x 170 x 126 mm [10.2" x 6.7" x 5"]
Weight.....	1.3 kg [2.9 lbs]
Run time (at 20°C)	11 h
Run time with Data Feedback (at 20°C)	9.5 h
Run time with Low Power (at 20°C)	14 h
Run time with Data Feedback and Low Power (at 20°C)	12.5 h

5.3 Light signals

FJS transmitting units may have two or three LEDs near the STOP pushbutton.

5.3.1 Light signals with two LEDs

The left LED is green, the right LED is red, and they provide information regarding the radio remote control.

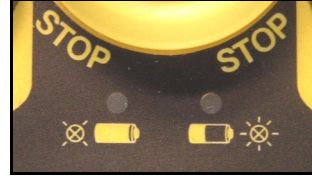

 The green LED ...	Meaning
... is off	The transmitting unit is switched off.
... blinks fast	The transmitting unit is switched on and there is no radio link.
... blinks slowly	The radio remote control is started and the radio link is present.

 The red LED ^a ...	Meaning
... is off	The transmitting unit works correctly.
...blinks	The battery is nearly flat.
... is on for 2 seconds ^b	The transmitting unit does not work correctly.
... blinks once ^b	At power on, the transmitting unit detects that the STOP pushbutton is activated or damaged.
... blinks twice ^b	At power on, the transmitting unit detects that one of the commands D2-D20 or SAFETY is activated or damaged (see technical data sheet).
... blinks three times ^b	At power on, the transmitting unit detects that the battery is flat.
... blinks four times ^b	At power on, the transmitting unit detects that one of the commands A1-A8, L1-L8 and H1-H8 is activated or damaged (see technical data sheet).

- a. An acoustic signal is also heard when the red LED is illuminated.
- b. After this signal, the transmitting unit switches off.

5.3.2 Light signals with three LEDs

Side LEDs are red and provide information coming from the machine (Data Feedback function).

The central LED is bicolour, green and red. The green LED is inhibited when the red one is on: the green LED signals only appear when the red ones pause. The central LED provides information about the radio remote control.

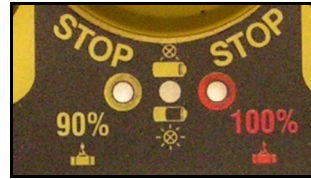

 Central LED is green and it ...	Meaning
... is off	The transmitting unit is switched off.
... blinks fast	The transmitting unit is switched on and there is no radio link.
... blinks slowly	The radio remote control is started and the radio link is present.

 Central LED is red and it ...^a	Meaning
... is off	The transmitting unit works correctly.
...blinks	The battery is nearly flat.
... is on for 2 seconds ^b	The transmitting unit does not work correctly.
... blinks once ^b	At power on, the transmitting unit detects that the STOP pushbutton is activated or damaged.
... blinks twice ^b	At power on, the transmitting unit detects that one of the commands D2-D20 or SAFETY is activated or damaged (see technical data sheet).
... blinks three times ^b	At power on, the transmitting unit detects that the battery is flat.
... blinks four times ^b	At power on, the transmitting unit detects that one of the commands A1-A8, L1-L8 and H1-H8 is activated or damaged (see technical data sheet).

- a. An acoustic signal is also heard when the red LED is illuminated.
- b. After this signal, the transmitting unit switches off.

6 FJL transmitting unit

6.1 Description

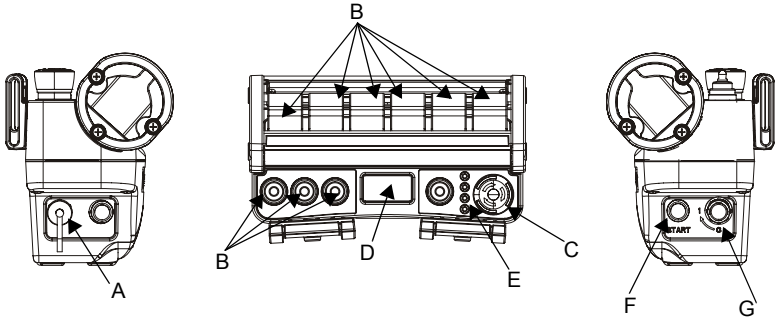





A	connector for wire control (if present)	B	actuators (joysticks, selectors, pushbuttons)
C	STOP pushbutton	D	display or LED (if present)
E	LEDs	F	START pushbutton
G	S-KEY (electronic starting key)		

6.2 Technical data

Power supply (battery MBM06MH).....	NiMH 7.2 V=
Antenna	internal
Housing material	PA 6 (20% fg)
Protection degree	IP65
Dimensions	221 x 170 x 134 mm [8.7" x 6.7" x 5.3"]
Weight.....	1.4 kg [3.1 lbs]
Run time (at 20°C)	11 h
Run time with Data Feedback (at 20°C)	9.5 h
Run time with Low Power (at 20°C)	14 h
Run time with Data Feedback and Low Power (at 20°C)	12.5 h

6.3 Light signals

FJL transmitting units have four LEDs on the left of the STOP pushbutton:

- a green LED, identified with  , providing information about the radio remote control.
- a red LED, identified with  , providing information about the radio remote control.
- two red LEDs (the two lower ones) that may provide information coming from the machine (Data Feedback function).



 The green LED ...	Meaning
... is off	The transmitting unit is switched off.
... blinks fast	The transmitting unit is switched on and there is no radio link.
... blinks slowly	The radio remote control is started and the radio link is present.

 The red LED ^a ...	Meaning
... is off	The transmitting unit works correctly.
...blinks	The battery is nearly flat.
... is on for 2 seconds ^b	The transmitting unit does not work correctly.
... blinks once ^b	At power on, the transmitting unit detects that the STOP pushbutton is activated or damaged.
... blinks twice ^b	At power on, the transmitting unit detects that one of the commands D2-D20 or SAFETY is activated or damaged (see technical data sheet).
... blinks three times ^b	At power on, the transmitting unit detects that the battery is flat.
... blinks four times ^b	At power on, the transmitting unit detects that one of the commands A1-A8, L1-L8 and H1-H8 is activated or damaged (see technical data sheet).

- a. An acoustic signal is also heard when the red LED is illuminated.
- b. After this signal, the transmitting unit switches off.

7 FJM transmitting unit

7.1 Description

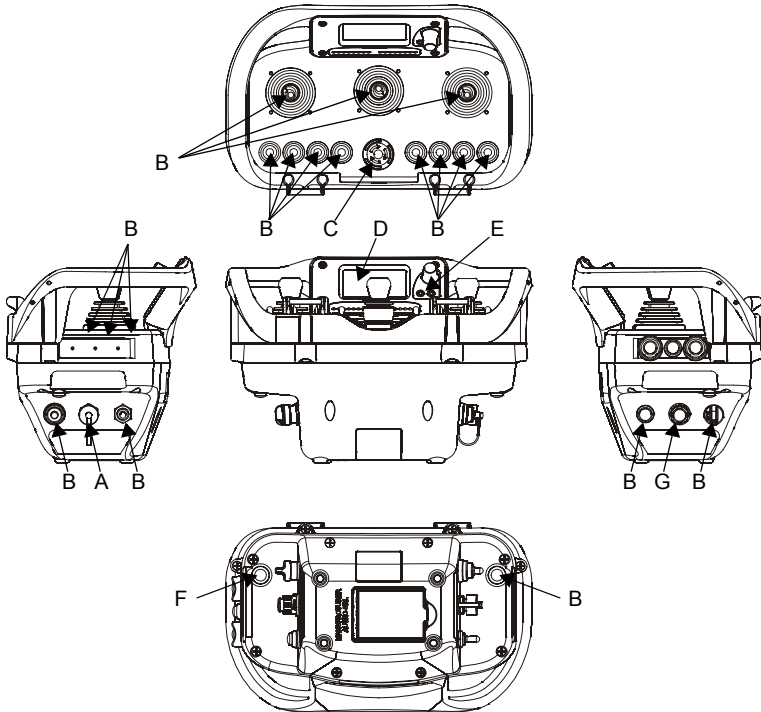

A	connector for wire control (if present)	B	actuators (joysticks, selectors, push-buttons)
C	STOP pushbutton	D	display or LED (if present)
E	LEDs	F	START pushbutton
G	S-KEY (electronic starting key)		

7.2 Technical data

Power supply (battery MBM06MH).....	NiMH 7.2 V=
Antenna	internal
Housing material	PA 6 (20% fg)
Protection degree	IP65
Dimensions	310 x 210 x 190 mm [12.2" x 8.3" x 7.5"]
Weight.....	2.5 kg [5.5 lbs]
Run time (at 20°C)	11 h
Run time with Data Feedback (at 20°C)	9.5 h
Run time with Low Power (at 20°C)	14 h
Run time with Data Feedback and Low Power (at 20°C)	12.5 h

7.3 Light signals

The FJM transmitting units may have two or four LEDs.

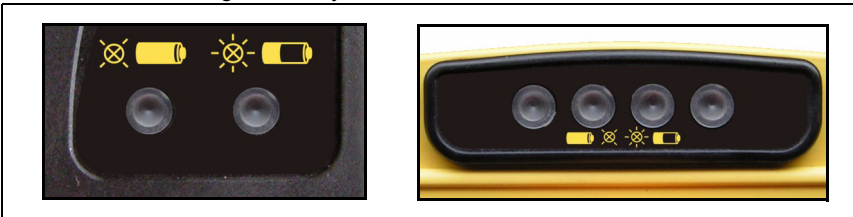

In both cases, two LEDs are always available, providing information regarding the radio remote control.

- a green LED identified with ☒ 🔋
- a red LED identified with 🔋 ☒

☒ 🔋 The green LED ...	Meaning
... is off	The transmitting unit is switched off.
... blinks fast	The transmitting unit is switched on and there is no radio link.
... blinks slowly	The radio remote control is started and the radio link is present.

 The red LED^a ...	Meaning
... is off	The transmitting unit works correctly.
...blinks	The battery is nearly flat.
... is on for 2 seconds ^b	The transmitting unit does not work correctly.
... blinks once ^b	At power on, the transmitting unit detects that the STOP pushbutton is activated or damaged.
... blinks twice ^b	At power on, the transmitting unit detects that one of the commands D2-D20 or SAFETY is activated or damaged (see technical data sheet).
... blinks three times ^b	At power on, the transmitting unit detects that the battery is flat.
... blinks four times ^b	At power on, the transmitting unit detects that one of the commands A1-A8, L1-L8 and H1-H8 is activated or damaged (see technical data sheet).

- a. An acoustic signal is also heard when the red LED is illuminated.
- b. After this signal, the transmitting unit switches off.

If it has 4 LEDs, the side LEDs are red and provide information coming from the machine (Data Feedback function).

8 ARM receiving unit

8.1 Description

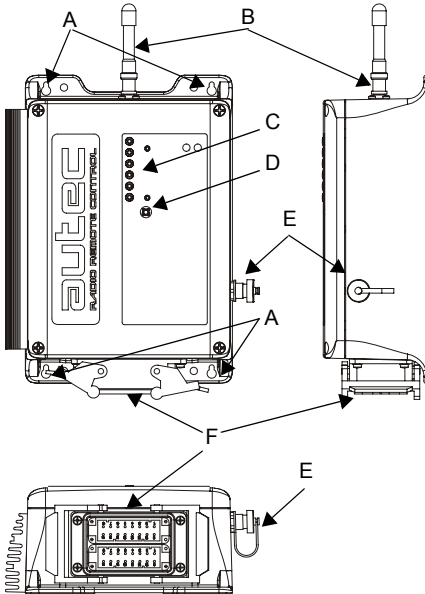

A	mounting holes
B	antenna
C	LEDs
D	TEACH pushbutton
E	connector for cable control
F	plug

The receiving unit communicates with the machine through the outputs and their wiring and/or through a CAN network (of which it is a slave node).

The STOP (STOP_1 and STOP_2) and SAFETY (SAF_1 and SAF_2) outputs are some of the receiving unit's outputs.

8.2 Mother board

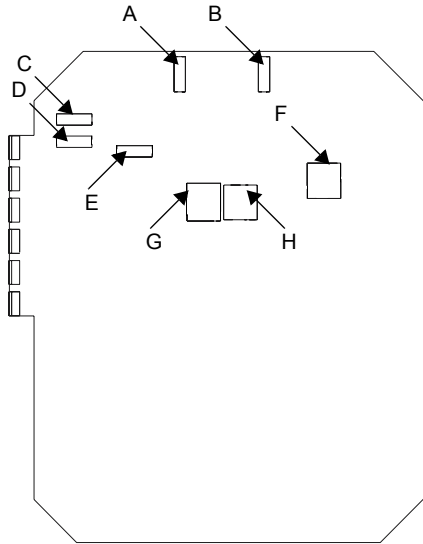

A	fuse F1
B	fuse F2
C	fuse F3
D	fuse F4
E	fuse F5
F	DTK connector (for data memory)
G	IDK (for address key)
H	BKK connector (for backup data memory)

8.3 Technical data

Power supply	8-30 V \approx
Antenna	dedicated
Rated current of outputs STOP_1 and STOP_2	7.5 A (30 V \approx)
Rated current of output SAF_1	7.5 A (30 V \approx)
Rated current of output SAF_2	3 A (30 V \approx)
Rated current of digital outputs	4 A (30 V \approx)
Rated current of analogue outputs (PWM)	2 A (30 V \approx)
Rated current of analogue outputs (voltage)	10 mA (28 V \approx)
Protection SAF_2 (fuse F1)	3 A (32 V \approx , autofuse)
Protection of power supply (fuse F2)	7.5 A (32 V \approx , autofuse)
Protection STOP_1 (fuse F3)	7.5 A (32 V \approx , autofuse)
Protection STOP_2 (fuse F4)	7.5 A (32 V \approx , autofuse)
Protection SAF_1 (fuse F5)	7.5 A (32 V \approx , autofuse)
Housing material	PA6 (30% fg)
Protection degree	IP65
Dimensions	200 x 230 x 95 mm [7.9" x 9.1" x 3.7"]
Weight	3 kg [6.6 lbs]

8.4 Light signals

The ARM receiving unit has six LEDs:

- POWER is green
- ALARM is red
- STATUS is blue
- RUN is green
- ERR is red
- SETUP is yellow.



1. POWER LED (green)

The POWER LED indicates the status of the receiving unit and of the radio link.

The POWER LED ...	Meaning
... is off	The receiving unit is switched off.
...blinks	Radio link has been built.
... is on	No radio link.

2. ALARM LED (red)

The ALARM LED warns about anomalies in the receiving unit.

The ALARM LED ...	Meaning
... is off	The receiving unit works correctly.
... blinks once	Error on the STOP outputs.
... blinks twice	Error on the SAFETY outputs.
... blinks three times	Error on the outputs corresponding to direction commands.
... is on	The receiving unit does not work correctly.

3. STATUS LED (blue)

The STATUS LED warns about anomalies on the outputs or on the power supply and indicates the reception of data from the transmitting unit.

The STATUS LED ...	Meaning
... is off	No radio link.
... blinks slowly	Over-voltage on power supply.
... blinks fast	The receiving unit receives data from the transmitting unit.
... is on	Over-current in one of the PWM analogue outputs.

4. RUN LED (green)

The RUN LED indicates the status of the communication between the receiving unit and the CAN network Master node.

The RUN LED ...	Meaning
... is off	The receiving unit does not work as a CAN network node.
...blinks	The receiving unit does not send commands in the CAN network.
... is on	The receiving unit is working correctly as a node in the CAN network.

RUN LED signals reflect the guidelines of the CANopen®, standard, CiA recommendation 303-3.

5. ERR LED (red)

The ERR LED indicates the status of the CAN communication.

The ERR LED ...	Meaning
... is off	The CAN communication is working correctly.
...blinks	The CAN communication does not work correctly.
... is on	No CAN communication.

ERR LED signals reflect the guidelines of the CANopen® standard, CiA recommendation 303-3.

6. SETUP LED (yellow)

The SETUP LED shows the status of the data memory and of the address key, depending on the receiving unit's working status.

The SETUP LED ...	Meaning
... is off	The receiving unit works correctly.
... blinks once	Error on the address key.
... blinks twice	Error on the data memory.
... blinks three times	The receiving unit is storing the data set through the REMOTE SET UP (see paragraph 13.1) or through the "Data memory backup" (see chapter 14).
... blinks slowly	A data memory is connected to the BKK connector.
... blinks fast	This signal has two meanings, depending on the current working status: <ul style="list-style-type: none"> - the receiving unit is restoring factory settings (see paragraph 13.2) - an error occurred during the "Data memory backup" (see chapter 14).
... is on	The receiving unit is in REMOTE SET UP mode (see paragraph 13.1).

9 Warnings

In addition to all instructions provided by the machine manufacturer, by the installer of the radio remote control and by the person responsible for the safety of the work area, users shall always respect the following warnings.



9.1 Before starting to work

The transmitting unit shall be used in a simple and comfortable way, avoiding accidental falls. The harness provided with the radio remote control serves as such.

Stand in a position that allows the direct supervision of the remote controlled machine and its load, and stay in a place ensuring safety conditions in respect of other operations and/or activities and/or processes that are carried out in the working environment.

Never start up or use the transmitting unit if the working conditions present the risk of losing balance or tripping.

Always check that the mechanical operation of the STOP pushbutton is correct. If it is impossible or difficult to press this pushbutton, do not use the radio remote control.

Only start up the transmitting unit when starting work: improper use may cause hazardous situations.

Never start up or use the transmitting unit in closed spaces, with the machine not in sight, or outside the radio remote control typical working range: in such cases it is in fact still possible to build a radio link, thus causing the risk that unwanted commands be carried out by the machine.



9.2 During normal operation

Visually and directly follow all movements of the machine and its load and remain inside the radio remote control working range.

Pay particular attention to warnings and visual and acoustic signals, and take all measurements and steps to avoid that movements of the remote controlled machine may lead to hazardous situations for people and/or property.

Pay attention to the entire work area. Immediately press the STOP pushbutton when a hazardous situation occurs.

In case of malfunction, disable the system “machine+radio remote control” until the problem has been completely solved.



9.3 After using the radio remote control

Switch off the transmitting unit when work is stopped or temporarily interrupted. Do not leave the load hanging (even when changing the battery).

Never leave the transmitting unit unguarded when the S-KEY is inserted.

Always store the S-KEY in a safe place each time it is removed from the transmitting unit. If this key is lost, the radio remote control cannot work, since the transmitting unit needs the address stored in the key to work with its receiving unit.

10 Radio remote control lifecycle

To ensure a safe and long-lasting operation of Dynamic series industrial radio remote controls, carefully follow the instructions provided for each stage of the product lifecycle.

10.1 Transportation and storage



Radio remote controls must always be transported and stored inside their original packing until they are installed on the machine.

Environmental transportation and storage conditions are given in the following table.

	Temperature	Relative Humidity	Air Pressure
Transportation	Class 2K3 -40°C to +70°C [-40°F to +158°F]	Class 2K3 95%	Class 2K3 70 kPa to 106 kPa
Storage	Class 1K5 -40°C to +80°C [-40°F to +176°F]	Class 1K3 5% to 95%	Class 1K5 70 kPa to 106 kPa

10.2 Installation



The radio remote control can only be installed and tested by competent staff that masters the technical knowledge required to carry out these procedures and is qualified according to the regulation of the country where the radio remote control is mounted.

Only if the radio remote control is installed correctly can it be used safely.



WARNING

Always follow the instructions provided in the technical data sheet to carry out correct installation.



WARNING

Please contact the machine manufacturer or the person who decided upon the installation of the radio remote control for instructions and warnings regarding the installation.



Instructions to calibrate the minimum and maximum values of proportional outputs are reported in chapter 13.

10.3 Use

The use of industrial radio remote controls is strictly limited to skilled and properly trained personnel.



When the radio remote control is installed on mobile machines, switch off the receiving unit when the vehicle travels.

All warnings for a correct use are given in chapter 9.

All instructions for a correct use are given in chapters 11 and 12.

Environmental working conditions are given in the following table.

	Temperature	Relative Humidity	Air Pressure
Transmitting unit	Class 5K4H -25°C to +55°C [-13°F to +131°F]	Class 5K2 5% to 95%	Class 5K2 70 kPa to 106 kPa
Receiving unit	Class 5K2 -25°C to +70°C ^a [-13°F to +158°F]		

- a. The receiving unit can work at 70°C [+158°F] only if the sum of currents corresponding to the loads simultaneously activated by digital and analogue outputs does not exceed 10 A.

10.4 Radio remote control maintenance



The following instructions provide information to safely carry out routine and special maintenance operations for the radio remote control.

They shall be completed by:

- instructions provided by the machine manufacturer
- directions provided by the installer of the radio remote control on the machine
- regulations regarding safety at work and accident prevention in force in the country where the radio remote control is used.

All fine-tuning, checking and maintenance actions carried out on the radio remote control shall be verified and recorded by the person in charge of carrying out maintenance on the machine.



In case of failure, emergencies or damaged parts, disable the system “radio remote control+machine” until the problem has been completely solved.



Before any maintenance operation:

- **remove the battery from the transmitting unit**
- **disconnect power from the receiving unit.**



After any maintenance operation:

- **always make sure that commands sent by the transmitting unit only activate the corresponding expected operations**
- **if a unit has been opened, close it correctly, in order not to endanger its protection degree from dust and water: check that the gasket is intact, correctly overlay the two parts of the housing and tighten the screws.**

10.4.1 Routine maintenance



Routine maintenance consists of operations needed to preserve the radio remote control normal usage conditions, thus implementing fine-tuning, checks, planned replacement actions that necessarily arise from the normal use of the product.

All given instructions must be followed correctly at each commissioning, that is:

- whenever the radio remote control and/or the machine is installed or assembled
- whenever the machine location/position changes
- after special maintenance.

Routine maintenance carried out as described in this manual is fundamental for using the radio remote control safely.

Special applications may need more specific routine maintenance actions to be carried out at different periods (i.e. if the working environment is particularly dirt, in case of heavy applications or if the system is used very frequently, some maintenance actions may be required more frequently, depending on the decision of the person in charge for safety in the worksite).

10.4.2 Daily routine maintenance

Before starting to work:

- make sure that the battery housing and the battery contacts are always clean
- make sure that the gaskets, bellows and caps of the actuators (joysticks, selectors and pushbuttons) are intact, soft and elastic
- make sure that the transmitting unit panel symbols can be easily recognised and replace the panel if necessary
- check that the three plates on the transmitting unit are readable and intact
- make sure that the mechanical operation of the STOP pushbutton is correct.

During normal operation:

- check structural integrity of the transmitting unit
- make sure that materials that could endanger the transmitting unit usage and safety (such as concrete, sand, lime, dust) do not deposit on it.

After using the radio remote control:

- clean the transmitting unit: never use solvents or flammable/corrosive materials and do not use high-pressure water cleaners or steam cleaners
- store the transmitting unit in clean and dry areas.

10.4.3 Three-month routine maintenance

Every three months:

- remove dust or deposit of material from the receiving unit: never use solvents or flammable/corrosive materials to clean it, and do not use high-pressure water cleaners or steam cleaners
- check structural integrity of the receiving unit
- make sure that the wiring of the receiving unit is intact and connected
- make sure that the receiving unit panel symbols can be easily recognised and replace the panel if necessary
- check that the plates on the receiving unit are readable and intact.

10.4.4 Special maintenance



Special maintenance consists of repairs needed due to radio remote control failure, damage or malfunction, carried out with the aim of restoring the original usage and working conditions.

Prior to contacting the support service technicians of the machine's manufacturer:

- read and understand all parts of this manual, and make sure that all the instructions it contains have been accomplished correctly
- follow the instructions to detect possible malfunctions and their origins (see chapter 15).



Any fault should be repaired by authorised personnel only (contact the support service of the machine's manufacturer), using original Autec spare parts only.

The following radio remote control data must be reported in order to make interventions faster and more reliable:

- radio remote control serial number (S/N) and TU ID (transmitting unit identification number)
- purchase date (given on the certificate of guarantee)
- description of the problem found
- address and telephone number of the place where the device is being used (with the name of the person to contact)
- local supplier.

10.5 Machine maintenance

Follow instructions provided by the machine manufacturer and by the installer of the radio remote control, in order to carry out machine maintenance.



When carrying out maintenance operations on the machine:

- **always remove the S-KEY from the transmitting unit**
- **disconnect power from the receiving unit**



Disconnect the plug and the antenna from the ARM receiving unit whenever machine maintenance is carried out (i.e. when soldering).

10.6 Disposal

When disposing of a radio remote control, give it to the waste separate collecting services in the user's country.

Please pay particular attention when recycling the batteries: apply local rules. Do not throw them away with domestic trash.

11 General operating instructions

11.1 Starting up the radio remote control

Starting up the radio remote control consists in building a radio link between the transmitting and the receiving unit. For this purpose, you need to:

1. power on the receiving unit respecting the voltage limits provided in the technical data (see paragraph 8.3). The POWER LED switches on
2. power on the transmitting unit:
 - insert a charged battery in the transmitting unit (see paragraph 12.1)
 - insert the S-KEY in the transmitting unit. The green LED starts blinking fast
3. press the START pushbutton in the transmitting unit until the POWER LED in the receiving unit and the green LED in the transmitting unit start blinking slowly.

11.2 Command activation

With the radio remote control started, act on the joysticks, pushbuttons and switches corresponding to the command to be performed.

The user must be properly trained about the symbols on the transmitting unit panel, to be aware of the matching between actuators and movements on the machine (symbols used are defined by the machine manufacturer according to the functions of the machine).

Some specific commands may be present on the transmitting unit: see paragraph 12.5.

11.3 Data Feedback Function

The user receives information and/or signals concerning the controlled machine by means of the Data Feedback function.

During normal radio remote control operation, pay particular attention to the indications displayed and signalled by the display or through the LEDs: they can be helpful to evaluate the machine working status.



Any information shown and signalled on the display or through the LEDs can never be considered or used as a safety signal or for legal metrology.



When operating and moving the machine, remember that the radio remote control does not intervene autonomously when potential hazard situations are displayed and signalled.

11.3.1 Operation with display

If the transmitting unit has a display, it is possible to show signal icons, measurements collected from the machine and their description.

Information displayed and how it is displayed (icons and/or measurements and/or descriptions) depend on the settings chosen by the machine manufacturer.

In addition, two indicators are always present:

- battery charge level (at the bottom on the left)
- quality of radio link (at the bottom on the right).

11.3.2 Operation with LED

If the transmitting unit has an LED array, particular machine conditions are signalled if they are on (i.e. load limits, limit switch, ...).

The signalled conditions depend on the settings chosen by the machine manufacturer.

11.4 Radio link interruption

When the radio link is incorrect or interrupted for a certain period of time, the passive stop function automatically cuts in (see paragraph 3.6.1).

The green LED on the transmitting unit switches from blinking slowly to fast blinking.

The POWER LED on the receiving unit switches from blinking to steady on.

Press the START pushbutton to start the radio remote control.

11.5 Transmitting unit automatic switch off

The transmitting unit automatically switches off when:

- the battery is flat (see paragraph 11.5.1)
- the radio remote control is not used for a certain time (see paragraph 11.5.2)
- the transmitting unit is powered and never switched off for eight hours non-stop (see paragraph 11.5.3).

The green LED on the transmitting unit switches off.

The POWER LED on the receiving unit switches from blinking to steady on.

Press the START pushbutton to start the radio remote control.

11.5.1 Low battery

The transmitting unit indicates if the battery is not sufficiently charged (the red LED blinks and an acoustic signal sounds).

The transmitting unit automatically switches off after 3.5 minutes from the beginning of the signal.

The battery shall be replaced with a charged one (see paragraph 12.1).

11.5.2 When the transmitting unit is not used

The transmitting unit automatically switches off after the “automatic switch off time” has elapsed; during that time, the unit stays on without movement commands activated.

The activation of this function and its cut-in time are set by the machine manufacturer (see technical data sheet).

11.5.3 Non-stop use

The transmitting unit indicates if it has been used for eight hours non-stop (the red LED blinks and an acoustic signal sounds).

The transmitting unit automatically switches off after 3.5 minutes from the beginning of the signal.

11.6 Switching off the transmitting unit

The transmitting unit shall be switched off each time work is stopped: remove the S-KEY (see paragraph 12.2) and always store it in a safe place.

11.7 Switching off the receiving unit

The receiving unit shall be switched off each time the radio remote control is not used to control the machine. Remove power from the unit to switch it off.



When the radio remote control is installed on mobile machines, switch off the receiving unit when the vehicle travels.

12 Working

12.1 BATTERY



FJS, FJL and FJM transmitting units can only be powered through Autec rechargeable batteries.

See the battery charger manual enclosed in the packaging with the battery charger for any warnings and instructions regarding the batteries.

Batteries shall be inserted in their housing in the transmitting unit, with the technical data plate facing down and their contacts towards the contacts on the transmitting unit.

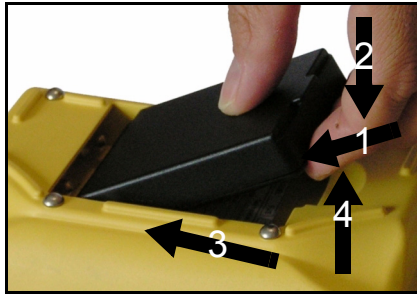

To insert a battery, proceed as follows:

1. push the battery towards the contacts on the transmitting unit
2. push the battery downwards.

To remove a battery, proceed as follows:

3. push the battery towards the contacts on the transmitting unit
4. lift the battery.

12.2 S-KEY

In the transmitting unit, the radio remote control address is stored in the S-KEY. For this reason, the radio remote control cannot work without this key.



The S-KEY can only be used in the transmitting unit of the radio remote control where it belongs (main transmitting unit).



As the radio remote control address is stored in the S-KEY, use it with utmost care to reduce risks that may result from incorrect handling.



If the main transmitting unit cannot be used because it has been lost or damaged, the back-up transmitting unit can be used instead. In this case, insert the S-KEY in the back-up unit. The back-up unit is identical to the main unit; the only difference is the presence of the plate “BACK-UP UNIT” on the battery housing.

12.3 START pushbutton

The START pushbutton is used to:

- start up the radio remote control (see paragraphs 11.1, 11.4 and 11.5)
- activate the horn when the radio remote control is started.



12.4 STOP



The STOP pushbutton should be pressed when it is necessary to stop the machine immediately when a dangerous condition should occur.

When the STOP pushbutton is pressed, the machine stops (active stop: see paragraph 3.6.1), and the transmitting unit switches off.

To start working again after the STOP pushbutton has been pressed:

1. make sure that the working and usage conditions are safe
2. turn the STOP pushbutton in the arrow direction to unlock it
3. start up the radio remote control (see paragraph 11.1).

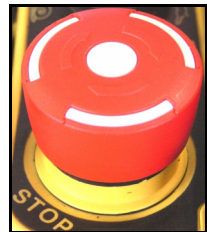

12.5 Command meaning

Commands on the transmitting unit are established according to the machine's operations and functions. They are established by the machine manufacturer, who also chooses the symbols used.

Some of the commands available on the transmitting unit may be those provided below; in this case, symbols used are generally those given here:

RPM+/- (during normal operation)

This switch increases (rpm +) or decreases (rpm -) the engine revolutions of the remote controlled machine.



TEACH (during REMOTE SETUP)

This switch is used to calibrate minimum and maximum values of proportional outputs (see chapter 13).





MOVEMENT SPEED SELECTOR

This switch is used to modify the movement speed. According to the configuration:

- it sets two or three speed levels
- it increases and/or decreases speed.

These three symbols are used:



Symbol	Meaning
	This symbol indicates the typical machine's speed.
	This symbol indicates a reduction in the machine's speed (the reduction is set by the manufacturer).
	This symbol, if present, indicates a further reduction in the machine's speed (the reduction is set by the manufacturer).

ENGINE

This switch is used to switch on and off the engine of the remote controlled machine.



Symbol	Meaning
	This symbol indicates that the engine is powered on.
	This symbol indicates that the engine is switched off.

DISPLAY pushbutton (if the transmitting unit has a display)

This pushbutton is used to:

- activate the display lighting, if it is off
- cyclically scroll the information on the display in two different modes:
 - manual: the lines scroll up each time the pushbutton is pressed
 - automatic: when the DISPLAY pushbutton is pressed for 3 seconds, the lines scroll automatically. If the DISPLAY pushbutton is pressed another time, it switches back to manual mode.



It is not possible to scroll the lines if only icons are displayed. The display lighting stays on for a time set by the machine manufacturer.

12.6 Low Power function

The LOW POWER function allows transmission at a lower power than the nominal power (see paragraph 3.7) and reduces the radio remote control working range.

This function aims at:

- making it easier to work with several systems in the same working environment (i.e.: many working machines in the same working area)
- extending the battery run-time.

This function is established by the machine manufacturer (see technical data sheet).

12.7 Wire control

The wire control is used:

- in particular working conditions, established by the machine manufacturer
- when it is not possible to build a radio link between the radio remote control units
- when working in environments where using radio frequencies is not allowed or is dangerous
- when a fully charged battery is not available.



When using the wire control, it is not possible to eliminate the electric shock hazard when working near in-ground or overhead high voltage electrical cables.

12.7.1 Description

The wire control connects the transmitting unit to the receiving unit through a cable that replaces the radio link. The cable must be plugged in its connector on the transmitting unit and on the receiving unit.



Connector on the transmitting unit



Connector on the receiving unit

When using the wire control, the working features do not change (i.e. the meaning of actuators and the Data Feedback function).

12.7.2 Working



CAUTION

Before starting to work, make sure that the cable and the corresponding connectors are intact.

The wire control can only be connected and disconnected when the transmitting unit is switched off.

After connecting or disconnecting the wire control, start up the radio remote control (see paragraph 11.1) to control the machine.

During operation with wire control:

- radio link is off
- leave the battery inside the transmitting unit, even though the power supply comes from the receiving unit.

The battery is not, in any case, recharged through the wire control: it can only be recharged through its appropriate battery charger provided together with the system.



When you finish working with the cable control, disconnect the cable from the transmitting unit and from the machine, and protect the connectors on the units with their caps.

13 Values of proportional outputs

Proportional outputs in the ARM receiving unit are factory set: values are given in the technical data sheet. Maximum and minimum values of proportional outputs (joystick semi-axes) can be modified using the REMOTE SETUP procedure (see paragraph 13.1). After modifying the values it is possible to restore factory settings, if necessary.

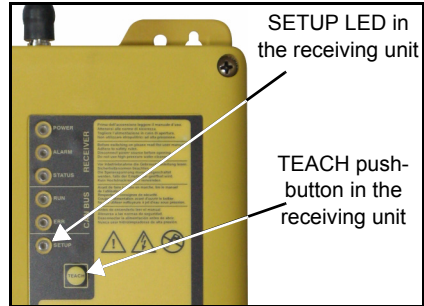

13.1 REMOTE SETUP procedure



Proportional outputs can only be calibrated by qualified and trained personnel.

This calibration is used to set maximum and minimum values for the semi-axes of each joystick.

1. Ensure that the transmitting unit is switched off.
2. Power on the receiving unit.
3. Press the TEACH pushbutton in the receiving unit and do not release it until the SETUP LED illuminates.
4. Insert the S-KEY in the transmitting unit.
5. Set the maximum and minimum value for the semi-axes of each joystick to be calibrated, as described here below:
 - press the START pushbutton in the transmitting unit
 - to set the maximum value, move the joystick to the maximum range of the semi-axis to be calibrated. Maintain the position and use the TEACH selector on the transmitting unit to set the desired value.
 - to set the minimum value, move the joystick slightly out from the standstill position of the semi-axis to be calibrated. Maintain the position and use the TEACH selector on the transmitting unit to set the desired value.
 - after calibrating one joystick in the transmitting unit, press the STOP pushbutton to save calibrations.

Calibrations are saved in the data memory on the DTK connector.

6. To leave the procedure, press the TEACH pushbutton on the receiving unit and do not release it until the SETUP LED switches off.



Check that the new values of proportional outputs correctly fit the machine operation and then save a copy of the data memory (see chapter 14).



If a speed selector is present on the transmitting unit, calibration is to be performed for each of the selector positions.



CAUTION

If inputs of the module FSAAMI01A are used in the receiving unit to select different speeds, calibration must be performed while these inputs are active.

13.2 Restoring factory settings

This procedure is used to restore factory settings for the proportional outputs.

1. Ensure that the transmitting unit is switched off.
2. Power on the receiving unit.
3. Press the TEACH pushbutton and do not release it until the SETUP LED illuminates.
4. Press the TEACH pushbutton three times and do not release it at last pressure; the SETUP LED blinks fast: this indicates that factory settings are being restored.
5. Release the TEACH pushbutton when the SETUP LED is steadily illuminated again.

If the TEACH pushbutton is released before the SETUP LED is steadily illuminated, factory settings of proportional outputs will not be restored.

6. To leave the procedure, press the TEACH pushbutton on the receiving unit and do not release it until the SETUP LED switches off.

14 Data memory backup

The receiving unit has two data memories: one is in the DTK connector on the mother board and one is attached inside the cover (backup data memory). When data of proportional outputs are modified, they are saved in the data memory present in the DTK connector.

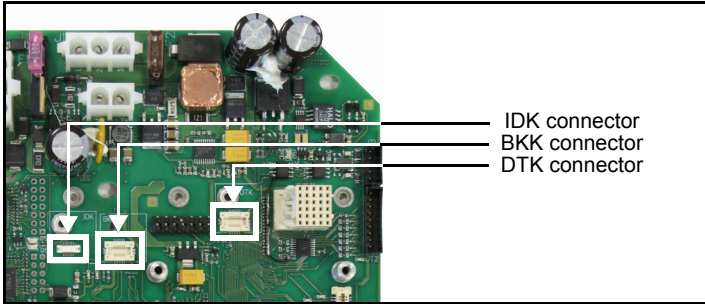

The data memory in the DTK connector can be copied into a backup data memory. This is useful in case you need to restore the information contained. In this case, use the data memory attached inside the cover.



If one of the data memories is lost or damaged, ask the machine manufacturer for a new one.



Please note that information contained in the data memory in the DTK connector overwrites the data memory of the BKK connector during the backup procedure.

Perform the following steps to copy the information of the data memory.

1. Make sure that the transmitting unit and the receiving unit are not powered.
2. Open the receiving unit
3. Make sure that a data memory is plugged in the DTK connector
4. Insert the memory attached inside the receiving unit cover in the BKK connector
5. Close the receiving unit
6. Power on the receiving unit: the SETUP LED blinks slowly
7. Press the TEACH pushbutton: the SETUP LED blinks fast (indicating that data are being copied); release the button when the LED starts blinking slowly again. If the TEACH pushbutton is released before the SETUP LED starts blinking slowly again, data contained in the data memory will not be copied.
8. Disconnect power from the receiving unit.
9. Open the receiving unit, remove the data memory from the BKK connector and attach it inside the cover.
10. Close the receiving unit.

15 Troubleshooting

When the radio remote control does not work:

- bring the transmitting unit close to the receiving unit to avoid radio interference and disturbances
- establish whether the problem lies with the radio remote control or with the machine.

Therefore, before any inspection, try to control the machine from a control unit different from the radio remote control, if present.

If the problem persists, it lies with the machine.

If not, the problem may lie with the radio remote control. In such case, please refer to paragraph 15.3.

15.1 Radio remote controls with Data Feedback function

It is still possible that the transmitting unit sends commands to control the machine even though the Data Feedback function does not work properly, or if there is no information and/or signals coming from it.

To check that the radio remote control works properly, please refer to paragraph 15.3.



CAUTION

When the display or the LED array does not work, please contact the support service of the machine manufacturer, even if no one of the problems indicated in paragraph 15.3 has been detected.

15.2 Radio remote controls with wire control

Please refer to paragraph 15.3 to check that the radio remote control works properly.

Possibly use the wire control to check if radio interference occurs.

On the contrary, if you want to check that the wire control works properly:

- connect the cable to the transmitting unit and to the machine
- check that the manoeuvres carried out by the machine correspond to the commands sent by the transmitting unit.

15.3 Solutions in case of malfunction

Identify the radio remote control malfunction according to the light signals on the units. If the problem persists after the suggested solution has been carried out, contact the support service of the machine manufacturer.

15.3.1 Malfunction signalled by the transmitting unit

Signals	Possible reason	Solutions
The green LED does not switch on when the START pushbutton is pressed, even though both the battery and the S-KEY are inserted.	The battery is flat.	Replace the battery with a charged one.
The green LED blinks fast.	No radio link.	Bring the transmitting unit close to the receiving unit.
The red LED switches on for 2 seconds and then the unit switches off.	The transmitting unit does not work correctly.	Contact the support service of the machine manufacturer.
The red LED blinks once during start up.	The STOP pushbutton is locked or damaged.	Unlock the STOP pushbutton. If this signal persists, contact the support service of the machine manufacturer.
The red LED blinks twice during start up.	At least one of the actuators corresponding to commands D2-D20 is activated or damaged.	Bring the actuators to the rest position. If this signal persists, contact the support service of the machine manufacturer.
The red LED blinks three times during start up.	The battery is flat.	Replace the battery with a charged one.
The red LED blinks four times during start up.	At least one of the actuators corresponding to commands A1-A8 and H1-H8 is activated or damaged.	Bring the actuators to the rest position. If this signal persists, contact the support service of the machine manufacturer.

15.3.2 Malfunction signalled by the receiving unit

Signals	Possible reason	Solutions
The POWER LED is off.	The receiving unit is switched off.	Make sure that fuse F2 is intact. Correctly plug in the connecting plug and power on the receiving unit.
The POWER LED is on.	No radio link.	Bring the transmitting unit close to the receiving unit.
The ALARM LED blinks once.	Error on the STOP outputs.	Make sure that fuses F3 and F4 are intact. Correctly plug in the connecting plug. Make sure that the STOP outputs are wired correctly.
The ALARM LED blinks twice.	Error on the SAFETY outputs.	Make sure that fuses F1 and F5 are intact. Correctly plug in the connecting plug. Make sure that the SAFETY outputs are wired correctly.
The ALARM LED blinks three times.	Error on the outputs of direction commands.	Contact the support service of the machine manufacturer. Make sure that the outputs of direction commands are wired correctly.
The ALARM LED is on.	The receiving unit does not work correctly.	Contact the support service of the machine manufacturer.
The STATUS LED blinks slowly.	Over-voltage on power supply.	Make sure that the receiving unit power supply is within the voltage limits provided in the technical data.
The STATUS LED blinks fast and irregularly.	The receiving unit loses some data sent by the transmitting unit.	Bring the transmitting unit close to the receiving unit. If this signal persists, contact the support service of the machine manufacturer.
The STATUS LED is on.	Over-current in one of the PWM analogue outputs.	Contact the support service of the machine manufacturer.
The RUN LED blinks.	The receiving unit does not send commands in the CAN network.	Contact the support service of the machine manufacturer.
The ERR LED blinks.	CAN communication error.	Contact the support service of the machine manufacturer.

Signals	Possible reason	Solutions
The SETUP LED blinks once.	Error on the address key.	Contact the support service of the machine manufacturer.
The SETUP LED blinks twice.	Error on the data memory.	Replace the data memory on the DTK connector with the backup data memory attached inside the cover (see chapter 14).
The SETUP LED blinks slowly.	A data memory is connected to the BKK connector.	If you are not performing a backup of the data memory, remove the memory from the BKK connector (see chapter 14).

