

Instruction Manual for the use and the maintenance of the Radio Remote Control

Original instructions

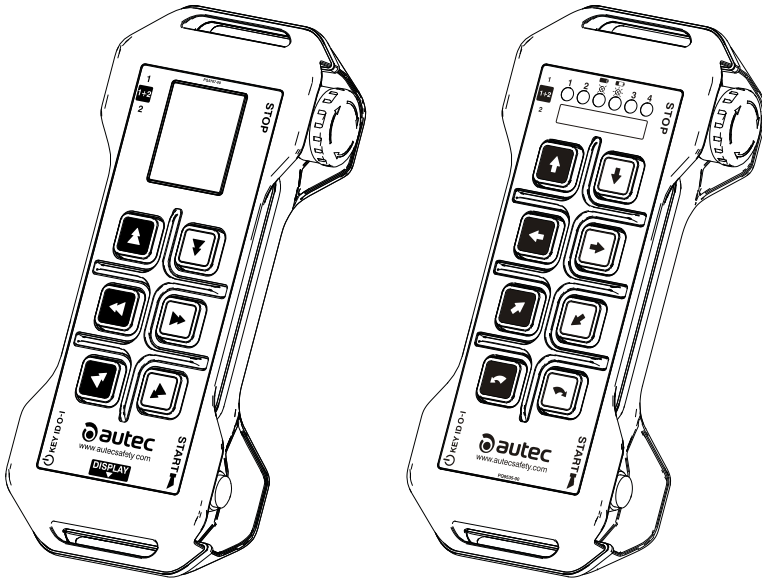

**Part C: LK NEO 6, LK NEO 8 and LK NEO 6 DF
(Model LKN Type LA1CM, DA1DM)
Transmitting Unit**

AIR SERIES



THIS PART OF THE MANUAL CONSISTS OF: Part C - Information, instructions and warnings for the LK NEO 6, LK NEO 8 and LK NEO 6 DF (Model LKN Type LA1CM, DA1DM) Transmitting Unit. The Manual consists of Part A – General, Part B – Conformity and Frequencies, Part C – Transmitting Unit, Part D – Receiving Unit, Part E – Battery and Battery Charger, plus the Technical Data Sheet.

THIS MANUAL, INCLUDING ALL PARTS THEREOF, AND ALL INSTRUCTIONS CONTAINED HEREIN, MUST BE READ CAREFULLY AND UNDERSTOOD BEFORE INSTALLING, USING, MAINTAINING OR REPAIRING THE AUTEC RADIO REMOTE CONTROL.

FAILURE TO READ AND COMPLY WITH ALL APPLICABLE WARNINGS AND INSTRUCTIONS OR ANY ONE OF THE LIMITATIONS NOTED IN THIS MANUAL CAN RESULT IN SERIOUS BODILY INJURY OR DEATH, AND/OR PROPERTY DAMAGE.

THE AUTEC RADIO REMOTE CONTROL IS NOT A STANDALONE PRODUCT AND IS INTENDED ONLY AS A COMPONENT ON A MACHINE:

- **ON WHICH AND WHERE THE USE OF A RADIO REMOTE CONTROL IS APPROPRIATE,**
- **THAT CAN BE OPERATED SAFELY AND IN ACCORDANCE WITH ALL APPLICABLE LAWS, REGULATIONS AND STANDARDS BY SUCH REMOTE CONTROL.**

ACCORDINGLY, IT IS THE RESPONSIBILITY OF THE MACHINE MANUFACTURER ON WHICH THE AUTEC REMOTE CONTROL IS INTENDED TO BE INSTALLED, to perform an in-depth and accurate risk assessment to determine if the Autec Radio Remote Control is suitable for operating a Machine in conditions of safety and operational effectiveness, taking into account the conditions of use, the intended uses and the reasonably foreseeable incorrect ones, so that the installation, maintenance and use of the Autec Radio Remote Control, and all its components, are performed only and entirely in compliance with this Manual and in accordance with all local regulations, safety standards and regulations (referred to herein as "Laws, Regulations and Standards").

With reference to the USA market the Laws, Regulations and Standards include all safety rules and regulations of the Occupational Safety & Health Administration (OSHA) (<http://www.osha.gov>), all federal, state and local laws, regulations and building and electrical codes, and all applicable standards, including but not limited to ANSI Standards.

It is also the responsibility of the Manufacturer and of the design professionals of the Machine on which the Autec Radio Remote Control is to be installed and used to be certain that the structure, condition, organization and markings of the Machine as installed at the facility is appropriate for and will allow for the safe and reliable use and control of the Machine through the Autec Radio Remote Control interface.

IT IS THE RESPONSIBILITY OF THE OWNER AND FACILITY OPERATOR, AND THEIR DESIGN PROFESSIONALS, that the installation, maintenance and operation of the Autec Radio Remote Control and all of its components are done solely and completely in accordance with this Manual, and with all applicable Laws, Regulations and Standards, even local. It is also the responsibility of the Manufacturer of the Machine on which the Autec Radio Remote Control is to be installed and used, and their design professionals, to be certain that the structure, condition, organization and markings of the Machine as installed at the facility is appropriate for and will allow for the safe and reliable use and control of the Machine through the Autec Radio Remote Control interface.

ONLY QUALIFIED AND PROPERLY TRAINED PERSONNEL SHOULD BE PERMITTED TO OPERATE OR USE THE AUTEC RADIO REMOTE CONTROL AND THE MACHINE OPERATED BY OR THROUGH THE AUTEC RADIO REMOTE CONTROL. ONLY QUALIFIED AND PROPERLY TRAINED PERSONNEL SHOULD BE PERMITTED TO BE IN THE VICINITY OF MACHINE OPERATED BY OR THROUGH THE AUTEC RADIO REMOTE CONTROL.

FAILURE TO PROPERLY INSTALL, OPERATE, MAINTAIN AND SERVICE THE AUTEC RADIO REMOTE CONTROL CAN RESULT IN SERIOUS BODILY INJURY OR DEATH AND/OR PROPERTY DAMAGE. Refer to this Manual and each of its Parts for further assistance or contact Autec. Autec is not responsible for and shall not be held liable for any installation of the Autec Radio Remote Control not performed by Autec or for any use of the Autec Radio Remote Control not in complete compliance with, and/or not maintained in complete compliance with, all Autec instructions and warnings and all applicable Laws, Regulations and Standards, even local.

Autec is not responsible for and shall not be held liable for any alteration or modification of the Autec Radio Remote Control, or the use of non-Autec components or products used with or incorporated into the Autec Radio Remote Control.

IT IS THE RESPONSIBILITY OF THE OWNER AND FACILITY OPERATOR, AND THEIR DESIGN PROFESSIONALS, to be certain that the Autec Radio Remote Control is properly maintained and serviced at all times in compliance with all Autec instructions and warnings, and with all applicable Laws, Regulations and Standards, even local.

IT IS THE RESPONSIBILITY OF THE OWNER AND FACILITY OPERATOR, AND THEIR OFFICERS, MANAGERS AND SUPERVISORS, to be certain that all Users of the Autec Radio Remote Control and that all Persons who are or will be working with or near the Machine operated by or through the Autec Radio Remote Control are fully and properly educated and trained by qualified Personnel in the proper and safe use of the Autec Radio Remote Control and of the Machine, including without limitation complete familiarity with and understanding of Autec warnings and instructions, and all applicable Laws, Regulations and Standards, even local, and that such Users and other Persons do in fact at all times operate or work with the Autec Radio Remote Control safely and ONLY in compliance with Autec instructions and warnings and with all applicable Laws, Regulations and Standards, even local. FAILURE TO DO SO CAN RESULT IN SERIOUS BODILY INJURY OR DEATH AND/OR PROPERTY DAMAGE.

IT IS THE RESPONSIBILITY OF THE OWNER AND FACILITY OPERATOR, AND THEIR OFFICERS, MANAGERS AND SUPERVISORS, to be certain that the areas in which the Machine operated by or through the Autec Radio Remote Control is located and operates are clearly delineated and marked in accordance with all Autec warnings and instructions, and all applicable Laws, Regulations and Standards, even local, and otherwise sufficient to alert and warn ALL PERSONS that the Machine is operated by or through a Radio Remote Control, and prohibiting any unauthorized access thereto. FAILURE TO DO SO CAN RESULT IN SERIOUS BODILY INJURY OR DEATH AND/OR PROPERTY DAMAGE.

FAILURE TO OPERATE THE AUTEC RADIO REMOTE CONTROL SAFELY AND IN COMPLIANCE WITH AUTEC INSTRUCTIONS AND WARNINGS AND WITH APPLICABLE LAWS, REGULATIONS AND STANDARDS, EVEN LOCAL, AND/OR PERMITTING USERS OR OTHER PERSONS NOT PROPERLY TRAINED IN THE SAFE AND PROPER USE OF THE SYSTEM, OR THE MACHINE ON WHICH IT IS INSTALLED, CAN RESULT IN SERIOUS BODILY INJURY OR DEATH AND/OR PROPERTY DAMAGE.

INDEX

| | | |
|----------|--|-----------|
| 1 | Information on the use of instructions | 8 |
| 1.1 | Structure of the Instruction Manual | 8 |
| 1.2 | Caption and terminology | 10 |
| 1.3 | Symbols | 10 |
| 1.4 | To whom the instructions are addressed | 11 |
| 1.5 | Instruction storage | 11 |
| 1.6 | Intellectual property | 11 |
| 2 | Brief product presentation | 12 |
| 2.1 | Series, Radio Remote Control and Unit | 12 |
| 2.2 | Conformity with standards | 12 |
| 2.3 | Contacts and useful addresses | 12 |
| 2.4 | Warranty | 12 |
| 2.5 | Technical assistance and spare parts | 12 |
| 3 | Description of the Transmitting Unit | 13 |
| 3.1 | Description of LK NEO 6 and LK NEO 8 Transmitting Units (Model LKN Type LA1CM) | 13 |
| 3.2 | Description of LK NEO 6 DF Transmitting Unit (Model LKN Type DA1DM) .. | 14 |
| 4 | Technical data | 15 |
| 4.1 | Technical data of LK NEO 6 and LK NEO 8 transmitting units (Model LKN Type LA1CM) | 15 |
| 4.2 | Technical data of LK NEO 6 DF transmitting unit (Model LKN Type DA1DM) .. | 15 |
| 5 | Technical Data Sheet | 15 |
| 6 | Plates | 16 |
| 6.1 | Plates on the LK NEO 6, LK NEO 8 and LK NEO 6 DF (Model LKN Type LA1CM, DA1DM) Transmitting Unit in a Radio Remote Control | 16 |
| 6.2 | Plates on the LK NEO 6, LK NEO 8 and LK NEO 6 DF (Model LKN Type LA1CM, DA1DM) Transmitting Unit in a "Take & Release" Radio Remote Control | 16 |
| 6.3 | Plates on the LK NEO 6, LK NEO 8 and LK NEO 6 DF (Model LKN Type LA1CM, DA1DM) Transmitting Unit in a "Multi Units" or "Multi Receiver" Radio Remote Control | 17 |
| 7 | Light signals | 18 |
| 7.1 | Light signals on LK NEO 6 and LK NEO 8 Transmitting Units (Model LKN Type LA1CM) | 18 |
| 7.2 | Light signals on the LK NEO 6 DF Transmitting Unit (Model LKN Type DA1DM) | 21 |
| 8 | General operating instructions | 24 |
| 8.1 | Power keyswitch | 24 |
| 8.2 | START pushbutton | 25 |
| 8.3 | STOP pushbutton | 25 |
| 8.4 | FUNCTION pushbutton | 25 |
| 8.5 | DISPLAY pushbutton (if the Transmitting Unit has a display) | 25 |
| 8.6 | Enabling switch | 26 |
| 8.7 | Battery | 27 |
| 8.8 | ID internal tx memory | 28 |
| 8.9 | Zero-G sensor | 29 |

| | | |
|-----------|---|-----------|
| 8.10 | Vibration alarm | 29 |
| 8.11 | Starting up the Radio Remote Control | 30 |
| 8.12 | Command activation | 32 |
| 8.13 | Radio link interruption | 32 |
| 8.14 | Transmitting Unit automatic switch off | 32 |
| 8.15 | Switching off the Transmitting Unit | 33 |
| 8.16 | "Data Feedback" function | 34 |
| 8.17 | BACK-UP UNIT | 35 |
| 9 | Instructions for the User | 37 |
| 9.1 | Usage restrictions | 37 |
| 9.2 | User behaviour | 37 |
| 9.3 | Belt and pouch with belt | 39 |
| 10 | Maintenance | 44 |
| 11 | Malfunction signalled by the Transmitting Unit | 44 |
| 12 | Decommissioning and disposal | 46 |

1 Information on the use of instructions



Before reading this part of the Manual, you must read and understand the general part (Part A) of the Manual provided with the Radio Remote Control.

1.1 Structure of the Instruction Manual

The Manual for the use and maintenance of Autec Air series Radio Remote Controls consists of different parts, that altogether form the Manual; the Manual must be read carefully, understood and applied by the Radio Remote Control's Owner, User and by all those Persons that, for any reasons, may operate with the Radio Remote Control or with the Machine where it is installed. The following table describes the structure of the Instruction Manual for the use and the maintenance of the Radio Remote Control.

| Part | Title | Contents |
|------|-----------------------------|--|
| A | General part | <ul style="list-style-type: none"> - General information regarding the series, - directions for risk assessment of the "Machine+Radio Remote Control" system, - warnings for installation of the Radio Remote Control, - warnings for use and maintenance of the Radio Remote Control, - instructions for correct transportation and storage of Radio Remote Control. |
| B | Conformity and frequencies | <ul style="list-style-type: none"> - Operating frequency bands of the Radio Remote Control, - conformity and law references of the Radio Remote Control. |
| C | Transmitting Unit | Description and instructions concerning the Transmitting Unit, including: <ul style="list-style-type: none"> - description of operation, - commands, - light signals, - malfunctions, - additional instructions to the general part. |
| D | Receiving Unit | Description and instructions concerning the Receiving Unit, including: <ul style="list-style-type: none"> - description of operation, - light signals, - malfunctions, - additional instructions to the general part. |
| E | Battery and Battery Charger | Description, warnings and instructions concerning batteries and Battery Chargers, including: <ul style="list-style-type: none"> - description of operation, - light signals, - malfunctions, - instructions for the User. |

Usage and maintenance instructions are supplemented by the Radio Remote Control's Technical Data Sheet, that:

- describes the Transmitting Unit's configuration,
- indicates the relation between commands sent by the Transmitting Unit and those available on the Receiving Unit.

Usage and maintenance instruction as a whole are to be considered as an integral part both of the Autec Radio Remote Control and of the Machine, system, device or Machinery system where the Radio Remote Control is installed.

The Manufacturer of the Machine on which the Autec Radio Remote Control is installed, and the Owner and User of the Machine, must make sure that the Instruction Manual and all of its parts are included in the Instruction Manual of the Machine.

| | |
|---|---|
|  | The CD attached to each Instruction Manual includes the translations of the Manual. |
|---|---|

Act as follows to identify the single Manual parts in the relevant language in the CD:

- identify the correct section depending on the Radio Remote Control serial number,
- choose the desired language,
- select the single parts of the Manual: refer to the code name provided on the cover of each part.

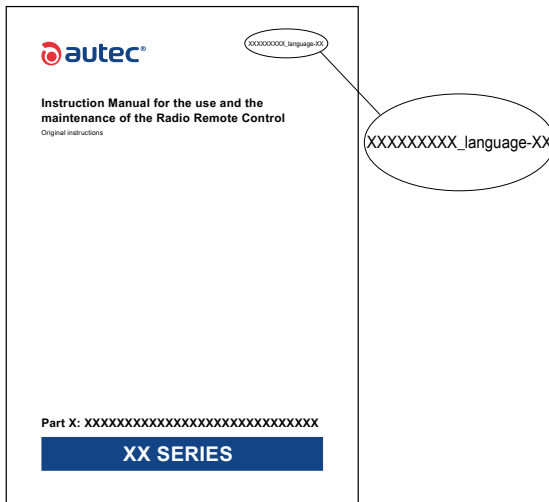

1.2 Caption and terminology

| | |
|---|---|
|  | Contact Autec if any of the instructions, symbols, warnings or images are not clear and understandable, or if you have doubts or questions. |
|---|---|

In this part of the Manual, the terms listed below have the same meaning explained in the corresponding paragraph of the general part (Part A):

- **Unit**
- **Radio Remote Control**
- **Transmitting Unit**
- **Receiving Unit**
- **Machine**
- **Manufacturer**
- **Installer**
- **User**
- **Maintenance Technician**
- **Manual or Instruction Manual**
- **Installation Manual**
- **Person**
- **Owner**

Functions indicated for the Manufacturer, the Installer, the User and the Maintenance Technician may be performed by a single Person, if he/she has the needed competence and undertakes the resulting responsibilities. Each Person must be aware of the instructions contained in the Manual, depending on the activity they carry out.

For example, if a Manufacturer is also the Installer, and/or Maintenance Technician, he must also know and follow the instructions specifically addressed to those Persons. The same applies, for example, if a User is also the Manufacturer and/or the Installer.

1.3 Symbols

| | |
|---|--|
|  | This symbol identifies the parts of text in the Manual that must be read with special attention. |
|---|--|

| | |
|---|---|
|  | This symbol identifies the parts of text in the Manual containing warnings, information and/or instructions that are particularly relevant with regards to safety; failure in understanding them may cause hazards for People and/or property. |
|---|---|

1.4 To whom the instructions are addressed

Addressees of instructions are listed in the paragraph with the same title in the general part: please refer to that part.

1.5 Instruction storage

Regulation for the storage of instructions are described in the paragraph with the same title in the general part: please refer to that part.

1.6 Intellectual property

Restrictions connected to intellectual property are described in the paragraph with the same title in the general part: please refer to that part.

2 Brief product presentation

2.1 Series, Radio Remote Control and Unit

The object of this part of the Manual is the LK NEO 6, LK NEO 8 and LK NEO 6 DF (Model LKN Type LA1CM, DA1DM) Transmitting Unit of an Autec Air series' Radio Remote Control. Autec Air series' Radio Remote Controls are designed to be used on Machines and provide a command interface to their command and control system, to be used from an appropriate distance and position.

2.2 Conformity with standards

The conformity of Radio Remote Controls with standards and with working requirements and conditions in the single Countries is provided in the related specific part "Conformity and frequencies" (Part B) of the Manual.

2.3 Contacts and useful addresses

The Radio Remote Controls are produced by Autec srl – Via Pomaroli, 65 – 36030 Caldogno (VI) – ITALY.

You can find contacts for Autec, its distributors, dealers and authorized service centres on the website www.autecsafety.com.

2.4 Warranty

General warranty conditions are indicated both in the relevant sheet provided together with this documentation, and in the specific page on the website www.autecsafety.com.

2.5 Technical assistance and spare parts

If you need technical services and/or spare parts, please refer to contacts provided in the website www.autecsafety.com.

When applying for technical service to Autec, its distributors, dealers and authorized service centres, the Radio Remote Control's serial number is required; you can find it on the identification plate on the Transmitting Unit and/or on the Receiving Unit.

3 Description of the Transmitting Unit

3.1 Description of LK NEO 6 and LK NEO 8 Transmitting Units (Model LKN Type LA1CM)

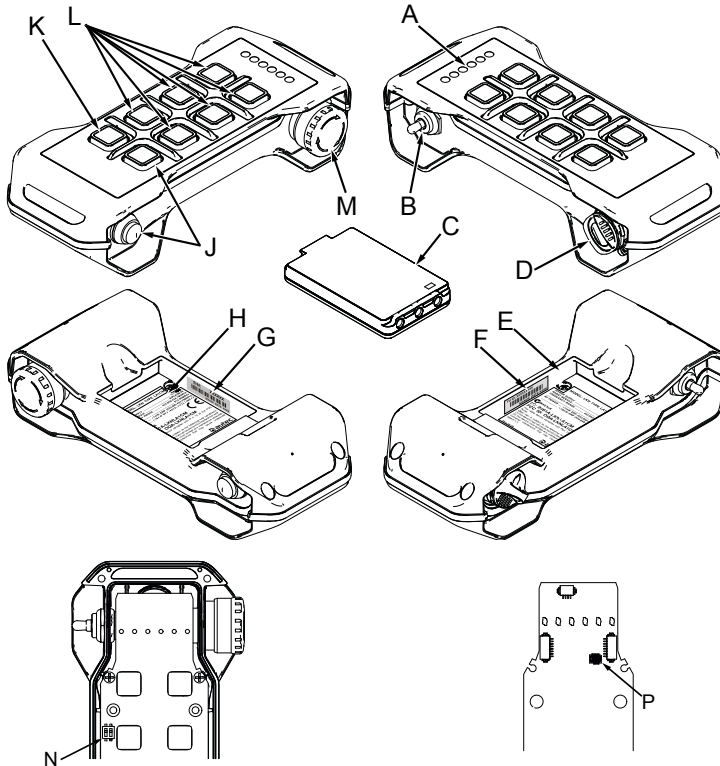

| | |
|---|--|
| A | LEDs |
| B | Actuator (selector, pushbutton) (if present) |
| C | Battery |
| D | Power keyswitch (if present) |
| E | Battery housing |
| F | Transmitting Unit identification plate |
| G | Radio Remote Control identification plate |

| | |
|---|---------------------------------------|
| H | Technical data plate |
| J | START pushbutton |
| K | FUNCTION pushbutton |
| L | Command pushbuttons |
| M | STOP pushbutton |
| N | DIP switches |
| P | Connector for "ID internal tx memory" |

3.2 Description of LK NEO 6 DF Transmitting Unit (Model LKN Type DA1DM)

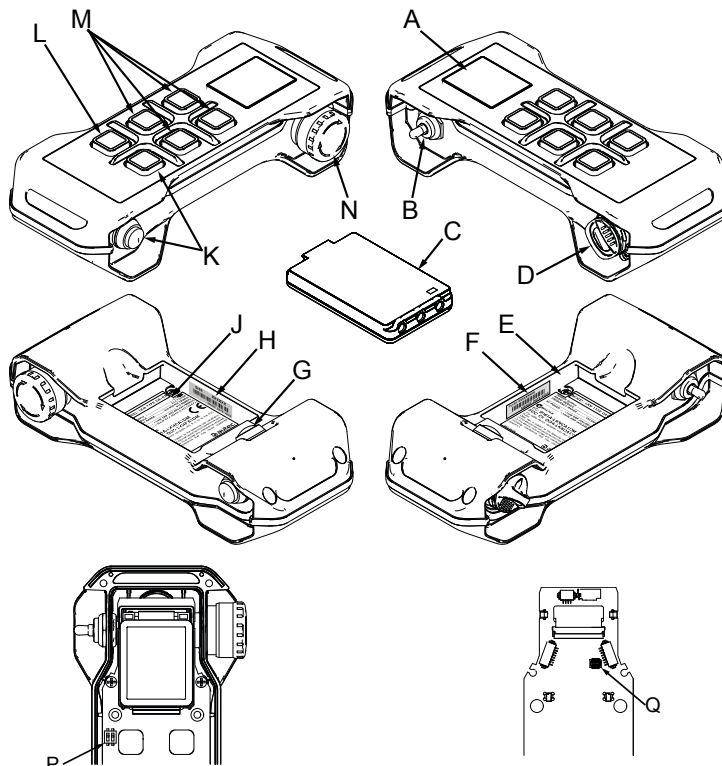

| | |
|---|--|
| A | Display |
| B | Actuator (selector, pushbutton) (if present) |
| C | Battery |
| D | Power keyswitch (if present) |
| E | Battery housing |
| F | Transmitting Unit identification plate |
| G | DISPLAY pushbutton |

| | |
|---|---|
| H | Radio Remote Control identification plate |
| J | Technical data plate |
| K | START pushbutton |
| L | FUNCTION pushbutton |
| M | Command pushbuttons |
| N | STOP pushbutton |
| P | DIP switches |
| Q | Connector for "ID internal tx memory" |

4 Technical data

4.1 Technical data of LK NEO 6 and LK NEO 8 transmitting units (Model LKN Type LA1CM)

| | |
|------------------------------------|----------------------------------|
| Power supply (battery MHM03) | 3.6V== |
| Power supply (battery LPM01) | 3.7V== |
| Antenna | internal |
| Housing material | PA 6 (20%fg) |
| Protection degree | IP65 (NEMA 4) |
| Dimensions | 207,5x85x49mm (8.17x3.35x1.92In) |
| Weight | 380g (0.837Lb) |
| Run time at 20°C (68°F): | |
| - with battery MHM03 | >8h |
| - with battery LPM01 | >16h |

4.2 Technical data of LK NEO 6 DF transmitting unit (Model LKN Type DA1DM)

| | |
|------------------------------------|----------------------------------|
| Power supply (battery LPM01) | 3.7V== |
| Antenna | internal |
| Housing material | PA 6 (20%fg) |
| Protection degree | IP65 (NEMA 4) |
| Dimensions | 207,5x85x49mm (8.17x3.35x1.92In) |
| Weight | 380g (0.837Lb) |
| Run time at 20°C (68°F) | >10h |

5 Technical Data Sheet

The Radio Remote Control 's Technical Data Sheet:

- describes the Transmitting Unit's configuration,
- indicates the relation between commands sent by the Transmitting Unit and those available on the Receiving Unit.

The Technical Data Sheet must be filled in, checked and signed by the Installer, who is responsible for correct wiring.

A Technical Data Sheet must always be kept together with this Manual: if you need to use the Technical Data Sheet for administrative purposes (tests, check, etc.), make a copy of it.

| | |
|---|--|
|  | <p>The wiring of the Receiving Unit's outputs must always reflect the wiring indicated in the Technical Data Sheet.</p> |
|---|--|

6 Plates

The following instructions refer to the plates on different types of Radio Remote Controls where the LK NEO 6, LK NEO 8 and LK NEO 6 DF (Model LKN Type LA1CM, DA1DM) Transmitting Unit may be used.

6.1 Plates on the LK NEO 6, LK NEO 8 and LK NEO 6 DF (Model LKN Type LA1CM, DA1DM) Transmitting Unit in a Radio Remote Control

| Plate | Position | Content |
|--|---|--|
| Radio Remote Control identification plate | Key ID 0-1 (if present) | Radio Remote Control serial number (S/N) |
| | Battery housing (if the "ID internal tx memory" is present) | |
| Transmitting Unit identification plate | Battery housing | Manufacturing year, bar code and Transmitting Unit identification number (TU ID) |
| Technical data plate | Battery housing | MODEL, TYPE and main Transmitting Unit technical data, marking and possible Radio Remote Control marks |

6.2 Plates on the LK NEO 6, LK NEO 8 and LK NEO 6 DF (Model LKN Type LA1CM, DA1DM) Transmitting Unit in a "Take & Release" Radio Remote Control

| Plate | Position | Content |
|--|---|--|
| Radio Remote Control identification plate | Key ID 0-1 (if present) | Radio Remote Control serial number (S/N) |
| | Battery housing (if the "ID internal tx memory" is present) | |
| Transmitting Unit identification plate | Battery housing | Manufacturing year, bar code and Transmitting Unit identification number (TU ID) |
| Technical data plate | Battery housing | MODEL, TYPE and main Transmitting Unit technical data, marking and possible Radio Remote Control marks |

6.3 Plates on the LK NEO 6, LK NEO 8 and LK NEO 6 DF (Model LKN Type LA1CM, DA1DM) Transmitting Unit in a "Multi Units" or "Multi Receiver" Radio Remote Control

| Plate | Position | Content |
|--|---|--|
| Radio Remote Control identification plate | Key ID 0-1 (if present) | Radio Remote Control serial number (MULTI S/N) |
| | Battery housing (if the "ID internal tx memory" is present) | |
| Transmitting Unit identification plate | Battery housing | Manufacturing year, bar code and Transmitting Unit identification number (TU ID) |
| Technical data plate | Battery housing | MODEL, TYPE and main Transmitting Unit technical data, marking and possible Radio Remote Control marks |

7 Light signals

7.1 Light signals on LK NEO 6 and LK NEO 8 Transmitting Units (Model LKN Type LA1CM)

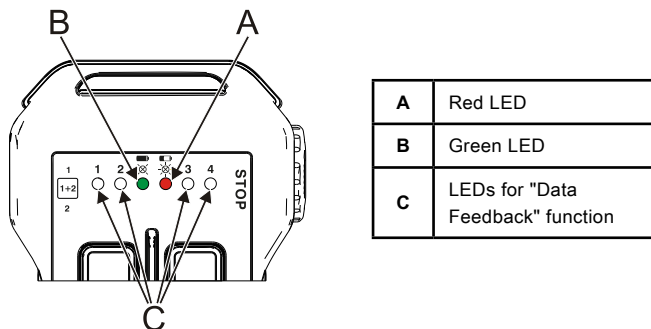

The LK NEO 6 and LK NEO 8 Transmitting Units always have a green LED [B] and a red LED [A] that provide information regarding the Radio Remote Control.

| Symbol | Meaning |
|--------|---|
| | This symbol identifies the red LED [A]. |
| | This symbol identifies the green LED [B]. |

 The meaning of signals provided by the LEDs identified with "C" are explained in the "Data Feedback" function part (see paragraph 8.16). The meaning of LEDs related to the "Data Feedback" function are decided and established by the Machine Manufacturer depending on the Machine's functions for which he wants to receive information.

7.1.1 Red LED [A] and green LED [B]

The meaning of red LED [A] and green LED [B] signals is described in the following tables; possible actions to carry out are given in chapter 11.

 The meaning of the red and green LED signals cannot be modified.

| Signal | Meaning |
|---|---|
| The green LED [B] is off. | The Transmitting Unit is off. |
| The green LED [B] is lit with a steady light. | The Transmitting and Receiving Unit do not communicate. |
| The green LED [B] repeats the sequence: two blinks and a pause. | The working range of the remote control has been exceeded for more than 20 seconds. |
| The green LED [B] repeats the sequence: three blinks and a pause. | The Receiving Unit does not communicate with the transmitting Unit. If the Transmitting Unit communicates with the Receiving Unit, it is possible to send commands. |
| The green LED [B] blinks fast. | The Transmitting and Receiving Unit communicate. It is only possible to send commands after pressing the START pushbutton. |
| The green LED [B] blinks slowly (one blink per second). | It is possible to send commands. |

| Signal | Meaning |
|--|--|
| The red LED [A] is off. | The Transmitting Unit works correctly. |
| The red LED [A] is steady on during start up. | The STOP pushbutton is pressed or damaged. |
| The red LED [A] blinks twice per second during start up. | At least one of the commands that were checked at start-up is enabled or damaged (see Technical Data Sheet). |
| The red LED [A] blinks three times per second during start up. | The battery is flat. |
| The red LED [A] is steady on for two seconds during start up. | The Transmitting Unit does not work correctly. |
| The red LED [A] blinks slowly (one blink per second). | The battery has less than 1h run time. |
| The red LED [A] blinks fast. | The battery has a 10min run time. |

| Signal | Meaning |
|--|--|
| The green [B] and red [A] LEDs are steady on during start up. | A wrong "Key ID 0-1" or "ID internal tx memory" has been inserted in the Transmitting Unit, or this is a "BACK-UP UNIT". |
| The green [B] and red [A] LEDs blink 3 times per second during start up. | The "Key ID 0-1" or the "ID internal tx memory" is damaged. |
| The green LED [B] is lit with a steady light and the red LED [A] blinks two times per second during start up. | The START pushbutton is activated. |
| The green [B] and red [A] LEDs blink alternating. | 30 s left before the Transmitting Unit automatically switches off. |
| The green LED [B] repeats the sequence: 3 blinks and a pause, and the red LED [A] is steady on during start up. | The UNPAIR procedure has been carried out. |

7.2 Light signals on the LK NEO 6 DF Transmitting Unit (Model LKN Type DA1DM)

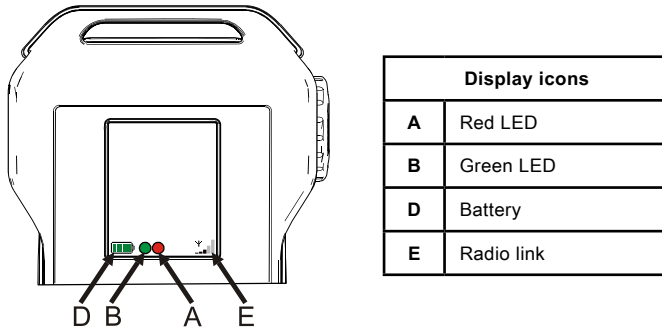

The following icons are always available on the display of LK NEO 6 DF Transmitting Units:

- red LED [A] and green LED [B] providing information about the Radio Remote Control,
- battery [D] providing indication of the battery power level,
- radio link [E] providing indication of radio link strength.

| | |
|---|---|
|  | <p>The meaning of other icons shown on the display is explained in the "Data Feedback" function part (see paragraph 8.16). The meaning of such icons is decided and established by the Manufacturer depending on the Machine's functions for which he wants to receive information.</p> |
|---|---|

7.2.1 Red LED [A] and green LED [B]

The meaning of red LED [A] and green LED [B] signals is described in the following tables; possible actions to carry out are given in chapter 11.

| | |
|---|---|
|  | <p>The meaning of the red and green LED signals cannot be modified.</p> |
|---|---|

| Signal | Meaning |
|---|---|
| The green LED [B] is off. | The Transmitting Unit is off. |
| The green LED [B] is lit with a steady light. | The Transmitting and Receiving Unit do not communicate. |

| Signal | Meaning |
|--|---|
| The green LED [B] repeats the sequence: two blinks and a pause. | The working range of the remote control has been exceeded for more than 20 seconds. |
| The green LED [B] repeats the sequence: three blinks and a pause. | The Receiving Unit does not communicate with the transmitting Unit. If the Transmitting Unit communicates with the Receiving Unit, it is possible to send commands. |
| The green LED [B] blinks fast. | The Transmitting and Receiving Unit communicate. It is only possible to send commands after pressing the START pushbutton. |
| The green LED [B] blinks slowly (one blink per second). | It is possible to send commands. |





| Signal | Meaning |
|---|--|
| The red LED [A] is off. | The Transmitting Unit works correctly. |
| The red LED [A] is steady on during start up. | The STOP pushbutton is pressed or damaged. |
| The red LED [A] blinks twice per second during start up. | At least one of the commands that were checked at start-up is enabled or damaged (see Technical Data Sheet). |
| The red LED [A] blinks three times per second during start up. | The battery is flat. |
| The red LED [A] is steady on for two seconds during start up. | The Transmitting Unit does not work correctly. |
| The red LED [A] blinks slowly (one blink per second). | The battery has less than 1h run time. |
| The red LED [A] blinks fast. | The battery has a 10min run time. |

| Signal | Meaning |
|---|--|
| The green [B] and red [A] LEDs are steady on during start up. | A wrong "Key ID 0-1" or "ID internal tx memory" has been inserted in the Transmitting Unit, or this is a "BACK-UP UNIT". |
| The green [B] and red [A] LEDs blink 3 times per second during start up. | The "Key ID 0-1" or the "ID internal tx memory" is damaged. |

| Signal | Meaning |
|---|--|
| The green LED [B] is lit with a steady light and the red LED [A] blinks two times per second during start up. | The START pushbutton is activated. |
| The green [B] and red [A] LEDs blink alternating. | 30 s left before the Transmitting Unit automatically switches off. |
| The green LED [B] repeats the sequence: 3 blinks and a pause, and the red LED [A] is steady on during start up. | The UNPAIR procedure has been carried out. |



7.2.2 Battery [D]

The Battery icon [D] has a bar, whose length and colour indicate the battery power level.

| Symbol | Meaning |
|--|--|
|  | High power level (green bar). |
|  | Medium power level (green bar). |
|  | Low power level (green bar): the battery has less than 1h run time from the beginning of this signal. |
|  | Very low power level (red bar): the battery has 10min run time from the beginning of this signal. |
|  | The Unit is about to switch off (blinking red bar): the battery has 2min run time from the beginning of this signal. |

7.2.3 Radio link [E]

The Radio link icon [E] consists of five vertical bars. The amount of dark bars is proportional to the quality of radio link.

| Symbol | Meaning |
|---|---------------------------|
|  | Strong radio link signal. |
|  | Medium radio link signal. |
|  | No radio link. |

8 General operating instructions

8.1 Power keyswitch

When the Transmitting Unit has a power keyswitch, this can be:

- A mechanical key (see paragraph 8.1.1)
- A Key ID 0-1 (see paragraph 8.1.2).

The Radio Remote Control cannot work if the power keyswitch is not inserted in the Transmitting Unit.

8.1.1 Mechanical key

The mechanical key makes it possible to power the Transmitting Unit.

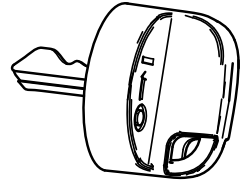

8.1.2 "Key ID 0-1"

The "Key ID 0-1" makes it possible to power the Transmitting Unit. It stores the Radio Remote Control's address. Therefore, the "Key ID 0-1" can only be used in the Transmitting Unit of the Radio Remote Control to which it belongs.

As the Radio Remote Control's address is stored in the "Key ID 0-1", this must be used with very strict care.

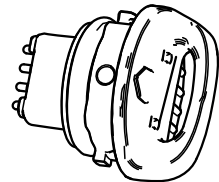

Only use the "Key ID 0-1" for the Transmitting Unit with which it was provided.

8.1.3 power keyswitch insertion

Perform the following operations to insert the power keyswitch:

1. introduce the power keyswitch inside the corresponding housing.
2. rotate the power keyswitch clockwise.

8.1.4 power keyswitch removal

Perform the following operations to remove the power keyswitch:

3. rotate the power keyswitch anticlockwise,
4. pull the power keyswitch to remove it from the corresponding housing.

8.2 START pushbutton

The START pushbutton is used to:

- start the Radio Remote Control (see paragraph 8.11),
- activate the horn when the Radio Remote Control is started.

8.3 STOP pushbutton

When the STOP pushbutton is activated, the Machine stops and the Transmitting Unit switches off. To start the Radio Remote Control again and enable it to control the Machine after the STOP pushbutton has been pressed, you need to:

- make sure that the working and usage conditions are safe,
- pull or turn the STOP pushbutton in the arrow direction (shown on the button) to unlock it,
- start the Radio Remote Control following the procedure described in paragraph 8.11.

| | |
|---|--|
|  | <p>The STOP pushbutton should be pressed when it is necessary to stop the Machine immediately whenever a dangerous condition occurs.</p> <p>The Machine Manufacturer and/or the Installer must provide the User with the instructions and warnings concerning possible risks that may originate from the Machine stop (by way of example: movement inertia, swinging load...).</p> |
|---|--|

8.4 FUNCTION pushbutton

The function of the FUNCTION pushbutton is decided by the Installer of the Radio Remote Control. The Machine Manufacturer and/or the Installer must provide the user with instructions about the relation between the FUNCTION pushbutton and the corresponding movement on the Machine. The User must be properly trained about this.

8.5 DISPLAY pushbutton (if the Transmitting Unit has a display)

The functions of this pushbutton are:

- Activates the display lighting.
- It cyclically scrolls the information on the display in two different modes:
 - Manual: the lines scroll up each time the pushbutton is pressed.
 - Automatic: when the DISPLAY pushbutton is pressed for 3 seconds, the lines scroll automatically. If the DISPLAY pushbutton is pressed again, it switches back to Manual mode.

It is not possible to scroll the lines if icons only are displayed.

The display lighting stays on for a time set by the Machine Manufacturer.

| | |
|---|--|
|  | <p>No function other than the above mentioned functions must be given to the display pushbutton when the Unit is installed.</p> |
|---|--|

8.6 Enabling switch

A three-position actuator, called "Enabling switch", can be present on the left side of the Transmitting Unit.

The "Enabling switch" is an actuator that needs to be activated at the same time as other actuators in order to consent to send the corresponding commands to the Machine. The Manufacturer and/ or the Installer decide which actuators need to have the "Enabling switch" activated to send commands to the Machine.

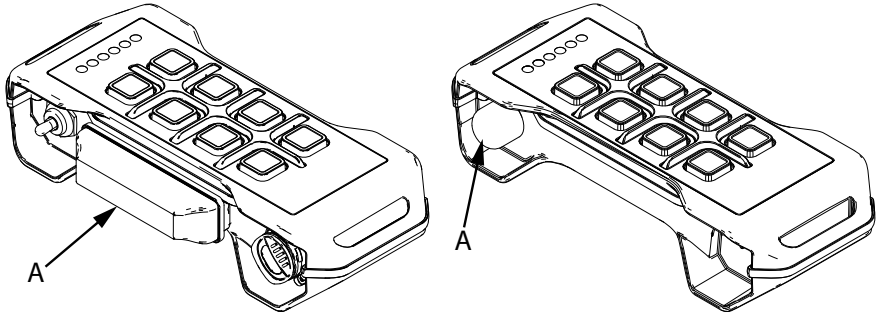

| | |
|---|-----------------|
| A | Enabling switch |
|---|-----------------|

These are the three possible positions for the "Enabling switch":

1. not pressed (OFF),
2. half pressed (ON),
3. completely pressed (OFF).

The "Enabling switch" is only activated when it is in position "2".

When you release the "Enabling switch" from position "3", you will skip position "2" and go directly to position "1".



WARNING

NEVER USE TAPE, ELASTIC BANDS OR OTHER OBJECTS TO INTERFERE WITH THE OPERATION OF THE "ENABLING SWITCH". DOING SO COULD DAMAGE THE UNIT, PREVENTS THE PROPER FUNCTIONING OF THE UNIT AND COULD CAUSE SERIOUS INJURY OR DEATH, AND/OR PROPERTY DAMAGE.



WARNING

The "Enabling switch" can only be associated to the enabling function to activate other commands, and cannot be connected to any other start up or movement function of the Machine.

8.7 Battery

| | |
|---|--|
|  WARNING | <p>The Air series' Transmitting Units can only be powered by Autec rechargeable batteries.</p> <p>For any warnings and instructions regarding the battery, see "Part E" in the Instruction Manual.</p> |
|---|--|

8.7.1 Battery insertion

Push the battery towards the contacts on the Transmitting Unit (1) and insert it inside the housing (2).

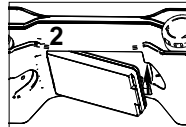
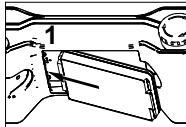

| | |
|---|---|
|  | <p>The battery slides easily into place and ensures that the positive (+) and negative (-) poles are correctly connected only if it is inserted with the plate facing its housing, so that the battery's contacts match the Transmitting Unit's contacts.</p> |
|---|---|

8.7.2 Battery removal

Push the battery towards the contacts on the Transmitting Unit (3) and remove it from the housing (4).

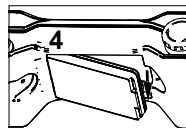
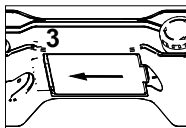

When the Transmitting Unit is not in use, remove the battery if possible.

8.7.3 Indication of the battery charge level in the LK NEO 6 DF Transmitting Unit (Model LKN Type DA1DM)

See paragraph 7.2.2 to check the battery charge level in the LK NEO 6 DF Transmitting Unit.

8.7.4 Indication of the battery charge level in the LK NEO 6 and LK NEO 8 Transmitting Unit (Model LKN Type LA1CM)

Perform the following procedure to check the charge level of the battery in the LK NEO 6 and LK NEO 8 Transmitting Units:

1. switch off the Transmitting Unit and unlock the STOP pushbutton,
2. activate command S1 (check in the Technical Data Sheet which actuator it corresponds to) and press the START pushbutton until LED 1, LED 2 and LED 3 (indicating battery level) illuminate:
 - 1 LED on: low level
 - 2 LEDs on: medium level.
 - 3 LEDs on: maximum level.

The charge level indication disappears after some seconds.



Commands associated to the actuators that are activated during the procedure to check the battery charge level are not sent to the Machine.

8.8 ID internal tx memory

The "ID internal tx memory" is a key containing the address that is used to code messages exchanged between the Transmitting Unit and the Receiving Unit.

This key, if present, is inside the Transmitting Unit.

LK NEO 6 and LK NEO 8 (Model LKN Type LA1CM)

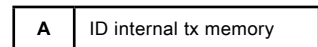
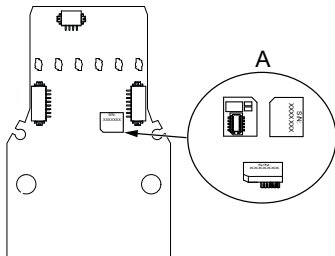

LK NEO 6 DF (Model LKN Type DA1DM)

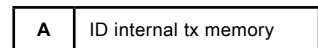
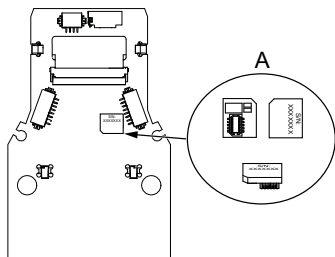

When the Transmitting Unit does not have the "Key ID 0-1" (see paragraph 8.1.2), the Technical Data Sheet shows if an "ID internal tx memory" is present (DIP switch 2 is set in the ON position).

8.9 Zero-G sensor



The Transmitting Unit is equipped with a Zero-G sensor only upon request of the Machine Manufacturer and/or of the Installer, who are responsible for the decision on the conditions for the Zero-G sensor to activate.

The Zero-G sensor can activate for one or more of the following causes:

- **Impact:** the Zero-G sensor activates when the Transmitting Unit impacts with at least a 30-centimetre movement and with an acceleration higher than 2g.
- **Fall:** the Zero-G sensor activates when the Transmitting Unit falls from higher than 1 meter.
- **Tilt:** the Zero-G sensor activates when the Transmitting Unit is tilted for more than one second by a defined angle with respect to the ground. The value of the tilting angle is set by Autec, but it is decided by the Machine Manufacturer and/or by the Installer (possible options: 45°/60°/90°).

The Zero-G sensor may also activate if the Transmitting Unit is thrown or is rolling. In this case the Zero-G sensor activates due to the first detected event among the above-mentioned ones (impact, fall, tilt).

Autec sets the system so that when the Zero-G sensor activates, one of the following behavior occur:

- the Transmitting Unit switches off,
- all the Radio Remote Control's commands are deactivated, except one particular Machine function, which is activated at the same time (e.g. horn).



The Machine Manufacturer and/or the Installer have the responsibility to decide the behaviour of the Zero-G sensor. Before using the Machine, the User must be aware of the expected behaviour and make sure that it works correctly.

8.10 Vibration alarm

The LK NEO 6 DF Transmitting Unit (Model LKN Type DA1DM) can be equipped with the "Vibration alarm".

The "Vibration alarm" activates the Transmitting Unit's vibration if specific signals coming from the Machine are shown on the display.

The Transmitting Unit's vibration aims at drawing the User's attention to the corresponding signal shown on the display.

The Transmitting Unit can be equipped with the "Vibration alarm" upon request of the Machine Manufacturer and/or the Installer.



The Machine Manufacturer and/or the Installer decide which signals shown in the display must cause the vibration of the Transmitting Unit.

8.11 Starting up the Radio Remote Control

Starting up the Radio Remote Control consists in establishing a radio link between the Transmitting Unit and the Receiving Unit.

| | |
|--|---|
|  WARNING | <p>The Radio Remote Control start up is protected by means of a power keyswitch and/or a PIN code to prevent unauthorised use of the Machine.</p> <p>To start up the Radio Remote Control, you need to insert the power keyswitch and/or to key in the PIN code according to the procedure provided in paragraph 8.11.1,8.11.2 or 8.11.3.</p> |
|--|---|

The PIN code is not a sequence of numbers, but it consists in the sequential activation of actuators.

| | |
|---|--|
|  | <p>Commands associated to the actuators that are activated while inserting the PIN code are not sent to the Machine.</p> |
|---|--|

If the Transmitting Unit does not have a power keyswitch, the Radio Remote Control start up is protected by PIN code.

On the contrary, when the Transmitting Unit needs a power keyswitch, Radio Remote Control start up is protected by the power keyswitch itself. If the risk assessment requires further protection of the Radio Remote Control start up, the PIN code can be activated too.

8.11.1 Power keyswitch start up (no PIN code)

When the Receiving Unit is powered on correctly, perform the following procedure:

1. Insert a charged battery in the Transmitting Unit (see paragraph 8.7.1),
2. insert the power keyswitch in the Transmitting Unit (see paragraph 8.1.3),
3. press the START pushbutton and hold it down until the green LED blinks quickly.
4. release the START pushbutton.

When the green LED blinks slowly, the Radio Remote Control is active and it can send commands and activate the Machine.

8.11.2 PIN code start up (no power keyswitch)

When the Receiving Unit is correctly powered on, perform the following procedure; press each pushbutton within 3 seconds after releasing the previous one:

1. Insert a charged battery in the Transmitting Unit (see paragraph 8.7.1),
2. press the START pushbutton and hold it down until the green LED illuminates,
3. activate the commands corresponding to PIN code in the correct sequence (PIN 1, PIN 2 and PIN 3 given in the Technical Data Sheet).
 - a. PIN 1 shall not be included in the start up procedure if it coincides with the START pushbutton.
 - b. PIN 3 shall not be included in the start up procedure if it coincides with the START pushbutton.
4. press the START pushbutton and hold it down until the green LED blinks quickly.
5. release the START pushbutton.

When the green LED blinks slowly, the Radio Remote Control is active and it can send commands and activate the Machine.

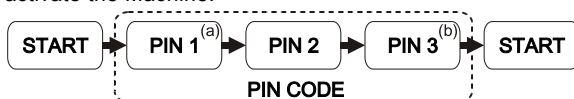

Note: default PIN code set by AUTEK is:

- PIN 1=START pushbutton.
- PIN 2=FUNCTION pushbutton.
- PIN 3=START pushbutton.

| | |
|---|---|
|  | <p>Autek will set a customized PIN code only upon request by the Machine Manufacturer or the Installer.</p> |
|---|---|

8.11.3 Power keyswitch + PIN code start up

When the Receiving Unit is correctly powered on, perform the following procedure; press each pushbutton within 3 seconds after releasing the previous one:

1. Insert a charged battery in the Transmitting Unit (see paragraph 8.7.1),
2. insert the power keyswitch in the Transmitting Unit (see paragraph 8.1.3),
3. press the START pushbutton and hold it down until the green LED illuminates,
4. activate the commands corresponding to PIN code in the correct sequence (PIN 1, PIN 2 and PIN 3 given in the Technical Data Sheet).
 - a. PIN 1 shall not be included in the start up procedure if it coincides with the START pushbutton.
 - b. PIN 3 shall not be included in the start up procedure if it coincides with the START pushbutton.
5. press the START pushbutton and hold it down until the green LED blinks quickly.
6. release the START pushbutton.

When the green LED blinks slowly, the Radio Remote Control is active and it can send commands and activate the Machine.

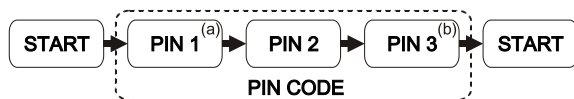

8.11.4 Procedure to modify the PIN code

If a PIN code is needed for the Transmitting Unit, it can be modified to limit the use of the Radio Remote Control.

To modify the PIN code, perform the following procedure with the Transmitting Unit switched off and the STOP pushbutton released.

1. Press pushbuttons FUNCTION and START and hold them down until the green LED blinks (1 blink per second).
2. Activate the commands of the PIN code sequence provided in the Technical Data Sheet.
3. Activate command S1 (see Technical Data Sheet) repeatedly until LED 2 illuminates.
4. Activate command S2 (see Technical Data Sheet) to confirm your selection (green LED blinks twice per second). You can choose the 3 commands you want to set as PIN code amongst all the commands on the Unit. If you want to start the Radio Remote Control with:
 - a single-command PIN code: press the START pushbutton as PIN 1 and PIN 3;
 - two-command PIN code: press the START pushbutton as PIN 1 or PIN 3.
5. Activate the command you want to allocate as PIN 1 (LED 1 and green LED are steady on).
6. Activate the command you want to allocate as PIN 2 (LED 2 and green LED are steady on).
7. Activate the command you want to allocate as PIN 3 (LED 3 and green LED are steady on). PIN code is saved automatically.

8.12 Command activation

When the Radio Remote Control is started, it is possible to activate movements, functions and commands on the Machine by acting on the related pushbuttons or switches, whose functions and symbols are decided by the Manufacturer and/or the Installer. To identify the relation between the actuators and the corresponding Machine movements, the Machine Manufacturer and/or the Installer shall provide relevant instructions and the User shall be properly trained.

8.13 Radio link interruption

When the radio link is incorrect or interrupted, the automatic stop function activates (see paragraph "Control devices" in the Instruction Manual's general part).

The green LED of the Transmitting Unit signals this interruption by switching from slow blinking to one of the following statuses (see chapter 11):

- fast blink;
- on with steady light;
- two blinks and a pause;
- three blinks and a pause.

8.14 Transmitting Unit automatic switch off

The Transmitting Unit automatically switches off when:

- the battery is flat (see paragraph 8.14.1),
- the Radio Remote Control is not used for a certain time (see paragraph 8.14.2).

To start the Radio Remote Control, see paragraph 8.11.

8.14.1 Low battery

The Transmitting Unit indicates if the battery is not sufficiently charged.

- the red LED blinks slowly (one blink per second): the battery has less than 1h run time.
- The red LED blinks fast: the battery has a 10 minute run time from the first signal, after which the Transmitting Unit automatically switches off.

It is necessary to bring the Machine to a safe state and replace the battery with a charged one (see paragraph 8.7).

8.14.2 When the Transmitting Unit is not used

If the Transmitting Unit remains started with no enabled commands, it will automatically switch off after a predetermined time frame. This time frame is specified in the Technical Data Sheet (SWITCH-OFF).

Before the Transmitting Unit switches off automatically, the green and red LEDs blink alternating for 30 seconds.

Activating any actuator corresponding to a movement command reduces the predetermined automatic switch-off time (SWITCH-OFF) to zero.



Setting or removal of the automatic switch off time (SWITCH-OFF) is done by Autec and decided by the Machine Manufacturer or by the Installer, depending on the operation and functions they need on the Machine.

8.15 Switching off the Transmitting Unit



Switch off the Transmitting Unit when not actively using the Radio Remote Control to operate the Machine, or when work is otherwise interrupted, even for short periods. Do not leave the load hanging or the Machine in dangerous conditions (even when charging the Unit or changing the battery).

FAILURE TO DO SO CAN RESULT IN SERIOUS BODILY INJURY OR DEATH AND/OR PROPERTY DAMAGE.

Voluntary switch off of the Transmitting Unit occurs in the following cases:

- when the power keyswitch (if present) is turned anti-clockwise or removed;
- when battery is removed (see paragraph 8.7.2);
- when the STOP pushbutton is pressed.

8.16 "Data Feedback" function

The "Data Feedback" function acts through the LED array or the display. The User receives information and/or signals concerning some particular situations and the movements of the controlled Machine by means of this function.

During normal Radio Remote Control operation, pay particular attention to the indications displayed and signalled by the display or through the LEDs: they can be helpful to evaluate the Machine working status.

| | |
|--|--|
|  WARNING | <p>Any information shown and signalled on the display and/or through the "Data Feedback" LEDs can never be considered or used as a safety signal or for legal metrology.</p> <p>When operating and moving the Machine, remember that the Radio Remote Control does not operate autonomously when potential hazardous situations are displayed and signalled.</p> |
|--|--|

| | |
|---|---|
|  | <p>If the green LED repeats the sequence "three blinks and a pause", there is no information and/or signals coming from the "Data Feedback" function. In this case, bring the Transmitting Unit closer to the Receiving Unit until the green LED blinks slowly.</p> |
|---|---|

8.16.1 Operation with display

If the Transmitting Unit has a display, it is possible to show warning icons, the measurements collected from the Machine and their description.

The Machine Manufacturer chooses which information are displayed and the way they are displayed (icons and/or measurements and/or descriptions).

8.16.2 Operation with LED

If the Transmitting Unit has an LED array for the "Data Feedback" function, specific Machine conditions are signalled if they are illuminated (by way of example: load limits, limit switch). The signalled conditions depend on the settings chosen by the Machine Manufacturer.

8.17 BACK-UP UNIT

If the Transmitting Unit cannot be used, it can be replaced with a Transmitting Unit called "BACK-UP UNIT"; you need to ask for it from Autec.

It is identical to the Unit that can no longer be used; the only difference is the presence of the plate "BACK-UP UNIT" on the battery housing.



Set DIP switch 2 in the "BACK-UP UNIT" as shown in the Technical Data Sheet.

If no "Key ID 0-1" or "ID internal tx memory" is present in the Transmitting Unit that can no longer be used, perform the PAIR procedure to pair the "BACK-UP UNIT" with a Receiving Unit (the Technical Data Sheet shows which PAIR procedure to use).

If a "Key ID 0-1" or an "ID internal tx memory" is present in the Transmitting Unit that can no longer be used, move it to the "BACK-UP UNIT" and perform the address saving procedure described below.



As required by standard IEC 60204-32, each Radio Remote Control is uniquely identified through a serial number. Therefore, upon replacement of the Unit, the serial number of the Transmitting Unit to be replaced must be marked on the "BACK-UP UNIT", so that all Units belonging to the Radio Remote Control will show the same serial number.

Autec cannot be held responsible if the serial number of the Transmitting Unit to be replaced has not been marked on the "BACK-UP UNIT".

Address storage

With fully charged battery and power keyswitch in the "BACK-UP UNIT", perform this procedure:

1. press the START pushbutton and hold it down until the green and red LEDs light up,
2. wait until the green LED blinks slowly,
3. within 3 seconds, activate in sequence the commands corresponding to PIN 1, PIN 2 and PIN 3 that compose the PIN code given in the Technical Data Sheet.

If the PIN code is incorrect, the red LED illuminates and the Transmitting Unit switches off. In this case, the storage procedure shall be repeated.

If the PIN code is correct, the green LED turns steady on and the Transmitting Unit switches off: this indicates that the address has been stored in the "BACK-UP UNIT". It is now possible to start the Radio Remote Control and control the Machine with the "BACK-UP UNIT" Transmitting Unit.

9 Instructions for the User

The chapter "Instructions for the User" in "Part A" of the Instruction Manual contains the warnings for the use that add to those provided in this chapter. Therefore, please refer to that part of the Manual.

The following instructions refer to general usage situations for the LK NEO 6, LK NEO 8 and LK NEO 6 DF (Model LKN Type LA1CM, DA1DM) Transmitting Unit, and indicate how user should or should not behave when using the Unit: these do not cover any possible risk situation and/or drawback that may depend on specific applications of Autec Radio Remote Controls. However, instructions given in the following paragraphs do not replace nor complete the instructions that must be provided to the User by the Manufacturer of the Machine where an Autec Radio Remote Control (to which the LK NEO 6, LK NEO 8 and LK NEO 6 DF (Model LKN Type LA1CM, DA1DM) Transmitting Unit belongs) is installed.

9.1 Usage restrictions

| | |
|--|---|
|  WARNING | <p>If the Radio Remote Control User wears electronic devices (by way of example: pacemaker, implantable cardiac defibrillator, hearing aids), the Transmitting Unit must be kept at least 15 cm away from those devices when in use.</p> |
|--|---|

9.2 User behaviour

Besides the instructions contained in the General Part (Part A) of the Instruction Manual, when using the LK NEO 6, LK NEO 8 and LK NEO 6 DF (Model LKN Type LA1CM, DA1DM) Transmitting Unit, the User must:

- observe and comply with all instructions and warnings provided by the Machine Manufacturer;
- observe and comply with all instructions and warnings provided by the Installer;
- observe and comply with all instructions and warnings provided by the Person responsible for the Machine commissioning or making the Machine available for work;
- observe and comply with all instructions and warnings provided in the Radio Remote Control Manual;
- observe and comply with all applicable Laws, Regulations and Standards, even local.
- follow and put into practice the working instructions he received, and/or those he must be aware of because of his work and his tasks;
- avoid using the Radio Remote Control if he has not been properly trained and prepared, and if he has not been qualified for its use by the Person responsible for the work;
- make sure that the Transmitting Unit and the Receiving Unit are whole and work perfectly;
- make sure that the Machine reacts correctly to the commands activated by the Autec Radio Remote Control;

- not perform any operation if the tests mentioned in the previous two points did not give positive results;
- make sure that the Radio Remote Control operation and the consequent Machine movement occur in safety conditions, to prevent hazards to people and/or property;
- adopt the necessary caution to avoid that the Machine operation causes dangerous situations of any type; to this end, the User's physical and health status shall be taken into account too;
- avoid leaving the Transmitting Unit unattended or in such a condition that it may be damaged, tampered with, operated by people who are not qualified or by the movement of people and/or objects (by way of example due to: fall, movement, contact);
- operate the Transmitting Unit by holding it correctly in his hands, so that he can activate the Machine movements correctly and in safe conditions and monitor its light signals;
- keep at a safe distance from any risk situations originating from the use of the Machine where the Autec Radio Remote Control is installed;
- avoid doing anything else while using the Radio Remote Control, such as, by way of example, operate other Machines and/or other devices, eat and/or drink, use communication devices (phone, radio phone, etc.), keyboards, computers, IT devices or AV equipment, or carry out any other action that may pose the User in the situation not to be able to correctly control the Transmitting Unit and/or the Machine;
- activate immediately, and anyway in safe conditions, the stop devices available on the Transmitting Unit and/or on the Machine, in case dangerous situations occur, even if they do not depend on the use of the Machine;
- use the Transmitting Unit in such a way as to avoid contact with objects and/or people, fall and loss of control;
- use the Transmitting Unit with supports such as belts and the like, which are provided with the Radio Remote Control;
- not modify or tamper with the Transmitting Unit, its components and/or its commands; not modify the indications and/or meaning and/or abbreviations and/or symbols and/or original stickers on the Transmitting Unit's panel.

9.3 Belt and pouch with belt

The LK NEO 6, LK NEO 8 and LK NEO 6 DF (Model LKN Type LA1CM, DA1DM) Transmitting Unit always comes with a belt or a pouch with belt: the User must mount and use the belt and the pouch with belt as explained in the paragraphs 9.3.1 and 9.3.2.

9.3.1 Belt or harness

Assembly

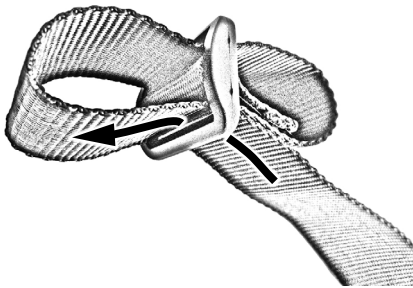

1

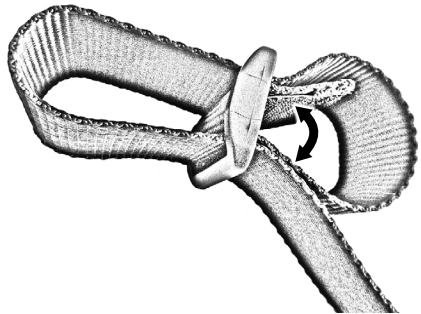

2

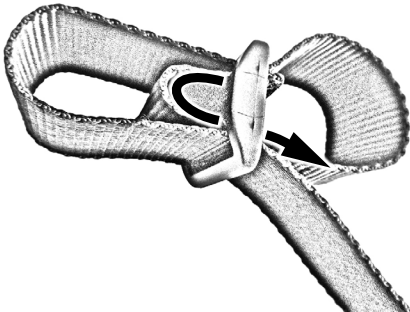

3

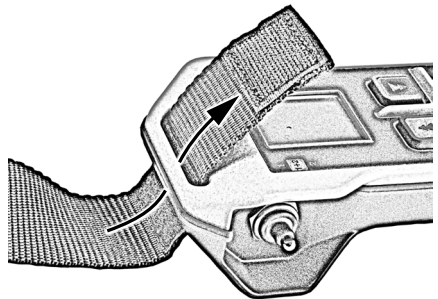

4

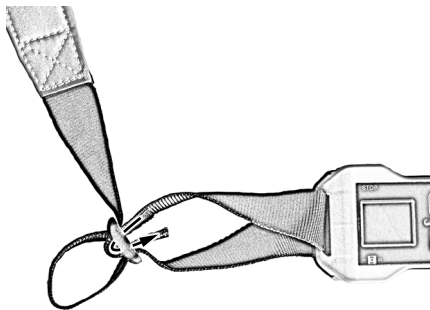

5

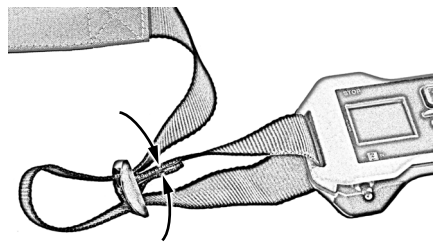

6

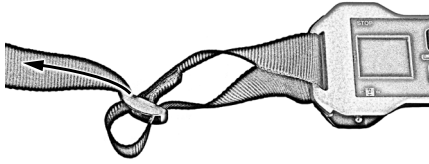

7

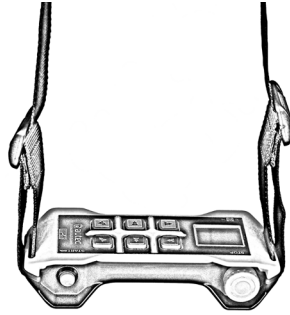

8

Use

The User must wear the Radio Remote Control with the belt as shown in the photo below, to avoid its fall, loss, loss of control, accidental contact and improper use.



If the Transmitting Unit and the belt are used in a different way from the one described in the above mentioned figure, this constitutes improper use and may lead to damage to the Transmitting Unit, to the User, to people and/or property.



Replace the belt or harness if it is damaged or worn.

**9.3.2 Pouch with belt
Assembly**

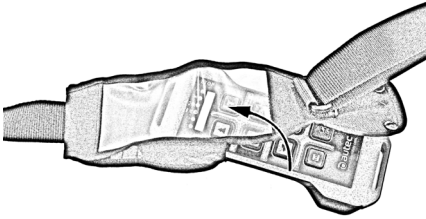

1

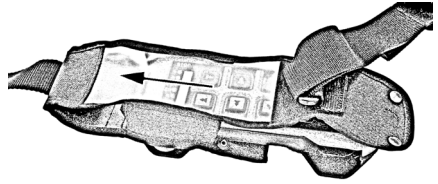

2

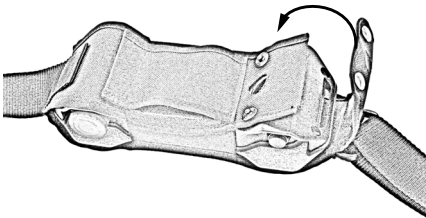

3

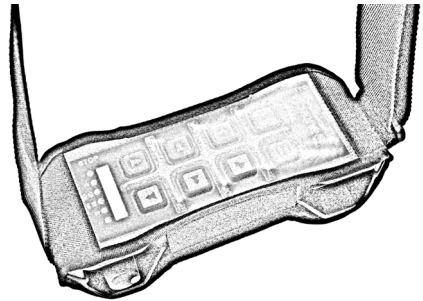

4

Use

The User must wear the Radio Remote Control with the pouch with belt as shown in the photo below, to avoid its fall, loss, loss of control, accidental contact and improper use.



If the Transmitting Unit and the pouch with belt are used in a different way from the one described in the above mentioned figure, this constitutes improper use and may lead to damage to the Transmitting Unit, to the User, to people and/or property.



Replace the pouch with belt if it is damaged or worn.

10 Maintenance

Instructions for correct Radio Remote Control maintenance are described in the chapter "Maintenance" included in "Part A" of the Instruction Manual. Therefore, please refer to that part of the Manual.

11 Malfunction signalled by the Transmitting Unit

The table below lists malfunctions that are signalled by LEDs on the Transmitting Unit and the solution to those malfunctions.

If the problem persists after attempting the suggested solution, contact the support service of the Machine Manufacturer.

| Signals | Possible reason | Solutions |
|---|--|---|
| The green LED is lit with a steady light or it repeats the sequence: three blinks and a pause. | The Transmitting and Receiving Unit do not communicate. | Bring the Transmitting Unit closer to the Receiving Unit until the green LED blinks quickly (if the signal doesn't change, check that the Receiving Unit is powered), then press and release the START pushbutton. When the START pushbutton is released, the green LED starts blinking slowly (it is possible to send commands). |
| The green LED repeats the sequence: two blinks and a pause. | The working range of the Radio Remote Control (see paragraph "Technical data" in the general part of the Instruction Manual) has been exceeded for more than 20 seconds. | Bring the Transmitting Unit close to the Receiving Unit, then press and release the START pushbutton. When the START pushbutton is released, the green LED starts blinking slowly (it is possible to send commands). |
| The green LED blinks fast. | Temporary loss of radio link. | Bring the actuators related to movement commands to the rest position, then press and release the START pushbutton. When the START pushbutton is released, the green LED starts blinking slowly (it is possible to send commands). |
| The green LED blinks slowly (one blink per second). | The Receiving Unit may not work correctly. | See "Malfunctions signalled by the Receiving Unit " in "Part D" of the Manual. |
| The red LED is steady on during start up | The STOP pushbutton is pressed or damaged. | Unlock the STOP pushbutton. |

| Signals | Possible reason | Solutions |
|--|--|--|
| The red LED blinks twice per second during start up. | At least one of the commands that were checked at start-up is enabled or damaged (see Technical Data Sheet). | Move the actuators related to the commands monitored during the start up to the rest position. |
| The red LED blinks three times per second during start up. | The battery is flat. | Replace the battery with a charged one. |
| The red LED is steady on for two seconds during start up. | The Transmitting Unit does not work correctly. | Contact the support service of the Machine Manufacturer. |
| The green and red LEDs are steady on during start up. | A wrong "Key ID 0-1" or "ID internal tx memory" has been inserted in the Transmitting Unit. | Use the correct "Key ID 0-1" or "ID internal tx memory". |
| | You are using a "BACK-UP UNIT" with the "Key ID 0-1" or "ID internal tx memory" of the Transmitting Unit that has been replaced. | Store the address in the "BACK-UP UNIT" (see paragraph 8.17). |
| The green and red LEDs blink three times per second during start up. | The "Key ID 0-1" or the "ID internal tx memory" is damaged. | Contact the support service of the Machine Manufacturer. |
| The green LED is lit with a steady light and the red LED blinks two times per second during start up. | The START pushbutton is activated. | Release the START pushbutton. |
| The green LED repeats the sequence: 3 blinks and a pause, and the red LED is steady on during start up. | The UNPAIR procedure provided in the document "Menu of Transmitting Unit (MTU)" has been carried out. | Perform the ALIGNMENT procedure. |

12 Decommissioning and disposal

Instructions for correct decommissioning and disposal of Radio Remote Controls are described in chapter "Decommissioning and disposal" in "Part A" of the Instruction Manual. Therefore, please refer to that part of the Manual.



Via Pomaroli, 65 - 36030 Caldogno (VI), ITALY
PH: +39 0444 901000 - Fax: +39 0444 901011
info@autecsafety.com - www.autecsafety.com

MADE IN ITALY