

Air series

User manual

Description, warnings and instructions

Warnings and caption for the documentation attached to the radio remote control

The attached documentation is an integral part of the radio remote control and it aims at providing the instructions needed for using and maintaining the system, paying particular attention to the safety functions. Always remember that:

- photos and drawings are useful examples that help understand the instructions and warnings of each radio remote control configuration
- if necessary, contact Autec if any of the instructions and/or warnings are not clear.

No part of the documentation may be reproduced, in any form or by any means, without written permission of Autec (including recording and photocopying).

If documentation is lost or damaged, ask Autec for a copy. Please specify the serial number of the related radio remote control.

The documentation must be kept for the whole life of the radio remote control: after reading it, keep it on hand for future reference.

All installation, usage and maintenance operations must be carried out by qualified technicians who are suitably trained with respect to the relevant norms and laws.



Information contained in the radio remote control documentation adds to and completes the information provided by the manufacturer of the remote controlled machine and/or by those who install the radio remote control on the machine.

Therefore, this documentation must be read and understood in all its parts by the user and by:

- the radio remote control owner and/or installer
- the person responsible for and in charge of maintenance and/or safety in the workplace where the radio remote control is used.

As for instructions and warnings regarding the machine where the radio remote control is installed, follow the instructions given in the machine's manual.

Three symbols are employed throughout documentation, which are used to highlight specific safety-related issues. They are classified according to the hazardous situation that may arise and on the possible consequences:

Symbol	If the highlighted instructions are not respected ...		
	... a dangerous situation will occur...	...consequences for people may be...	...consequences for property may be...
 DANGER	...highly probable.	... critical (death or physical damage).	... critical.
 WARNING	... probable.	... critical (death or physical damage).	... critical.
 CAUTION	... probable.	... moderate (non-severe physical damage).	... moderate.

	This symbol is also used, and it identifies texts to be read carefully.
---	---

AIR SERIES

Part A: Description, warnings and instructions

INDEX

1	Radio remote control description	6
1.1	How the radio remote control works	6
1.2	Technical Data	6
1.3	Applications	6
1.4	Radio link	7
1.5	Classification of commands	7
1.6	Safety function: stop protection	7
1.7	Protection against unintended movements from the rest position	8
1.8	Identifying the radio remote control	8
2	Risk assessment	9
2.1	Risk assessment for radio remote controlled machines	9
2.2	Staff training	10
2.3	Working conditions	10
3	Warnings for installation	11
3.1	General	11
3.2	Mounting and fastening the receiving unit in the best position	11
3.3	Positioning the antenna	12
3.4	Wiring	14
3.5	At end of installation	16
3.6	Testing	16
4	Warnings for use	17
4.1	Before starting to work	17
4.2	During normal operation	18
4.3	After using the radio remote control	18
5	Radio remote control life cycle	19
5.1	Transportation and storage	19
5.2	Installation	19
5.3	Use	20
5.4	Radio remote control maintenance	20
5.5	Machine maintenance	25
5.6	Disposal	25
6	Troubleshooting	26
6.1	Radio remote controls with Data Feedback function	26
6.2	Radio remote controls with wire control	26
6.3	Solutions in case of malfunction	26

1 Radio remote control description

1.1 How the radio remote control works

Industrial radio remote controls are used to control machines from a distance, without physical connection between the user and the machine (i.e. wires or connecting cables). They consist of a portable transmitting unit, from which the user remotely controls the machine, and a receiving unit installed on board the machine itself.

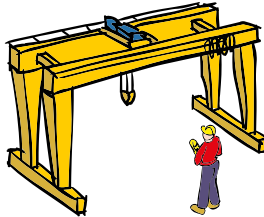

1.2 Technical Data

Command response time (typical)	140ms
Working range (typical)	75-100m (240-330ft)
Stop time (typical)	100ms
Max. stop time	0.5s
Performance Level of the "stop protection" in compliance with ISO 13849-1	PL d

1.3 Applications

AIR series' radio remote controls can be installed on hoisting and material handling machines (i.e. overhead cranes).

 <p>DANGER</p>	<p>AIR series radio remote controls cannot be installed:</p> <ul style="list-style-type: none"> - on machines working in zones with risk of explosion - on machines for people lifting and transportation (the machine's manufacturer may authorize installation and use of a radio remote control on such applications under their own responsibility, if the risk assessment they carried out gave positive results) - on machines that may generate dangerous situations if they stop due to the loss of radio link - on machines for which a risk assessment is not possible or gave negative results
--	--

Autec cannot be held responsible if the radio remote control is installed on forbidden applications.

1.4 Radio link

The transmitting unit constantly communicates with the receiving unit through a radio link. This is an essential requirement to ensure safety for the radio remote controlled machine. The two units use messages coded through an address that is unique (produced by Autec only once) and univocal (specific for each radio remote control). Each unit can only decode messages coming from the unit with the same address. This prevents messages from other radio equipment from activating any "machine+radio remote control" system function.

1.5 Classification of commands

Commands sent by the transmitting unit are classified according to their type.

1.5.1 Type of command: analogue or digital

Commands sent by the transmitting unit can either be analogue or digital.

Analogue commands generate proportional outputs as a function of the position of the corresponding actuator.

Digital commands switch the status of their corresponding output, according to the position of the related actuator. This status can either be on or off.

1.5.2 Name of commands

All commands sent by the transmitting unit are identified by abbreviations, which are written in the technical data sheet to highlight the match between commands sent and machine functions.

1.6 Safety function: stop protection

The stop function brings the machine to a safe state every time it is necessary to stop it due to a potentially hazardous situation. Depending on the situation, this function can either be deliberately activated by the operator through the STOP pushbutton, or it is automatically activated when the radio link is incorrect or interrupted (the receiving unit autonomously stops the radio remote control).

The stop function by means of radio remote control is available only if the radio remote control is started up (see "Starting up the radio remote control" in the "Part C" of the manual). In any other condition the transmitting unit is not able to bring the machine in a safe state.



Never leave the transmitting unit unguarded in order to avoid uncertainty about the availability or unavailability of the stop function.

The life time of the stop function is 20 years. In any case, the radio remote control must be replaced within this period.

1.7 Protection against unintended movements from the rest position

This function protects the system "machine+radio remote control" from unintended movements, namely machine movements not activated intentionally by the user, but resulting from possible electrical and mechanical failure of the radio remote control.

Such function checks the neutral (rest) position of the actuators that control the machine's movements. Each time one of those actuators is operated, the transmitting unit sends both the movement command and the "SAFETY" command.

1.8 Identifying the radio remote control

As required by standard IEC 60204-32, each radio remote control is uniquely identified through a serial number (SERIAL N. or S/N).

The serial number is provided in the identification plate on each radio remote control unit. This is the only reference to be used both for maintenance operations and for declarations to competent bodies.



Plates on the units must not be:

- removed from their position (removal voids the guarantee)
- altered or damaged (contact Autec for replacement)

2 Risk assessment

When using and installing an industrial radio remote control it is therefore always necessary to evaluate if the machine can be radio remote controlled.

In fact, as required by standards ISO 12100 and ISO 14121, all machines must undergo risk assessment and related analysis.

The radio remote control can only be installed and used if this assessment gives positive results.

	<p>The machine manufacturer and/or the person who decides upon radio remote control installation and use is responsible for this risk assessment.</p>
---	--

Autec cannot be held responsible if this assessment has not been carried out correctly or is incomplete.

If required by the risk assessment, implement protection measures to prevent, reduce and report potential hazardous situations.

2.1 Risk assessment for radio remote controlled machines

When carrying out risk assessment for the machine or for the system where the radio remote control is installed, the following must be considered:

- some machines cannot be radio remote controlled: check for forbidden applications (see paragraph 1.3)
- the radio link between the two units may be interrupted due to persistent disturbance or interference.
- all warnings related to installation, use and maintenance provided by Autec must be taken into account

2.1.1 Aspects related to radio link

Whenever the radio link is interrupted (i.e. stop, low battery, automatic switch off, receiving unit not powered):

- all outputs of the receiving unit are disabled
- it is not possible to enable or disable the machine commands through the transmitting unit until the radio remote control is started up again.

2.1.2 Delay in command response time

	<p>Due to the characteristics of radio propagation (i.e.: EM interference, out-of-working-range condition), a delay up to the "Maximum stop time" may occasionally occur from the moment a command in the transmitting unit is released to the moment its corresponding output in the receiving unit is deactivated.</p>
---	---

Those who decide upon the installation of the radio remote control must make sure that this delay never leads to a dangerous situation in the specific uses.

2.1.3 Protection from unintended activation

The transmitting unit housing is manufactured so that it protects the actuators from unintentional activation, while meeting at the same time the operating needs, the comfort requirements and law limits.

Assessment shall be made to establish possible additional protection measures for the actuators (i.e. commands requiring two-hand operation, "dead-man" function) if particular environments, equipment and working modes could cause accidental bumps to the actuators.

2.1.4 Command activation and loss of command

Please consider that it is possible to unintentionally activate a command and/or involuntarily lose the selection of a command. Such anomalous events may be caused by electro-mechanical or mechanical damages in the "machine+radio remote control" system.

Carefully evaluate the possible consequences of such malfunction.

If required by the risk assessment, implement protection measures to prevent, reduce and report potential hazardous situations.

2.2 Staff training

All installation, usage and maintenance operations must be carried out by qualified technicians who are suitably trained with respect to:

- warnings resulting from risk assessment
- regulations and reference laws
- instructions and warnings provided in the documents related to the industrial radio remote control and to the radio remote controlled machine
- instructions provided by those who install the radio remote control on the machine and by the person in charge for safety in the workplace where the system "machine+radio remote control" is used

2.3 Working conditions

To guarantee correct radio remote control operation, all current regulations regarding safety at work and accident prevention should be respected. Furthermore, always respect all national regulations regarding the use of both the machine and the radio remote control valid in the country where the "machine+radio remote control" system is used.

Autec cannot be held responsible if the radio remote control is used in unlawful working conditions.

3 Warnings for installation

Besides instructions established by the machine's manufacturers, installers must always observe the following warnings.

3.1 General

 WARNING	<p>Respect and enforce the provisions of all reference standards relevant in the concerned application field (i.e. IEC 60204-32 for hoisting machines.)</p> <p>Always follow the instructions provided in the technical data sheet and respect values given in the technical data to carry out correct installation.</p> <p>The electrical connection of the receiving unit must meet the requirements set by clause 9.1 of standard IEC 60204-1 and/or standard IEC 60204-32.</p>
--	---

3.2 Mounting and fastening the receiving unit in the best position

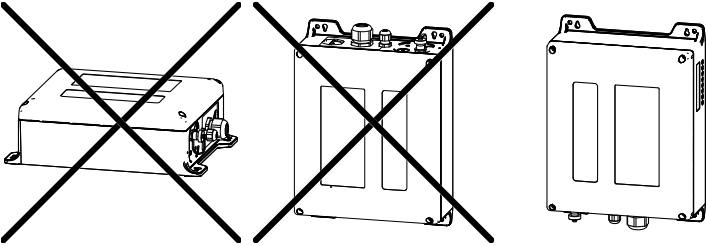
 WARNING	<p>Place the receiving unit so that it can be easily reached in case of need.</p> <p>Place the receiving unit vertically, with the cable gland or plug facing down.</p> <div style="text-align: center;"></div>
--	---

 WARNING	<p>Fix the receiving unit in four points, using the specific holes in the housing.</p> <p>Do not perforate the receiving unit in any case.</p> <p>When installing on machines that vibrate, it is recommended to fix the receiving unit to the machine with the appropriate vibration dampers.</p>
--	---

3.3 Positioning the antenna

If this warning is disregarded, the radio remote control working range may be reduced.

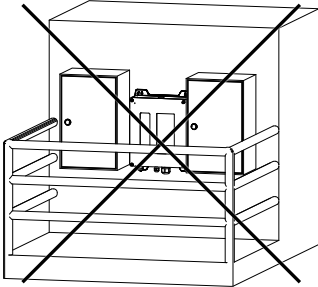
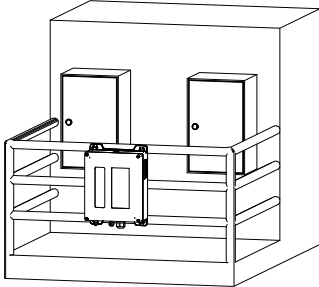
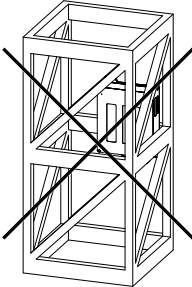
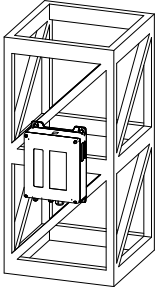
 WARNING	<p>The antenna is inside the receiving unit. Hence, install the receiving unit towards the working area, so that shields, structures or materials do not obstruct the radio link. In particular, the receiving unit must be placed at least 50 cm far from metal objects in its surroundings and never inside closed metal containers.</p> <div style="display: flex; justify-content: space-around; align-items: center;"><div style="text-align: center;"></div><div style="text-align: center;"></div></div> <div style="display: flex; justify-content: space-around; align-items: center;"><div style="text-align: center;"></div><div style="text-align: center;"></div></div>
---	---

WARNING: If the receiving unit is shielded by metal structures or is installed inside metal cabinets, use the appropriate extension kit for the antenna. In this case, install the antenna in a vertical position, and if possible towards the working area.

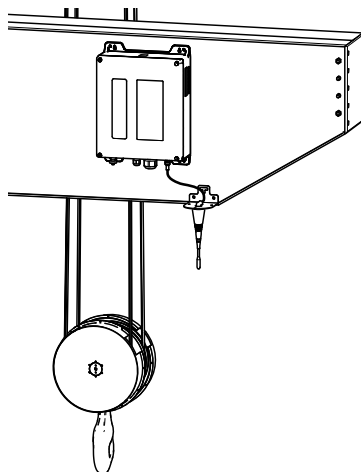
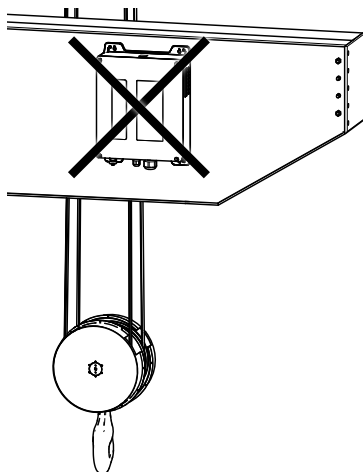
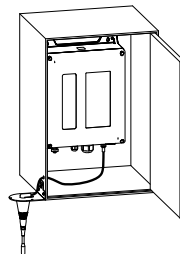
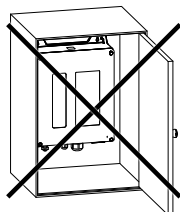

3.4 Wiring

The power supply of the receiving unit must be connected using an omnipolar switch with a switch-contact gap of at least 3 mm, that allows power supply disconnection during installation, wiring and/or maintenance operations.

The receiving unit's power supply must be protected against short circuit by means of an external device (e.g. fuse, thermal magnetic circuit breaker). Such device must be able to interrupt the maximum fault current (including the short circuit current) allowed in the circuit.

Receiving units powered with AC and exposed to transient overvoltages exceeding those of overvoltage category II, require additional protections that must be provided outside of the receiving units themselves.

If the receiving unit is powered with direct current, the power supply must come:

- from a power supply unit with a safety isolating transformer, or
- from a 12/24V battery.



Relay outputs of receiving unit's commands are dimensioned so as to control power loads. Contacts of those outputs are protected by means of over-voltage suppressors (varistors), to ensure the maximum lifetime of relays in most applications.

Suppressors connected in parallel with contacts of commands' relays may be incompatible with the connection to a high-impedance load (e.g. some PLCs); please contact Autec to perform correct installation.

Loads connected to the relay outputs must ensure the minimum power, voltage and current value that the contacts can switch with good reliability (300mW, 5V, 5mA). Connect an additional load to the outputs if necessary.

If a receiving unit's output (be it a solid state output or the contact of a relay) controls a DC inductive load (i.e. solenoid valves, relays), it is advisable to connect a recovery diode in anti-parallel with the driven load, to reduce the effects of demagnetizing currents.

Pay special attention to currents and voltages flowing in the **SAFETY** and **STOP** outputs: they shall not exceed the maximum permitted values (see technical data of the receiving unit).

To obtain the protection from unintended movements from the rest position, connect the contact of the **SAFETY** relay in series with the movement commands.

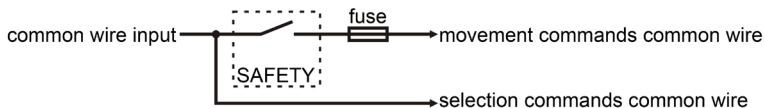

WARNING

The **STOP** circuit in the receiving unit has two contacts connected in series through a wire jumper (manufacturer's standard wiring). If the machine needs a **STOP** circuit with two separate contacts (four wires), this bridge can be removed. In this case, the installer is responsible for wiring in a way that assures the required safety level.

Group the wiring away from the electronic module, in order to avoid interferences and hazards related to electrical safety.

Evaluate the radio remote control's wiring and remember that if the output dedicated to the machine's horn, siren or blinker is used for another command due to application's and/or functional reasons, some procedures in the "Configuration Menu" may result unavailable later on.



To wire the terminals corresponding to the commands' outputs, to the **STOP** outputs and to the **SAFETY** outputs, it is recommended to use a slot screwdriver with a tip size of 3.5x0.4mm.

3.5 At end of installation

 DANGER	<p>Make sure that during installation the protection measures on the radio remote control and/or in the machine have not been made ineffective by possible procedures carried out.</p>
---	---

 WARNING	<p>Look up in the technical data sheet and check that the frequency band set in the radio remote control is permitted in the country of use.</p> <p>Correctly close the receiving unit so that the protection degree from dust and water is not jeopardised: check that the gasket is intact, correctly put the housing parts one over the other so that they overlap, and tighten the screws.</p>
--	--

3.6 Testing

The installer must check and complete the technical data sheet in all its parts, adding the date the system has been put into service, his stamp and signature.

 WARNING	<p>After installing and wiring the receiving unit, test the system “machine+radio remote control”, and check that the operations carried out correspond exactly to the commands sent (in particular check the STOP command).</p> <p>In case of malfunction, disable the system “machine+radio remote control” until the problem has been completely solved.</p>
---	---

4 Warnings for use

In addition to all instructions provided by the machine manufacturer, by the installer of the radio remote control and by the person responsible for the safety of the work area, users shall always respect the following warnings.

4.1 Before starting to work

 DANGER	<p>Stand in a position that allows the direct supervision of the remote controlled machine and its load, and stay in a place ensuring the user's safety conditions in respect of other operations and/or activities and/or processes that are carried out in the working environment.</p> <p>Always check that the mechanical operation of the STOP pushbutton is correct. If it is impossible or difficult to press this pushbutton, do not use the radio remote control.</p>
--	--

 WARNING	<p>Never start up or use the transmitting unit if the working conditions present the risk of losing balance or tripping.</p> <p>Only start up the transmitting unit when starting work: improper use may cause hazardous situations.</p> <p>Never start up or use the transmitting unit in closed spaces, with the machine not in sight, or outside the radio remote control working range: in such cases it is in fact still possible to build a radio link, thus causing the risk that unwanted commands be carried out by the machine.</p> <p>Get familiar with the correspondence between the actuators and the machine's movements (this is indicated in the attached technical data sheet) and learn symbols on the transmitting unit's panel (symbols used are defined by the machine manufacturer and/or installer depending on the machine's operation and functions).</p>
--	---

4.2 During normal operation



Pay attention to the entire work area. Immediately press the STOP pushbutton when a hazardous situation occurs.



Visually and directly follow all movements of the machine and its load and remain inside the radio remote control working range.

Pay particular attention to warnings and visual and acoustic signals, and take all measurements and steps to avoid that movements of the remote controlled machine may lead to hazardous situations for people and/or property.

In case of malfunction, disable the system "machine+radio remote control" until the problem has been completely solved.

Pay attention to low battery signals: all dangerous operations (e.g. hanging load) must be concluded before it is completely flat..

Use the transmitting unit in a simple and comfortable way, avoiding accidental falls. The pouch, the waist belt and the shoulder harness provided with the radio remote control are used for that purpose.

4.3 After using the radio remote control



Switch off the transmitting unit when work is stopped or temporarily interrupted. Do not leave the load hanging (even when charging the unit or changing the battery).

Never leave the transmitting unit unguarded in order to prevent unauthorised use.

If an "Key ID 0-1" is in the transmitting unit, always store it in a safe place each time it is removed. If this key is lost, the radio remote control cannot work, since the transmitting unit needs the address stored in the key to work with its receiving unit.

5 Radio remote control life cycle

To ensure safe and long-lasting operation of industrial radio remote controls, carefully follow the instructions provided for each stage of the product life cycle.

5.1 Transportation and storage

	Radio remote controls must always be transported and stored inside their packing until they are installed on the machine.
---	---

Environmental transportation and storage conditions are given in the following table.

	Temperature	Relative Humidity	Air Pressure
Transportation	Class 2K4 -40°C to +70°C (-40°F to +158°F)	Class 2K4 95%	Class 2K4 70kPa to 106kPa
Storage	Class 1K5 -40°C to +70°C (-40°F to +158°F)	Class 1K3 5% to 95%	Class 1K5 70kPa to 106kPa

5.2 Installation

	<p>The radio remote control can only be installed and tested by competent staff that masters the technical knowledge required to carry out these procedures and is qualified according to the regulation of the country where the radio remote control is mounted.</p> <p>Only if the radio remote control is installed correctly can it be used safely.</p>
--	--

 WARNING	<p>Always follow the instructions provided in the technical data sheet to carry out correct installation.</p> <p>Please contact the machine manufacturer or the person who decided upon the installation of the radio remote control for instructions and warnings regarding the installation.</p>
--	--

All warnings for correct installation are given in chapter 3.

All instructions for correct installation are given in "Part D" of the manual (related to the receiving unit).

5.3 Use

The use of industrial radio remote controls is strictly limited to skilled and properly trained personnel.

All warnings for correct use are given in chapter 4.

All instructions for correct use are given in "Part C" of the manual (related to the transmitting unit).

Environmental working conditions are given in the following table.

	Temperature	Relative Humidity	Air Pressure
Use of the transmitting unit	Class 4K4H -20°C to +55°C (-4°F to +130°F)	Class 4K4H 4% to 100%	Class 4K4H 70kPa to 106kPa
Use of the receiving unit	Class 4K4H -20°C to +70°C (-4°F to +158°F)		

5.4 Radio remote control maintenance

The following instructions provide information to safely carry out routine and special maintenance operations for the radio remote control.

They shall be completed by:

- instructions provided by the machine manufacturer
- directions provided by the installer of the radio remote control on the machine
- regulations regarding safety at work and accident prevention in force in the country where the radio remote control is used.

All fine-tuning, checking and maintenance actions carried out on the radio remote control shall be verified and recorded by the person in charge of carrying out maintenance on the machine.

 <p>DANGER</p>	<p>Before any maintenance operation, disconnect power supply from the receiving unit.</p> <p>After each maintenance operation, always make sure that all commands sent by the transmitting unit only activate the corresponding expected operations.</p>
--	--

	<p>In case of malfunction or damaged parts, disable the system “machine+radio remote control” until the problem has been completely solved.</p> <p>After each maintenance operation, if a unit has been opened, close it correctly, in order not to endanger its protection degree from dust and water: check that the gasket is intact, correctly overlay the two parts of the housing and tighten the screws.</p>
---	---

5.4.1 Routine maintenance

Routine maintenance consists of operations needed to preserve the radio remote control normal usage conditions, thus implementing fine-tuning, checks, planned replacement actions that necessarily arise from the normal use of the product.

All given instructions must be followed correctly at each commissioning, that is:

- whenever the radio remote control and/or the machine is installed or assembled
- whenever the machine location/position changes
- after special maintenance.

Routine maintenance carried out as described in this manual is fundamental for using the radio remote control safely.

Special applications may need more specific routine maintenance actions to be carried out at different periods (i.e. if the working environment is particularly dirty, in case of heavy applications or if the system is used very frequently, some maintenance actions may be required more frequently, depending on the decision of the person in charge for safety in the work site).

5.4.2 Daily routine maintenance

Before starting to work:

- make sure that the transmitting unit panel symbols can be easily recognised and replace the panel if necessary
- check that the three plates on the transmitting unit are readable and intact
- make sure that the mechanical operation of the STOP pushbutton is correct
- check structural integrity of the transmitting unit.

During normal operation:

- avoid causing structural damage to the transmitting unit
- make sure that materials that could endanger the transmitting unit usage and safety (such as concrete, sand, lime, dust) do not deposit on it.

After using the radio remote control:

- clean the transmitting unit: never use solvents or flammable/corrosive materials and do not use high-pressure water cleaners or steam cleaners
- store the transmitting unit in clean and dry areas.

5.4.3 Three-month routine maintenance

Every three months:

- remove dust or deposit of material from the receiving unit: never use solvents or flammable/corrosive materials to clean it, and do not use high-pressure water cleaners or steam cleaners
- check structural integrity of the receiving unit
- make sure that the wiring of the receiving unit is intact and connected
- make sure that the receiving unit panel symbols can be easily recognised and replace the panel if necessary
- check that the plates on the receiving unit are readable and intact.

5.4.4 Six-month routine maintenance

Every six months:

- check the correct correspondence between the commands that are sent and the manoeuvres that are carried out by the machine
- check that the contact of the SAFETY relay is open when no movement command has been sent. This is safety critical maintenance: it is necessary to keep a record (date, signature, comments) showing that this check has been regularly carried out. Keep the record together with other installation documents.
- make sure that all the relay contacts of the receiving unit operate correctly, and check that the contact closes when the corresponding manoeuvre is enabled and opens when the manoeuvre is disabled.
- start up the radio remote control and check in the receiving unit that the STOP relay contacts close. Then, press the STOP pushbutton and check in the receiving unit that the STOP relay contacts open.



Before testing the STOP relays, make sure that no dangerous situations may arise due to the closing of the STOP relay contacts of the receiving unit.

5.4.5 Special maintenance

Special maintenance consists of repairs needed due to radio remote control failure, damage or malfunction, carried out with the aim of restoring the original usage and working conditions.

	<p>Prior to contacting the support service technicians:</p> <ul style="list-style-type: none">- read and understand all documents related to the radio remote control, and make sure that all the instructions they contain have been accomplished correctly- follow the instructions to detect possible malfunctions and their origins. <p>Any fault should be repaired by authorised personnel only (contact the support service of the machine's manufacturer), using original Autec spare parts only.</p>
---	--









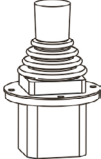

The following radio remote control data must be reported in order to make interventions faster and more reliable:

- radio remote control serial number
- purchase date (given on the certificate of guarantee)
- description of the problem found
- address and telephone number of the place where the device is being used (with the name of the person to contact)
- local supplier.

5.4.6 Preventive replacement of actuators (joysticks, pushbuttons and selectors)

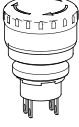
Each actuator on the transmitting units can be used for a maximum number of operations.

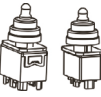
 WARNING	<p>Replace joysticks, pushbuttons and selectors on the transmitting unit before they reach the maximum number of operations, even though they are still working.</p> <p>Replacement prevents possible failures that may lead to loss of safety.</p>
--	---

Actuator	Max. operations	Actuator	Max. operations
	5×10^6		5×10^6
	5×10^6		10^6
	3×10^6		6×10^6
	25×10^4		5×10^4
	10^5		10^6
	10^6		

5.5 Machine maintenance

Follow instructions provided by the machine manufacturer and by the installer of the radio remote control, in order to carry out machine maintenance.

	<p>When carrying out maintenance on the machine, always disconnect power supply from the receiving unit. In the event of necessary maintenance on the machine (i.e. soldering), disconnect all the electrical connections of the receiving unit.</p>
---	---

5.6 Disposal

When disposing of a radio remote control, give it to the waste separate collecting services in the user's country.

6 Troubleshooting

When the radio remote control does not work:

- bring the transmitting unit close to the receiving unit to avoid radio interference and disturbances
- establish whether the problem lies with the radio remote control or with the machine. Therefore, before any inspection, try to control the machine from a control unit different from the radio remote control, if present. If the problem persists, it lies with the machine. If not, the problem may lie with the radio remote control. In such case, please refer to paragraph 6.3.

6.1 Radio remote controls with Data Feedback function

It is still possible that the transmitting unit sends commands to control the machine even if the Data Feedback function does not work properly, or if there is no information and/or signals coming from it.

To check that the radio remote control works properly, please refer to paragraph 6.3.

 CAUTION	<p>When the display or the LED array does not work, please contact the support service of the machine manufacturer, even if no one of the problems indicated in paragraph 6.3 has been detected.</p>
--	---

6.2 Radio remote controls with wire control

Please refer to paragraph 6.3 to check that the radio remote control works properly. Possibly use the wire control to check if radio interference occurs.

On the contrary, if you want to check that the wire control works properly:

- connect the cable to the transmitting unit and to the machine
- check that the manoeuvres carried out by the machine correspond to the commands sent by the transmitting unit.

6.3 Solutions in case of malfunction

Look up in “Part C” and/or in “Part D” of the manual to identify the radio remote control malfunction signalled by light signals on the units.

If the problem persists after the suggested solution has been carried out, contact the support service of the machine manufacturer.

