

C26PRO SERIES PRO-M

 **autec**[®]
RADIO REMOTE CONTROL

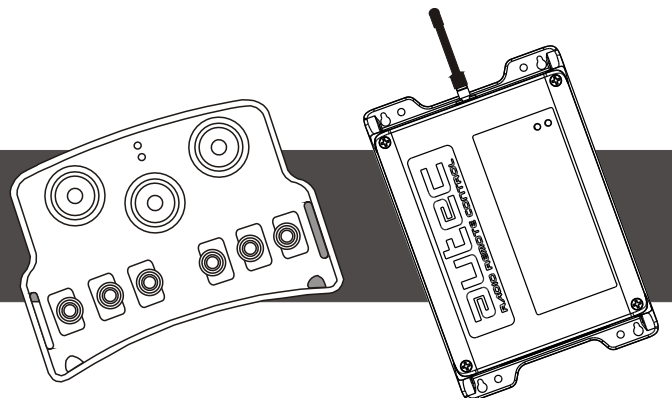

C26PRO SERIES PRO-M

Carefully read the instructions and warnings about the system or the equipment in which the KTC is installed.

Should the manual be damaged or lost, ask AUTECH for a copy of the manual Specifying the KTC serial number.

Contact AUTECH if any of the instructions and/or warnings given in this manual are not clear.

The information contained in this manual is subject to modification without notice and is not binding.

No parts of this manual may be produced by any means without the written permission of AUTECH (including recording and photocopying).

1 CONVENTIONS

Any pieces of text written in **bold** should be read very carefully.



This symbol highlights extremely important indications and information which, if not observed, can create seriously dangerous situations for people, equipment or property.



This symbol highlights all important indications and information that deal with operation.

2 CONFORMITY

The C26 PRO series PRO-M radio remote control is in conformity with FCC Rules (Part 90 for the transmitting unit and Part 15 for the receiving unit).

Operation is subject to the following two conditions:

**(1) this device may not cause harmful interference, and
(2) this device must accept any interference received, including interference that may cause undesired operation.**



Changes or modifications not expressly approved by the party responsible for compliance could void the user's authority to operate the equipment.

In Technical Data (see chapter 15) there are the characteristics of safety functions according with EN 954-1.

All machines must undergo a risk analysis; therefore it is necessary to evaluate, within the limits of this analysis, if the machine can be radio remote controlled.

The machine producer and/or the person who decides upon radio remote control use and installation is responsible for this analysis.

Autec, or its distributors, cannot be held responsible if the risk analysis is not carried out correctly and if the radio remote control is installed on applications that are different from those permitted:



PERMITTED APPLICATIONS:

Hoisting and moving machines installed exclusively on vehicles that use a battery as electrical power supply source (for example: hydraulic cranes, concrete pumps...)

FORBIDDEN APPLICATIONS

- machines installed in areas where equipment with explosion-proof characteristics are being used



- AC supplied machines

- machines using a DC supply that does not come from a battery

- machines where risk analysis regarding verification of radio remote control conformity to the application is not possible or has given a negative or uncertain result.

To guarantee correct radio remote control operation, all current regulations regarding safety at work and accident prevention should be respected. All applicable standards and regulations valid in the user country regarding the use of both the machine and the radio remote control MUST ALWAYS be respected.

Autec cannot be held responsible if the radio remote control is used in unlawful working conditions.

System must be installed by a licensed technician and in accordance with all relevant local, state/provincial and federal regulations, including but not limited to NEC, OSHA, CE etc.

3 RADIO REMOTE CONTROL DESCRIPTION

Industrial radio remote controls are used to command machines from a distance. Each industrial radio remote control is made up of a portable transmitting unit, from which the user can remotely control the machine, and a receiving unit installed on board the machine itself. The transmitting unit sends a coded message over radio frequency transmission. This message contains a value called "address", which lets the receiving unit decode only the messages coming from its own transmitting unit (the one that has the same address).

This ensures that no interference can activate any command. If the radio frequency transmission is disturbed, incorrect or interrupted, the receiving unit autonomously stops the whole system.

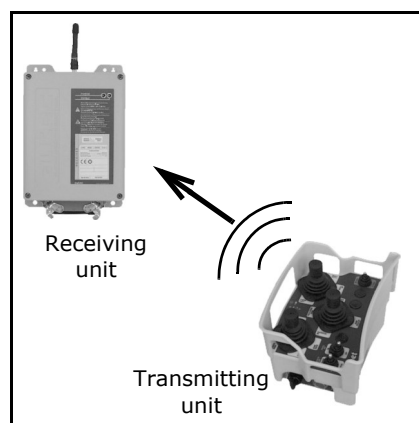

4 WARNINGS REGARDING INSTALLATION



FAILURE TO COMPLY WITH THE FOLLOWING WARNINGS MAY RESULT IN SERIOUS INJURY OR DEATH TO PERSONNEL AND DAMAGE TO EQUIPMENT.



Installation must only be carried out by qualified people and in accordance with the standards and regulations in the country in which the system is to be installed. Only a correct installation can ensure the necessary level of safety during subsequent radio remote control use.

General indications

Respect the machine operational characteristics when connecting the Radio remote control. **The safety circuits on the radio remote control and/or present on the machine should not be bypassed (or excluded).**

The receiving unit wiring can be configured very easily, therefore it can be installed without having to modify the machine. Do not modify the machine electric panel without the machine manufacturer authorization.



Disconnect the receiving unit by detaching all the electrical connections each time some welding operation is performed on the machine.

Installation

The receiving unit must be placed in a position that favours reception of the signals issued by the transmitting unit.

It should therefore be assembled vertically (antenna upwards). The receiving unit should also be easily accessible to permit operation under safe conditions.

If the receiving unit is covered by metal structures or installed inside metal panels, use the appropriate extension kit for external antennas.

The antenna must never come into contact with metal parts.

It is forbidden to pierce the receiving unit casing. Doing so compromises the protection degree against external agents (level IP65).

The vehicle creates vibrations, therefore antivibration blocks must always be used to reduce the effect that these vibrations have on the receiving unit.

The receiving unit must be positioned away from heat sources (exhaust pipes, alternators, radiators etc.)

Wiring

Most machines are connected to the receiving unit by multiple-pole plugs which permit quick disconnection of the radio remote control for replacement with a hard wired

(cabled) control. This connecting technique is advisable even if the machine is not originally equipped for it.

The reliability of the installation is largely dependent on the quality of the wiring, and connections should therefore be made to the highest standards using multi-core or single-core cables of suitable cross-sectional area for the current to be carried. **Cables should also be flame retardant** (for further information refer to IEC 60204 - 1).

Oil resistant cables should be used for connections external to the receiving unit.



The receiving unit power supply must pass through an isolation switch to permit power disconnection during installation, wiring and/or maintenance operations.

To improve radio remote control operation, connect the receiving unit immediately downstream of the machine main switch.

It is always advisable to check the supply voltage even under maximum load; in this way the maximum variations can be verified (the limit values of tolerated deviation are given both in the Technical Data and on the technical data sheet of the Radio remote control).



Receiving unit supply voltage fluctuations that exceed the limit values can compromise regular radio remote control operation.

The C26-PRO series radio remote controls are equipped with circuits to protect against unintended movements from standstill of the actuators if the wiring indications indicated in the technical data sheet are respected.

Proportional output setting

Autec supplies the radio remote control with the proportional output values already set depending on the valve type(s). During installation, these values must be verified and, if necessary, modified according to machine function and operator preference (see chapter 12).

Testing

When installation and wiring have been completed, always do the following:

- make sure that when the radio remote control STOP pushbutton is pressed the machine goes into a **situation of safety** (through direct action on the general solenoid valve of the main circuit), **the motor possibly switches off** and, if present, **the main line contactor opens** to remove voltage.
- make sure that the manoeuvres carried out by the machine and which have been commanded by the transmitting unit **correspond exactly** (this correspondence is given in the technical data sheet)
- check **safety circuit** operation (a simple way of doing this is to remove fuse F3, housed on the main board of the Receiving Unit. Make sure that in these conditions no movement command can be carried out, then insert the F3 fuse again and check correct operation)



The installer must also compile and/or verify the two copies of the technical data sheet, where the wiring layout between the receiving unit and the machine is given. The first copy of the technical data sheet is inside the receiving unit, the second is annexed to the user's manual. The installer must put the date of installation, sign and stamp both copies.

5 WARNINGS REGARDING USE



FAILURE TO COMPLY WITH THE FOLLOWING WARNINGS MAY RESULT IN SERIOUS INJURY OR DEATH TO PERSONNEL AND DAMAGE TO EQUIPMENT.



The radio remote control can only be used by operators who:

- have read and understood this manual,
- are qualified and trained,
- know the "radio remote control + machine" system well.



The radio remote control can only be used by operators who:

- have read and understood this manual,

- are qualified and trained,
- know the "radio remote control + machine" system well.



Autec, or its distributors, cannot be held responsible if the radio remote control is installed on applications other than those permitted and if used in irregular working conditions.



Each time the transmitting unit is powered, make sure that the STOP pushbutton operates correctly and that, when pressed, machine movement is interrupted instantly. If this does not occur, do not use the radio remote control.



The operator should always ensure that both units are complete and that the gaskets, bellows and hoods of the actuators (joysticks, selectors, pushbutton) are whole. If not, the radio remote control must not be used before being repaired.



To work efficiently and to prevent possible emergency situations, it is necessary to select a position from where it is possible to:

- remain inside the typical working range of the radio remote control (see chapter 15)
- visually follow the machine, its movements and its load at all times.

During operation



The operator must:

- switch off the transmitting unit each time work is stopped
- NEVER leave the transmitting unit unattended with the starting keyswitch inserted
- avoid working if the battery is almost flat.



The operator should never switch on or activate the transmitting unit unless ready to start working. A radio link can be created even outside the active range and from enclosed places, creating the possibility for the radio remote controlled machine to carry out undesired commands.

In case of danger



If a dangerous situation arises, the operator must intervene immediately by pressing the STOP pushbutton, which instantly interrupts machine movement.



As not all hazards are caused by the "radio remote control + machine" system, the operator should be careful even when emergency situations are present in the work area. The operator should, also in this case, intervene manually by activating the STOP command.

In case of fault



In case of faults or damaged parts, ALWAYS STOP the "radio remote control + machine" system until the problem has been resolved. Any damaged part can ONLY be replaced by authorized Autec personnel and only using original Autec spare parts.

6 WARNINGS REGARDING ROUTINE MAINTENANCE



While carrying out routine and special maintenance on the radio remote control and the machine, remove the battery from the transmitting unit and disconnect the connection plug from the receiving unit.

All control and maintenance procedures carried out on the radio remote control must be verified and recorded by the person in charge of carrying out maintenance on the machine.

Routine maintenance carried out as described in this manual is fundamental for using the radio remote control safely.



After each maintenance procedure, always make sure that only the expected manoeuvres are carried out when the relative commands are sent by the transmitting unit.

Summary

The prescriptions that follow should be considered as the minimum necessary for safe and correct radio remote control operation. Special applications may need more specific routine maintenance procedures to be carried out at different periods.

These recommendations may never be considered as forming a contract, nor replace any local, state or federal regulations concerning workplace safety. Furthermore, these recommendations do not limit the responsibilities of the purchaser and/or user of the radio remote control regarding safe work practices.

All the mentioned prescriptions must be carried out each time the machine and the radio remote control are put into service.

PERIODIC CONTROLS				
Component	Interval			
	Daily	Every 3 months	Every 6 months	Every 12 months
Transmitting unit	X			
Receiving unit		X		
Electrical operation			X	
External electrical conductors				X



If irregularities are noted while carrying out routine maintenance, put the "machine+radio remote control" system out of order, following the indications given (see chapter 7).

Transmitting unit

The following must be completed daily:

1. remove dust or accumulations of other material from the transmitting unit. Never use solvents or flammable/corrosive materials to clean, and do not use high pressure water cleaners or steam cleaners.
2. store the transmitting unit in clean and dry areas.
3. make sure the transmitting unit's gaskets, joystick bellows, selectors caps and pushbuttons are intact, soft and elastic
4. make sure that the battery seat and the battery contacts are always clean
5. make sure that the transmitting unit is structurally sound
6. make sure that the panel symbols can be easily recognized. If necessary, replace the panel.
7. check identification plate readability and integrity

Receiving unit

The following must be done every 3 months:

1. remove dust or accumulations of other material from the receiving unit. Never use solvents or flammable/corrosive materials to clean, and do not use high pressure water cleaners or steam cleaners.
2. make sure that the receiving unit is structurally sound
3. verify the integrity and connection of the internal wiring to the receiving unit
4. make sure that the panel symbols can be easily seen. If necessary, replace the panel.
5. check identification plate readability and integrity

Electrical operation

The following must be done every 6 months:

1. make sure that all the relay contacts of the receiving unit operate correctly, controlling contact closing when the corresponding manoeuvre is enabled and contact opening when the manoeuvre is disabled.
2. verify the correct correspondence between the commands that are sent and the manoeuvres that are carried out.

External electric conductors

The following must be done every 12 months:

1. verify integrity along the full length of the cable which connects the receiving unit to the machine.
2. verify the integrity and the electrical connection of the plugs and the connection socket

3. verify and if necessary replace the strips or other fixing systems
4. make sure that the connecting cable has not deteriorated, particularly at the cable entry point.

7 WARNINGS REGARDING SPECIAL MAINTENANCE



While carrying out special maintenance on the radio remote control and the machine, remove the battery from the transmitting unit and disconnect the connecting plug from the receiving unit.



Any fault should be repaired by authorized Autec personnel (contact Service), using original Autec spare parts only.

The following radio remote control data must be communicated in order to permit faster and more reliable service:

- serial number
- purchase date (given on the guarantee certificate)
- problem found
- address and telephone number of the place where the device is being used (with the name of the person to contact)
- supplier.

It is better to have read and understood all parts of this manual, and made sure that all the instructions it contains have been followed correctly before contacting the Service Technicians.

8 DOCUMENTATION



The minimum documentation indicated below is always supplied with the industrial radio remote control:

- instruction and warnings manual
- battery charger manual
- the radio remote control technical data sheet



Make sure that these documents are present. If they are not, please request them from Autec or an authorized representative, specifying the radio remote control serial number.

Instruction and warnings manual

This manual is an integral part of the radio remote control and its safety functions and gives the main information necessary for installing, using and carrying out maintenance on the radio remote control.

All installation, usage and maintenance operations must be carried out exclusively by qualified technicians who are suitably trained in relevant norms and laws.

As a minimum, the radio remote control owner, installer, user and the person in charge of its maintenance must therefore read and understand each part of this manual.

Follow the instructions and warnings given by the machine producer regarding the machine controlled by the radio remote control.

If this manual is lost or damaged, ask for a copy from Autec or its authorized representative. Please specify the serial number of the relative radio remote control. The information contained in this manual is subject to modification without notice and is not binding.

No parts of this manual may be reproduced by any means without the written permission of Autec (including recording and photocopying).

Technical data sheet

The technical data sheet shows the wiring system between the receiving unit and the machine. It should be filled out and checked by the installer, who has the responsibility of a correct wiring.

Once all necessary checks have taken place, the installer must undersign the technical data sheet, which must be kept with the user's manual (always keep a copy of this data sheet in case it could be required).

Identification plates

The radio remote control identification data are written on a technical data plate both on the transmitting unit and on the receiving unit.

The plates MUST NOT be removed from where they are placed. If damaged, please contact Autec or an authorized representative for a replacement.

9 TRANSMITTING UNIT AND HOW IT WORKS

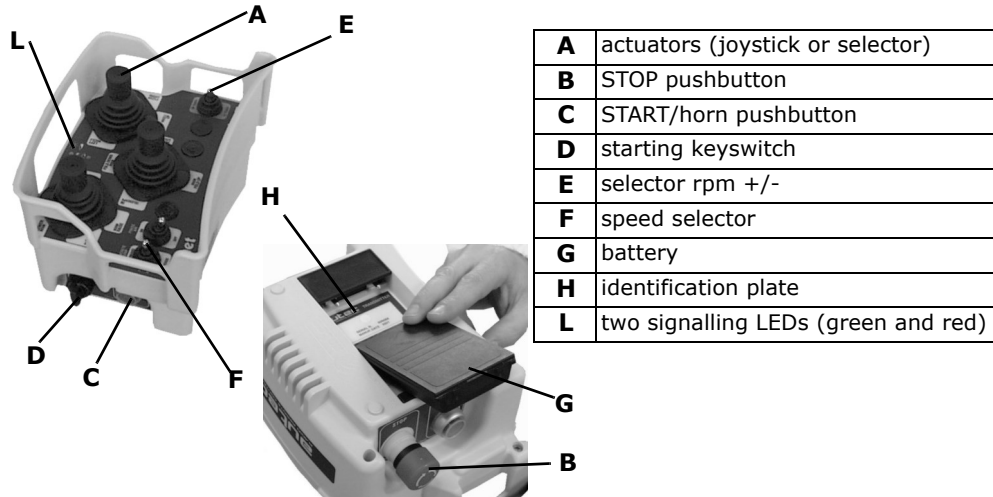

Power on and start up

Check that the starting keyswitch is in position "O", gently insert the battery in its housing. Check that the STOP pushbutton has not been pressed and that none of the actuators are out of their respective neutral positions.

Turn the starting keyswitch to "I", activate the START pushbutton and release it when the green light starts to flash.



➡ **The transmitting unit only switches on if the battery has sufficient charge and if all the actuators are inactive.**

Commands

It is possible to control the radio remote machine only after the transmitting unit has been radio linked to the receiving unit (signalled by the lighting up of the ENABLE pilot light on the receiving unit (see chapter 10)).

After the radio link is established, machine movements are available by acting on the proper actuators.

All commands protected by the SAFETY function are approved to category 3 of EN 954 - 1 against the undesired movements when in the standstill position (UMFS - Unintended Movement From Standstill).

Some transmitting unit commands are given below:

Horn

With the transmitting unit switched on, press the START pushbutton: the machine horn/alarm activates.

STOP

To immediately stop the machine, press the STOP pushbutton: the transmitting unit switches off automatically.

To start working again, rotate the STOP pushbutton in the direction indicated and repeat the power on and start up procedures.



The STOP pushbutton must be used each time the machine has to be stopped immediately due to a dangerous situation.

The STOP circuit is approved in category 4 according to the EN 954 -1.

RPM +/-

This selector works in two ways:

1. during normal operation: increases (rpm +) or decreases (rpm -) the machine motor turns
2. during the set-up phase REMOTE SET UP: see chapter 12



Speed selector

A speed selector may be present, which makes the machine operate at different speeds as necessary. This selector can have two, three or four positions which respectively activate two, three or four speed levels.

Frequency change

In case of interference or conflict with other radio systems, it is possible to change the radio frequency being used.

With the transmitting unit powered and started, keep the START pushbutton pressed for 5-6 seconds: a prolonged beep accompanied by the switching on of both signalling LEDs indicate that the frequency has changed. During this operation the receiving unit switches off: press the START pushbutton again to start working normally.

LED signals

Some transmitting unit operating conditions are signalled by two signalling LEDs (one green and one red):

Signal type	LED	
	green	red
Slow blinking	normal operation	/
Quick blinking	Warning that the battery is almost discharged	Warning that the battery is discharged
Continuous light on starting *	/	Command operated during start up
Both LEDs steadily lit simultaneously	Frequency change occurred	

* accompanied by an acoustic signal

When the battery is approximately 90% discharged, the green light will start flashing at a faster rate to inform the operator that the battery requires recharging. If the operator continues to use the radio control, approximately 3 minutes before the battery is fully discharged, the red light will start flashing and an acoustic alarm will sound. In this situation, the operator must return the machine to a condition of safety (by pressing the stop pushbutton), switch off the transmitting unit, and recharge the battery or fit a fully charged battery.

Power off

Turn the ignition key to "O".
Always remember to remove the starting keyswitch and put it in a safe place.

Automatic power off

The transmitting unit can switch off automatically when:

- the battery is not sufficiently charged and/or
- the radio remote control has not been used for 3 and a half minutes (to deactivate automatic switching off, please contact Autec authorized personnel).

Recharging the battery

Remove the battery from the transmitting unit and insert in the battery charger. The "ON CHARGING" light will illuminate to indicate that the battery is being charged. Once the battery is fully charged, the "END OF CHARGE" light will illuminate. Battery charging should be performed at an ambient temperature within the range +5°C to +45°C.



See the supplied manual for all instructions, warnings and technical data regarding the batteries and the battery charger.

10 RECEIVING UNIT

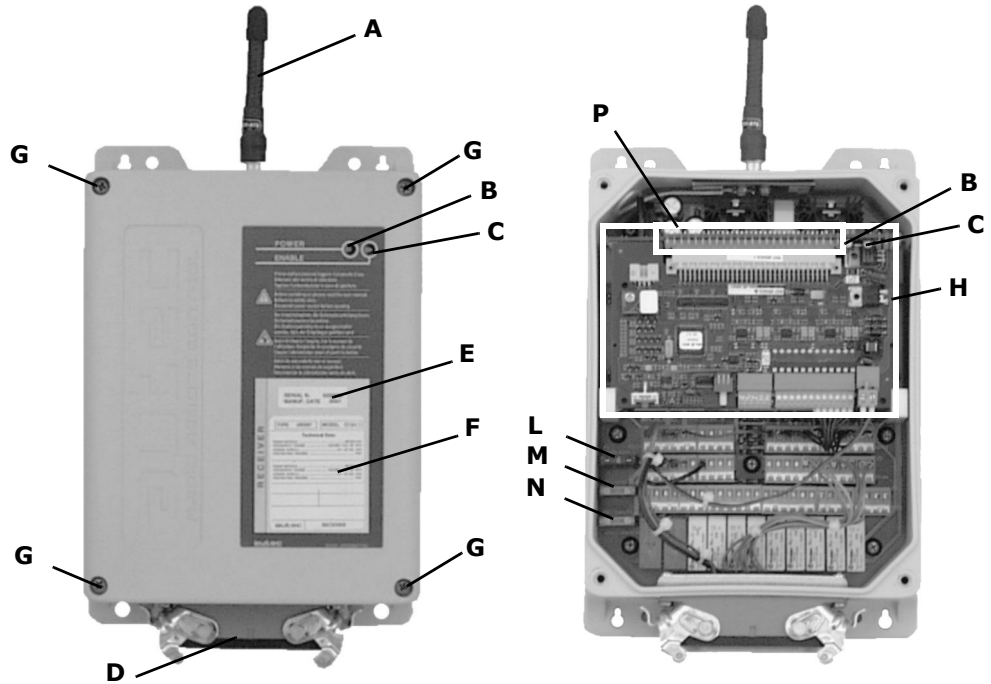

A	antenna
B	POWER light
C	ENABLE light
D	connecting plug
E	identification plate
F	technical data plate
G	closing screws

B	POWER light
C	ENABLE light
H	RI97-08PVZA module
L	fuse F1 (POWER SUPPLY)
M	fuse F2 (STOP)
N	fuse F3 (SAFETY)
P	internal LEDs

External signalling

The POWER light indicates the presence (on) or not (off) of the power supply in the receiving unit

The ENABLE light indicates that the connection between the transmitting unit and the receiving unit is enabled (on) or disabled (off).

When the receiving unit is powered, proper operation is indicated when:

- POWER and ENABLE lights on, with transmitting unit on;
- POWER light on and ENABLE off, with transmitting unit off.

Internal signalling

The LEDs that are present show when a relay has activated: when a LED switches on, this indicates that the relative command relay given in the following drawing (also present inside the receiving lid cover) has been activated:

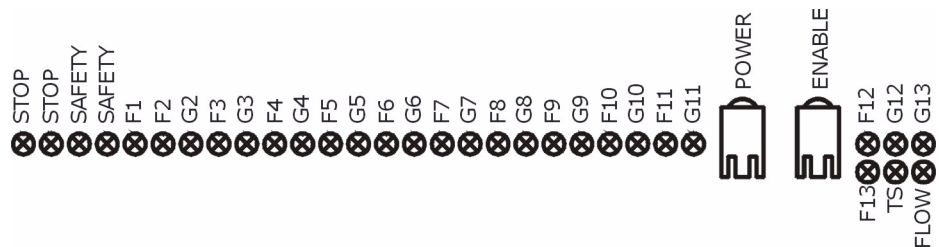

SAFETY

The radio remote control is equipped with a safety function called SAFETY which protects the system from involuntary movements caused by possible radio remote control faults.

This function constantly controls the rest position (neutral) of the movement actuators in the transmitting unit and is available on the receiving unit SAFETY relay output.

FLOW

Activating a movement command also activates the FLOW function: this commands the solenoid valve which puts the oil in the hydraulic circuit of the main distributor under pressure.

T.S.

T.S. (TIMED STOP) is the command that switches off the machine diesel motor: it remains active for 10 seconds after the STOP pushbutton has been pressed.

Fuse

The three fuses inside the receiving unit have the following characteristics:

Fuse	Function	Technical Data
F1	POWER SUPPLY circuit protection	4A (32Vdc, autofuse)
F2	STOP circuit protection	10A (32Vdc, autofuse)
F3	SAFETY circuit protection	10A (32Vdc, autofuse)

11 RI97-08PVZA MODULE

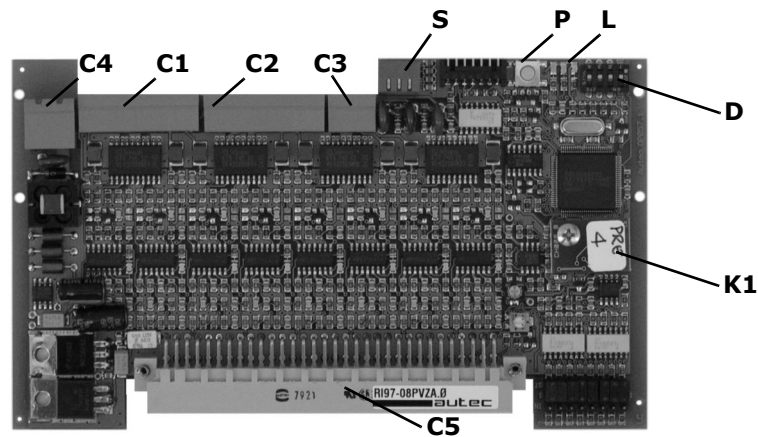

C1	connector for the proportional voltage-outputs
C2	connector for the proportional current-outputs (PWM)
C3	connector for the on/off inputs
C4	connector for the power supply
C5	connector for the connection to the bus board
D	dip switches
K1	data memory
L	LEDs
P	initial calibration restore pushbutton
S	rotary switch for calibration

Dip switches

A group of 4 dip switches is present on the RI97-08PVZA module: they are used to program some functions.

DIP	Pos.	FUNCTION
1	ON	the REMOTE SET UP function is active (compulsory position during the calibration of the proportional output)
	OFF	the REMOTE SET UP function is not active (compulsory position during the normal functioning of the radio remote control)
2	ON	the transmitting unit has a speed selector with 2 or more speed levels
	OFF	the transmitting unit has a speed selector that dynamically increases and decreases the functioning speed
3	/	do not modify the present programming
4	/	not used

Data memory

The proportional output calibration values are stored in the removable data memory.

Restore pushbutton

To reset the initial proportional output values, press the restore pushbutton P until the yellow LED stops blinking and remains on.

Rotary switch

The rotary switch S is used during the REMOTE SET UP calibration procedure (see chapter 12): each of its positions corresponds to a specific parameter to be adjusted (positions 6 to 9 are not used).

LED

Three LEDs are present:

- the red LED indicates the status and integrity of the data memory
- the green LED indicates the status and integrity of the RI97-08PVZA module
- the yellow LED indicates the status of the REMOTE SET UP function

Signal type	LEDs		
	red	green	yellow
Steady light	/	/	the initial values of the proportional output are reset when the restore pushbutton P is pressed
Blinking	data memory is damaged	the RI97-08PVZA module is powered and functioning *	the REMOTE SET UP function is active (DIP 1 is ON)
Light switched off	the data memory is functioning	the RI97-08PVZA module is not powered and is not functioning	the REMOTE SET UP function is not active (DIP 1 is OFF)
* if the blinking is slow, there is no radio link between the transmitting and the receiving unit			

Inputs

When each of these three inputs is active the values of the proportional outputs changes overriding the function of the speed selector (if present on the transmitting unit).

12 PROPORTIONAL OUTPUT SETTING PROCEDURE (REMOTE SET UP)



Calibration of the proportional outputs must only be set by qualified and trained personnel who understand and respect all the warnings given in chapters 4, 5, 6 and 7.

The proportional outputs of RI97-08PVZA module are programmed at the values given on the relevant technical data sheet.



Never leave the DIP 1 in ON when the radio remote control is working: this position is compulsory during the calibration phase and, when inserted, only one proportional command can be activated at a time.

Preparation for calibration

1. Make sure that the transmitting unit is switched off.
2. Remove power from the receiving unit.
3. Open the receiving unit and position the DIP 1 in ON.
4. Power the receiving unit.
5. Switch on and start up the transmitting unit.
6. Turn the starting keyswitch to the " " (REMOTE SET UP) position.

Calibration

7. Select one or more positions of the rotary switch S on the RI97-08PVZA module to calibrate the related parameters.
8. Operate the RPM+/- selector on the transmitting unit (where the + increases the speed that is being calibrated and - decreases it).



Moving the joystick outside of the standstill position during the calibration, a horn/alarm sounds for 0.5 seconds signalling that the minimum calibration zone is approaching.



If a speed selector with 2 or more pre-set levels is present on the transmitting unit, calibration is to be performed for each of the selector positions.



If the RI97-08PVZA module inputs are used on the receiving unit, calibration is performed for each of these inputs activating them in sequence.

Module calibration

Position 0: dither frequency (for PWM output only)

When the rotary switch S is at 0, the PWM (current) dither frequency can be adjusted. This value should not normally be modified. If necessary operate on the RPM+/- selector on the transmitting unit to modify the desired value

Position 1: minimum and maximum values for Z2-Z7 outputs

The maximum and minimum values of the two semiaxis of each joystick are adjusted with the rotary switch S in position 1. Proceed as follows:

- To set the maximum value, take the joystick to the maximum range of the semiaxis to be calibrated. Keep the same position and use the toggle switch RPM +/- to set the desired value.
- Once the maximum values have been set, take the joystick just out of the standstill position of the semiaxis to be calibrated to set the minimum values. Keep the same position and use the toggle switch RPM +/- to set the desired value.

Position 2: output value when the joystick is in the standstill position

The voltage value corresponding to the joystick standstill position is adjusted with the rotary switch S in position 2. This value should not normally be modified. If necessary proceed as follows:

- take any joystick out of the standstill position
- Keep the same position and use the toggle switch RPM +/- to set the desired value.

Position 3: maximum and minimum Z8 output values

Position 4: maximum and minimum Z9 output values

When the rotary switch S is at 3 and 4, it is possible to regulate the maximum and minimum values of auxiliary outputs Z8 and Z9 respectively. Proceed as follows:

- To fix the maximum value, use the related actuator (on the transmitting unit) and take it to its end limit. Keep the same position and use the RPM +/- toggle switch to set the desired value.
- Once the maximum value has been set, use the related actuator (on the transmitting unit) and take it to the beginning to fix the minimum value. Keep the same position and use the toggle switch RPM +/- to set the desired value.

Position 5: inversion of the movement direction

The direction of the movement is inverted with the rotary switch S in position 5 (for the powered outputs only). Proceed as follows:

- position the joystick of the axis to be inverted outside the standstill position
- keep this position and position the RPM+/- selector on the transmitting unit to + to invert the direction of the semiaxis, and to - to reset the semiaxis direction.

Saving the calibration

9. Switch off the transmitting unit to save the calibration.
10. Remove power from the receiving unit.
11. Position DIP 1 to OFF.
12. Close the receiving unit and connect the power supply.

13 RADIO FREQUENCIES

A radio remote control can be programmed in AUTOMATIC SCAN or MANUAL SELECTION.

Automatic scan

A radio remote control is normally programmed by the manufacturer in the following manner: it can therefore operate in any of the available frequencies. In cases of interference or conflict with other systems, the working frequency can be changed (see paragraph "Frequency change") without having to touch the inside of either the transmitting or the receiving units.

Manual selection



Only contact Autec authorized personnel if the working radio frequency has to be set in this manner.

Using the radio remote control in the manual selection mode makes it possible to work at a specific frequency. To set this frequency, you must set the dip switches located in the transmitting and receiving modules.

14 DIAGNOSTICS

If the system "radio remote control + machine" does not start, check if the problem is caused by the radio remote control or the machine. Therefore, before carrying out any verification connect the alternative control unit: if the machine does not start, the problem lies with the machine itself.

If, on the other hand, the machine only starts normally when started by the alternative control unit, the problem lies with the radio remote control. In this case, perform the following checks.

Diagnosics of transmitting unit

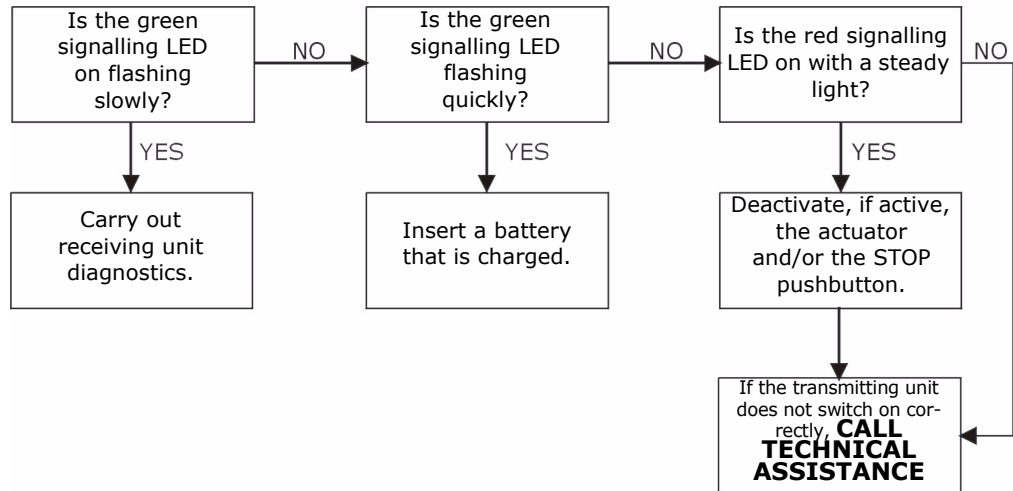

Diagnosics of receiving unit

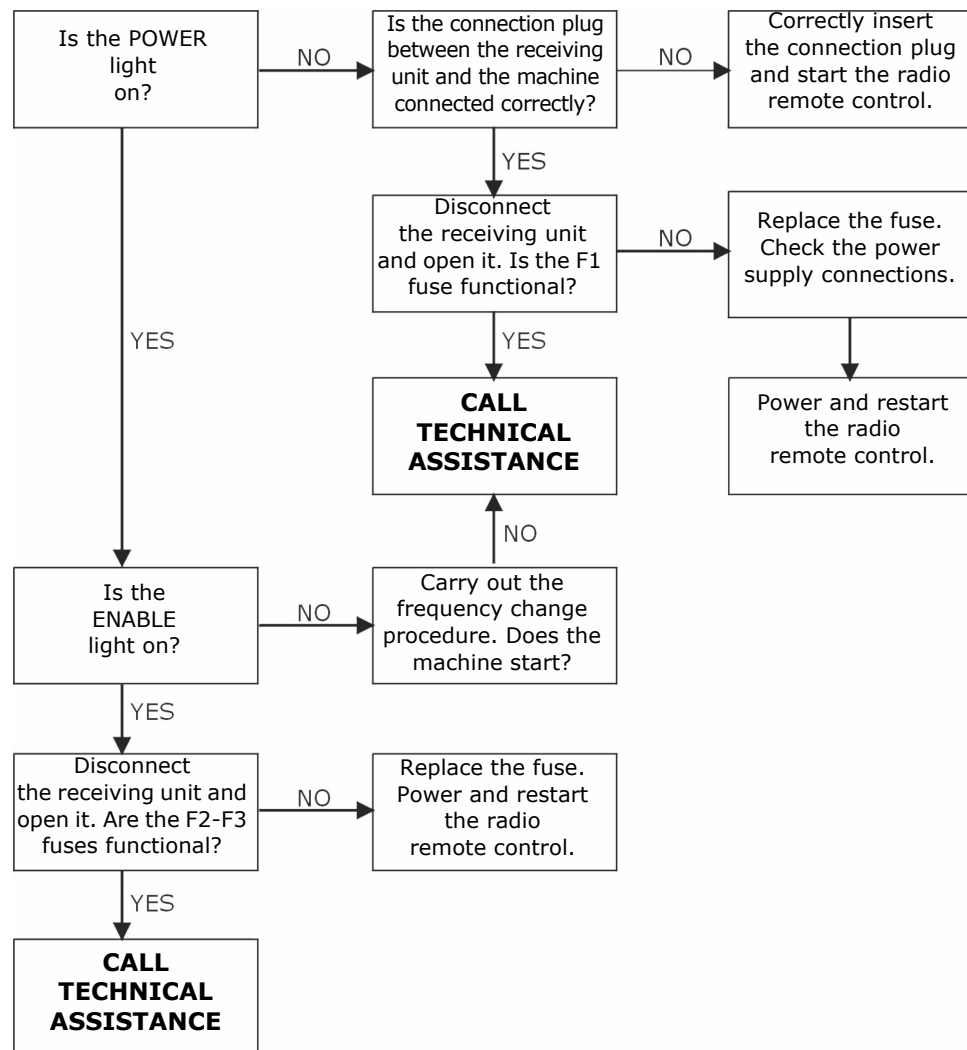

15 TECHNICAL DATA

General

Working frequency	902 - 928 MHz in 9 sub-bands (3.2 MHz each)
Programmable radio channel	64 in any sub-band (manual selection mode)
.....	16 groups of 8 frequencies in any sub-band (automatic scan mode)
Channel spacing.....	25 kHz (option 12.5 kHz)
Hamming distance.....	≥ 8
Probability of undetected error.....	$< 10^{-11}$
Typical working range.....	150 m
Passive emergency time.....	0.5/1.5 sec
Command response time.....	70 - 120 ms
STOP command response time.....	70 - 120 ms

Safety function category according to the EN 954 - 1

STOP protection	Cat. 4
Protection against unintended movements from standstill position of the actuators	Cat. 3

Transmitting unit

Number of available commands	6+2 analog+12 on/off + start + stop
Antenna.....	internal
Type of modulation.....	GFSK
Transmitting power (433 MHz).....	< 10 mW
Transmitting power (870 MHz).....	< 5 mW
Power supply: battery pack	NiMH 7.2V - 1.3 Ah
Turn off voltage	6.0 V
Battery capacity with fully charged battery (at 20°C)	about 10 hours
"Flat battery" warning.....	about 3 min.
Working temperature.....	(-5°F) - (+130°F) [(-20°C) - (+55°C)]
Housing	PA6 fg 20%
Protection degree.....	NEMA 4 [IP65]
Dimensions	(9.3" x 6.3" x 6.8") [(263 x 160 x 173) mm]
Weight (with battery)	4.4 lbs [2 kg]

Receiving unit

Power supply.....	8 - 30 Vdc (< 40 W)
Antenna.....	external
Max rated current of STOP and SAFETY relay contacts.....	10 A (30 Vdc)
Max rated current of movement command relay contacts	4 A (30 Vdc)
Max rated current of selection command relay contacts	6 A (30 Vdc)
Receiver sensitivity	0,5µV per 20 dB SINAD
Working temperature.....	(-5°F) - (+160°F) [(-20°C) - (+70°C)]
Housing	PA6 fg 20%
Protection degree.....	NEMA 4 [IP65]
Dimensions	(7.1" x 9.1" x 3.7") [(180 x 230 x 95) mm]
Weight.....	6.2 lbs [2.8 kg]
Drilling template	A = 5.8" [148 mm] B = 4.6" [116 mm] C = 10.0" [253 mm] D = 10.0" [253 mm]

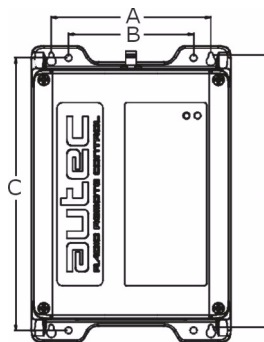

Battery charger and battery

Technical data inside the related manual

