

AUTEL®

MaxiSys™

User Manual

Wireless Diagnostic Interface

WQ83017BTDIAG



August 2013

FAST. SMART. MOBILE. POWERFUL.

Trademarks

Autel[®], MaxiSys[™], MaxiDAS[®], MaxiScan[®], MaxiTPMS[®], MaxiVideo[™], MaxiRecorder[™], and MaxiCheck[™] are trademarks of Autel Intelligent Technology Co., Ltd, registered in China, the United States and other countries. All other marks are trademarks or registered trademarks of their respective holders.

Copyright Information

No part of this manual may be reproduced, stored in a retrieval system or transmitted, in any form or by any means, electronic, mechanical, photocopying, recording, or otherwise, without the prior written permission of Autel.

Disclaimer of Warranties and Limitation of Liabilities

All information, specifications and illustrations in this manual are based on the latest information available at the time of printing. Autel reserves the right to make changes at any time without notice. While information of this manual has been carefully checked for accuracy, no guarantee is given to the completeness and correctness of the contents, including but not limited to the product specifications, functions, and illustrations.

Autel will not be liable for any direct damages or for any special, incidental, or indirect damages or for any economic consequential damages (including lost profits).

IMPORTANT: Before operating or maintaining this unit, please read this manual carefully paying extra attention to the safety warnings and precautions.

For Services and Support:



www.maxidas.com
www.auteltech.com



1-877-288-3587/1-877-AUTELUS (North America)

0086-755-86147779 (China)



Support@auteltech.com

For technical assistance in all other markets, please contact your local selling agent

Safety Information

For your own safety and the safety of others, and to prevent damage to the equipment and vehicles upon which it is used, it is important that the safety instructions herein presented throughout this manual be read and understood by all persons operating, or coming into contact with, the equipment.

There are various procedures, techniques, tools, and parts for servicing vehicles, as well as in the skill of the individual doing the work. Because of the vast number of test applications and variations in the products that can be tested with this instrument, we cannot possibly anticipate or provide advice or safety messages to cover every situation. It is the automotive technician's responsibility to be knowledgeable of the system being tested. It is essential to use proper service methods and test procedures. It is important to perform tests in an appropriate and acceptable manner that does not endanger your safety, the safety of others in the work area, the equipment being used, or the vehicle being tested.

Before using the equipment, always refer to and follow the safety messages and applicable test procedures provided by the manufacturer of the vehicle or equipment being tested. Use the equipment only as described in this manual. Read, understand, and follow all safety messages and instructions in this manual.

Safety Messages

Safety messages are provided to help prevent personal injury and equipment damage. All safety messages are introduced by a signal word indicating the hazard level.



DANGER: Indicates an imminently hazardous situation which, if not avoided, will result in death or serious injury to the operator or to bystanders.



WARNING: Indicates a potentially hazardous situation which, if not avoided, could result in death or serious injury to the operator or to bystanders.

Safety Instructions

The safety messages herein cover situations Autel is aware of. Autel cannot know, evaluate or advise you as to all of the possible hazards. You must be certain that any condition or service procedure encountered do not jeopardize your personal safety.



DANGER: When an engine is operating, keep the service area **WELL VENTILATED** or attach a building exhaust removal system to the engine exhaust system. Engines produce carbon monoxide, an odorless, poisonous gas that causes slower reaction time and can lead to serious personal injury or loss of life.

**WARNINGS:**

- Always perform automotive testing in a safe environment.
- Wear safety eye protection that meets ANSI standards.
- Keep clothing, hair, hands, tools, test equipment, etc. away from all moving or hot engine parts.
- Operate the vehicle in a well ventilated work area, for exhaust gases are poisonous.
- Put the transmission in PARK (for automatic transmission) or NEUTRAL (for manual transmission) and make sure the parking brake is engaged.
- Put blocks in front of the drive wheels and never leave the vehicle unattended while testing.
- Use extreme caution when working around the ignition coil, distributor cap, ignition wires and spark plugs. These components create hazardous voltages when the engine is running.
- Keep a fire extinguisher suitable for gasoline, chemical, and electrical fires nearby.
- Do not connect or disconnect any test equipment while the ignition is on or the engine is running.
- Keep the test equipment dry, clean, free from oil, water or grease. Use a mild detergent on a clean cloth to clean the outside of the equipment as necessary.
- Do not drive the vehicle and operate the test equipment at the same time. Any distraction may cause an accident.
- Refer to the service manual for the vehicle being serviced and adhere to all diagnostic procedures and precautions. Failure to do so may result in personal injury or damage to the test equipment.
- To avoid damaging the test equipment or generating false data, make sure the vehicle battery is fully charged and the connection to the vehicle DLC is clean and secure.
- Do not place the test equipment on the distributor of the vehicle. Strong electro-magnetic interference can damage the equipment.

Contents

SAFETY INFORMATION	III
CHAPTER 1 USING THIS MANUAL	1
1.1 CONVENTIONS	1
1.1.1 <i>Bold Text</i>	1
1.1.2 <i>Notes and Important Messages</i>	1
1.1.3 <i>Hyperlinks</i>	1
1.1.4 <i>Procedures</i>	1
CHAPTER 2 INTRODUCTION	3
2.1 MAXISYS DISPLAY TABLET	3
2.1.1 <i>Functional Description</i>	3
2.1.2 <i>Power Sources</i>	5
2.1.3 <i>Technical Specifications</i>	6
2.2 VCI – BLUETOOTH DIAGNOSTIC INTERFACE	7
2.2.1 <i>Functional Description</i>	7
2.2.2 <i>Technical Specifications</i>	8
2.2.3 <i>Power Sources</i>	8
2.3 VCI – J2534 ECU PROGRAMMING DEVICE	8
2.3.1 <i>Functional Description</i>	8
2.3.2 <i>Power Sources</i>	10
2.3.3 <i>Technical Specifications</i>	10
2.4 ACCESSORY KIT	11
2.4.1 <i>Main Cable</i>	11
2.4.2 <i>OBD-I Adapters</i>	11
2.4.3 <i>Other Accessories</i>	12
CHAPTER 3 GETTING STARTED	14
3.1 POWERING UP.....	14
3.1.1 <i>Application Buttons</i>	15
3.1.2 <i>Locator and Navigation Buttons</i>	16
3.1.3 <i>System Status Icons</i>	17
3.2 POWERING DOWN	17
3.2.1 <i>Reboot System</i>	18
3.3 INSTALL COMPUTER SOFTWARE.....	18
3.3.1 <i>Printing Operation</i>	19
CHAPTER 4 DIAGNOSTICS OPERATIONS	20
4.1 VEHICLE CONNECTION.....	20

4.1.1	<i>No Communication Message</i>	22
4.2	GETTING STARTED	22
4.2.1	<i>Vehicle Menu Layout</i>	23
4.3	VEHICLE IDENTIFICATION	24
4.3.1	<i>Auto VIN Scan</i>	25
4.3.2	<i>Manual VIN Input</i>	25
4.3.3	<i>Manual Vehicle Selection</i>	26
4.3.4	<i>Alternative Vehicle Identification</i>	29
4.4	NAVIGATION	29
4.4.1	<i>Diagnostics Screen Layout</i>	29
4.4.2	<i>Screen Messages</i>	32
4.4.3	<i>Making Selections</i>	33
4.5	OPERATIONS	33
4.5.1	<i>Diagnosis</i>	34
4.5.2	<i>ECU Information</i>	38
4.5.3	<i>Read Codes</i>	38
4.5.4	<i>Erase Codes</i>	39
4.5.5	<i>Live Data</i>	40
4.5.6	<i>Active Test</i>	46
4.5.7	<i>Programming and Coding</i>	47
4.6	GENERIC OBD II OPERATIONS	51
4.6.1	<i>General Procedure</i>	51
4.6.2	<i>Function Descriptions</i>	53
4.7	EXITING DIAGNOSTICS	56
CHAPTER 5	DATA MANAGER OPERATIONS	57
5.1	OPERATIONS	57
5.1.1	<i>Image Files</i>	57
5.1.2	<i>PDF Files</i>	59
5.1.3	<i>Review Data</i>	60
5.1.4	<i>Apps Manager (Coming soon)</i>	60
5.1.5	<i>Message (Coming soon)</i>	61
5.1.6	<i>Data Logging (Coming soon)</i>	61
CHAPTER 6	MAXICLOUD OPERATIONS	62
6.1	NAVIGATION	62
6.1.1	<i>Terminology</i>	64
6.2	OPERATIONS	65
6.2.1	<i>Home</i>	65
6.2.2	<i>My Cloud</i>	66
6.2.3	<i>Search Fix</i>	68

6.2.4	Q&A.....	69
6.2.5	Support.....	69
CHAPTER 7	SETTINGS OPERATIONS	70
7.1	OPERATIONS.....	70
7.1.1	Unit.....	70
7.1.2	Language.....	70
7.1.3	Printing Setting.....	71
7.1.4	Wired Network	71
7.1.5	Push Message.....	72
7.1.6	About.....	73
7.1.7	System Settings	73
CHAPTER 8	SHOP MANAGER OPERATIONS	74
8.1	VEHICLE HISTORY	74
8.1.1	Historical Test Record	76
8.2	WORKSHOP INFORMATION.....	77
8.3	CUSTOMER MANAGER	78
CHAPTER 9	UPDATE OPERATION	82
CHAPTER 10	VCI MANAGER OPERATIONS.....	84
10.1	BLUETOOTH PAIRING	85
10.2	WIRED NETWORK CONNECTION	86
CHAPTER 11	REMOTE DESK OPERATIONS	88
11.1	OPERATIONS.....	88
CHAPTER 12	SUPPORT OPERATIONS.....	90
12.1	PRODUCT REGISTRATION	90
12.2	SUPPORT SCREEN LAYOUT	91
12.3	MY ACCOUNT	92
12.4	USER COMPLAINT	92
12.5	SUPPORT COMMUNITIES	95
12.6	TRAINING CHANNELS.....	97
12.7	FAQ DATABASE	98
CHAPTER 13	REMOTE PROGRAM OPERATIONS (COMING SOON)	99
CHAPTER 14	TRAINING OPERATIONS.....	99
CHAPTER 15	QUICK LINK OPERATIONS	101

CHAPTER 16 DIGITAL INSPECTION OPERATIONS102

16.1 ADDITIONAL ACCESSORIES 103

16.2 OPERATIONS 105

CHAPTER 17 SCOPE OPERATIONS (COMING SOON)107

CHAPTER 18 MAINTENANCE AND SERVICE108

18.1 MAINTENANCE INSTRUCTIONS..... 108

18.2 TROUBLESHOOTING CHECKLIST 109

18.3 ABOUT BATTERY USAGE 109

18.4 SERVICE PROCEDURES..... 110

CHAPTER 19 WARRANTY112

Chapter 1 Using This Manual

This manual contains tool usage instructions.

Some illustrations shown in this manual may contain modules and optional equipment that are not included on your system. Contact your sales representative for availability of other modules and optional equipment.

1.1 Conventions

The following conventions are used.

1.1.1 Bold Text

Bold emphasis is used to highlight selectable items such as buttons and menu options.

Example:

- Tap **OK**.

1.1.2 Notes and Important Messages

The following messages are used.

Notes

A **NOTE** provides helpful information such as additional explanations, tips, and comments.

Important

IMPORTANT indicates a situation which, if not avoided, may result in damage to the test equipment or vehicle.

1.1.3 Hyperlinks

Hyperlinks, or links, that take you to other related articles, procedures, and illustrations are available in electronic documents. Blue colored text indicates a selectable hyperlink.

1.1.4 Procedures

An arrow icon indicates a procedure.

Example:

➤ **To use the camera:**

- 1 Tap the **Camera** button. The camera screen opens.
- 2 Focus the image to be captured in the view finder.
- 3 Tap the blue circle. The view finder now shows the captured picture and auto-saves the taken photo.

Chapter 2 Introduction

The MaxiSys™ Diagnostic Platform is an evolutionary smart solution for specialized automotive diagnosis. Utilizing the powerful A9 quad-core 1.40GHz processor, and a 9.7 inch LED capacitive touch screen, combined with the best possible coverage of OE-level diagnostics, and based on the revolutionary multitask-capable Android Operating system, the MaxiSys organizes information with test instrumentation to help you diagnose symptoms, codes, and customer complaints easily, quickly and efficiently.

There are two main components to the MaxiSys system:

- MaxiSys Display Tablet -- the central processor and monitor for the system
- Vehicle Communication Interface (VCI) -- the device for accessing vehicle data

NOTE: Autel provides two optional VCI devices for your choice. One is the J2534 Programming Device; the other is the Bluetooth Diagnostic Interface, both will be introduced in this chapter.

This manual describes the construction and operation of these devices and how they work together to deliver diagnostic solutions.

2.1 MaxiSys Display Tablet

2.1.1 Functional Description

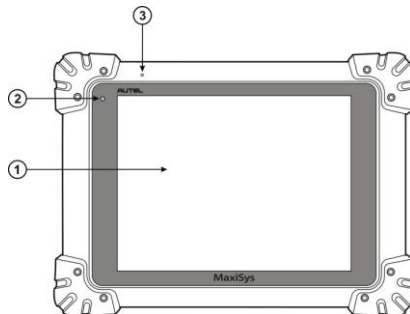

Figure 2-1 MaxiSys Front View

1. 9.7" LED Capacitive Touch Screen
2. Ambient Light Sensor – detects ambient brightness
3. Microphone

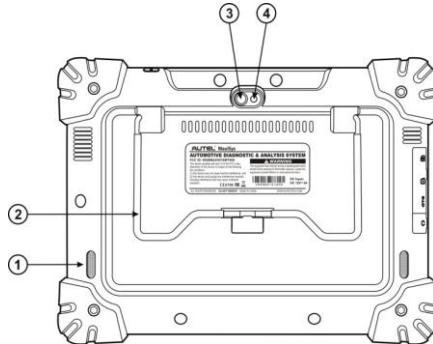

Figure 2-2 *MaxiSys Back View*

1. Audio Speaker
2. Collapsible Stand – extends from the back to allow hands-free viewing of the display tablet at a 30 degree angle
3. Camera Lens
4. Camera Flash

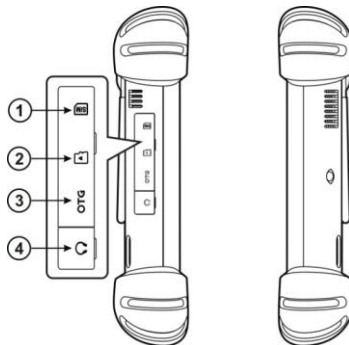

Figure 2-3 *MaxiSys Left Side*

1. SIM (subscriber identity module) Card Slot
2. Mini SD (secure digital) Card Slot
3. Mini USB (universal serial bus) OTG Port
4. Head Phone Jack

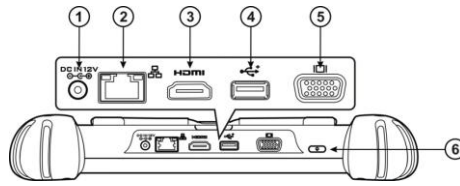

Figure 2-4 *MaxiSys Top View*

1. DC Power Supply Input Port
2. Ethernet Port
3. HDMI (high-definition multimedia interface) Port
4. USB Port
5. VGA (video graphics array) Port
6. Lock/Power Button – turns the MaxiSys tool on and off with long press, or locks the screen with short press

2.1.2 Power Sources

The MaxiSys Display Tablet can receive power from any of the following sources:

- Internal Battery Pack
- AC/DC Power Supply
- Vehicle Power

Internal Battery Pack

The display tablet can be powered with the internal rechargeable battery, which if fully charged can provide sufficient power for about 6.5 hours of continuous operation.

AC/DC Power Supply

The display tablet can be powered from a wall socket using the AC/DC power adapter. The AC/DC power supply also charges the internal battery pack.

Vehicle Power

The display tablet can be powered from the cigarette lighter or other suitable power port on the test vehicle through a direct cable connection. The vehicle power cable connects to the DC power supply port on the top side of the display unit.

2.1.3 Technical Specifications

Item	Description
Operating System	Android™ 4.0, Ice Cream Sandwich
Processor	Samsung Exynos Quad-Core Processor 1.4GHz
Memory	2GB RAM & 32GB On-board Memory
Display	9.7 inch LED capacitive touch screen with 1024x768P resolution
Connectivity	<ul style="list-style-type: none"> • Ethernet: RJ45 Ethernet Connection • Cellular: 3G/4G module: WCDMA&LTE • Wi-Fi (802.11 a/b/g/n) • USB: 2.0 • Bluetooth v.2.1 + EDR
Camera (rear)	Rear-facing, 5.0 Megapixel, AF with Flashlight
Sensors	Gravity Accelerometer, Ambient Light Sensor (ALS)
Audio Input/Output	<ul style="list-style-type: none"> • Microphone • Dual Speakers • 4-Band 3.5 mm stereotype/standard headset jack
Power and Battery	<ul style="list-style-type: none"> • 11000 mAh 3.7 V lithium-polymer battery • Charging via 12 V AC/DC power supply
Input Voltage	12 V (9-24 V)
Power Consumption	6.5 W
Operating Temperature	-10 to 55°C (14 to 131°F)
Storage Temperature	-20 to 70°C (-4 to 158°F)
Housing	Strong plastic housing with protective rubber boot
Dimensions (W x H x D)	300 mm (11.81") x 220 mm (8.66") x 50 mm (1.97")
Weight	NW: 1.42 kg (3.13 lb), MaxiSys GW: 8.655 kg (19.08 lb); MaxiSys Pro GW: 8.052 kg (17.75 lb)
Protocols	ISO 9142-2, ISO 14230-2, ISO 15765-4, K/L lins, Flashing Code, SAE-J1850 VPW, SAE-J1850 PWM, CAN ISO 11898, Highspeed, Middlespeed, Lowspeed and Singlewire CAN, GM UART, UART Echo Byte Protocol, Honda Diag-H Protocol, TP 2.0, TP 1.6, SAE J1939, SAE J1708, Fault-Tolerant CAN

2.2 VCI – Bluetooth Diagnostic Interface

2.2.1 Functional Description

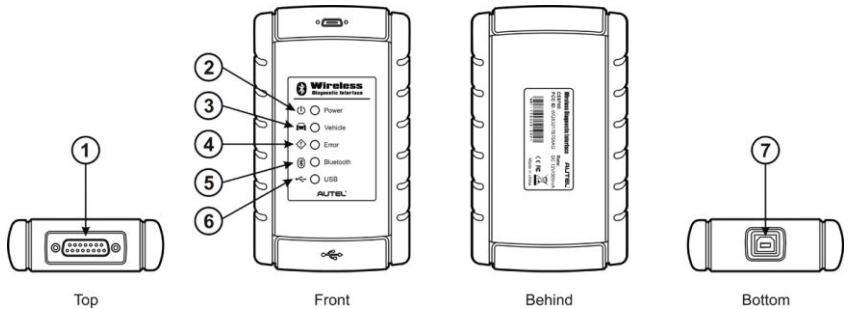

Figure 2-5 *Bluetooth Diagnostic Interface*

1. Vehicle Data Connector (DB15-Pin)
2. Power LED - illuminates solid green when powered on
3. Vehicle LED - flashes green when communicating with the vehicle's network
4. Error LED - illuminates solid red when serious hardware failure occurs; also flashes red when performing software/firmware update
5. Bluetooth LED - illuminates solid green when connected with the MaxiSys display tablet through Bluetooth communication; also flashes green when transmitting data between the vehicle and the display tablet
6. USB LED – illuminates solid green when the device is properly connected and communicating with the MaxiSys display tablet via the USB cable
7. USB Port

Communication

The Bluetooth Diagnostic Interface supports both Bluetooth and USB communication. It can transmit vehicle data to the MaxiSys Display Tablet with or without a physical connection. The working range of the transmitter through Bluetooth communication is about 980 feet (about 300 m). A signal lost due to moving out of range automatically restores itself when the display unit is brought closer to the VCI unit.

2.2.2 Technical Specifications

Item	Description
Communications	<ul style="list-style-type: none"> Bluetooth V.2.1 + EDR USB 2.0
Wireless Frequency	2.4 GHz
Input Voltage Range	12 VDC
Supply Current	300 mA @ 12 VDC
Operating Temperature	0°C to 50°C (ambient)
Storage Temperature	-20°C to 70°C (ambient)
Dimensions (L x W x H)	147.5 mm (5.80") x 85.5 mm (3.37") x 29.0 mm (1.14")
Weight	0.215 kg (0.473 lb)

2.2.3 Power Sources

The Bluetooth Diagnostic Interface operates on 12-volt vehicle power, which it receives through the vehicle data connection port. The unit powers on whenever it is connected to an OBD II/EOBD compliant data link connector (DLC).

2.3 VCI – J2534 ECU Programming Device

2.3.1 Functional Description

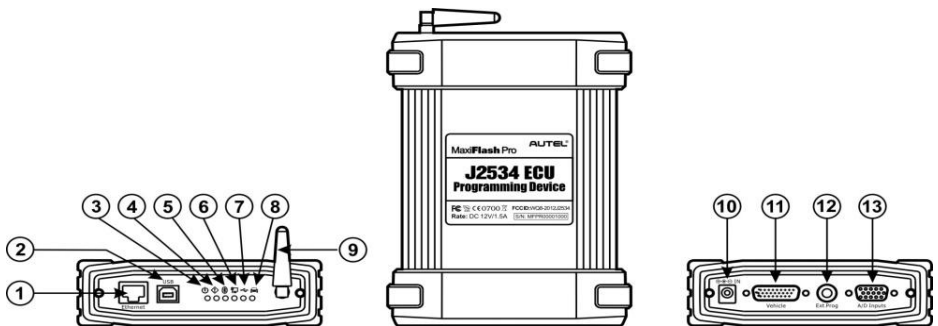

Figure 2-6 J2534 ECU Programming Device

1. Ethernet Port
2. USB Port
3. Power LED - illuminates solid green when powered on
4. Error LED - illuminates solid red when serious hardware failure occurs
5. Bluetooth LED - illuminates solid green when connected with the MaxiSys display tablet through Bluetooth communication
6. Ethernet LED - illuminates solid green when connected with the MaxiSys display tablet or an existing LAN via the Ethernet serial cable
7. USB Status Light -- illuminates solid green when the device is properly connected and communicating with the MaxiSys display tablet or the PC via the USB cable
8. Vehicle LED - flashes green when communicating with the vehicle's network

IMPORTANT: Do not disconnect the reprogramming device while this status light is on! If the flash reprogramming procedure is interrupted while the vehicle's ECU is blank or only partially programmed, the module may be unrecoverable.

9. Bluetooth Antenna
10. DC Power Supply Input Port
11. Vehicle Data Connector (DB26-Pin MVCI)
12. External Programming Voltage Output Port
13. A/D Input Port

J2534 Reprogramming Capability

The J2534 ECU Programming Device is a SAE J2534-1 & -2 compliant PassThru reprogramming interface device. Using the updated OEM software, it is capable of replacing the existing software/firmware in the Electronic Control Units (ECU), programming new ECUs and fixing software-controlled drivability issues and emission issues.

Communication

The J2534 ECU programming device supports Bluetooth, Ethernet and USB communication. It can transmit vehicle data to the MaxiSys display tablet with or without a physical connection. The working range of the transmitter through Bluetooth communication is 980 feet (about 300 m). A signal lost due to moving out of range automatically restores itself when the display tablet unit is brought closer to the VCI unit.

2.3.2 Power Sources

The J2534 programming device can receive power from both of the following sources:

- Vehicle Power
- AC/DC Power Supply

Vehicle Power

The J2534 programming device operates on 12-volt vehicle power, which it receives through the vehicle data connection port. The device powers on whenever it is connected to an OBD II/EOBD compliant data link connector (DLC). For non OBD II/EOBD compliant vehicles, the device can be powered from a cigarette lighter or other suitable power port on the test vehicle using the auxiliary power cable.

AC/DC Power Supply

The J2534 programming device can be powered from a wall socket using the AC/DC power adapter.

2.3.3 Technical Specifications

Item	Description
Communications	<ul style="list-style-type: none"> • Ethernet: RJ45 Ethernet connection • Bluetooth • USB 2.0
Input Voltage Range	6 VDC to 26 VDC
Supply Current	300 mA @ 6 VDC 200 mA @ 12 VDC 110 mA @ 24 VDC
Operating Temperature	0°C to +60°C (ambient)
Storage Temperature	-65°C to +100°C (ambient)
Dimensions (L x W x H)	183.8mm (7.23") x 135.5mm (5.33") x 41mm (1.6")
Weight	0.54 kg (1.20 lb)

NOTE: For additional information please refer to the accompanied user manual for the J2534 ECU Programming Device.

2.4 Accessory Kit

2.4.1 Main Cable

The VCI device can be powered through the Main Cable when connected to an OBD II/EODB compliant vehicle. The Main Cable connects the VCI device to the vehicle's data link connector (DLC), through which the VCI device can transmit vehicle data to the MaxiSys display tablet.

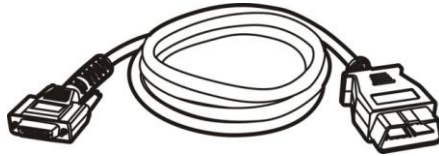

Figure 2-7 Main Cable

Length = 1.9 m for J2534 Programming Device

Length = 1.2 m for Bluetooth Diagnostic Interface

2.4.2 OBD I Adapters

The OBD I adapters are for Non-OBD II vehicles. The adapters used depend on the type of vehicle make being tested. The most common adapters are shown below.



Benz-14



Chrysler-16



BMW-20



Kia-20



Nissan-14

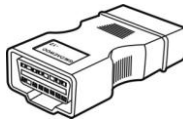

GM/Daewoo-12

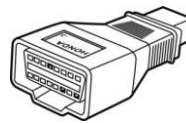

Honda-3

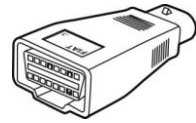

Fiat-3



PSA-2



Benz-38



VW/Audi-2+2



Chang'an-3

Mitsubishi/Hyundai
-12+16

2.4.3 Other Accessories



Standard 2.0 USB Cable

Connects the display tablet to the VCI unit.



Mini USB Cable

Connects the display tablet to the PC.



AC/DC External Power Adapter

Connects the display tablet to the external DC power port for power supply.

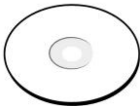

Compact Disc (CD)

Includes the User Manual, Remote Desktop, Printing Services Program and Update Application, etc.



Stylus Pen

Provides precise touch and control, while protecting your touch screen from scratching.



Ethernet Serial Cable

Connects the display tablet to the VCI unit (for J2534 Programming Device only).

**Cigarette Lighter**

Provides power to the display tablet or the J2534 programming device through connection to the vehicle's cigarette lighter receptacle, as some non-OBD II vehicles cannot provide power via the DLC connection.

**Clipper Cable**

Provides power to the display tablet or the J2534 programming device, through connection to the vehicle's battery (for J2534 Programming Device only).

Chapter 3 Getting Started

Make sure the MaxiSys™ Display Tablet has a charged battery or is connected to the DC power supply (see [2.1.2 Power Sources](#) on page 5).

3.1 Powering Up

Press the Power Button on the top right side of the Display Tablet to switch the unit on. The system boots up, and shows the lock screen. Press and drag the inner ring to the edge of the circle to unlock the screen; the MaxiSys Job Menu is shown.



Figure 3-1 Sample MaxiSys Job Menu

1. Application Buttons
2. Locator and Navigation Buttons
3. Status Icons

NOTE: The screen is locked by default when you first turn on the display tablet. It is recommended to lock the screen to protect information in the system and reduce battery usage.









Almost all operations on the display tablet are controlled through the touch screen. The touch screen navigation is menu driven, which allows you to quickly locate the test procedure, or data that you need through a series of choices and questions. Detailed descriptions of the menu structures are found in the chapters for the various applications.





3.1.1 Application Buttons

The Application Buttons configure the MaxiSys for the type of operation or activity to be performed. The table below gives brief descriptions of the available applications.

Use the stylus pen or your finger tip to select an application from the Job Menu.

Table 3-1 *Applications*





Name	Button	Description
Diagnostics		Configures the unit to operate as a diagnostic tool. See Diagnostics Operations on page 20.
Data Manager		Opens the organization system for saved data files. See Data Manager Operations on page 57.
MaxiCloud		Launches the MaxiCloud platform which provides the most compatible and abundant repair techniques and diagnostics database. See MaxiCloud Operations on page 62.
Settings		Allows you to set the system settings, and to view the general information about the Display Tablet. See Settings Operations on page 70.
Shop Manager		Allows you to edit and save workshop information and customer data, as well as reviewing test vehicle history records. See Shop Manager Operations on page 74.
Update		Checks for latest update available for the system, and perform updating procedures. See Update Operation on page 82.
VCI Manager		Establishes and manages Bluetooth or wired connections to the VCI device. See VCI Manager Operations on page 84.
Remote Desk		Configures your unit to receive remote support using the TeamViewer application program. See Remote Desk Operations on page 88.
Support		Launches the Support platform which synchronizes Autel's on-line service base station with the MaxiSys tablet. See Support Operations on page 90.







Name	Button	Description
Remote Program		Configures your unit to operate as a PassThru interface to allow remote control for vehicle diagnosis and ECU reprogramming. See Remote Program Operations (Coming soon) on page 99.
Training		Allows you to store and play useful technical tutorial videos for the device usage or vehicle repair and maintenance techniques, etc. See Training Operations on page 99.
Quick Link		Provides associated website bookmarks to allow quick access for product update, service, support and other information. See Quick Link Operations on page 101.
Digital Inspection		Configures the unit to operate as a video scope device by connecting to an Imager head cable for close vehicle inspections. See Digital Inspection Operations on page 102.
Scope		Configures the unit to operate as a lab scope, graphing multimeter, or digital multimeter. See Scope Operations (Coming soon) on page 107.

3.1.2 Locator and Navigation Buttons

Operations of the Navigation Buttons at the bottom of the screen are described in the table below:

Table 3-2 *Locator and Navigation Buttons*

Name	Button	Description
Locator		Indicates the location of the screen. Swipe the screen left or right to view the previous or next screen.
Back		Returns to the previous screen.
Home		Returns to Android System's Home screen.
Recent Apps		Displays a list of applications that are currently working. To open an app, touch it. To remove an app, swipe it to the right.

Name	Button	Description
Chrome		Launches the Chrome browser.
Camera		Opens the camera.
Display & Sound		Allows you to adjust the brightness of the screen and the volume of the audio output.
VCI Manager	 	Opens the VCI Manager application. The tick icon at the bottom right corner indicates the display tablet is communicating with the VCI device, otherwise a cross icon displays.
MaxiSys Shortcut		Returns to the MaxiSys Job Menu or diagnostic interface.

➤ **To use the camera:**

1. Tap the **Camera** button. The camera screen opens.
2. Focus the image to be captured in the view finder.
3. Tap the blue circle. The view finder now shows the captured picture and auto-saves the taken photo.
4. Tap the thumbnail image on the top right corner of the screen to view the stored images.
5. Tap the **Back** or **Home** button to exit the camera application.

Refer to Android documentation for additional information.

3.1.3 System Status Icons

These are the standard status icons of the Android Operating system. Your MaxiSys display tablet is a fully functional Android Pad. Refer to Android documentation for additional information.

3.2 Powering Down

All vehicle communication must be terminated before shutting down the MaxiSys display tablet. A warning message displays if you attempt to shut down while the VCI unit is communicating with the vehicle. Forcing a shut down while communicating may lead to ECM problems on some vehicles. Exit the Diagnostic application before powering down.

- **To power down the MaxiSys tablet:**
 1. Press and hold the Lock/Power Button.
 2. Tap **OK**; the tablet will turn off in a few seconds.

3.2.1 Reboot System

In case of system crash, press and hold the Lock/Power button for 8 seconds to reboot the system.

3.3 Install Computer Software

The MaxiSys™ diagnostic device allows you to realize some of its functions on a computer to enhance capabilities and improve user experience. To realize these functions on a computer, you need to install certain software.

There are two Setup.exe program packages contained in the CD provided with the MaxiSys tool kit. The packages include the following applications:

1. Remote Control – launches a remote control application which allows you to take a view or control of the MaxiSys tablet remotely from the computer via the Internet connection
2. PC Link – launches a printer interface which receives and allows editing the files sent from the MaxiSys tablet for printing
3. Setup Driver for the VCI device
4. Firmware Update Agent for the VCI device

- **To install the Setup.exe program**

1. Insert the CD into the CD-ROM of the computer. The driver installation wizard will load momentarily.
2. Click on **Next** on the welcome page.
3. Click the **Change** button, and select a destination folder to install the program, and click **Next** to continue. Or directly click **Next** to continue without changing the default installation folder.
4. Click **Install** and the Setup.exe program will be installed onto the computer.

3.3.1 Printing Operation

This section describes how to receive file from the MaxiSys tablet and perform printing through the computer:

➤ **To perform printing through the computer**

1. Install the PC Link (the printer interface program) to the computer.
2. Make sure the display tablet is connected to the computer network, either via Wi-Fi or LAN, before printing. See [7.1.3 Printing Setting](#) on page 71 for more information.
3. Run the printer interface program on the computer.
4. Tap the **Print** button on the toolbar displayed in various applications on the MaxiSys display tablet. A temporary file will be created and send to the computer for printing.
5. Click the **Printer Server** tab on the top of the printer interface, and wait for the printing file to load.
6. Click the **Print** button on the printer interface to start printing.

NOTE: Make sure the computer installed with the printer interface program is connected to a printer.

Chapter 4 Diagnostics Operations

By establishing a data link to the electronic control systems of the vehicle being serviced through the VCI device, the Diagnostics application allows you to retrieve diagnostic information, view live data parameters, and perform active tests. The Diagnostics application can access the electronic control module (ECM) for various vehicle control systems, such as engine, transmission, antilock brake system (ABS), airbag system (SRS) and more.

4.1 Vehicle Connection

The Diagnostics operations require connecting the MaxiSys™ Diagnostic Platform to the test vehicle using the main cable, and test adapters (for non-OBD II vehicles). The method used to connect the VCI device to a vehicle's DLC depends on the vehicle's configuration as follows:

- A vehicle equipped with an On-Board Diagnostics Two (OBD II) management system supplies both communication and 12-volt power through a standardized J-1962 DLC.
- A vehicle not equipped with an OBD II management system supplies communication through a DLC connection, and in some cases supplies 12-volt power through the cigarette lighter receptacle or a connection to the vehicle battery.

OBD II Vehicle Connection

This type of connection only requires the main cable without any additional adapter.

➤ **To connect to an OBD II vehicle**

1. Connect the main cable's female adapter to the Vehicle Data Connector on the VCI device, and tighten the captive screws.
2. Connect the cable's 16-pin male adapter to the vehicle's DLC, which is generally located under the vehicle dash.

NOTE: The vehicle's DLC is not always located under the dash; refer to the user manual of the test vehicle for additional connection information.

Non-OBD II Vehicle Connection

This type of connection requires both the main cable and a required OBD I adapter for the specific vehicle being serviced.

There are three possible conditions for Non-OBD II vehicle connection:

- DLC connection supplies both communication and power.
- DLC connection supplies communication and power is to be supplied via the cigarette lighter connection.
- DLC connection supplies communication and power is to be supplied via connection to the vehicle battery.

➤ **To connect to a Non-OBD II Vehicle**

1. Locate the required OBD I adapter and connect its 16-pin jack to the main cable's male adapter.
2. Connect the main cable's female adapter to the Vehicle Data Connector on the VCI device, and tighten the captive screws.
3. Connect the attached OBD I adapter to the vehicle's DLC.

NOTE: Some adapters may have more than one adapter or may have test leads instead of an adapter. Whatever the case, make the proper connection to the vehicle's DLC as required.

➤ **To connect the cigarette lighter - for J2534 ECU Programming Device only**

1. Plug the DC power connector of the cigarette lighter into the J2534 programming device.
2. Connect the male connector of the cigarette lighter into the vehicle's cigarette lighter receptacle.

➤ **To connect the clipper cable - for J2534 ECU Programming Device only**

1. Connects the tubular plug of the clipper cable to the male connector of the cigarette lighter.

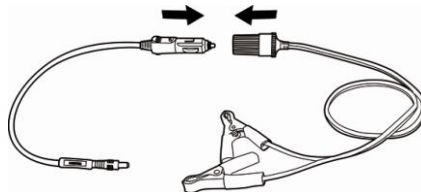

Figure 4-1 Connection between Cigarette Lighter and Clipper Cable

2. Plug the DC power connector of the cigarette lighter into the J2534 programming device.
3. Connect the clipper cable to the vehicle's battery.

4.1.1 No Communication Message

- A. If the MaxiSys Display Tablet is not connected to the VCI device, an "Error" message displays. An "Error" message indicates the display tablet is not communicating with the VCI device, and so cannot gain access to the vehicle control module. In this case, you need to do the following check-ups:
 - Check if the VCI device is powered on.
 - Check the cable connection between the display tablet and the VCI device.
 - In case of wireless connection, check that the network is configured correctly.
- B. If the VCI device is unable to establish a communication link, a prompt message displays with check instructions. The following conditions are the possible causes for this message to display:
 - The VCI device is unable to establish a communication link with the vehicle.
 - You've selected a system for testing that the vehicle is not equipped with.
 - There is a loose connection.
 - There is a blown vehicle fuse.
 - There is a wiring fault on the vehicle, or the data cable or adapter.
 - There is a circuit fault in the data cable or adapter.
 - Incorrect vehicle identification was entered.

4.2 Getting Started

Prior to first use of the Diagnostics application, the VCI device must be synchronized with the MaxiSys Display Tablet to establish a communication link. See [VCI Manager Operations](#) on page 84.

4.2.1 Vehicle Menu Layout

When the VCI device is properly connected to the vehicle, and paired to the MaxiSys Display Tablet, the platform is ready to start vehicle diagnosis. Tap on the Diagnostics application button on the MaxiSys Job Menu, the screen then opens the Vehicle Menu.



Figure 4-2 Sample Vehicle Menu Screen







1. Top Toolbar Buttons
2. Manufacturers Buttons

Top toolbar Buttons

The operations of the Toolbar buttons at the top of the screen are listed and described in the table below:

Table 4-1 Top Toolbar Buttons

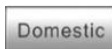
Name	Button	Description
Home		Returns to the MaxiSys Job Menu.
VIN Scan		Touching this button opens a dropdown list; Tap Auto Detect for auto VIN detection; tap Manual Input to enter VIN manually.
All		Displays all the vehicle makes in the vehicle menu.

Name	Button	Description
History		Displays the stored test vehicle history records. This option provides you direct access to the previously tested vehicle, recorded during previous test sessions. See 8.1 Vehicle History on page 74.
USA		Displays the USA vehicle menu.
Europe		Displays the European vehicle menu.
Asia		Displays the Asian vehicle menu.
Domestic		Displays the Domestic vehicle menu.
Search		Touching this button opens the virtual keyboard, allowing you to manually enter the specific vehicle make required.
Cancel		Touching this button exits the search screen, or cancels an operation.

Manufacturers Buttons

The Manufacturer Buttons shows the various vehicle logos and the brand names. Select the required manufacturer button after the VCI device is properly connected to the test vehicle to start a diagnostic session.

The small envelop icon displays beside the vehicle brand name is tappable, touching which displays an attached PDF file, showing relevant information, such as vehicle coverage and function list etc for the corresponding vehicle make.

4.3 Vehicle Identification

The Maxisys diagnostic system supports four methods for Vehicle Identification.

1. Auto VIN Scan
2. Manual VIN Input
3. Manual Vehicle Selection

4.3.1 Auto VIN Scan

The MaxiSys diagnostics system features the latest VIN-based Auto VIN Scan function to identify CAN vehicles in just one touch, which allows the technician to quickly detect vehicles, scan all the diagnosable ECUs on every vehicle and run diagnostics on the selected system.

➤ **To perform Auto VIN Scan**

1. Tap the **Diagnostics** application button from the MaxiSys Job Menu. The Vehicle Menu displays. (*Figure 4-2*)
2. Tap the **VIN Scan** button on the top toolbar.
3. Select **Auto Detect**. The tester starts VIN scanning on the vehicle's ECU, once the test vehicle is successfully identified, the system will guide you to the Vehicle Diagnostics screen directly.

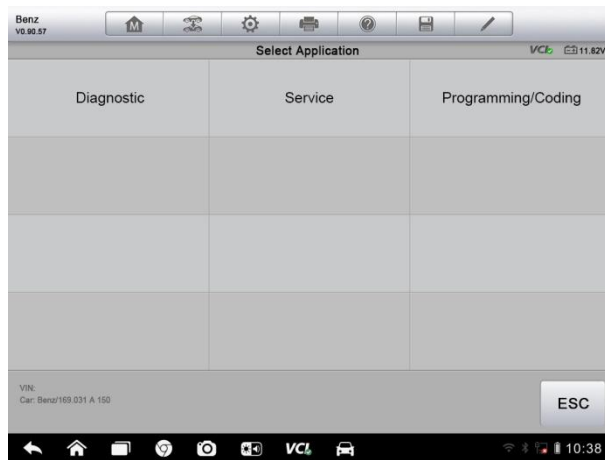

Figure 4-3 Sample Vehicle Diagnostics Screen

4.3.2 Manual VIN Input

For some vehicles that do not support the Auto VIN Scan function, the MaxiSys diagnostic system allows you to enter the vehicle VIN manually, or simply take a photo of the VIN sticker for quick vehicle identification.

- **To perform Manual VIN Input**
 1. Tap the **Diagnostics** application button from the MaxiSys Job Menu. The Vehicle Menu displays. (*Figure 4-2*)
 2. Tap the **VIN Scan** button on the top toolbar.
 3. Select **Manual Input**.
 4. Tap the input box and enter the correct VIN.

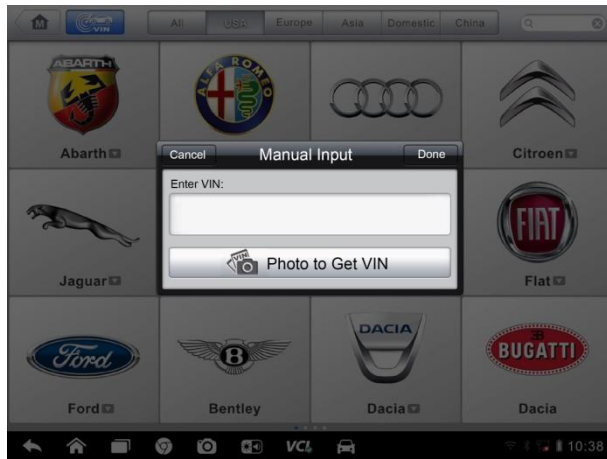

Figure 4-4 Manual VIN Input

5. Tap **Done**. The vehicle will be identified in a few seconds, and once the matching is successful, the system will guide you to the Vehicle Diagnostics screen directly. (*Figure 4-3*)
6. Tap **Cancel** to exit Manual Input.

4.3.3 Manual Vehicle Selection

When the vehicle's VIN is not automatically retrievable through the vehicle's ECU, or the specific VIN is unknown, you can choose to select the vehicle manually.

There are generally three ways to enter the vehicle information:

A. Step-by-step Vehicle Selection

This mode of vehicle selection is menu driven; you simply follow the screen prompts and make a series of choices. Each selection you make advances you to the next screen. A **Back** button at the lower right corner of the screen returns you to the previous screen. Exact procedures may vary somewhat by various vehicles being serviced.

B. Manual Vehicle Entry

This mode allows you to manually enter and save specific vehicle information, such as PCM Part Number, Vehicle Calibration Number Tear Tag, or VIN number. This function enables direct access to the vehicle's ECM and saves your time of doing step-by-step entry selections.

- **To perform Manual Vehicle Entry - take Ford for example**
1. Tap the **Diagnostics** application button from the MaxiSys Job Menu. The Vehicle Menu displays. (*Figure 4-2*)
 2. Tap the **USA** or the **All** button on the top toolbar.
 3. Select the **Ford** button from the vehicle menu.
 4. Select **Manual Vehicle Entry** from the Vehicle Selection Menu. (*Figure 4-5*) A series of information screen displays, tap **Yes** to continue.

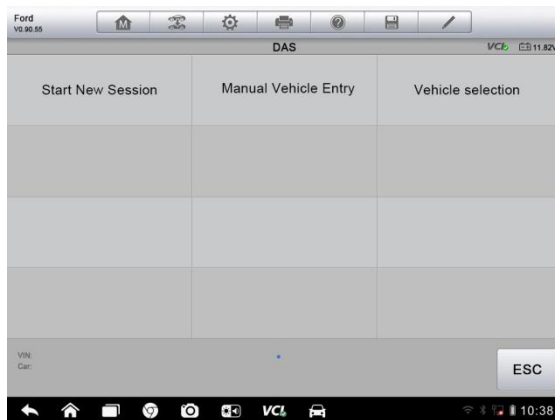

Figure 4-5 Sample Vehicle Selection Menu

5. Select one of the three entries in the option screen - **PCM Part Number**, **Calibration Number** or **Tear Tag**.
6. Take the **PCM Part Number** entry for example; you need to fill up the accurate vehicle information in the input boxes.



Figure 4-6 *PCM Part Number Input Screen*

7. Tap **OK** to continue when the input is done. A confirming screen showing the Vehicle Information displays.
8. Check if the vehicle information is correct, and then from the confirming screen, select:
 - a) **Yes** to continue.
 - b) **No** to return to the vehicle selection menu.
9. Select Yes and the vehicle diagnostics screen displays. (*Figure 4-3*)

C. Auto Vehicle Entry

Some vehicles provide an auto scan feature, which allows you to skip the step-by-step vehicle identification procedure and retrieve the specific vehicle information from the vehicle's ECU directly.

- **To perform Auto Vehicle Entry - take Ford for example**
 1. Tap the **Diagnostics** application button from the MaxiSys Job Menu. The Vehicle Menu displays. (*Figure 4-2*)
 2. Tap the **USA** or the **All** button on the top toolbar.
 3. Select the **Ford** button from the vehicle menu.
 4. Select **Start New Session** from the vehicle selection menu. A confirming screen showing the Vehicle Information displays.
 5. Check if the vehicle information is correct, and then from the confirming screen, select:
 - a) **Yes** to continue.
 - b) **No** to return to the vehicle selection menu.
 6. Select **Yes** and the vehicle diagnostics screen displays. (*Figure 4-3*)

4.3.4 Alternative Vehicle Identification

Occasionally, you may identify a test vehicle that the tester does not recognize; the database does not support, or has some unique characteristics that prevent it from communicating with the tester through the normal channels. In these instances, you are provided with the OBD direct entry, through which you can perform generic OBD-II or EOBD tests. See [4.6 Generic OBD II Operations](#) on page 51 for additional information.

4.4 Navigation

This section describes how to navigate the Diagnostics interface and select test options.

4.4.1 Diagnostics Screen Layout

The diagnostics screens typically include four sections. (*Figure 4-7*)

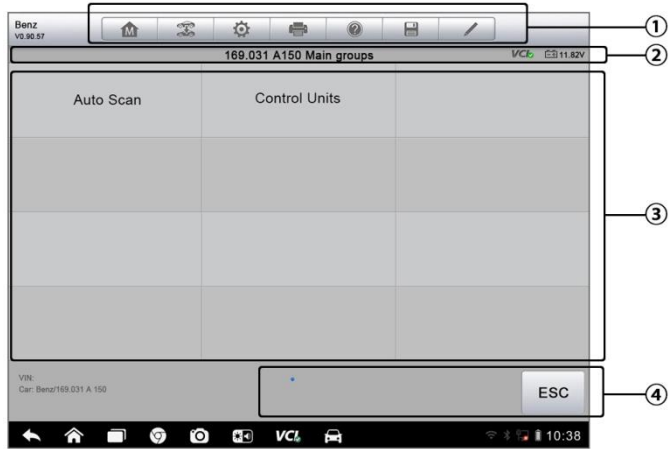

Figure 4-7 Sample Diagnostics Screen





1. Diagnostics Toolbar
2. Status Information Bar
3. Main Section
4. Functional Buttons

Diagnostics Toolbar

The Diagnostics toolbar contains a number of buttons that allow you to print or save the displayed data and make other controls. The table below provides a brief description of the Diagnostics toolbar button operations:

Table 4-2 Diagnostics Toolbar Buttons

Name	Button	Description
Home		Returns to the MaxiSys Job Menu.
Vehicle Swap		Touching this button allows you to exit the diagnostic session of the currently identified test vehicle, and returns you to the vehicle menu screen to select another vehicle for testing.
Settings		Opens the setting screen. See Settings Operations on page 70.

Name	Button	Description
Print		Saves and prints a copy of the displayed data. See 3.3.1 Printing Operation for additional information on page 19.
Help		Provides instructions for operations of various diagnostic functions.
Save		<p>Tapping this button opens a submenu, on which there are 3 options available to save the displayed data.</p> <ul style="list-style-type: none"> • Tap Save This Page to take a screenshot image • Tap Save All Data to save a PDF file (mostly used to save data that cover more than 1 page) • Tap Start Saving to record a video clip (only available for recording Live Data or special graph data) <p>All saved data are stored in the Data Manager application for later reviews. See Data Manager Operations on page 57.</p>
Data Logging		Records the communication data and ECU information of the test vehicle. The saved data can be reported and sent to the technical center via the internet.

➤ **To perform data printing in Diagnostics**

1. Tap the **Diagnostics** application button from the MaxiSys Job Menu. The **Print** button on the diagnostic toolbar is available throughout the whole Diagnostics operations.
2. Tap **Print** whenever you want to make a printing. A drop-down menu appears.
 - a) **Print This Page** – prints a screenshot copy of the current screen
 - b) **Print All Page** – prints a PDF copy of all displayed data
3. A temporary file will be created and send to the computer for printing.
4. When the file is transferred successfully, a confirmation message displays.

NOTE: Make sure the display tablet is connected to the computer network, either via Wi-Fi or LAN, before printing. For more instructions on printing, see [3.3.1 Printing Operation](#) on page 19 for detailed information.

Status Information Bar

The Status Information Bar at the top of the Main Section displays the following items:

1. **Menu Title** – indicates the menu subject of the Main Section
2. **VCI Icon** – indicates the communication status between the tablet and the VCI device
3. **Battery Icon** – indicates the battery status of the vehicle

Main Section

The Main Section of the screen varies depending on the stage of operations. The main section can show vehicle identification selections, the main menu, test data, messages, instructions and other diagnostic information.

Functional Buttons

The displayed Functional Buttons at this section of the screen varies depending on the stage of operations. They can be used to navigate, save or clear the diagnostic data, exit scanning as well as make other functional controls. The functions of these buttons will be introduced respectively in the following sections of the corresponding test operations.

4.4.2 Screen Messages

Screen messages appear when additional input is needed before proceeding. There are mainly three types of on-screen messages as to their purposes: confirmation, warning, and error.

Confirmation Messages

This type of messages usually displays as an “Information” screen, which informs you when you are about to perform an action that cannot be reversed or when an action has been initiated and your confirmation is needed to continue.

When a user-response is not required to continue, the message displays briefly before automatically disappearing.

Warning Messages

This type of messages informs you when completing the selected action may result in an irreversible change or loss of data. The typical example for this is the “Erase Codes” message.

Error Messages

Error messages inform you when a system or procedural error has occurred. Examples of possible errors include a disconnected cable or communication interruption due to certain reasons.

4.4.3 Making Selections

The Diagnostics application is a menu driven program that presents a series of choices one at a time. As you select from a menu, the next menu in the series displays. Each selection narrows the focus and leads to the desired test. Use your fingertip or the stylus pen to make menu selections

4.5 Operations

The Diagnostics application allows you to establish a data link to the electronic control system of the test vehicle via the VCI device for vehicle diagnosis, service or programming. You can use functional tests, retrieve vehicle diagnostic information such as trouble codes, event codes and live data, and perform ECU reprogramming, for various vehicle control systems, such as engine, transmission, ABS and more.

The Vehicle Diagnostics screen (*Figure 4-3*) has three main options:

1. **Diagnosis** – a comprehensive section which includes all available functions: reading, clearing, saving and printing diagnostic information, as well as performing active tests and ECU reprogramming
2. **Service** – a separate section designed for quick access to functional and active test operations
3. **Programming/Coding** – a separate section designed for quick access to ECU reprogramming operations

After a section is selected and the tablet establishes communication with the vehicle via the VCI device, a selection menu of the available control units or systems displays.

4.5.1 Diagnosis

There are two options available when accessing the Diagnosis section:

1. **Auto Scan** – starts auto scanning for all the available systems on the vehicle
2. **Control Units** – displays a selection menu of all available control units of the test vehicle

Auto Scan

The Auto Scan function performs a comprehensive scanning over all the systems on the vehicle's ECU in order to locate fault systems and retrieve DTCs. The sample operation interface of Auto Scan displays as below:

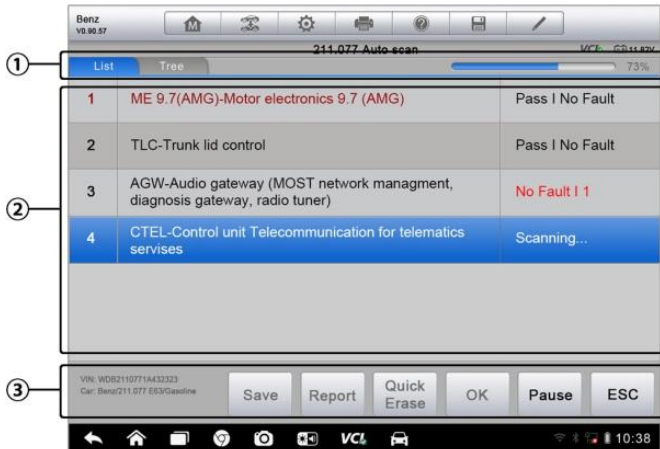

Figure 4-8 Sample Auto Scan Operation Screen

1. Navigation Bar
 2. Main Section
 3. Functional Buttons
- **Navigation Bar**
 1. List Tab – displays the scanned data in list format
 2. Tree Tab – display the scanned data in system distribution diagram format
 3. Progress Bar – indicates the test progress

- **Main Section**

- A. List Tab

- Column 1 - displays the system numbers

- Column 2 - displays the scanned systems

- Column 3 - displays the diagnostic marks indicating different conditions of the test result:

- !-: Indicates that the scanned system may not support the code reading function, or there is a communication error between the tester and the control system.

- ?-: Indicates that the vehicle control system has been detected, but the tester cannot accurately locate it.

- Fault | #:** Indicates there is/are detected fault code(s) present; “#” indicates the number of detected faults.

- Pass | No Fault:** Indicates the system has been scanned and no fault has been detected.

- B. Tree Tab

- The tree tab screen displays a system distribution diagram of the vehicle control modules. The scanned system which has passed scanning with no fault is shown in blue font; whereas the scanned system that has been detected with fault present is shown in red font.

- Tab the  button to the right of the system item, on which you want to perform further diagnosis and other test activities. A function screen shall then display.

- **Functional Buttons**

- The table below provides a brief description of the Functional Buttons' operations in Auto Scan:

Table 4-3 *Functional Buttons in Auto Scan*

Name	Description
Back	Returns to the previous screen or exit Auto Scan.
Pause	Suspends scanning and changes to show the Continue button.
OK	Confirms the test result, and continues to the system diagnosis after selecting the required system by tapping the item in the Main Section.
Quick Erase	Deletes codes. A warning message screen will display to inform you of possible data loss when this function is selected.
Report	Displays the diagnostic data in report form.
Save	Saves the diagnostic session as a history record, this allows you to quickly restore access to the test systems.

Control Units

This option allows you to manually locate a required control system for testing through a series of choices. You simply follow the menu driven procedure, and make proper selection each time; the program will guides you to the diagnostic function menu after a few choices you’ve made.

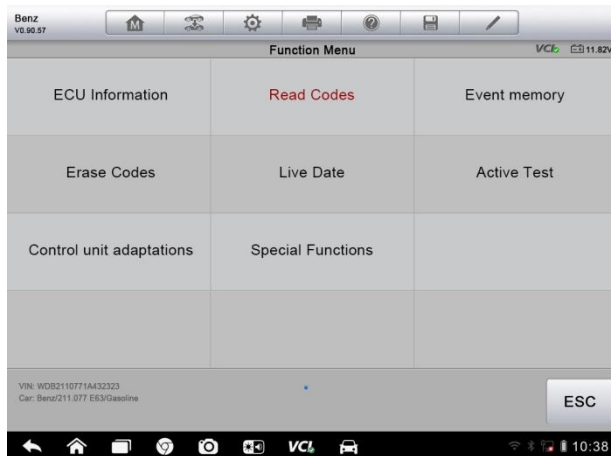

Figure 4-9 *Sample Function Menu Screen*

The Function Menu options vary slightly by different vehicles. The function menu may include:

- **ECU Information** – provides the retrieved ECU information in detail. Selecting opens an information screen.
- **Read Codes** – displays detailed information of DTC records from the vehicle control module.
- **Erase Codes** – erases DTC records and other data from the ECM.
- **Live Data** – retrieves and displays live data and parameters from the vehicle's ECU.
- **Active Test** – provides specific subsystem and component tests. This selection may appear as **Actuators**, **Actuator Test**, or **Function Tests**, etc., and the tests options vary depending on the manufacturer and model.
- **Programming/Coding** – provides ECU reprogramming or variant coding functions for custom configurations, and also allows you to reprogram adaptive values for certain components after making repairs. Depending on the test vehicle, this selection may sometimes appear as **Control Unit Adaptations**, **Special Functions**, **Variant Coding**, **Configuration** or something similar.

NOTE: With the diagnostic toolbar on top of the screen throughout the whole diagnostic procedures, you are allowed to make various controls of the diagnostic information at anytime, such as printing and saving the displayed data, get help information, or perform data logging, etc.

➤ **To perform a diagnostic function**

1. Establish communication with the test vehicle via the VCI device.
2. Identify the test vehicle by selecting from the menu options.
3. Locate the required system for testing by Auto Scan or through menu driven selections in Control Units.
4. Select the desired test from the Function Menu.

4.5.2 ECU Information

This function retrieves and displays the specific information for the tested control unit, including unit type, version numbers and other specifications. The sample ECU Information screen displays as below:

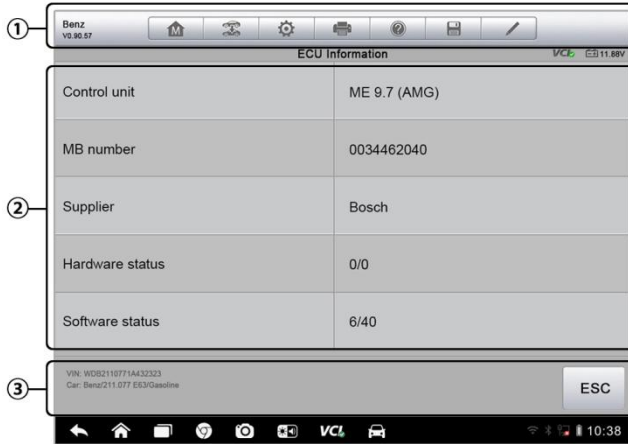

Figure 4-10 Sample ECU Information Screen

1. **Diagnostics Toolbar Buttons** – see [Table 4-2 Diagnostics Toolbar Buttons](#) on page 30 for detailed descriptions of the operations for each button.
2. **Main Section** – the left column displays the item names; the right column shows the specifications or descriptions.
3. **Functional Button** – In this case, only a Back (or sometimes an ESC) button is available; tap it to exit after viewing.

4.5.3 Read Codes

This function retrieves and displays the DTCs from the vehicle's control system. The Read Codes screen varies for each vehicle being tested, on some vehicles, freeze frame data can also be retrieved for viewing. The sample Read Codes screen displays as below:

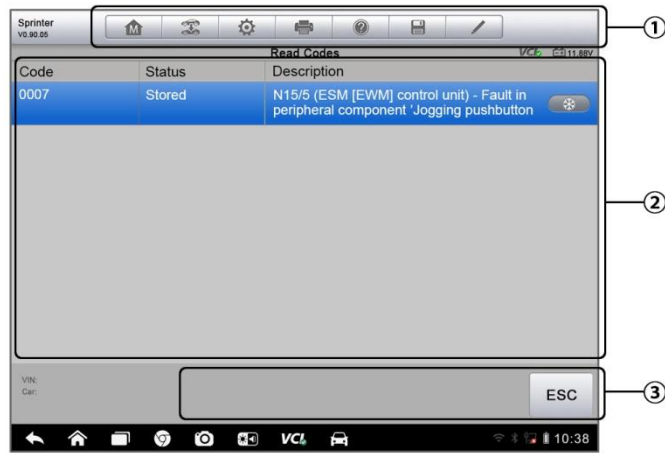

Figure 4-11 Sample Read Codes Screen

1. **Diagnostics Toolbar Buttons** – see [Table 4-2 Diagnostics Toolbar Buttons](#) on page 30 for detailed descriptions of the operations for each button.
2. **Main Section**
 - Code Column – displays the retrieved codes from the vehicle.
 - Status Column – indicates the status of the retrieved codes.
 - Description Column – detailed descriptions for the retrieved codes.
 - Snowflake Icon – only displays when freeze frame data is available for viewing; Selecting displays a data screen, which looks very similar to the Read Codes interface, therefore same operation method may be applied.
3. **Functional Button** – In this case, only a Back (or sometimes an ESC) button is available; tap it to return to the previous screen or exit the function.

4.5.4 Erase Codes

After reading the retrieved codes from the vehicle and certain repairs have been carried out, you can decide to erase the codes from the vehicle using this function. Before performing this function, make sure the vehicle's ignition key is in the ON (RUN) position with the engine off.

➤ **To erase codes**

1. Tap **Erase Codes** from the Function Menu.
2. A warning message displays to inform you of data loss when this function is applied.
 - a) Tap **Yes** to continue. A confirming screen displays when the operation is successfully done.
 - b) Tap **No** to exit.
3. Tap **ESC** on the confirming screen to exit Erase Codes.
4. Check the Read Codes function again to ensure the operation is successful.

4.5.5 Live Data

When this function is selected, the screen displays the data list for the selected module. The items available for any control module vary from one vehicle to another. The parameters display in the order that they are transmitted by the ECM, so expect variation between vehicles.

Gesture scrolling allows you to quickly move through the data list. Simply touch the screen and drag your finger up or down to reposition the parameters being displayed, if the data covers more than one screen. The figure below shows a typical Live Data screen:

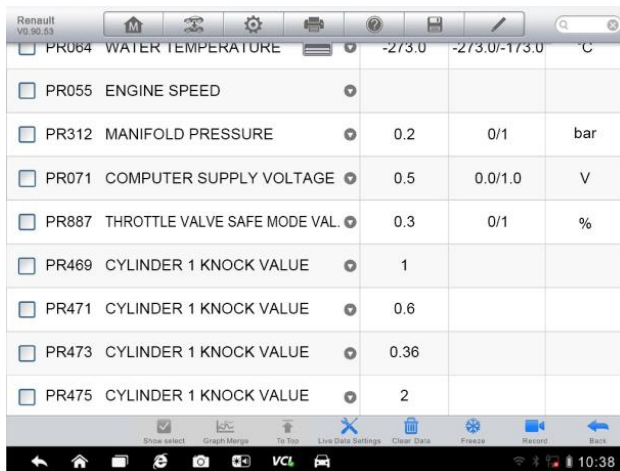

Parameter ID	Parameter Name	Value	Unit
PR064	WATER TEMPERATURE	-2/3.0	-2/3.0/-17/3.0 C
PR055	ENGINE SPEED		
PR312	MANIFOLD PRESSURE	0.2	0/1 bar
PR071	COMPUTER SUPPLY VOLTAGE	0.5	0.0/1.0 V
PR887	THROTTLE VALVE SAFE MODE VAL.	0.3	0/1 %
PR469	CYLINDER 1 KNOCK VALUE	1	
PR471	CYLINDER 1 KNOCK VALUE	0.6	
PR473	CYLINDER 1 KNOCK VALUE	0.36	
PR475	CYLINDER 1 KNOCK VALUE	2	

Figure 4-12 Sample Live Data Screen

1. **Diagnostics Toolbar Buttons** – tap the drop-down button at the top center of the screen displays the toolbar buttons. See [Table 4-2 Diagnostics Toolbar Buttons](#) on page 30 for detailed descriptions of the operations for each button.
2. **Main Section**
 - Name Column – this column displays the parameter names.
 - a) **Check Box** - tap the check box at the left side of the parameter name to make selection of an item. Tap the check box again to deselect the item.
 - b) **Drop-down Button** – tapping the drop-down button at the right side of the parameter name opens a submenu, which provides various choices for data display mode.
 - Value Column – displays the values of the parameter items.
 - Range Column - displays the minimum and the maximum limit value.
 - Unit Column – displays the unit for the parameter values.
 - To change the unit mode, tap the **Setting** button on the top toolbar and select a required mode. See [7.1.1 Unit](#) on page 70 for more information.
3. **Display Mode**

There are 4 types of display modes available for data viewing, allowing you to view various types of parameters in the most suitable way for better data check-ups.

Tapping the drop-down button on the right side of the parameter name opens a submenu. There are 4 buttons to configure the data display mode, plus one Help button on the right, tappable when additional information is available for your reference.

Each parameter item displays the selected mode independently.

Analog Gauge Mode – displays the parameters in form of an analog meter graph

Text Mode – this is the default mode which displays the parameters in texts and shows in list format

NOTE: Reading of status parameters, such as a switch reading, which are mostly in word form, like ON, OFF, ACTIVE, and ABORT, etc., can only be displayed in Text Mode. Whereas reading of value parameters, such as a sensor reading, can be displayed in text mode and other graph modes.

Waveform Graph Mode – displays the parameters in waveform graphs

When displaying this mode, three control buttons will appear on the right side of the parameter item to manipulate the display status.

- **Text Button** – resumes Text Display Mode
- **Scale Button** – changes the scale values, which are displayed below the waveform graph. There are four scales available: x1, x2, x4 and x8.
- **Zoom-in Button** – tap once to display the selected data graph in full screen

Digital Gauge Mode– displays the parameters in form of a digital gauge graph

Full Screen Display – this option is only available in the waveform graph mode, and mostly used in Graph Merge status for data comparison. There are three control buttons available on the top right side of the screen under this mode.

- **Edit Button** – tapping this button opens an edit window, on which you can set the waveform color and the line thickness for the selected parameter item.
- **Scale Button** - changes the scale values, which are displayed below the waveform graph. There are 4 scales available: x1, x2, x4 and x8.
- **Zoom-out Button** – exits full screen display.

➤ **To edit the waveform color and line thickness in a data graph**

1. Select 1 - 3 parameter items to display in Waveform Graph mode.
2. Tap the **Zoom-in Button** on the right to display the data graph in full screen.
3. Tap the **Edit Button**, an edit window appears.
4. Select a parameter item on the left column.
5. Select a desired sample color from the second column.
6. Select a desired sample line thickness from the right column.
7. Repeat step 4-7 to edit the waveform display for each parameter item.
8. Tap **Done** to save the setting and exit, or tap **Cancel** to exit without saving.

4. Functional Buttons

The operations of all the available functional buttons on Live Data screen are described below:

Back – returns you to the previous screen or exit the function.

Record – starts recording the retrieved live data; the recorded data is then stored as a video clip in the Data Manager application for future reviews. This function could be triggered automatically at preset threshold value or manually as you choose, and the triggering mode and record duration can be configured in the Setting function.

Freeze – displays the retrieved data in freeze mode.

- Previous Frame – Moves to the previous frame in the freeze data.
- Next Frame – Moves to the next frame in the freeze data.

Resume – this button appears when the Record or Freeze function is applied. Tapping this button stops data recording, or exit freeze data mode, and resumes normal data display mode.

Flag – this button appears when the Record function is applied. Tapping this button sets flags for the recorded data at points wherever you choose, when playing back the recorded video clip later in Data Manager, the preset flag will enable a popup to allow input of text for notes.

Clear Data –tapping which clears all previously retrieved parameter values at a cutting point whenever you choose.

To Top – moves a selected data item to the top of the list.

Graph Merge – tap this button to merge selected data graphs (for Waveform Graph Mode only). This function is very useful when making comparison for different parameters.

NOTE: This mode supports Graph Merge for 2 to 3 parameter items only, so select no less than 2 or more than 3 items each time when making graph merge.

- To cancel Graph Merge mode, tap the drop-down button on the right side of the parameter name, and select a data display mode.

Show Selected/Show All – tap this option to exchange between the two options; one displays the selected parameter items, the other displays all the available items.

Setting – tapping this button opens a setting screen, which allows you to set the trigger mode, recording duration, and various threshold values for data recording, and make other controls.



Figure 4-13 *Sample Setting Screen in Live Data*

There are four navigation buttons on top of the Setting screen.



- **Range Button** – displays the configuration screen on which you can set the threshold values, an upper limit and a lower limit, for triggering the buzzer alarm. This function is only applied to the Waveform Graph display mode.
 - a) **MIN** – tapping which opens a virtual keyboard, allows you to enter the required lower limit value
 - b) **MAX** – tapping which opens a virtual keyboard, allows you to enter the required upper limit value
 - c) **Buzzer Alarm** – switches the alarm on and off. The alarm function makes a beep sound as a reminder whenever the data reading reaches the minimum or maximum point

➤ **To set threshold limits for the parameter values**

1. Tap the **Setting** functional button at the bottom of the Live Data screen.
2. Tap the **Range** navigation button.
3. Select a parameter item on the left column, or enter the item name in the Search bar.
4. Tap on the right side of the **MIN** button, and enter the required minimum value.
5. Tap on the right side of the **MAX** button, and enter the required maximum value.
6. Tap the **ON/OFF** button on the right side of the Buzzer Alarm button to turn it on or off.
7. Tap **Done** to save the setting and return to the Live Data screen; or tap **Cancel** to exit without saving.

If the threshold limits are successfully set, two horizontal lines now appear on each of the data graphs (when Waveform Graph Mode is applied) to indicate the alarming point. The threshold lines are shown in different colors than the waveform of the parameters for distinction.

- **Record Button** – displays the configuration screen for Record Setting, on which you can set the trigger type, duration and trigger point for the data recording function.
 - a) **Trigger Type** – sets the trigger mode for data recording, mainly of two kinds: Manual and Auto. There are four options available:
 - 1) **Manual** – allows you to manually start and stop data recording
 - 2) **DTC** – auto triggers data recording when any DTC is detected
 - 3) **DTC Check Mode** – auto triggers data recording when certain pre-selected DTC types are detected
 - 4) **Parameter** – auto triggers data recording when any parameter value reaches the preset threshold
 - b) **Duration** – sets the recording time (for Auto trigger mode only)
 - c) **Trigger Point** – sets aside a relative percentage of a record length before the data recording start point (for Auto trigger mode only)

- **To perform setting for live data record**
 1. Tap the **Setting** functional button at the bottom of the Live Data screen.
 2. Tap the **Record** navigation button.
 3. Tap the  button on the right of **Trigger Type** bar and select the required trigger mode.
 4. Tap the  button on the right of **Duration** bar and select a length of time.
 5. Tap the  button on the right of **Trigger Point** bar and select a relative percentage of a record length to be set aside before the data recording start point.
 6. Tap **Done** to save the setting and return to the Live Data screen; or tap **Cancel** to cancel without saving and exit Setting.
- **Done Button** - confirms and saves the setting, and returns you to the Live Data screen.
- **Cancel Button** – cancel the setting operation, and returns you to the Live Data screen.

4.5.6 Active Test

The Active Test function is used to access vehicle-specific subsystem and component tests. Available test vary by manufacturer, year, and model, and only the available tests display in the menu.

During an active test, the tester outputs commands to the ECU in order to drive the actuators. This test determines the integrity of the system or parts by reading the engine ECU data, or by monitoring the operation of the actuators, such as switching a solenoid, relay, or switch, between two operating states.

Selecting Active Test opens a menu of test options that varies by make and model. Selecting a menu option activates the test. Follow all screen instructions while performing tests. How and what information is presented on the screen varies according to the type of test being performed. Some toggle and variable control tests display Active Test Controls at the top of the screen with data stream information below, or vice versa.

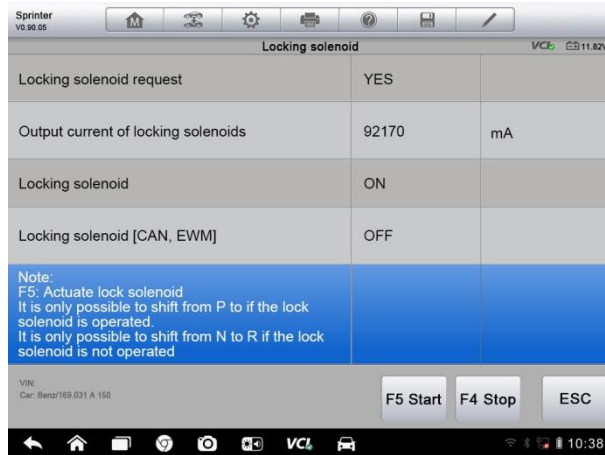

Figure 4-14 Sample Active Test Screen

The functional buttons at the lower right corner of the Active Test screen manipulate the test signals. The operational instructions are displayed on the main section of the test screen. Simply follow the on-screen instructions and make appropriate selections to complete the tests. Each time when an operation is successfully executed, message such as “Command Finished”, “Activation Successful”, or something similar displays.

Tap the **ESC** functional button to exit the test when finished.

4.5.7 Programming and Coding

Since the introduction of OBD II and leading up to modern Hybrids and EVs, computers and software in cars have been expanding at an exponential rate. In-car software is becoming one of the leading needs for service, and updating software may be the only way to fix some of these issues:

- Drivability
- Fuel Efficiency
- Power Loss
- Fault Codes
- Durability of Mechanical Parts

The Programming and Coding function is used to re-flash the vehicle control modules, it allows you to update the computer software on the vehicle to the latest version, as well as to reprogram adaptive data for certain components after making repairs or replacements.

NOTE: The programming function can only be applied through connection with the J2534 programming device, which serves as a PassThru interface to establish communication with and transfer data to the vehicle's ECU.

Available programming or coding operations vary by the test vehicle, and only the available operations display in the menu.

There are two general types of programming operations:

- A. **Adaptation Operation** – also known as *Teach-in Program*, *Control Unit Adaptation*, *Variant Coding* or something similar, is used to reprogram adaptive data for vehicle control modules after repairs or replacements of vehicle parts.

- B. **Reprogramming Operations** – downloads new version of software subscription from the on-line server database through internet access (this procedure is done automatically when the MaxiSys display tablet is connected to the internet, so there is no need to check for software subscriptions yourself), and reprograms the newest software version to the vehicle's ECU.

Selecting the Programming or Coding function opens a menu of operation options that varies by make and model. Selecting a menu option either shows a programming interface or opens another menu of additional choices. Follow all screen instructions while performing the programming operations. How and what information is presented on the screen varies according to the type of operation being performed.

Adaptation Operation

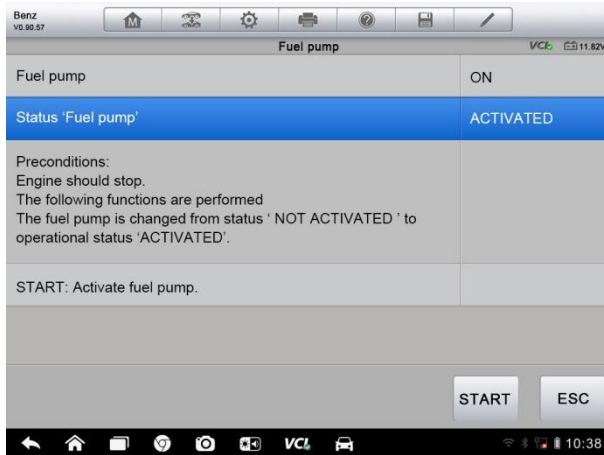

Figure 4-15 Sample Adaptation Operation Screen

The main section of the Adaptation Operation screen displays a list of operational and vehicle status information, which mainly consists of four parts:

1. The first part in the top line shows the description of the operation being performed, and the execution status is displayed on the right, such as Completed, Aborted, or Finished, etc.,
2. The second part shows the preconditions or requirements for executing the operation being selected.
3. The third part displays the current conditions of the vehicle control module being learned for comparison to the preconditions suggested by the second part. If the current condition of the control module is out of the suggested limit value, you must adjust the vehicle condition to meet the requirement.

The last part displays the instruction of how to use the functional button at the lower right corner of the screen to manipulate the teach-in operations.

Read the information carefully and check the vehicle condition accordingly, when you are sure that the vehicle is ready to be reprogrammed, simply follow the instruction provided to make appropriate selections. When the operation is done, an execution status message such as Completed, Finished or Successful, displays.

Tap the **ESC** button to exit the function.

Reprogramming Operation

Typical reprogramming operations require you to input and validate VIN number first. Tap the input box and enter the correct number, the programming interface then displays.

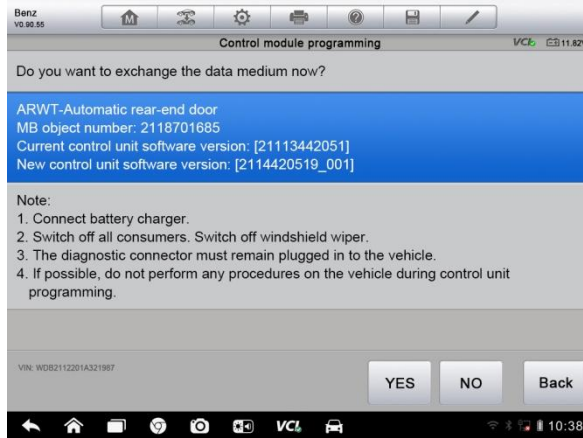

Figure 4-16 *Sample Reprogramming Operation Screen*

The main section of the reprogramming interface provides you certain hardware version, and current software versions' information, as well as the information of the newest software versions to be programmed to the control units.

Throughout the programming procedure, a series of on-screen operational instructions will display to guide you through.

Carefully read the on-screen information and follow the instruction to execute the programming procedure.

Re-flash Errors

IMPORATANT: When reprogramming onboard, always make sure the vehicle battery is fully charged and in good working condition. During reprogramming there is a risk of having the operation failure if voltage falls below the proper operation voltage. Sometimes a failed operation can be recovered, but there is a chance that failed reprogramming could ruin the control module. We recommend connecting an external battery charger to the vehicle to ensure a successful operation.

Occasionally a flash update procedure may not complete properly. Common causes of flash errors include poor cable connections between the display tablet, VCI, and vehicle, turning off the vehicle ignition switch before the flash procedure is complete, or low vehicle battery voltage.

If the process crashes, recheck all the cable connections to assure good communications and reinitialize the flash procedure. The programming procedure will automatically repeat if the previous operation does not succeed.

4.6 Generic OBD II Operations

A fast-access option for OBD-II/E OBD vehicle diagnosis is available on the Vehicle Menu screen. (*Figure 4-2*) This option presents a quick way to check for DTCs, isolate the cause of an illuminated malfunction indicator lamp (MIL), check monitor status prior to emissions certification testing, verify repairs, and perform a number of other services that are emissions-related. The OBD direct access option is also used for testing OBD-II/E OBD compliant vehicles that are not included in the Diagnostics database.

Functions of the diagnostics toolbar buttons at the top the screen are the same as those available for specific vehicle diagnostics. See [Table 4-2 Diagnostics Toolbar Buttons](#) on page 30 for details.

4.6.1 General Procedure

- **To access the OBD-II/E OBD diagnostics functions**
 1. Tap the **Diagnostics** application button from the MaxiSys Job Menu. The Vehicle Menu displays.
 2. Tap the **EOBD** button. There are two options to establish communication with the vehicle.
 - **Auto Scan** – When this option is selected the diagnostic tool attempts to establish communication using each protocol in order to determine which one the vehicle is broadcasting on.
 - **Protocol** – When this option is selected the screen opens a submenu of various protocols. A communication protocol is a standardized way of data communication between an ECM and a diagnostic tool. Global OBD may use several different communication protocols.

3. Select a specific protocol if the **Protocol** option is selected. Wait for the OBD-II Diagnostic Menu to appear.



Figure 4-17 Sample OBD-II Diagnostic Menu

NOTE: The **i** button displayed beside the function name is tappable, tapping which opens a bubble with additional function information.

4. Select a function option to continue.
 - **DTC & FFD**
 - **I/M Readiness**
 - **Live Data**
 - **O2 Sensor Monitor**
 - **On-Board Monitor**
 - **Component Test**
 - **Vehicle Information**
 - **Vehicle Status**

NOTE: Some functions are supported only on certain vehicle makes.

4.6.2 Function Descriptions

This section describes the various functions of each diagnostic option:

DTC & FFD

When this function is selected, the screen displays a list of Stored Codes and Pending Codes. When the Freeze Frame data of certain DTCs are available for viewing, a snowflake button will display on the right side of the DTC item. The Erase Codes function can be applied by tapping the functional button at the lower bottom of the screen.

Code	Status	Description
P0001	Stored	Fuel Volume Regulator Control Circuit/Open
P0002	Stored	Fuel Volume Regulator Control Circuit Range/Performance
P0003	Stored	Fuel Volume Regulator Control Circuit Low
P0004	Stored	Fuel Volume Regulator Control Circuit High
P0005	Stored	Fuel Volume Regulator Control Circuit/Open
P0006	Stored	Fuel Volume Regulator Control Circuit Low
P0007	Stored	Fuel Volume Regulator Control Circuit High

VIN: LV3FCFAE16F015498
Car: Benz/211 977 ES3/Gasoline

Clear DTC ESC

Figure 4-18 Sample DTC & FFD Screen

- **Stored Codes**

Stored codes are the current emission related DTCs from the ECM of the vehicle. OBD-II/EOBD Codes have a priority according to their emission severity, with higher priority codes overwriting lower priority codes. The priority of the code determines the illumination of the MIL and the codes erase procedure. Manufacturers rank codes differently, so expect to see differences between makes.

- **Pending Codes**

These are codes whose setting conditions were met during the last drive cycle, but need to be met on two or more consecutive drive cycles before the DTC actually sets. The intended use of this service is to assist the service technician after a vehicle repair and after clearing diagnostic information, by reporting test results after a single driving cycle.

- a) If a test failed during the driving cycle, the DTC associated with that test is reported. If the pending fault does not occur again within 40 to 80 warm-up cycles, the fault is automatically cleared from memory.
- b) Test results reported by this service do not necessarily indicate a faulty component or system. If test results indicate another failure after additional driving, then a DTC is set to indicate a faulty component or system, and the MIL is illuminated.

- **Freeze Frame**

In most cases the stored frame is the last DTC that occurred. Certain DTCs, those that have a greater impact on vehicle emission, have a higher priority. In these cases, the highest priority DTC is the one for which the freeze frame records are retained. Freeze frame data includes a “snapshot” of critical parameter values at the time the DTC set.

- **Erase Codes**

This option is used to clear all emission related diagnostic data such as, DTCs, freeze frame data and manufacturer specific enhanced data from the vehicle’s ECM, and resets the I/M Readiness Monitor Status for all vehicle monitors to Not Ready or Not Complete status.

A confirmation screen displays when the clear codes option is selected to prevent accidental loss of data. Select **Yes** on the confirmation screen to continue, or **No** to exit.

I/M Readiness

This function is used to check the readiness of the monitoring system. It is an excellent function to use prior to having a vehicle inspected for compliance to a state emissions program. Selecting I/M Readiness opens a submenu with two choices:

- **Since DTCs Cleared** – displays the status of monitors since the last time the DTCs are erased.
- **This Driving Cycle** – displays the status of monitors since the beginning of the current drive cycle.

Live Data

This function displays the real time PID data from ECU. Displayed data includes analog inputs and outputs, digital inputs and outputs, and system status information broadcast on the vehicle data stream.

Live data can be displayed in various modes, see [4.5.5 Live Data](#) on page 40 for detailed information.

O2 Sensor Monitor

This option allows retrieval and viewing of O2 sensor monitor test results for the most recently performed tests from the vehicle's on-board computer.

The O2 Sensor Monitor test function is not supported by vehicles which communicate using a controller area network (CAN). For O2 Sensor Monitor tests results of CAN-equipped vehicles, refer to [On-Board Monitor](#).

On-Board Monitor

This option allows you to view the results of On-Board Monitor tests. The tests are useful after servicing or after erasing a vehicle's control module memory.

Component Test

This service enables bidirectional control of the ECM so that the diagnostic tool is able to transmit control commands to operate the vehicle systems. This function is useful in determining how well the ECM responds to a command.

Vehicle Information

The option displays the vehicle identification number (VIN), the calibration identification, and the calibration verification number (CVN), and other information of the test vehicle.

Vehicle Status

This item is used to check the current condition of the vehicle, including communication protocols of OBD II modules, retrieved codes amount, status of the Malfunction Indicator Light (MIL), and other additional information may be displayed.

4.7 Exiting Diagnostics

The Diagnostics application remains open as long as there is an active communication with the vehicle. You must exit the diagnostics operation interface to stop all communications with the vehicle before closing the Diagnostics application.

NOTE: Damage to the vehicle electronic control module (ECM) may occur if communication is disrupted. Make sure the all connections, such as data cable, USB cable, and wireless or wired network, are properly connected at all times during testing. Exit all tests before disconnecting the test cable or powering down the tool.

➤ **To exit the Diagnostics application**

1. From an active diagnostic screen, tap the **Back** or **ESC** functional button to exit a diagnostic session step-by-step;
2. Or tap the **Vehicle Swap** button on the diagnostics toolbar to return to the Vehicle Menu screen.
3. From the vehicle menu screen, tap the **Home** button on the top toolbar; or tap the **Back** button on the navigation bar at the bottom of the screen.
4. Or tap the **Home** button on the diagnostics toolbar to exit the application directly to the MaxiSys Job Menu.

Now, the Diagnostics application is no longer communicating with the vehicle and it is safe to open other MaxiSys applications, or exit the MaxiSys Diagnostic Platform and return to the Android System's Home screen.

Chapter 5 Data Manager Operations

The Data Manager application is used to store, print, and review saved files. Most operations are controlled through the toolbar.

Selecting the Data Manager application opens the file system menu. Different file types are sorted separately under different options, there are six types of information files to be viewed or played back.

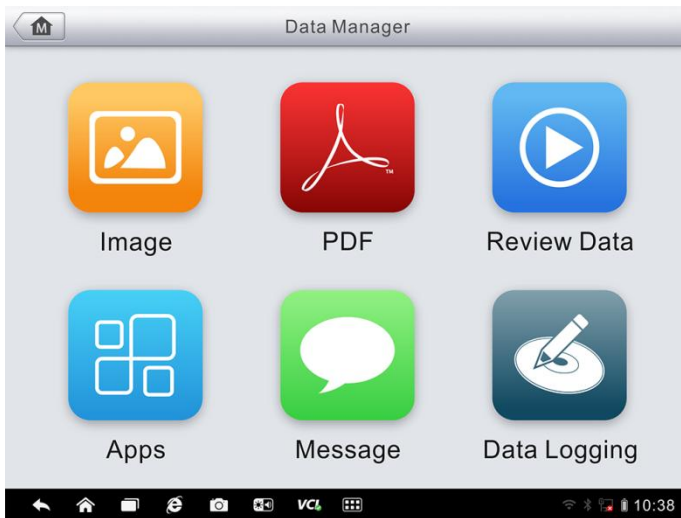

Figure 5-1 *Data Manager Main Screen*

5.1 Operations

Data Manager Operations are based on toolbar controls, details are explained in the following sections.

5.1.1 Image Files

The Image section is a JPG database containing all captured screenshot images.



Figure 5-2 Sample Image Database Screen

1. **Toolbar Buttons** – used to edit, print and delete the image files. See [Table 5-1 Toolbar Buttons in JPG Database](#) on page 58 for detailed information.
2. **Main Section** – displays the stored images.

Table 5-1 Toolbar Buttons in JPG Database

Name	Button	Description
Back		Returns to the previous screen.
Enter Edit		Touching this button shows the editing toolbar to print, delete or view image information.
Cancel		Touching this button close the editing toolbar or cancels file search.
Search		Quickly locates the image file by entering the vehicle name, test path, file name or file info.
Info		Touching this button opens a window displaying image detail information.
Print		Touching this button prints the selected image.
Delete		Touching this button deletes the selected image.

- **To edit image information**
 1. Select **Data Image** application from the MaxiSys Job Menu.
 2. Select **Image** to access the JPG database.
 3. Select an image to display in full screen.
 4. Tapping the screen once displays the editing toolbar.
 5. Tap the **Info** button to open a window displaying the image information.
 6. Tap the **Edit** button on the top right corner of the window. The editing screen displays.
 7. Edit the image information by entering the new file name, and file information.
 8. Tap **Done** to save the information and exit, or tap **Cancel** to exit without saving.

- **To delete selected images**
 1. Select **Data Image** application from the MaxiSys Job Menu.
 2. Select **Image** to access the JPG database.
 3. Tap the **Enter Edit** button to display the editing toolbar.
 4. Select the images that need to be deleted by tapping the thumbnail images, the selected thumbnail displays a tick icon at the bottom right corner.
 5. Tap the **Delete** button, and then **Delete Selected**, now the selected images are deleted.

5.1.2 PDF Files

The PDF section stores and displays all PDF files of saved data. After entering the PDF database, select a PDF file to view the stored diagnostic information.

This section uses the standard Adobe Reader application for file viewing and editing, please refer to the associated Adobe Reader manual for more detailed instructions.

5.1.3 Review Data

The Review Data section allows you to playback the recorded data frames of live data streams.

On the Review Data main screen, select a record file to playback.

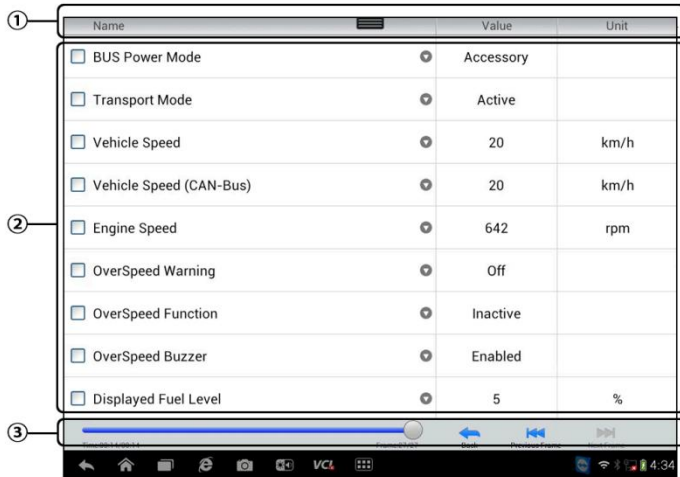

Figure 5-3 Sample Data Playback Screen

1. Drop-down Toolbar – tap the button at the top center of the screen to open the Drop-down Toolbar
2. Main Section
3. Navigation Toolbar

Use the Navigation Toolbar buttons to playback the record data from frame to frame.

Tap **Back** to exit data playback.

5.1.4 Apps Manager (Coming soon)

This section allows you to manage the applications installed on the MaxiSys Diagnostics System. Selecting this section opens a managing screen, on which you can check all the available vehicle applications, and make various controls, such as uninstalling, forcing stop, or clearing data, etc.

5.1.5 Message (Coming soon)

The MaxiSys Diagnostics Platform receives regular service or notification messages from the on-line server through the Internet. All messages that have been received and read are stored in this section automatically for later reviews.

5.1.6 Data Logging (Coming soon)

The Data Logging function records communication data and ECU information when malfunction occurred during testing procedures. The recorded data will be sent to the technical center via the Internet for troubleshooting. The technical center then feedbacks a fix file to the user, usually within 48 hours. An update for the patch will later be submitted and posted on-line for all users to download.

Chapter 6 MaxiCloud Operations

The MaxiCloud application launches the on-line troubleshooter database, which not only provides you virtually all common diagnostic trouble code (DTC) database for most vehicles, but also serves as a forum allowing you to network with other MaxiSys users, and gives you access to a vast database of repair and diagnostic tips along with proven filed fixes.

While the MaxiCloud provides the abundant troubleshooter information available, the database keeps growing with daily troubleshooting resources by recording the reported solution cases, and the advisory reports of the MaxiSys users from all over the world.

Information in the MaxiCloud database is organized into a series of diagnostic tips that are designed to quickly lead you to the root cause of a particular problem on the test vehicle, which will help you quickly find solution for various diagnostic problems.

6.1 Navigation

You need to register the device to your online account before launching the MaxiCloud platform, see [12.1 Product Registration](#) on page 90 for details.



Figure 6-1 Sample MaxiCloud Home Page

The MaxiCloud interface has 3 main areas:

1. **The Header Bar** – located across the top of the page, is used to select vehicles and perform keyword searches.
2. **The Navigation Bar** – located along the left-hand side of the page is used to access the main features of MaxiCloud.
3. **The Main Screen** – The center portion of the page presents content based on the vehicle attributes and keywords selected. The main screen also has tabs that allow you to switch between functions. Which tabs are available depend on which function is selected on the Navigation Bar.

Header Bar

The Header Bar, which runs across the top of the page, features:

- A Change Vehicle button to open the vehicle identification window, and vehicle information bar, for example “2013 > Honda > Crosstour > EX”.
- A search field used for entering keywords, codes, or symptoms.

Change Vehicle Button

The “Change Vehicle” button, located on the Header Bar, is used to identify which vehicle you want to reference on MaxiCloud. Vehicle attributes are selected from a sequence of option lists. Make a selection to advance through the lists. This data is used to filter searches so that only information that applies to the identified vehicle is shown.

➤ To select a vehicle

1. Tap the “Change Vehicle” button on the Header Bar at the top of the page.
2. Select the *year* of the vehicle from the list that displays.
3. Select the *make* of the vehicle from the list that displays.
4. Select the *model* of the vehicle from the list that displays.
5. Select the *submodel* of the vehicle from the list that displays.
6. Select the *engine* of the vehicle from the list that displays.
7. After making a full selection by choosing all vehicle attributes, the screen refreshes and the selected vehicle is now shown on the Header Bar.

6.1.1 Terminology

MaxiCloud Tip

MaxiCloud Tips are concise and complete descriptions of a real fix for a particular vehicle repair issue. A MaxiCloud Tip is a combination of proven fixes and vehicle specific data we have collected and analyzed into an all-in-one information source to help you fix vehicle problems quickly and easily.

On MaxiCloud you can search for Tips or enter your own Tip to help other community members resolve vehicle issues.

MaxiCloud Tips consist of 3 types of Tips:

1. **Autel Certified Tips** – These tips have gone through rigorous review by experts.
2. **Real Fix Tips** – These tips are gathered from actual shop repair orders and are presented in an easy to understand Complaint, Cause, Correction format.
3. **MaxiCloud Community Tips** – These are Tips that have been created by our MaxiCloud Community Members.

➤ To search for a MaxiCloud Tip

1. Tap the **Change Vehicle** button on the Header Bar at the top of the page to select a specific vehicle.
2. Enter a search term into the input field of the search bar which is located on the Main Screen.
3. The search results are displayed in a list. Find a subject that interests you; tap it to view the full details.

Fixed It!

The “Fixed It!” designation that appears in the head line of a Tip indicates that the Tip in question has actually helped at least one technician in the community repair a vehicle. Anytime you read a Tip you are given the opportunity to add to the Fixed It! count if the Tip helped you repair a problem. Each time someone taps “Fixed It!” in the tip, one is added to the total number of Fixed It! for the tip. The Fixed It! count lets you easily see what tips are actually helping to resolve vehicle issues. There is also room to add a comment about how the Tip helped you fix the problem.

6.2 Operations

The Navigation Bar is on the left side of the screen. Buttons on the Navigation Bar launch the main sections of MaxiCloud. Available Navigation Bar selections include:

- **Home** – shows the recently viewed questions and fixes, along with the Leaderboard.
- **My Cloud** – shows all your posts including Questions and Fixes in the community, and allows you to ask a question and enter a tip.
- **Search Fix** – allows you to search for information from all available resources on MaxiCloud, including: Open Questions, Tips, and Real Fixes, and displays search results.
- **Q&A** – displays the latest questions and fixes.
- **Support** – opens the FAQ page, or a message box for contacting Customer Service by email.

6.2.1 Home

Home, is the first option on the Navigation Bar along the left side of the screen, opens the home page on MaxiCloud. There are two functions available.

- **Leaderboard** – shows the top ranked MaxiCloud community members.
- **My Recently Viewed** – shows a list with links to the Questions, Tips, and Real Fixes that you recently visited.

Leaderboard

The Leaderboard shows the top ranked MaxiCloud community members. Community members are awarded points for answering questions, and those who gather the most points show on the MaxiCloud Leaderboard. The more points you have the better the change you have to get on the Leaderboard.

To show on the Leaderboard the community members must answer questions to get points.

Points System:

- 1 point is awarded for answering a question.
- 5 points are awarded if your answer is rated as “Good Answer” by the MaxiCloud community member who asked the question.
- 10 points are awarded if your answer is rated as the “Best Answer” by the MaxiCloud community member who asked the question.

6.2.2 My Cloud

My Cloud, the second option on the Navigation Bar along the left side of the screen, opens your personal MaxiCloud page. To access the features on My Cloud page you can either select from the tabs or use the links on the top of the page:

- **My Questions** – opens a list with links to question that you have posted to the community.
- **My Tips** – opens a list with links to tips that you have contributed to the community.
- **Ask the Experts** – allows you to post a question to the community.
- **Enter a Tip** – allows you to share your personal repair experience with the community.

Tap **My Cloud** on the Navigation Bar along the left side of the screen, to display all questions and tips that you have contributed to the community.

➤ To ask a question on MaxiCloud

1. If not already done, tap **Change Vehicle** on the Header Bar and enter the identifying attributes of the vehicle you would like to ask a question about.
2. Tap **My Cloud** on the Navigation Bar along the left-side of the screen to open the My Cloud page.
3. On the My Cloud page find **Ask the Experts**; tap this link to open the Question Page.

The Question page has 4 sections:

- **Subject** – this is where you enter a brief subject for the question.
- **Symptoms** – this is where you will describe how the vehicle is behaving.

- **Diagnostics Steps Performed/Parts Replaced** – include any previous diagnostic tests that you performed, including the results of the tests. Also list any parts that were replaced during previous diagnostic work.
 - **Your Question** – ask a clear and concise question that you want to ask the community. Be sure to be descriptive and concise when asking your question.
4. Tap the **Cancel** button at the right-side bottom of the page to delete your question and return to the My Cloud page. Or,
 5. Tap the **Submit** button at the right-side bottom of the page to ask your question of the community.

“Good Answer” or “Best Answer” ratings

Rating answers is one way to give back to the MaxiCloud community. The member that originally asked the question gets to select a “Good Answer” and a “Best Answer” from all of the responses. The community member that provided the Good Answer or Best Answer to a question is recognized for their contribution.

About Good Answers and/or Best Answers:

- Only one answer can be rated “Best Answer”.
- More than one answer can be rated “Good Answer”.
- Only the MaxiCloud community member who asked the question can rate the answers.

Close a Question

Questions that you post to the community need to be closed once the vehicle repair issue has been resolved. You are encouraged to document the fix, and an important part doing so is providing information on what actually fixed the vehicle so that other MaxiCloud community members can use the information as well. To close a question click the “Close Question” button on the right side of your question. Your question is now converted to a MaxiCloud Community Tip. As part of closing the question, if you haven’t already, you will be asked to award Best Answer and Good Answers ratings to reward those community members that helped you by giving them Leaderboard points.

Create a Tip

If you have a new fix to a specific vehicle problem please share! Create a MaxiCloud community Tip to share your expertise with other technicians in the MaxiCloud community.

A MaxiCloud community Tip is a short yet complete description of the repair for a particular vehicle problem.

➤ To ceate a new MaxiCloud Tip

1. Select **My Cloud** from the Navigation Bar.
2. Tap **Change Vehicle** from the Header Bar and enter the identifying attributes of the vehicle you are writing the Tip about.
3. On the My Cloud page find **Enter a Tip**; tap this link to open the Tip Page.
4. Enter the Tip Title in the Title field.
5. Compose your Tip in the Content field. Includes as much information as possible, while keeping the information concise and to the point. A Tip should provide accurate information that is easy to read, understand, and follow.
6. Tap the **Cancel** button at the right-side bottom of the page to delete your tip and return to the My Cloud page. Or,
7. Tap the **Submit** button at the right-side bottom of the page to contribute your tip to the community.

6.2.3 Search Fix

Search Fix, the third option on the Navigation Bar along the left side of the screen, presents search results for the active vehicle. Search results are listed in various categories:

- **All** – includes all search results, including related Questions, Tips, an Real Fixes to your search.
- **Questions** – presents a list of open Question discussed in the community that may be pertinent to your search.
- **Tips** – presents a list of Tips that directly correlate to your search criteria. Select a Tip from the list to open and review the complete Tip.

- **Real Fixes** – presents a list of Tips that have been gathered from actual shop repair orders and are presented in an easy to understand Complaint, Cause, Correction format.

6.2.4 Q&A

Q&A, the fourth option on the Navigation Bar along the left side of the screen, presents the latest updated questions and tips in MaxiCloud community. There are two tabs available to look up:

- **Latest Questions** – displays a list of latest posted questions. Select a question from the list a join the discussion or submit an answer to contribute your expertise.
- **Latest Tips** – displays a list of latest posted tips. Select a tip from the list to find out the repair advice and tip contributed by a community member. If you find the tip is helpful to solve your repair problem, you can give the tip one Fixed It! point by tapping it.

6.2.5 Support

Support, the last option on the Navigation Bar along the left side of the screen, opens a page that provides 2 ways to gain support from MaxiCloud:

1. A message form to contact the administrator of MaxiCloud.
2. A Frequently Asked Questions (FAQ) link that answers the most frequent questions we hear from MaxiCloud community members.

If you wish to contact the administrator of this site please use the contact form. Select “Support” from the Navigation Bar to open the comment window. To allow the administrator to respond to your question or issue, the following information should be provided:

- Your name
- A contact email address
- A contact Phone number

Chapter 7 Settings Operations

Selecting Settings application opens a setup interface, on which you can adjust default setting and view information about the MaxiSys system. There are seven options available for the MaxiSys system settings:

- **Unit**
- **Language**
- **Printing Setting**
- **Wired Network**
- **Push Message**
- **About**
- **System Settings**

7.1 Operations

7.1.1 Unit

This option allows you to adjust the measurement unit for the diagnostic system.

➤ **To adjust the unit setting**

1. Tap the **Settings** application on the MaxiSys Job Menu.
2. Tap the **Unit** option on the left column.
3. Select the required measurement unit, Metric or English. A tick icon will display to the right of the selected unit.
4. Tap the **Home** button on the top left corner to return to the MaxiSys Job Menu. Or select another setting option for the system setup.

7.1.2 Language

This option allows you to adjust the display language for the MaxiSys system.

➤ **To adjust the language setting**

1. Tap the **Settings** application on the MaxiSys Job Menu.
2. Tap the **Language** option on the left column.
3. Select the required language. A tick icon will display to the right of the selected language.
4. Tap the **Home** button on the top left corner to return to the MaxiSys Job Menu. Or select another setting option for the system setup.

7.1.3 Printing Setting

This option provides three options for printer connection, allowing you to print any data or information anywhere and anytime via PC network or Wi-Fi. For more information about printing, see [3.3.1 Printing Operation](#) on page 19.

➤ **To setup the printer connection**

1. Tap the **Settings** application on the MaxiSys Job Menu.
2. Tap the **Printing Setting** option on the left column.
3. Select the desired connection type to the printer. A tick will display to the left of the selected option.
 - **Print to Network** – connects to the printer through the PC via an existing LAN
 - **Print to Wi-Fi** – connects the printer through the PC via Wi-Fi connection
4. Tap the **Home** button on the top left corner to return to the MaxiSys Job Menu. Or select another setting option for the system setup.

7.1.4 Wired Network

This option allows you to enable or disable the wired network connectivity, as well as to perform Ethernet configuration.

➤ **To operate Ethernet configuration**

1. Tap the **Settings** application on the MaxiSys Job Menu.
2. Tap the **Wired Network** option on the left column.
3. Tap the **ON/OFF** button to enable the Wired Network connection. If the connectivity is enabled the button turns blue, or if disabled the button turns gray.
4. Tap the  button to the right of the Ethernet Configuration option, a setup window displays.
5. Select a connection type:
 - **DHCP** – obtains the LAN IP address automatically
 - **Static IP** – allows manual input of IP address
6. If Static IP is selected, you need to enter the IP values manually.

NOTE: If you are not sure about the specific IP address values, please contact your network administrator.

7. Tap **Save** to save the Ethernet configuration setting; or tap **Cancel** to exit without saving.

7.1.5 Push Message

This option allows you to turn the Push Message function on or off. The Push Message function configures the MaxiSys tablet to receive regular on-line messages from the server for system update notifications or other service information via Internet. It is highly recommended to keep this function on all the time, so you won't miss out any new update for MaxiSys or event from Autel. Internet access is required for receiving on-line messages.

➤ **To enable the Push Message function**

1. Tap the **Settings** application on the MaxiSys Job Menu.
2. Tap the **Push Message** option on the left column.
3. Tap the **ON/OFF** button to enable or disable the Push Message function. If the function is enabled the button turns blue, or if disabled the button turns gray.
4. Tap the **Home** button on the top left corner to return to the MaxiSys Job Menu. Or select another setting option for the system setup.

When the Push Message function is turned on, and new messages are received by the MaxiSys device, a notification message displays on the MaxiSys Job Menu. Press on the message bar and drag it down, and the received messages are shown in the list, slide the list up or down to view all if the message list covers more than one screen.

Tapping a specific message launches the corresponding application. For example, if you tap on an Update notification message, the Update application will be launched.

7.1.6 About

The About option provides information of the MaxiSys diagnostic device regarding the product name, version, hardware, and serial number, etc.

➤ To check the MaxiSys product information in About

1. Tap the **Settings** application on the MaxiSys Job Menu.
2. Tap the **About** option on the left column. The product information screen displays on the right.
3. Tap the **Home** button on the top left corner to return to the MaxiSys Job Menu. Or select another setting option for the system setup.

7.1.7 System Settings

This option provides you a direct access to the Android background system setting interface, on which you can adjust various system settings for the Android system platform, regarding wireless and networks settings, various device settings such as sound and display, as well as system security settings, and check the associated information about the Android system, etc. Refer to Android documentation for additional information.

Chapter 8 Shop Manager Operations

The Shop Manager application helps you to manage the workshop information, customer information records, and keep test vehicle history records, which can be a great assist in dealing with daily workshop business and improves customer service. There are three main functions available:

- **Vehicle History**
- **Workshop Information**
- **Customer Manger**

8.1 Vehicle History

This function stores records of test vehicle history, including vehicle information and the retrieved DTCs from previous diagnostic sessions, and displays all information in an easy-to-check table list, on which you can view summarized details and manually input other information about the test vehicle and diagnostic loggings, etc. The Vehicle History also provides direct access to the previously tested vehicle and allows you to restart a diagnostic session without the need to do vehicle identification again.

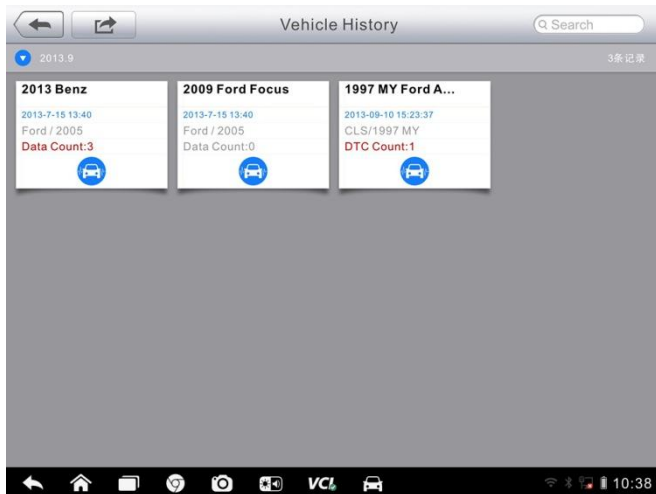









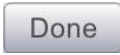

Figure 8-1 Sample Vehicle History Screen

1. **Top Toolbar Buttons** – navigates and make various controls of the application.
2. **Main Section** – displays all the vehicle history records information.

Table 8-1 *Top Toolbar Buttons in Vehicle History*

Name	Button	Description
Back		Returns to the previous screen.
Diagnostics		Touching this button directs you to the vehicle's Diagnostics screen to activate a direct test session.
Enter Edit		Touching this button shows the editing toolbar to print or delete the selected file(s).
Delete		Touching this button deletes the selected vehicle record item from the list.
Search		Quickly locates the vehicle record by entering the vehicle name or test path.
Cancel		Touching this button to cancel edit or file search.
Edit		Touching this button allows you to edit information for the displayed file.
Add Account		Touching this button to create a new customer account file.
History Notes		Touching this button opens a notes form, which allows you to create audio record, attach picture or video, or edit text notes, etc.
Vehicle History		Touching this button opens the Vehicle History screen which displays the correlated test vehicle records.
Done		Complete editing and save the file.

- **To activate a test session for the recorded vehicle**
 1. Tap the **Shop Manager** application on the MaxiSys Job Menu.
 2. Select **Vehicle History**
 3. Tap the **Diagnostics** button at the bottom of the thumbnail of a vehicle record item. Or,
 4. Select a vehicle record item by tapping the thumbnail.
 5. A Historical Test record sheet displays, check the recorded information of the tested vehicle, and tap the Diagnostics button on the upper right corner.
 6. The vehicle's Diagnostics screen displays, now a new diagnostic session is activated, see [4.5 Operations](#) on page 33 for detailed instructions on vehicle diagnostic operations.

8.1.1 Historical Test Record

The Historical Test record sheet of the tested vehicle is a detailed data form, which includes all general information of the vehicle such as vehicle year, make and model, etc., and the diagnostic trouble codes retrieved from the previous test sessions, as well as other service details which can be added manually by the technician himself.

The screenshot shows a mobile application interface for a 'Historical Test' record. The title bar at the top reads 'Historical Test' and includes navigation icons. The main content area is a form with the following sections:

- Vehicle Info:** Vehicle Title (Ford Mustang), Year (2008), Make (Ford), Model (Mustang), SubModel, Engine, VIN (FA...), License, Odometer/Mileage, Color.
- Service Record:** Technician, Technician Notes.
- Customer Info:** First Name, Last Name (John), Add to Customer button.
- DTC:** Codes, Status, Descriptions, System. A table below shows 'No data'.
- Activate:** A green plus icon and a text input field.

Overlaid on the top right of the form are two buttons: a 'Print' button and a 'Delete' button.

Figure 8-2 Sample Historical Test Record Sheet

➤ **To edit the Historical Test record sheet**

1. Tap the **Shop Manager** application on the MaxiSys Job Menu.
2. Select **Vehicle History**.
3. Select the specific vehicle history record thumbnail from the main section. The Historical Test record sheet displays.
4. Tap the **Edit** button to start editing.
5. Tap on each item to input the corresponding information or add attaching files or images.

NOTE: The vehicle VIN number, or license and the customer information account are correlated by default. Adding one of the information will automatically associate the other item in the record sheet, provided that the later one exists.

6. Tap **Add to Customer** to correlate the Historical Test record sheet to an existing customer account, or add a new associating account to be correlated with the test vehicle record. See [8.3 Customer Manager](#) on page 78 for more information.
7. Tap **Done** to save the updated record sheet, or tap **Cancel** to exit without saving.

8.2 Workshop Information

The Workshop Information form allows you to edit, input and save the detailed workshop information, such as shop name, address, phone number and other remarks, which, when printing vehicle diagnostic reports and other associated test file, will appear as the header of the printed documents.

The image shows a mobile application interface titled "Workshop Information". It features a form with several input fields: "Shop Name", "Address", "Postal Code", "City", "State", "Phone", "Fax", "Manager Name", "Manager Title", "Email", "Webpage", "Slogan", and "Comment". The form is displayed on a tablet or smartphone screen, with a navigation bar at the bottom showing various icons and the time 4:56.

Figure 8-3 *Sample Workshop Information Sheet*

- **To edit the Workshop Information sheet**
 1. Tap the **Shop Manager** application on the MaxiSys Job Menu.
 2. Select **Workshop Information**.
 3. Tap the **Edit** button on the top toolbar.
 4. Tap on each field to input the appropriate information.
 5. Tap **Done** to save the updated workshop information sheet, or tap **Cancel** to exit without saving.

8.3 Customer Manager

The Customer Manager function allows you to create and edit customer accounts. It helps you to save and organize all customer information accounts that are correlated with the associated test vehicle history records, which is a great support for the arrangement of daily workshop business.

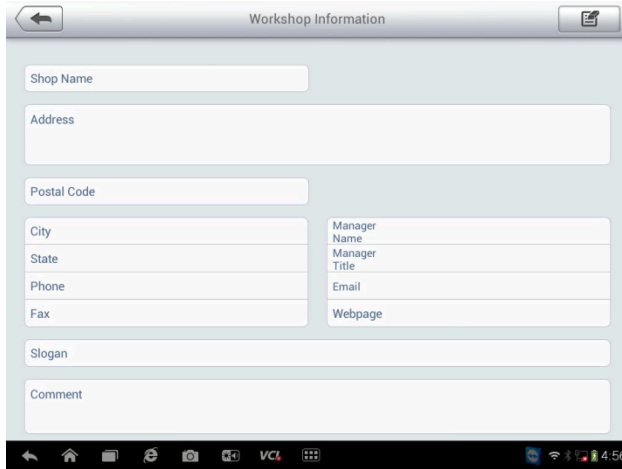
- **To create a customer account**
 1. Tap the **Shop Manager** application on the MaxiSys Job Menu.
 2. Select **Customer Manager**.
 3. Tap the **Add Account** button. An empty information form displays, tap each field to input the appropriate information.

NOTE: The items that must be filled are indicated as required fields.

4. Tap the “+” photo frame beside the Name chart to add a photo. A sub menu displays, select **Take Photo** to take a new photo for the account, or select **Choose Photo** to choose from the existing files.
 5. Some customers may have more than one vehicle for service; you can always add new vehicle information to the account to be correlated. Tap **Add New Vehicle Information**, and then fill in the vehicle information. Tap the **(X)** button to cancel adding.
 6. Tap **Done** to save the account, or tap **Cancel** to exit without saving.
- **To edit a customer account**
1. Tap the **Shop Manager** application on the MaxiSys Job Menu.
 2. Select **Customer Manager**.
 3. Select a customer account by tapping the corresponding name card. A Customer Information sheet displays.
 4. Tap the **Edit** button on the top toolbar to start editing.
 5. Tap on the input field where needs altered or supplemented, and enter updated information.
 6. Tap **Done** to save the updated information, or tap **Cancel** to exit without saving.
- **To delete a customer account**
1. Tap the **Shop Manager** application on the MaxiSys Job Menu.
 2. Select **Customer Manager**.
 3. Select a customer account by tapping the corresponding name card. A Customer Information sheet displays.
 4. Tap the **Edit** button on the top toolbar to start editing.
 5. Tap the **Delete Customer Information** button. A confirmation message displays.
 6. Tap **OK** to confirm the command, and the account is deleted. Tap **Cancel** to cancel the request.

History Notes

The History Notes function allows you to add audio and video records, text notes and photos, to keep multi-media work logs for the associated customer account, which can be very helpful when dealing with repeat customers. Keeping notes for each vehicle serviced for each customer will keep you always on track and well organized in business.

➤ To access History Notes

1. Tap the **Shop Manager** application on the MaxiSys Job Menu.
2. Select **Customer Manager** or **Vehicle History**.
3. Select a customer account by tapping the corresponding name card. A Customer Information sheet displays (if **Customer Manager** is selected). Or, select a vehicle history record item to open the Historical Test record sheet (if **Vehicle History** is selected).
4. Tap the **History Notes** button on the top bar. Now the History Notes screen displays.

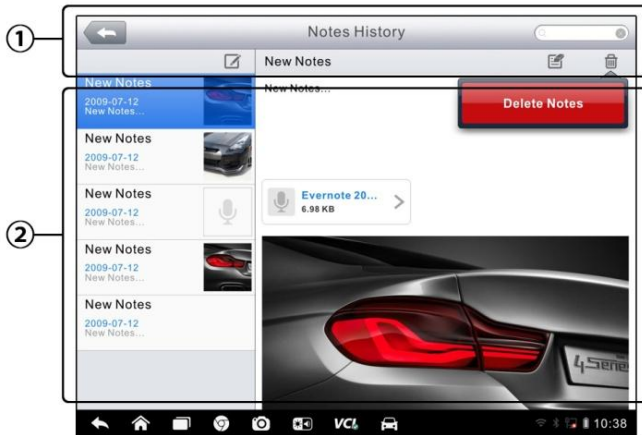









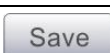

Figure 8-4 Sample History Notes Screen

1. **Functional Buttons** – navigates and make various controls of the function.
2. **Main Section** – displays the notes list on the left column and the detail information of the selected note on the right column.

Table 8-2 Function Buttons in History Notes

Name	Button	Description
Back		Returns to the previous screen.
Delete		Touching this button deletes the selected note.
Search		Quickly locates the note item by entering the note title.
Cancel		Touching this button to cancel edit or file search.
Edit		Touching this button opens an edit window allowing you to edit notes and attaching files.
Add Notes		Touching this button to add notes in History Notes.
Audio Record		Performs audio recording and creates audio files.
Add Photos		Opens the image file for selection, and adds the selected photos to History Notes.
Take a Video		Records a video and adds the file to History Notes.
Take a Photo		Takes photos and adds the files to History Notes.
Save		Save Notes.

➤ **To add a note in History Notes**

1. Access History Notes.
2. Tap the **Add Notes** button. An edit window displays.
3. Tap on the Title bar to input a note title.
4. Tap on the blank space below to edit a text note or remark.
5. Select a function button on the top to add files in any form you choose.
6. Tap **Save** to save the note, record, or photo; tap **Discard** or **Cancel** to exit without saving.

Chapter 9 Update Operation

The internal programming of the MaxiSys Diagnostic System, known as the firmware, can be updated using the Update application. Firmware updates increase the MaxiSys applications' capabilities, typically by adding new tests, new models, or enhanced applications to the database.

The display device automatically searches for available updates for all of the Maxisys components when it is connected to the internet. Any updates that are found can be downloaded and installed on the device. This section describes installing an update to the MaxiSys Diagnostic System firmware. A notification message displays if an update is available when the Push Message function is enabled in the Settings application (See [7.1.5 Push Message](#) on page 72 for details).

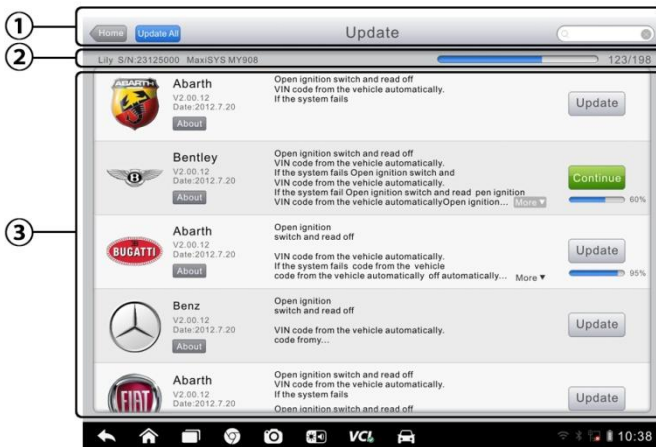

Figure 9-1 Sample Update Screen

1. Navigation and Controls

- Home Button – returns to the MaxiSys Job Menu
- Update All – updates all available updates
- Search Bar – search specific update item by inputting the file name, for example: a vehicle make

2. Status Bar

- Left Side – displays the MaxiSys device model information and serial number.
- Right Side – displays an update progress bar indicating the completion status.

3. Main Section

- Left Column – displays vehicle logos and update firmware version information; tap the **About** button displays a function list in PDF showing more details about the firmware
- Middle Column – displays a brief introduction about the new changes to the firmware operation or capabilities. Tap **More** to show all details; and tap **Less** to collapse.
- Right Column – according to the operation status of each firmware item, the button displays differently.
 - a) Tap **Update** to update the selected item.
 - b) Tap **Pause** to suspend the updating procedure.
 - c) Tap **Continue** to go on updating the suspended update.

➤ To update the firmware

1. Power up the MaxiSys Display Tablet, and ensure that it is connected to a power source and with steady internet connection.
2. Tap the **Update** application button from the MaxiSys Job Menu; or tap the update notification message when received one. The Update application screen displays.
3. Check all available updates:
 - If you decide to update all the items, tap **Update All** on control button.
 - If you only want to update some individual items, tap the **Update** button on the right column of the specific items.
4. Tap the **Pause** button to suspend the updating process. When you tap **Continue** to renew the update, the updating process will resume from the break point.
5. When the updating process is completed, the firmware will be installed automatically. The new version will replace the original version if there is one.

Chapter 10 VCI Manager Operations

This application allows you to check the status of and to pair the MaxiSys™ Display Tablet to the VCI device, either the J2534 Programming Device or the Bluetooth Diagnostic Interface.



Figure 10-1 Sample VCI Manager Screen

1. **Connection Mode** – there are two connection modes available for selection. The connection state is displayed alongside.
 - Bluetooth Pairing – when paired to a Bluetooth device, the connection state displays as Paired; otherwise it displays as Unpaired.
 - Wired Network Connection (for J2534 ECU Programming Device only) – when connected to a Local Area Network, the connection status displays as connected; otherwise it displays as Disconnected.

➤ Select a connection mode to manage and set up connection.
2. **Settings** – this section allows you to manage wireless pairing or set up network connection.
 - Bluetooth Setting – searches and displays the type and a partial serial number for all of the devices available for pairing. Tap a required device to start pairing.
 - Ethernet Setting – allows you to perform network configuration.

10.1 Bluetooth Pairing

The VCI device needs to be either connected to a vehicle or to an available power source, so that it is powered up during the synchronization procedure. Make sure the MaxiSys Display Tablet has a charged battery or is connected to an AC/DC power supply.

➤ **To pair the VCI device with the Display Tablet**

1. Power on the MaxiSys Display Tablet.
2. Connect the 26-pin end of the data cable to the J2534 ECU Programming Device's vehicle data connector.
3. Connect the 16-pin end of the data cable to the vehicle data link connector (DLC).
4. Tap the **VCI Manager** application on the MaxiSys Job Menu of the display tablet.
5. Select Bluetooth from the connection mode list.
6. Tap the **Scan** button at the top right corner. Now the device starts searching for available pairing units.
7. Depending on the VCI type you use, the device name may display as Maxi suffixed with a serial number. Select the required device for pairing.
8. A Bluetooth pairing request window displays and requires you to enter a PIN number. The default number is usually 0000 or 1234. Enter the PIN number into the input field.
9. Tap **OK** and the device starts pairing the selected device.
10. When pairing is successfully done, the connection status displayed to the right of the device name is shown as Paired.
11. The VCI button on the system Navigation bar at the bottom of the screen shall display a green tick icon, indicating the display tablet is connected to the VCI device.
12. Tap the paired device again to unpair it.
13. Tap the **Home** button on the top left to return to the MaxiSys Job Menu.

NOTE: A VCI device can be paired to only one Display Tablet each time, and once it's been paired, the device will not be discoverable for any other unit.

10.2 Wired Network Connection

The Wired Network is only available for connecting the MaxiSys Display Tablet with J2534 ECU Programming Device or to an existing LAN. This section describes connecting the display tablet with the J2534 ECU Programming Device through the Ethernet cable.

The J2534 ECU Programming Device needs to be either connected to a vehicle or to an AC/DC power source, so that it is powered up when communicating with the display tablet. Make sure the MaxiSys Display Tablet has a charged battery or is connected to an AC/DC power supply.

➤ **To connecte the display tablet with the J2534 ECU Programming Device through wired network**

1. Power on the MaxiSys Display Tablet.
2. Connect the 26-pin end of the data cable to the J2534 ECU Programming Device's vehicle data connector.
3. Connect the 16-pin end of the data cable to the vehicle data link connector (DLC).
4. Connect the MaxiSys Display Tablet to the programming device with the accompanied Ethernet serial cable.
5. Tap the **VCI Manager** application on the MaxiSys Job Menu of the display tablet.
6. Select Wired Network from the connection mode list. Now the Ethernet Setting interface displays.
7. Select a connection type:
 - **DHCP** – obtains the LAN IP address automatically
 - **Manual** – allows you to enter IP address manually
8. If **Manual** is selected, you need to set the IP address on your own.

NOTE: If you are not sure about the specific IP address values, please contact your network administrator.

9. Tap **Apply** to set up the wired network connection.
10. Tap the **Home** button on the top left to return to the MaxiSys Job Menu.

When the wired network is successful connected, the connection status shall display as Connected, and the two status lights at the corners alongside the Ethernet Ports on the display tablet illuminate. The solid amber light indicates steady connection, and the flashing green light indicates active communication, between the units.

Chapter 11 Remote Desk Operations

The Remote Desk application launches the TeamViewer Quick Support program, which is a simple, fast and secure remote control interface. You can use the application to receive ad-hoc remote support from Autel's support centre, colleagues, or friends, by allowing them to control your MaxiSys tablet on their PC via the TeamViewer software.

11.1 Operations

If you think of a TeamViewer connection as a phone call, the TeamViewer ID would be the phone number under which all TeamViewer Clients can be reached separately. TeamViewer computers and mobile devices that run TeamViewer are identified by a globally unique ID. The first time the Remote Desk application is started, this ID is generated automatically based on the hardware characteristics and will not change later on.

Make sure the MaxiSys Display Tablet is connected to the Internet before launching the Remote Desk application, so that the Display Tablet is accessible to receive remote support from the third party.



Figure 11-1 Sample Remote Desk Screen

- **To receive remote support from a partner**
 1. Power on the MaxiSys Display Tablet.
 2. Tap the **Remote Desk** application on the MaxiSys Job Menu. The TeamViewer interface displays and the device ID is generated and shown.
 3. Your partner must install the Remote Control software from the accompanied CD of MaxiSys tool kit, or download the TeamViewer full version program online, and start the software on his/her computer at the same time, in order to provide support and take control of the display tablet remotely.
 4. Provide your ID to the partner, and wait for him/her to send you a remote control request.
 5. A popup displays to ask for your confirmation to allow remote control on your device.
 6. Tap **Allow** to accept, or tap **Deny** to reject.

Refer to the associated TeamViewer documents for additional information.

Chapter 12 Support Operations

This application launches the Support platform which synchronizes Autel's on-line service base station with the MaxiSys display tablet. In order to synchronize the device to your on-line account, you need to register the product through the Internet when you use it for the first time. The Support application is connected to Autel's service channel and on-line communities which provides the quickest way for problem solutions, allowing you to submit complaints or sent help requests to obtain direct services and supports.

12.1 Product Registration

In order to get access to the Support platform and obtain update and other services from Autel, you are required to register the MaxiSys Diagnostic Device the first time you use it.

➤ **To register the diagnostic device**

1. Visit the website: <http://pro.auteltech.com>.
2. On the Sign In page, input your account ID and other information to log in, if you already have an account.
3. If you are a new member to Autel and do not have an account yet, click the **Create Autel ID** button on the left side.
4. Enter the required information in the input fields, read through Autel's Terms and Conditions and tick on **Agree**, and then click **Create Autel ID** at the bottom to continue.
5. The online system will automatically send a confirmation email to the registered email address. Validate your account by clicking the link provided through the mail. A product registration screen opens.
6. Find out the device's serial number and password from the About section of the Settings application on the MaxiSys Display Tablet.
7. Select the product model of your device, enter the product serial number and password on the Product Registration screen, and click **Submit** to complete the registration procedure.

12.2 Support Screen Layout

The Support application interface is navigated by 4 simple buttons on the top navigation bar, operation of each is described below in turn from left to right:

- **Home Button** – returns to the MaxiSys Job Menu.
- **Back** – returns to the previous screen, each press takes you back one step.
- **Forward** – each press moves forward one screen until you've reached the last screen visited.
- **Refresh** – reload and update the screen.

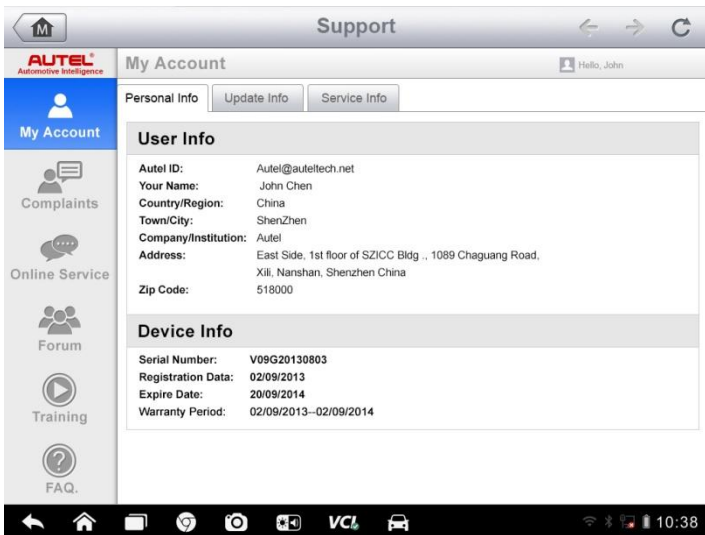

Figure 12-1 Sample Support Application Screen

The main section of the Support screen is divided into two sections. The narrow column on the left is the main menu; selecting one subject from the main menu displays the corresponding functional interface on the right.

12.3 My Account

The My Account screen displays the comprehensive information of the user and the product, which is synchronized with the on-line registered account, including User Info, Device Info, Update Info and Service Info.

Personal Info

The User Info and Device Info are both included under the Personal Info section.

- **User Info** - displays detailed information of your registered on-line Autel account, such as your Autel ID, Name, Address and other contact information, etc.
- **Device Info** – displays the registered product information, including the Serial Number, Registration Date, Expire Date, and Warranty Period.

Update Info

The Update Info section displays a detailed record list of the product's software update history, including the product serial number, software version or name, and the update time.

Service Info

The Service Info section displays a detailed record list of the device's service history information. Every time the device has been sent back to Autel for repair, the device's serial number and the detailed repair information, such as the fault type, changed components, or system reinstallation, etc, will be recorded and updated to the associated online product account, which will be synchronized to the Service Info section.

12.4 User Complaint

The User Complaint screen allows you to establish a new complaint case, as well as to view historical complaint records.

Screen Layout

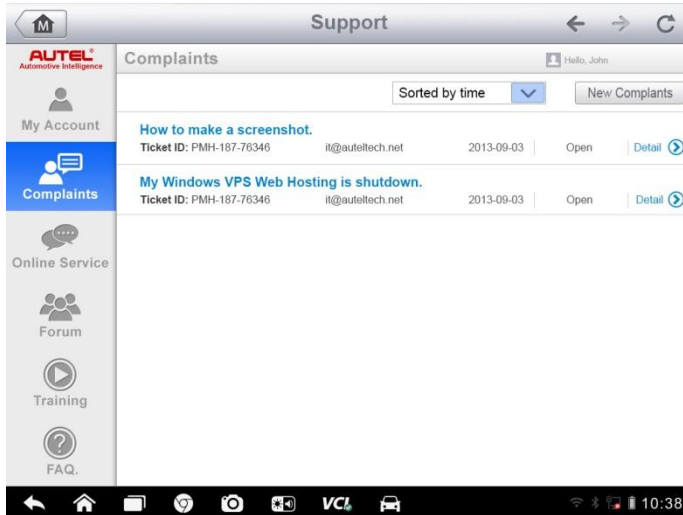

Figure 12-2 Sample Complaint Screen

The User Complaint screen consists of two parts.

1. Option Bar

- **Period Filter** – displays only the complaint records within the defined period on the list.
- **Status Filter** – displays the corresponding complaint records according to the selected case status.
- **New Complaint Button** – starts a new complaint case.

2. Complaint List

The complaint list normally displays all the complaint records of all time and all status by default. The summary information for each complaint item includes the Subject Name, Ticket ID, User's Account ID, Date, and the Case Status.

There are four kinds of the case status:

- **Open** – indicates the complaint case has been started but not processed yet.
- **Suspended** – indicates the complaint case is being processed.

- **Waiting Customer Reply** – indicates the complaint has been replied by the service personnel, and requires feedback from the customer.
- **Closed** – indicates the complaint case has been processed, solved, and ended.
- To view the detailed complaint session, tap the ⊖ button on the right side of the case item.
- **To establish a new complaint session**
 1. Register the product online.
 2. Tap the **Support** application on the MaxiSys Job Menu. The device information is automatically synchronized with the online account.
 3. Tap **Complaint** on the Main Menu.
 4. Tap the **New Complaint** button at the upper right corner. A selection menu with a category of service channels displays.
 5. Select your target service channel and click **Next** to continue. A standard complaint form displays, on which you are allowed to enter detailed information, such as personal information, vehicle information, and device information, you can also attach image or PDF files with the form.
 6. Enter in each input field the appropriate information, in order to settle the complaint more efficiently, it is recommended to fill out the complaint form as detailed as possible.
 7. Select the required processing time on the last section according to the urgency of the case.
- Tap **Submit** to send the completed form to Autel's online service center, or tap **Reset** to refill it. The submitted complaints will be carefully read and handled by the service personnel, and the respond speed may depend on the processing time you've required.
- **To make a reply in a complaint session**
 1. Register the product online.
 2. Tap the **Support** application on the MaxiSys Job Menu. The device information is automatically synchronized with the online account.

3. Tap **Complaint** on the Main Menu.
4. Select an existing complaint case item on the record list by tapping the  button on its right side. The screen displays the complaint session details.
5. Tap the **Post Reply** button on the upper right side after viewing, to make a reply. An edit screen displays.
6. Input the content in the input field, and if necessary, upload an attaching file.
7. Tap **Submit** to post the reply.
8. Tap the **States** selection drop-down menu to reset a case state.
9. Tap the **Update** button to commit the newest update.

12.5 Support Communities

The Support Communities section launches and synchronizes with the Technical Forums on Autel's official website <http://pro.auteltech.com>, where you are allowed to discuss technical topics or share information with, as well as ask for technical advices or offer technical supports to all other members in Autel's online support communities.

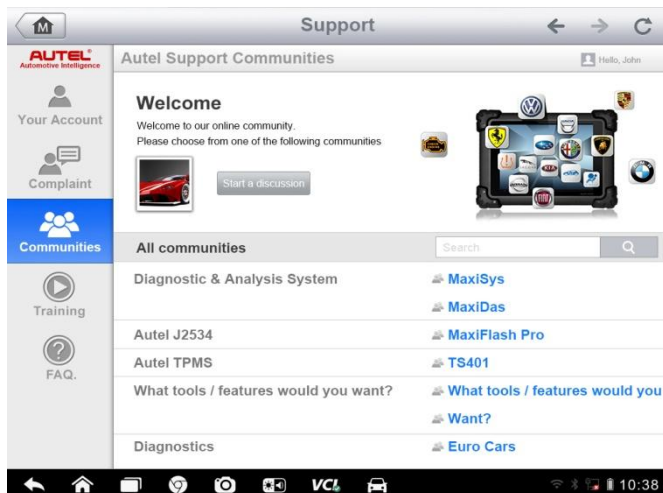



Figure 12-3 Sample Communities Home Screen

➤ **To start a discussion**

1. Tap **Start a discussion** on the Communities Home screen. A list of the major forums is displayed.
2. Select a desired group according to the subject you are about to discuss. For example, if you are going to ask a question about the MaxiSys table, tap **MaxiSys** to start a discussion.
3. Enter your topic and the discussion content in the appropriate input field.
4. Select a category or edit tags for the discussed post. This will help other members with similar interest to find your post.
5. Tap **OK** to submit the post.

➤ **To join and reply to a discussion post**

1. Select a forum group that you are interested in, whether by the product or the features, on the Communities Home screen. A list of the latest posts is displayed.
2. Select a specific category on the Categories menu to better pinpoint the topics you are most interested with.
3. Tap the  button on the right side of the topic item to view the discussion. The post contents are displayed.
4. Browse through the post by sliding the screen up and down. Tap **Go to original post** when reaching the end of the discussion to return to the first post.
5. Tap **Reply** to reply a specific post, or tap **Reply to original post** to join and continue the whole discussion.
6. Enter your comment in the input field, and tap **OK** to submit your post.

User Profile

The User Profile section allows you to set personal Avatar, check your member status and other information, as well as to review your personal posts in the communities.

Tap the Avatar image on the Communities screen to open the User Profile.

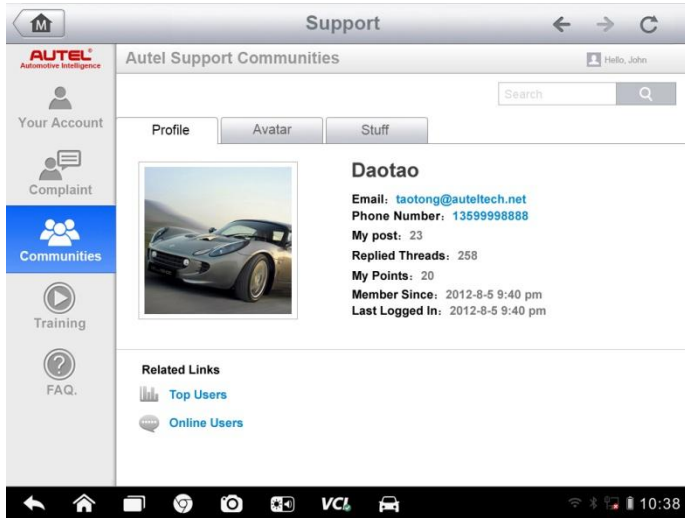

Figure 12-4 Sample User Profile Screen

- **Profile** – displays the user’s personal information and member status. The **Related links** allow you to check the Top Users (ranked according to their points and levels) in the communities, as well as to find out other online users.
- **Avatar** – allows you to select a image to set as your personal Avatar to be displayed in the communities.
- **Stuff** – displays all the discussions you’ve posted at various forums in the list.

12.6 Training Channels

The Training section provides quick links to Autel’s online video accounts. Select a video channel by the language to see all the available online tutorial videos from Autel, for various technical supports, such as product usage techniques and vehicle diagnostics practice, etc, may be available for your interests.

12.7 FAQ Database

The FAQ section provides you comprehensive and abundant references for all kinds of questions frequently asked and answered about the use of Autel's online member account, and shopping and payment procedures.

- **Account** – displays questions and answers about the use of Autel's online user account.
- **Shopping & Payment** – displays questions and answers about online product purchase and payment methods or procedures.

Chapter 13 Remote Program Operations

(Coming soon)

The Remote Program application configures the MaxiSys diagnostic device to perform as a PassThru programming interface, it allows remote supports from the computer of a third party to perform vehicle ECU flash reprogramming. This unique technology enables you to find professional support on vehicle reprogramming operation issues, at any time through the internet. Whether it is from Autel's technical support personnel or any professionals in this field, by using the Remote Program function, they are allowed to access and reprogram the test vehicle from anywhere, simply via the MaxiSys Diagnostic Platform via the Internet.

Chapter 14 Training Operations

The Training application provides and allows you to play various tutorial videos stored on the device. The stored training materials mainly consists of product usage tutorials and vehicle diagnostic training videos, all produced by top-notch technicians and product experts. The application also allows you to download or watch more associated videos online, by providing quick links to Autel's online video database.

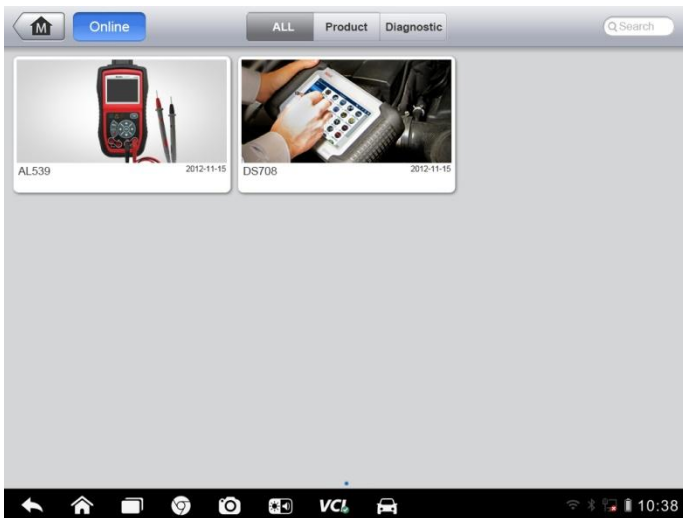

Figure 14-1 Sample Training Application Screen

1. **Navigation Buttons** – allows you to navigate the application interface.
 - Home Button – returns to the MaxiSys Job Menu
 - Online – opens the quick link page and provides access to Autel’s online video database
 - All – displays all available video files
 - Product – displays video files for product usage tutorial
 - Diagnostic – displays video files for vehicle diagnostic training class
2. **Main Section** – displays the available video files for watching.
 - **To play a video**
 1. Tap the **Support** application on the MaxiSys Job Menu. The Training application screen displays.
 2. Select a video file from the main section.
 3. Tap the **Play** button on the left side.
 4. Select a Player from the popup window if necessary. Now you can watch the video, it is played in full screen mode.

Chapter 15 Quick Link Operations

The Quick Link application provides you with convenient access to Autel's official website and many other well-known sites in automotive service, which offers you abundant information and resources, such as technical help, knowledge base, forums, training, and expertise consultations, etc.



Figure 15-1 Sample Quick Link Screen

➤ **To open a quick link**

1. Tap the **Quick Link** application on the MaxiSys Job Menu. The Quick Link application screen displays.
2. Select a website thumbnail from the main section. The Chrome browser is launched and the selected website is opened.
3. Now you can start exploring the website!

Chapter 16 Digital Inspection Operations

The Digital Inspection application configures the MaxiSys Diagnostic Device to operate as a digital video scope by simply connecting the tablet to an additional Imager head Cable. This function allows you to examine difficult-to-reach areas normally hidden from sight, with the ability to record digital still images and videos, which offers you an economical solution to inspect machinery, facilities, and infrastructure in a safe and quick way.



WARNINGS & IMPORTANTS:

Follow these instructions to reduce the risk of injury from electric shock, entanglement and other causes and prevent tool damage.

- Do not place the imager head and cable into anything or anywhere that may contain a live electric charge or moving parts, which increases the risk of electric shock or entanglement injuries.
- Do not use the imager head cable to modify surroundings, clear pathways or clogged areas.
- When inspection is completed, carefully withdraw the imager head and cable from the inspection area.
- The imager head cable were waterproof to a depth of 3m (10'), greater depths may cause leakage into the imager head cable and cause electric shock or damage the tool.
- The working temperature of the imager head is between 32 F (30 °C) and 113 F (45 °C).

Check-Ups:

- ✓ **FOR AUTOMOBILES:** Ensure the automobile is not running during inspection. Metal and liquid under the hood may be hot. Don't get oil or gas on the imager head.
- ✓ **FOR PIPES:** If you suspect a metal pipe could contain an electric charge, have a qualified electrician to check the pipe before using.
- ✓ **FOR WALLS:** For inspecting the inside walls, be sure to shut off the circuit breaker to the whole house before using the tool.
- ✓ **WORK AREA:** Ensure the work area has sufficient light.

16.1 Additional Accessories

The Imager head Cable and its fittings are the additional accessories. Both sizes (**8.5 mm and 5.5 mm**) of the imager head are optional and available for purchase along with the standard MaxiSys tool kit.

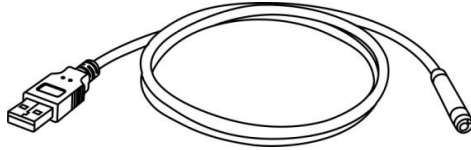

Figure 16-1 Imager Head Cable

Imager Head Cable – connects to the display tablet when performing Digital Inspections for image and video viewing.

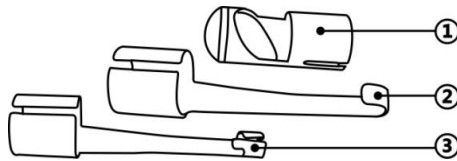

Figure 16-2 8.5mm Imager Head Accessories

1. **Magnet** – picks up small metal objects, such as dropped rings or screws
2. **Hook** – unclogs obstacles and picks up wires in the pipes or confined areas
3. **Mirror** – helps to look around corners and see the unreachable areas

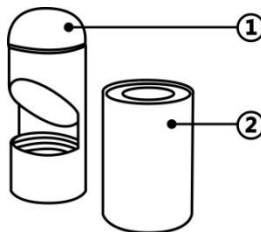

Figure 16-3 5.5mm Imager Head Accessories

1. **Mirror** – helps to look around corners and see the unreachable areas
2. **Magnet** - picks up small metal objects, such as dropped rings or screws

Accessory Assembly

For 8.5mm Imager Head

The three accessories, including the Magnet, Hook, and Mirror (*Figure 16-2*), can be attached to the Imager Head with the same manner described below:

1. Hold the accessory and the imager head.

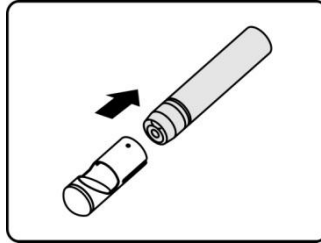

2. Slip the end of the accessory over the imager head and then fix the accessory.

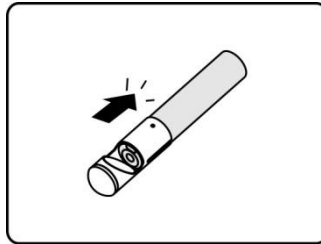

For 5.5mm Imager Head

The two accessories, including the Magnet and Mirror (*Figure 16-3*), can be attached to the Imager Head with the same manner described below:

1. Hold the accessory and the imager head.

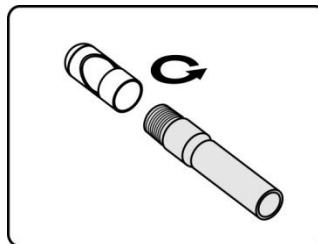

2. Screw the thread part of the accessory over the imager head to fix the accessory.

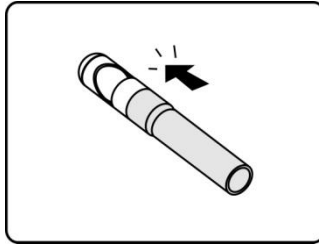

16.2 Operations

Before performing the Digital Inspection application, the Imager Head Cable must be connected to the MaxiSys display tablet through the USB port. Install the correct imager head accessories for use in the appropriate application.

NOTE: When in operation, the imager head cable can be bent into a certain shape. This may help you operate the cable into confined areas.

- **To take pictures using the Digital Inspection application**
 1. Connect the Imager Head Cable to the USB port on the top side of the MaxiSys Display Tablet.
 2. If not already done, power up the MaxiSys Display Tablet.
 3. Tap the **Digital Inspection** application on the MaxiSys Job Menu. The Digital Inspection application interface displays, showing a camera operating screen. The default camera is now the Imager head.
 4. Select the **camera** icon at the lower right corner to take photos.
 5. Focus the image to be captured in the view finder by adjusting and properly locating the imager head cable.
 6. Tap the blue circle on the operating screen. The view finder now shows the captured picture and auto-saves the taken photo.
 7. Tap the thumbnail image on the top right corner of the screen to view the stored image, slide the screen left and right to view the images

one by one.

8. Tap on the selected image and the edit toolbar instantly displays.
9. Tap the appropriate button to **share**, **delete**, or **edit** the image.
10. Tap the **Back** or **Home** button on the Navigation bar at the bottom of the screen to exit the Digital Inspection application.

➤ **To record a video using the Digital Inspection application**

1. Connect the Imager Head Cable to the USB port on the top side of the MaxiSys Display Tablet.
2. If not already done, power up the MaxiSys Display Tablet.
3. Tap the **Digital Inspection** application on the MaxiSys Job Menu. The Digital Inspection application interface displays, showing a camera operating screen. The default camera is now the Imager head.
4. Select the **video** icon at the lower right corner to record a video.
5. Properly locate the imager head cable to focus the inspection scene for recording.
6. Tap the red circle on the operating screen to start recording.
7. Tap the red circle again to stop recording. The recorded video is automatically saved to the system Gallery.
8. Tap the thumbnail image on the top right corner to review the recorded video.
9. Tap the **Play** button to play the video.
10. Tap on the selected video and the edit toolbar instantly displays.
11. Tap the appropriate button to **share**, **delete**, or **edit** the video.
12. Tap the **Back** or **Home** button on the Navigation bar at the bottom of the screen to exit the Digital Inspection application.

- To configure various settings for the work mode of the imager head. Tap the button at the bottom edge of the circle, and select each item to make appropriate adjustments.

For more tips and detailed information about the camera application, please refer to associated Android documentations.

Chapter 17 Scope Operations (Coming soon)

When use in conjunction with various leads, clips, and adapters the Scope application provides all the features needed for performing electrical and electronic circuit tests and for monitoring signal and circuit activity. This function offers you fast and accurate solution to vehicle electrical system diagnostics.

Chapter 18 Maintenance and Service

To ensure that the MaxiSys diagnostic tablet and the combined VCI unit perform at their optimum level, we advise that the product maintenance instructions covered in this section is read and followed.

18.1 Maintenance Instructions

The following shows how to maintain your devices, together with precautions to take.

- Use a soft cloth and alcohol or a mild window cleaner to clean the touch screen of the tablet.
- Do not use any abrasive cleansers, detergent, or automotive chemicals to the tablet.
- Maintain the devices in dry conditions and keep them within normal operating temperatures.
- Dry your hands before using the tablet. The touch screen of the tablet may not work if the touch screen is moist, or if you tap the touch screen with wet hands.
- Do not store the devices in humid, dusty or dirty areas.
- Check the housing, wiring, and connectors for dirt and damage before and after each use.
- At the end of each work day, wipe the device housing, wiring, and connectors clean with a damp cloth.
- Do not attempt to disassemble your tablet or the VCI unit.
- Do not drop or cause severe impact to the devices.
- Use only authorized battery chargers and accessories. Any malfunction or damage caused by the use of unauthorized battery charger and accessories will void the limited product warranty.
- Ensure that the battery charger does not come in contact with conductive objects.
- Do not use the tablet beside microwave ovens, cordless phones and some medical or scientific instruments to prevent signal interference.

18.2 Troubleshooting Checklist

A. When the display tablet does not work properly:

- Make sure the tablet has been registered online.
- Make sure the system software and diagnostic application software are properly updated.
- Make sure the tablet is connected to the Internet.
- Check all cables, connections, and indicators to see if the signal is being received.

B. When battery life is shorter than usual:

- This may happen when you are in an area with low signal strength. Turn off your device if it is not in use.

C. When you cannot turn on the tablet:

- Make sure the tablet is connected to a power source or the battery is charged.

D. When you are unable to charge the tablet:

- Your charger maybe out of order. Contact your nearest dealer.
- You may be attempting to use the device in an overly hot/cold temperature. Try changing the charging environment.
- Your device may have not been connected to the charger properly. Check the connector.

NOTE: If your problems persist, please contact Autel's technical support personnel or your local selling agent.

18.3 About Battery Usage

Your tablet is powered by a built-in Lithium-ion Polymer battery. This means that, unlike other forms of battery technology, you can recharge your battery while some charge remains without reducing your tablet's autonomy due to the "battery memory effect" inherent in those technologies.



DANGER: The built-in Lithium-ion Polymer battery is factory replaceable only; incorrect replacement or tampering with the battery pack may cause an explosion.

- Do not use a damaged battery charger.
- Do not disassemble or open crush, bend or deform, puncture or shred.
- Do not modify or remanufacture, attempt to insert foreign objects into the battery, expose to fire, explosion or other hazard.
- Make sure to use the charger and USB cables only that come together in the package. If you use the other charger and USB cables, you might incur malfunction or failure of the device.
- Only use the charging device that has been qualified with device per the standard. Use of an unqualified battery or charger may present a risk of fire, explosion, leakage, or other hazard.
- Avoid dropping the tablet. If the tablet is dropped, especially on a hard surface, and the user suspects damage, take it to a service center for inspection.
- The closer you are to your network's base station, the longer your tablet usage time because less battery power is consumed for the connection.
- The battery recharging time varies depending on the remaining battery capacity.
- Battery life inevitably shortens over time.
- Since over charging may shorten battery life, remove the tablet from its charger once it is fully charged. Unplug the charger, once charging is complete. Leaving the tablet in hot or cold places, especially inside a car in summer or winter, may reduce the capacity and life of the battery. Always keep the battery within normal temperatures.

18.4 Service Procedures

This section introduces information for technical support, repair service, and application for replacement or optional parts.

Technical Support

If you have any question or problem on the operation of the product, please:

- Call 1-877-288-3587/1-877-AUTELUS (North America), or 0086-755-86147779 (China).

- Contact the local distributor or agent.
- Visit our website <http://pro.auteltech.com> or <http://www.maxidas.com>.

Repair Service

If it becomes necessary to return your device for repair, please download the repair service form from <http://www.maxidas.com>, and fill in the form. The following information must be included:

- Contact name
- Return address
- Telephone number
- Product name
- Complete description of the problem
- Proof-of-purchase for warranty repairs
- Preferred method of payment for non-warranty repairs

NOTE: For non-warranty repairs, payment can be made with Visa, Master Card, or with approved credit terms.

Send the device to your local agent, or to the below address:

Rm. 106, 107, 109, 114, SZICC Bldg.,
Chaguang Road Southside, Xili Town,
Nanshan District, Shenzhen
518055, P.R. China

Other Services

You can purchase the optional accessories directly from Autel's authorized tool suppliers, and/or your local distributor or agent.

Your purchase order should include the following information:

- Contact information
- Product or part name
- Item description
- Purchase quantity

Chapter 19 Warranty

12-Month Limited Warranty

Autel Intelligent Technology Co., Ltd (the Company) warrants to the original retail purchaser of this MaxiSys Diagnostic Device, that should this product or any part thereof during normal consumer usage and conditions, be proven defective in material or workmanship that results in product failure within twelve (12) months period from the date of delivery, such defect(s) will be repaired, or replaced (with new or rebuilt parts) with Proof of Purchase, at the Company's option, without charge for parts or labor directly related to the defect(s).

The Company shall not be liable for any incidental or consequential damages arising from the use, misuse, or mounting of the device. Some states do not allow limitation on how long an implied warranty lasts, so the above limitations may not apply to you.

This warranty does not apply to:

- a) Products subjected to abnormal use or conditions, accident, mishandling, neglect, unauthorized alteration, misuse, improper installation or repair or improper storage;
- b) Products whose mechanical serial number or electronic serial number has been removed, altered or defaced;
- c) Damage from exposure to excessive temperatures or extreme environmental conditions;
- d) Damage resulting from connection to, or use of any accessory or other product not approved or authorized by the Company;
- e) Defects in appearance, cosmetic, decorative or structural items such as framing and non operative parts.
- f) Products damaged from external causes such as fire, dirt, sand, battery leakage, blown fuse, theft or improper usage of any electrical source.

IMPORTANT: All contents of the product may be deleted during the process of repair. You should create a back-up copy of any contents of your product before delivering the product for warranty service.

FCC Statement

This equipment has been tested and found to comply with the limits for a Class B digital device, pursuant to Part 15 of the FCC Rules. These limits are designed to provide reasonable protection against harmful interference in a residential installation. This equipment generates uses and can radiate radio frequency energy and, if not installed and used in accordance with the instructions, may cause harmful interference to radio communications. However, there is no guarantee that interference will not occur in a particular installation. If this equipment does cause harmful interference to radio or television reception, which can be determined by turning the equipment off and on, the user is encouraged to try to correct the interference by one or more of the following measures:

- Reorient or relocate the receiving antenna.
- Increase the separation between the equipment and receiver.
- Connect the equipment into an outlet on a circuit different from that to which the receiver is connected.
- Consult the dealer or an experienced radio/TV technician for help.

This device complies with part 15 of the FCC Rules. Operation is subject to the following two conditions:

(1) This device may not cause harmful interference, and (2) this device must accept any interference received, including interference that may cause undesired operation.

Changes or modifications not expressly approved by the party responsible for compliance could void the user's authority to operate the equipment.

The antenna(s) used for the transmitter of Bluetooth Diagnostic Interface must be installed to provide a separation distance of at least 20 cm from all persons and must not be co-located or operating in conjunction with any other antenna or transmitter.

AUTEL[®]

Autel Intelligent Technology Co., Ltd.

All Rights Reserved

www.auteltech.com