

---

## **Trademarks**

Autel<sup>®</sup>, Maxaero<sup>™</sup>, X-Memo<sup>™</sup> and X-Star<sup>™</sup> are trademarks of Autel Aerial Technology Co., Ltd., registered in China, the United States and other countries. All other marks are trademarks or registered trademarks of their respective holders.

## **Copyright Information**

No part of this manual may be reproduced, stored in a retrieval system or transmitted, in any form or by any means, electronic, mechanical, photocopying, recording, or otherwise, without the prior written permission of Maxaero.

## **Disclaimer of Warranties and Limitation of Liabilities**

All information, specifications and illustrations in this manual are based on the latest information available at the time of printing. Maxaero reserves the right to make changes at any time without notice. While information of this manual has been carefully checked for accuracy, no guarantee is given to the completeness and correctness of the contents, including but not limited to the product specifications, functions, and illustrations.

Use the products within the limits permitted by local laws and regulations. In purchasing the products, the buyer/user agrees to bear full responsibilities of the results of using this product. Maxaero will not be liable for any direct damages or for any special, incidental, or indirect damages or for any economic consequential damages (including lost profits).

---

**IMPORTANT:** Before operating or maintaining this unit, please read this manual carefully, paying extra attention to the safety warnings and precautions.

---

---

## Safety Information

For your own safety and the safety of others, and to prevent damage to the product and other properties, it is important that the instructions and all safety information presented throughout the product manuals be read and understood by all persons operating, or coming into contact with, the product.

---

**IMPORTANT:** This product is not intended for use by children without adult supervision. Do not use with incompatible components or alter this product in any way inconsistent with the instructions provided by Maxaero.

---

- Fly with an experienced pilot for the first flight is strongly recommended.
- Fly in open and safe area; keep away from people and moving vehicles especially when taking-off and landing.
- Remove the batteries before assembly or when not in use.
- Keep away from the moving and powered parts especially rotating propellers.
- Remove all propellers during configuration and setup.
- Keep the small or electrical parts out of the reach of children.
- Keep all the parts dry and clean.
- Keep away from heat sources or humid and hostile environments.
- Make a thorough preflight check before each flight.
- Remove the propellers when testing the motors' operation.
- Make sure the batteries of all devices (aircraft, remote controller, camera, and mobile) are fully charged.
- Make sure the failsafe function of your remote controller is enabled before take-off.
- Do not fly in GPS mode when less than 6 satellite signals are received.
- Keep away from electromagnetic interference.
- Use with only authorized accessories approved or provided by Maxaero.

---

## About Battery Usage

The product is powered by a built-in Lithium-ion Polymer battery.

LiPo/Li-Ion batteries can be extremely hazardous and special attention is required during usage. Read and follow all safety messages and instructions presented to avoid personal injuries or property damages.

---

**DANGER:** The built-in Lithium-ion Polymer battery is factory replaceable only; incorrect replacement or tampering with the battery pack may cause an explosion.

---

- Do not use a damaged battery charger.
- Do not disassemble or open, crush, bend or deform, puncture or shred.
- Do not modify or remanufacture, attempt to insert foreign objects into the battery, expose the battery to fire, explosion or other hazards.
- Disconnect and remove the Li-Po battery from the aircraft after use to prevent trickle discharge. During storage, make sure the battery charge does not fall below 3V.
- Stop using or charging the battery immediately whenever the battery starts to swell, smoke or leak.
- Only use the charging device that has been qualified with device per the standard. Use of an unqualified battery or charger may present a risk of fire, explosion, leakage, or other hazards.
- The heavier the payload, the shorter the flight time will be as more battery power may be consumed.
- The battery recharging time varies depending on the remaining battery capacity.
- Battery life inevitably shortens over time.
- Since over charging may shorten battery life, remove the battery or the device from its charger once it is fully charged. Unplug the charger once charging is complete.

- 
- Leaving the product in extreme environments may reduce the capacity and life of the battery. Always keep the battery within normal temperatures.
  - Completely discharge the battery prior to disposal.
  - Dispose of the battery properly.

**For Services and Support:**

 <http://www.maxaero.com>

 0086-755-86147779 (China)

 Support@maxaero.com

Or contact your local selling agent for technical assistance in all other markets.

---

# Contents

<b>DISCLAIMER OF WARRANTIES AND LIMITATION OF LIABILITIES .....</b>	<b>I</b>
<b>SAFETY INFORMATION.....</b>	<b>II</b>
<b>ABOUT BATTERY USAGE.....</b>	<b>III</b>
<b>CHAPTER 1 USING THIS MANUAL.....</b>	<b>1</b>
1.1 CONVENTIONS.....	1
1.1.1 BOLD TEXT.....	1
1.1.2 TERMINOLOGY .....	1
1.1.3 NOTES AND IMPORTANT MESSAGES .....	1
1.1.4 HYPERLINKS .....	2
1.1.5 PROCEDURES .....	2
<b>CHAPTER 2 GENERAL INTRODUCTION .....</b>	<b>3</b>
2.1 IN THE BOX .....	3
2.2 AIRCRAFT .....	7
2.2.1 FUNCTIONAL DESCRIPTION .....	7
2.2.2 BUILT-IN SMART FLIGHT SYSTEM .....	9
2.2.3 FLIGHT LED INDICATOR LIGHT .....	11
2.2.4 AIRCRAFT BATTERY .....	12
2.2.5 3-AXIS CAMERA GIMBAL .....	16
2.2.6 CAMERA .....	18
2.3 REMOTE CONTROLLER .....	20
2.3.1 FUNCTIONAL DESCRIPTION .....	21
2.3.2 REMOTE CONTROLLER INDICATOR LIGHTS.....	24
2.3.3 TECHNICAL SPECIFICATIONS.....	26
<b>CHAPTER 3 PRE/POST-FLIGHT OPERATIONS .....</b>	<b>27</b>
3.1 PREPARING AIRCRAFT .....	27
3.1.1 REMOVING GIMBAL LOCK .....	27
3.1.2 INSTALLING PROPELLERS .....	28
3.1.3 CHARGING FLIGHT BATTERY .....	29
3.1.4 INSTALLING AND REMOVING THE BATTERY .....	30
3.1.5 MOUNTING THE CAMERA .....	31

---

3.2	PREPARING REMOTE CONTROLLER .....	32
3.2.1	RE-PAIRING REMOTE CONTROLLER.....	33
3.3	PREPARING MOBILE DEVICE.....	34
3.3.1	INSTALLING MOBILE APP .....	35
3.3.2	REGISTERING USER ACCOUNT .....	35
3.3.3	ESTABLISHING X-STAR WIFI NETWORK.....	35
3.3.4	RE-PAIRING X-STAR WIFI NETWORK .....	36
3.4	INSTALLING PC AID SUITE .....	38
3.4.1	REGISTER PC AID ACCOUNT .....	38
<b>CHAPTER 4</b>	<b>FLIGHT OPERATIONS.....</b>	<b>40</b>
4.1	PREFLIGHT CHECKLIST .....	40
4.2	CALIBRATING COMPASS .....	41
4.3	REMOTE CONTROLLER AND FLIGHT OPERATIONS .....	43
4.3.1	MOTOR START-UP AND TAKE-OFF .....	43
4.3.2	FLIGHT ATTITUDE CONTROLS.....	44
4.3.3	LANDING AND MOTOR SHUT-DOWN .....	47
4.3.4	OPERATIONS OF SMART FLIGHT FEATURES.....	49
4.4	X-STAR MOBILE APP OPERATIONS .....	53
4.4.1	X-STAR MOBILE APP MAIN MENU .....	53
4.4.2	CAMERA OPERATIONS .....	55
4.4.3	GROUND STATION OPERATIONS .....	61
4.4.4	CONFIGURATION OPERATIONS .....	67
4.4.5	SETTINGS OPERATIONS .....	77
4.5	PC AID OPERATIONS .....	79
<b>CHAPTER 5</b>	<b>MAINTENANCE AND SERVICE .....</b>	<b>82</b>
5.1	MAINTENANCE INSTRUCTIONS.....	82
5.2	TROUBLESHOOTING CHECKLIST .....	83
5.3	SERVICE PROCEDURES.....	85
<b>CHAPTER 6</b>	<b>WARRANTY .....</b>	<b>87</b>

---

## Chapter 1 Using This Manual

This manual contains product usage instructions.

Some illustrations shown in this manual may contain optional modules or accessories that are not included on your system. Contact your sales representative for availability of other modules and optional accessories.

### 1.1 Conventions

The following conventions are used.

#### 1.1.1 Bold Text

Bold emphasis is used to highlight selectable items such as buttons and menu options.

Example:

- Tap **OK**.

#### 1.1.2 Terminology

The term “select” means highlighting a button or menu item and tapping it to confirm the selection.

#### 1.1.3 Notes and Important Messages

The following messages are used.

##### Notes

A **NOTE** provides helpful information such as additional explanations, tips, and comments.

##### Important

**IMPORTANT** indicates a situation which, if not avoided, may result in property damages or personal injuries.

---

### 1.1.4 Hyperlinks

Hyperlinks, or links, that take you to other related articles, procedures, and illustrations are available in electronic documents. Blue colored text indicates a selectable hyperlink.

### 1.1.5 Procedures

An arrow icon indicates a procedure.

Example:

- To use the camera:
  - 1 Tap the **Camera** button. The camera screen opens.
  - 2 Focus the image to be captured in the view finder.
  - 3 Tap the blue circle. The view finder now shows the captured picture and auto-saves the taken photo.



---

## Chapter 2 General Introduction

The X-Star is the new generation of smart unmanned aircraft system. It is extremely easy to fly and reliable. Featuring the advanced built-in Smart Flight System, a high-performance remote control, combined with a powerful mobile app, the X-Star system allows safe and stable flight maneuvers both manually and automatically. The stabilized 3-axis camera gimbal offers ideal solutions for smooth aerial photographing and video recording, making the system incredibly versatile and powerful.

This manual describes the construction and operation of the product, and how it works to deliver flight maneuvers for ideal aerial photographing solutions.

### 2.1 In The Box

The complete X-Star ST1 standard package comes with the following items. Before using the system, check if everything is included.

---

**NOTE:** The package may or may not contain the camera and the camera accessories kit depending on the Gimbal system purchased.

---

**Table 2-1** Package Contents



Image	Qty.	Description
	X1	<b>Aircraft</b> Integrated with a 3-axis Gimbal and a Camera (optional)
	X4 Pair	<b>Propeller</b> 4 with red nut, 4 with white/black nut
	X1	<b>8GB MicroSD Card</b> Inserted in the Camera MicroSD card slot





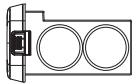
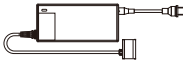



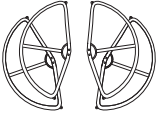





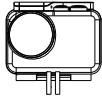











Image	Qty.	Description
	X1	<b>Gimbal Lock</b> Protects the Camera Gimbal when not in use
	X1	<b>Lens Cap</b> Protects camera lens from dust and scratches
	X1	<b>Gimbal Camera Securing Bracket</b> Secures the camera to the mount
	X1	<b>Remote Controller</b> Phone holder and 5000mAh Li-Ion battery included
	X1	<b>Aircraft Battery</b> 6400mAh Rechargeable Li-Po battery Provides $\geq 25$ minutes of flight time if fully charged.
	X1	<b>Aircraft Battery Charger</b> Connects the Aircraft Battery to the external power port for AC/DC power supply
	X1	<b>Micro-USB Cable</b> <ul style="list-style-type: none"> <li>• Connects the Remote Control to the USB Power Adapter for power supply;</li> <li>• Connects the Aircraft or the Remote Control to the PC for firmware update or configurations;</li> <li>• Connects the Camera Gimbal to the PC for camera file transfer.</li> </ul>
	X1	<b>USB Power Adapter</b> Connects to the external power port and provides power supply to the Remote Control through the Micro-USB Cable.

Image	Qty.	Description
	X3	<b>Manuals</b> <ul style="list-style-type: none"> <li>• User Manual</li> <li>• X-Star ST1 Quick Start Guide</li> <li>• Camera Mount Quick Start Guide (for camera attached gimbals)</li> </ul>
	X1	<b>CD</b> Includes PC Aid Program and User Manual, etc.
	Optional Acc.	<b>Propeller Guards</b> Surround the propellers and protect them from damage. (4 in 1 set)

#### Aircraft Maintenance Kit

Image	Qty.	Description
	X2	<b>Indication Stickers</b> Helps pilots to identify the front side of the aircraft.
	X2	<b>Anti-drop Lock Pins</b> Fix the Camera Gimbal to the mounting rack connected to the aircraft to avoid dropping. 2 pins mounted on deliver; 2 extra supplied for maintenance use
	X4	<b>Vibration Absorber</b> Fixed in between the gimbal's mounting rack and the Gimbal to reduce vibrations and avoid mechanical damage.
	X11	<b>Spare Screws</b> M3X5 (6pcs); M3X8 (5pcs)
	X4	<b>Rubber Pad</b> Stick to the 4 corners at the bottom of the landing gear to support the aircraft when it is on the ground, and when it is landing or taking off.

### Camera Accessories Kit

Image	Qty.	Description
	X1	<b>Waterproof Housing</b> Allows underwater photographing.
	X2	<b>Backdoors</b> <ul style="list-style-type: none"> <li>• Opened (without cover, not waterproof)</li> <li>• Covered (with touchable screen protector)</li> </ul>
	X1	<b>Camera Battery</b> 940mAh Rechargeable Li-Po Battery installed on delivery
	X1	<b>Flat Mount</b>
	X1	<b>Curved Mount</b>
	X2	<b>Short Connectors</b>
	X1	<b>Long Connector</b>
	X1	<b>90° Rotate Connector (long)</b>
	X1	<b>90° Rotate Connector (short)</b>
	X1	<b>Connecting Screw (long)</b>
	X2	<b>Connecting Screws (short)</b>
	X1	<b>Fixing Rubber</b> Prevents the Rotate Connector from slipping off.
	X1	<b>Mini USB Cable</b> Connects the Camera to the PC for file transfer.

---

## 2.2 Aircraft

The X-Star aircraft is a quadcopter with an integrated stabilized camera gimbal. The camera may or may not be supplied depending on the gimbal model purchased. The Micro-USB port on the aircraft supports convenient connection that allows easy flight configuration and system update through the PC Aid Software.

### 2.2.1 Functional Description

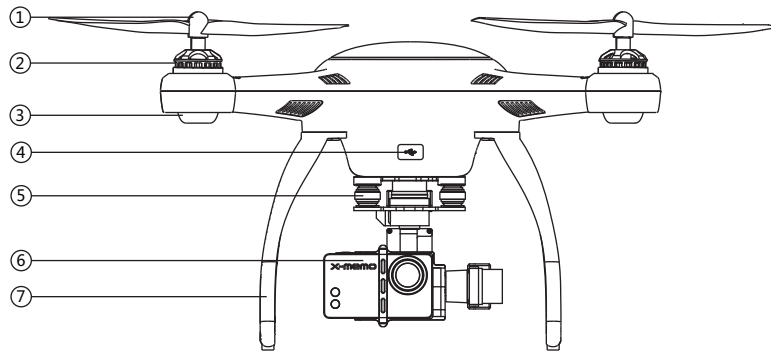

**Figure 2-1** Front Side

1. Propeller – 9.4 x 4.3 inch
2. Motor
3. Front LED Indicator Light – *helps to identify the aircraft nose*
4. Micro-USB Port – *allows communication between the Smart Flight System and the PC Aid program through USB connection*
5. 3-axis Camera Gimbal
6. Camera
7. Front Sticker – *helps to identify the aircraft nose*

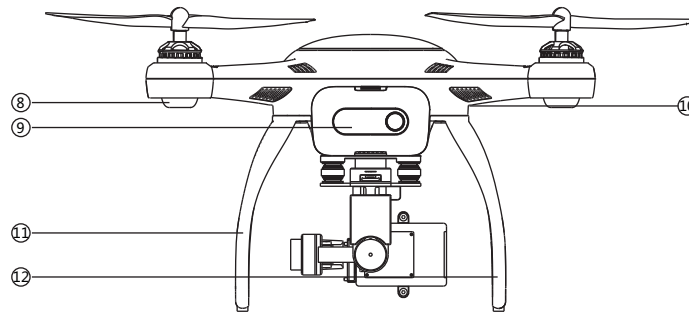

**Figure 2-2 Rear Side**

- 8. Rear LED Indicator Light – *indicates flight status*
- 9. Aircraft Battery
- 10. RC Pairing Button – *prepares the aircraft to perform pairing with the Remote Control, see 3.2.1 Re-pairing Remote Controller on page 33 for detailed instructions*
- 11. Landing Gear
- 12. Compass

## Aircraft Specifications

**Table 2-2 Aircraft Specifications**

Item	Descriptions
Max. Payload	0.8kg
Hover Precision	Horizontal: $\pm 2\text{m}$ ; Vertical: $\pm 1\text{m}$ ;
Max. Yaw Rate	180°/s
Max. Inclination Angle	GPS Mode: 30°; ATTI Mode: 30°
Max. Ascent/Descent Speed	Ascent: 6m/s; Descent: 2m/s
Max. Cruising Speed	12m/s
Diagonal Wheelbase	352mm

Item	Descriptions
Propeller Size	9.4"x4.3"
WiFi Frequency	2.4GHz
Receiver Frequency	5.8GHz
Flight Modes	<ul style="list-style-type: none"> <li>• GPS</li> <li>• IOC</li> <li>• ATTI</li> <li>• Waypoint</li> </ul>
Operating Environment Temperature	0°C~50°C (32°F~122°F)
Storage Temperature	0°C~45°C (32°F~113°F)
Weight (Battery & Propellers included)	1.1kg

### 2.2.2 Built-in Smart Flight System

The X-Star features the Built-in Smart Flight System which enables autopilot flight control that provides great ease of use and stability. The Smart Flight System consists of various modules such as the GPS receiver, the Compass and the Inertial Measurement Unit (IMU). It works as the central computer of the aircraft and supports various functions such as Intelligent Orientation Control (IOC), Go Home, and Failsafe, etc.

**Table 2-3** *Smart Flight System Modules*

Module	Descriptions
IMU	An electronic device consists of a gyroscope, accelerometer and magnetometer that measures flight velocity, gravitational force and orientation.
Compass	Reads geomagnetic information and assists the GPS receiver for accurate position calculation.
GPS Receiver	Receives GPS signals and determines the latitude and longitude of the aircraft location.

**Table 2-4 Smart Flight System Functions**

Function	Descriptions
IOC	Configures the aircraft to fly in the direction relative to the home point or consistent to the initial aircraft orientation, instead of its nose and tail.
Go Home	Commands the aircraft to return to and land on the specified home point.
Failsafe	Enables the aircraft to take automatic protection measure when communication with the remote control is lost, to prevent damage or injuries.

**NOTE:** A home point is usually memorized by the system each time as the point where the aircraft takes off. The home point can also be repositioned during flight. See [4.3.4 Operations of Smart Flight Features](#) on page 49 for details.

**Table 2-5 Supported Flight Modes**

Flight Modes	Descriptions
GPS Mode	Stabilizes and holds the aircraft in position on stick release when activated (requires at least 6 GPS satellite signals), which offers more stable and smooth flight maneuvers. It allows the safety features including Go Home, IOC and Failsafe for safer flight experiences.
ATTI Mode	Stabilizes and holds the aircraft to the altitude on stick release. The ATTI mode provides more agility in flight controls with attitude and speed mixture. It allows the safety features including Go Home, IOC and Failsafe for safer flight experiences.
Manual Mode	Provides freer and more agile flight maneuvers depending on 100% mechanical driving by controls of the command sticks. This mode is only recommended for experienced pilots, and is disabled by default. It can be activated through flight configurations with the PC Aid or X-Star Mobile App.



### 2.2.3 Flight LED Indicator Light

The LED Indicator Lights on the aircraft can be found at both the front and rear sides. The Front Indicators are mainly used for helping pilots to identify the position of the aircraft nose, and the Rear Indicators are used for showing the current flight status of the aircraft.

The LED Indicator Lights will light up when the aircraft is turned on. The table below describes the definitions of the LED Indicator Light status.

---

● - Indicates solid light;

○ – Indicates flashing light;

R – Indicates red colored light;

G – Indicates green colored light;

Y – Indicates yellow colored light

Example: “R-●” stands for **RED SOLID** light.

---

**Table 2-6** *Definitions of Flight LED Indicator Light Status*

LED Indicator Status	Descriptions
R-● (Front LEDs)	Light up when the motors start spinning after the aircraft is powered on, indicating the position of the aircraft nose.
G-O (Rear LEDs)	Displayed when in GPS Flight Mode. This mode can be activated only when more than 6 GPS satellites are found.
Y-O (Rear LEDs)	Displayed when in non-GPS Flight mode, or when less than 6 GPS satellites are found.
R-O-Slow (Rear LEDs)	Displayed when communication with the remote controller is lost.

LED Indicator Status	Descriptions
<b>R-O-Quick</b> (Rear LEDs)	Light up when battery voltage is less than 20%.
<b>Y-O</b> (Front & Rear LEDs)	Indicates compass calibration is required. See <a href="#">4.2 Calibrating Compass</a> on page 41 for detailed instructions.
<b>Y-●</b> (Rear LEDs)	Displayed during the 1 <sup>st</sup> step of compass calibration.
<b>G-●</b> (Rear LEDs)	Displayed during the 2 <sup>nd</sup> step of compass calibration.
<b>R-O</b> (Front & Rear LEDs)	Indicates hardware problems possibly caused by: <ul style="list-style-type: none"> <li>● IMU deviation or abnormal</li> <li>● Compass error</li> <li>● Remote Controller recalibration required</li> </ul> See <a href="#">5.2 Troubleshooting Checklist</a> on page 83 for detailed information.

## 2.2.4 Aircraft Battery

The Aircraft Battery is a rechargeable Li-Po Battery with the capacity of 6400mAh specially designed for the X-Star aircraft. It can only be charged by the charger supplied with the X-Star package, and can provide sufficient power for about 25 minutes of continuous flight if fully charged.

The Aircraft Battery features several smart functionalities for charge-discharge management that improves the battery's longevity.

**Table 2-7 Aircraft Battery Features**

<b>Feature</b>	<b>Descriptions</b>
Balancing	Balances the voltage of each battery cell to prevent overcharging or over-discharging.
Communication	Retrieves and transfers battery info, including battery level, current, voltage, battery life, and temperature to the aircraft and the controller.
Charging Temperature Detection	Stops battery charging when environment temperature is out of allowed range.
Low Battery Protection	Activates alarm when battery level is less than 20%.
LED Capacity Indicator	Indicates current battery level.
Overcharging & Over-discharging Protection	<ul style="list-style-type: none"><li>• Automatically stops charging when battery voltage reaches 12.8V to prevent damage.</li><li>• Automatically stops discharging when battery voltage reaches 8.4V to prevent damage.</li></ul>
Short Circuit Protection	<ul style="list-style-type: none"><li>• Cuts off power supply when a short circuit occurs to prevent damage.</li><li>• All LED lights on the battery front panel will flash green when a short circuit is detected.</li></ul>
Power Saving	Turns the battery off automatically after 10 minutes of inactivity.

## Aircraft Battery Specifications

**Table 2-8** Aircraft Battery Specifications

Item	Descriptions
Battery Type	Rechargeable Li-Po Battery
Capacity	6400mAh
Battery Voltage	11.1V
Charging Environment Temperature	0°C~40°C (32°F~104°F)
Discharging Environment Temperature	-20°C~60°C (-4°F~140°F)
Storage Temperature & Humidity	Temp: -10°C~45°C (14°F~113°F); Humidity: 5~70%

### Functional Descriptions

The Aircraft Battery front panel contains 4 LED Capacity Indicator Lights and 1 Power Button.

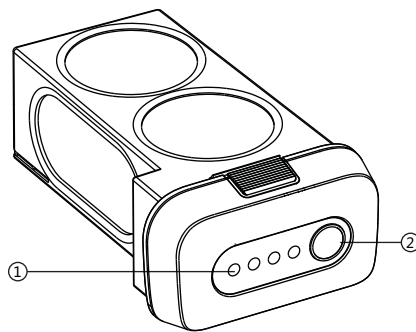

**Figure 2-3** Aircraft Battery

1. Capacity Indicator Lights
2. Power Button – allows you to check the battery level and turn on/off the battery
  - A. To turn on the battery and power up the aircraft, long press the Power Button for 3 seconds. The Capacity Indicator Lights will illuminate and indicate the current battery level. (See [Table 2-9](#) on page 15 for details.)
  - B. To turn off the battery, long press the Power Button for 3 seconds.
  - C. To check the current battery level when the battery is powered off, short press the Power Button once, and the Capacity Indicator Lights will illuminate and indicate the current battery level.

The table below describes the specific battery levels indicated by the Capacity Indicator Lights during discharging process.

**Table 2-9** Capacity Indicator Status while Discharging

● - Indicates solid green light; ○- Indicates flashing green light

Indicator Status	Battery Level
● ● ● ●	90%~100%
● ● ● ○	75%~89%
● ● ●	60%~75%
● ● ○	50%~60%
● ●	40%~50%
● ○	25%~40%
●	15%~25%
○	0%~15%

See [3.1.3 Charging Flight Battery](#) on page 29 for more details.

### 2.2.5 3-axis Camera Gimbal

The 3-axis Camera Gimbal mounted to the aircraft is specially designed to allow smooth aerial photography to minimize camera vibration or shake.

It is powered through the Aircraft Battery, and therefore it is turned on at the same time with the aircraft. A self-test is performed each time the Gimbal starts up.

The X-Star system is compatible with more than one gimbal model. Depending on the specific gimbal model purchased, the gimbal may or may not have a camera mounted, and the camera, if supplied, may or may not be detachable.

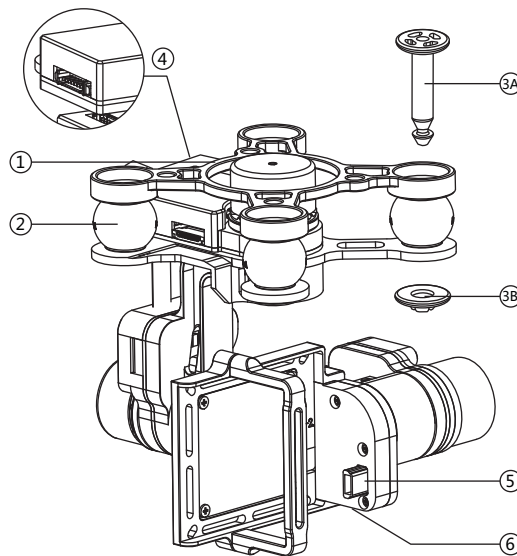

Figure 2-4 Standard 3-axis Camera Gimbal Sample

1. Mounting Rack
2. Vibration Absorber
3. Anti-drop Lock Pin
  - A. Press the pin through the hole at the corner of the gimbal's mounting rack with the Vibration Absorber in between;
  - B. Press the stud from the bottom up to lock the pin.
4. Aircraft Communication Port
5. Camera Connector
6. Micro-USB Port – connects to the PC using the Micro-USB cable supplied for camera file transfer. Do not disconnect the camera from the gimbal while transferring.

### Camera Gimbal Specifications

**Table 2-10** *Camera Gimbal Specifications*

Item	Descriptions
Operating Current	340mA@12V (Camera Off) 600mA@12V (Camera On)
Operating Environment Temperature	0°C~45°C
Control Accuracy	Tilt/Roll: $\pm 0.02^\circ$ Yaw: $\pm 0.03^\circ$
Controllable Range	Pitch: $0^\circ \sim 90^\circ$ ( $-130^\circ \sim +45^\circ$ )
Maximum Angular Velocity	$90^\circ/\text{s}$ ( $\pm 150^\circ/\text{S}$ )

**NOTE:** The Camera Gimbal comes with a gimbal lock attached which protects the gimbal from incidental rotation to avoid damage. Remove the clamp before powering up the aircraft (see [Figure 3-1](#) on page 27).

---

**The 3-axis Camera Gimbal for X-Star supports 2 working modes:**

1. FPV Mode – synchronizes the camera gimbal movements with the aircraft to provide a real time video piloting experience from a first-person view.
2. Non-FPV Mode – enables stabilized camera tilting control for creative aerial photography.

See [4.4.4 Configuration Operations](#) on page 67 for detailed configuration instructions.

### 2.2.6 Camera

The Camera mounted to the Aircraft is stabilized by the 3-axis Camera Gimbal. Depending on the gimbal's working mode applied, it enables both real time FPV piloting control and smooth aerial photographing and video recording based on the pilot's needs. See [3-axis Camera Gimbal](#) on page 16 for more information.

The Camera has a built-in Li-Po battery, which can be charged either by the Aircraft Battery when mounted to the gimbal on the aircraft, or by connecting to the PC using the Mini USB Cable supplied.

Turn on the camera before powering up the aircraft.

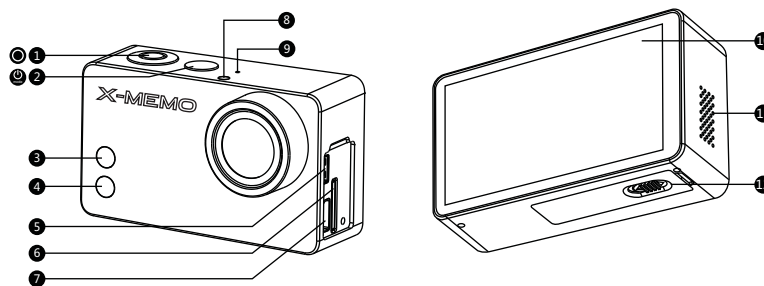

**Figure 2-5** Camera 6-Side View



- |                             |                              |
|-----------------------------|------------------------------|
| 1. Shutter/Select Button    | 2. Power/Mode Button         |
| 3. WiFi Status Light (blue) | 4. Camera Status Light (red) |
| 5. Micro HDMI Port          | 6. MicroSD Card Slot         |
| 7. Mini USB Port            | 8. LED Status Light          |
| 9. Microphone               | 10. Touch Screen             |
| 11. Audio Speaker           | 12. Battery Compartment Lock |

**Table 2-11** Camera Functional Descriptions

Name	Description
1. Shutter/Select Button	Press this button to: A. Take photos or videos B. Make selections on menus
2. Power/Mode Button	A. Press this button once to turn on the camera. B. Press and hold for 3 seconds to turn off the camera. C. When the camera is powered on, pressing this button allows you to switch among the camera <b>Modes</b> , the <b>Playback</b> and the <b>Setting</b> options in sequence.
3. WiFi Status Light (blue)	Indicates the WiFi communication status.
4. Camera Status Light (red)	Indicates the working status of the camera when taking photos or videos.
5. Micro HDMI Port	Connects the camera to a compatible computer monitor, digital television, or video projector for high definition video file transfer.
6. MicroSD Card Slot	Stores camera files.
7. Mini USB Port	Connects to and communicates with the gimbal or the PC for file transfer.
8. LED Status Light	Synchronizes with the Camera and WiFi Status lights for convenient identification.

Name	Description
9. Microphone	Records sound when taking videos.
10. Touch Screen	Works as the display monitor featuring intuitive touch control.
11. Audio Speaker	Makes alert sounds and plays audios.
12. Battery Compartment Lock	Locks or unlocks the Battery Compartment. Contains a 940mAh rechargeable Li-Po battery.

**NOTE:** The camera lens is covered by a lens cap on delivery to protect the camera lens from dust and scratches. Remove the lens cap before use.

### Camera Specifications

**Table 2-12** *Camera Specifications*

Item	Descriptions
Operating Environment Temperature	-10°C~50°C (14°F~122°F)
Effective Pixels	12MP
HD Recording Resolution	1080P/60fps
Max. Recording Field of View	160°

**NOTE:** Refer to the supplied camera manual for more operation instructions.

## 2.3 Remote Controller

The X-Star Remote Controller enables wireless communication with the Aircraft through a 5.8GHz radio frequency band. The maximum working range of the Remote Controller through RF signal in an open area is about 400m when set as CE compliant, or about 800m when set as FCC compliant.

The built-in 2.4GHz WiFi module on the Remote Controller allows self-generated WiFi network connection for real time flight and video data transmission between the aircraft and the mobile device enabling convenient controls of aerial photographing and remote piloting.

**NOTE:** The X-Star WiFi Network is only established when the aircraft, the Remote Controller and the mobile device are properly connected through WiFi connection. See [3.3.3 Establishing X-Star WiFi Network](#) on page 35 for detailed instructions.

### 2.3.1 Functional Description

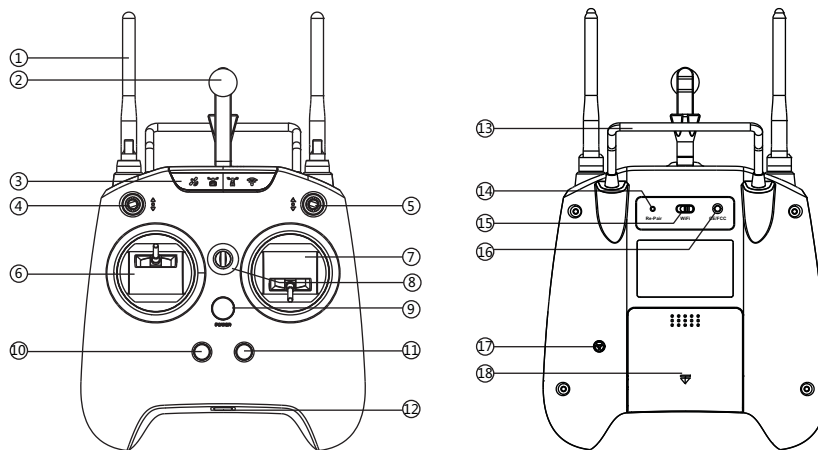

**Figure 2-6** Remote Controller Front and Rear View

- |                          |                         |
|--------------------------|-------------------------|
| 1. WiFi & RF Antennas    | 2. Mobile Holder        |
| 3. Indicator Light Panel | 4. Smart Control Switch |
| 5. Flight Mode Switch    | 6. Left Command Stick   |
| 7. Right Command Stick   | 8. Strap Hole           |
| 9. Power Button          | 10. Take-off Button     |
| 11. Landing Button       | 12. Micro USB Port      |

- |                   |                          |
|-------------------|--------------------------|
| 13. Support Stand | 14. Re-pair Hole         |
| 15. WiFi Switch   | 16. CE/FCC Control Screw |
| 17. Buzzer        | 18. Battery Compartment  |

**Table 2-13** Remote Controller Functional Descriptions

Name	Description
1. WiFi & RF Antennas	<ul style="list-style-type: none"> <li>• The 5.8GHz RF signal antenna communicates with and transmits control signals to the aircraft.</li> <li>• The 2.4GHz WiFi antenna receives and transfers flight data and camera data to the X-Star Mobile App.</li> </ul>
2. Mobile Holder	Holds the mobile device with the X-Star Mobile App installed with up to 90 ° adjustable viewing angle for optimum visibility.
3. Indicator Light Panel	Indicates different status of: <ul style="list-style-type: none"> <li>• GPS satellite signal strength</li> <li>• Aircraft battery level</li> <li>• RF remote control signal strength</li> <li>• WiFi communication</li> </ul> See <a href="#">2.3.2 Remote Controller Indicator Lights</a> on page 24 for detailed information.
4. Smart Control Switch	Switch to activate the Smart Flight function of IOC or Go Home controls.
5. Flight Mode Switch	Switch to change flight modes: Up: GPS Mode Middle & Down: ATTI Mode

Name	Description
6. Left Command Stick	Set by default: Throttle Up and Down: ascends and descends Rudder Left and Right: yaws left and yaws right
7. Right Command Stick	Set by default: Elevator Up and Down: forward and backward Aileron Left and Right: left and right
8. Strap Hole	Attaches to a neck strap for easy portability.
9. Power Button	Long press for 3 seconds to turn on/off the remote controller, a quick buzz can be heard at the same time. The power button shows solid green light when the remote controller is turned on. See <a href="#">2.3.2 Remote Controller Indicator Lights</a> on page 24 for detailed information.
10. Take-off Button	When the motors start up, pressing this button for 3 seconds commands the aircraft to take off and hover at an altitude of 2m. A buzz sound can be heard at the same time when activated.
11. Landing Button	Pressing this button for 3 seconds commands the aircraft to land. A buzz sound can be heard at the same time when activated.
12. Micro USB Port	Connects the remote controller to the PC through the Micro USB Cable supplied for battery charging, firmware update or RC configurations.
13. Support Stand	Holds up the remote controller at a 40 degree angle.

Name	Description
14. Re-pair Hole	Pressing the Re-pair Hole with a thin rod allows re-pairing the X-Star WiFi network.
15. WiFi Switch	Switches on/off the WiFi module to allow flight and video data transmission between the aircraft and the mobile device.
16. CE/FCC Control Screw	<ul style="list-style-type: none"> <li>• Turn the control screw for a full clockwise turn to set as CE compliant;</li> <li>• Turn the control screw for a full counter-clockwise turn to set as FCC compliant.</li> </ul>
17. Buzzer	Makes alert sounds.
18. Battery Compartment	Contains a rechargeable Li-Ion battery.

See [4.3 Remote Controller and Flight Operations](#) on page 43 for more instructions about the remote controller operations.

---

**NOTE:** The Remote Controller makes an alert sound after 15 minutes of inactivity, and turns off automatically after 30 minutes of inactivity.

---

### 2.3.2 Remote Controller Indicator Lights

There are 7 indicator lights on the remote controller, among which 4 are displayed on the Indicator Light Panel at the front top; the other 3 indicators are displayed separately on the Power Button, the Take-off Button and the Landing Button.

The Indicator Light Panel is activated when the WiFi switch at the back of the remote controller is turned on. It displays in response to the flight data received through the X-Star WiFi network, so make sure to pair up the devices first.





---



**NOTE:** The 4 indicator lights on the Indicator Light Panel display solid red lights when the X-Star WiFi network is disconnected.

---

The definitions for each of the Indicator Light are described in the table below:

**Table 2-14 Remote Controller Indicator Lights**

Item	Button	Description
GPS Signal		<ul style="list-style-type: none"> <li>Shows green light when GPS mode is enabled and more than 6 GPS satellite signals are received;</li> <li>Shows red light when the GPS mode is disabled or less than 6 GPS satellite signals are received.</li> </ul>
Aircraft Battery		<ul style="list-style-type: none"> <li>Shows green light when the aircraft battery is sufficient;</li> <li>Shows yellow light when the aircraft battery level is less than 20% (2<sup>nd</sup> Level Low Battery Protection activated);</li> <li>Shows red light when the aircraft battery level is less than 10% (1st Level Low Battery Protection activated).</li> </ul>
RF Signal		<ul style="list-style-type: none"> <li>Shows green light when communication between the remote controller and the aircraft through RF signals is active and stable;</li> <li>Shows red light when communication between the remote controller and the aircraft is lost.</li> </ul>
WiFi Signal		Shows green light when the X-Star WiFi network is active and stable;
RC Power		<ul style="list-style-type: none"> <li>Shows green light when powered up;</li> <li>Shows red-green flashing light when the remote controller battery voltage is low;</li> <li>Shows red flashing light when charging.</li> </ul>

Item	Button	Description
Take Off		Lights up when pressed, turns off when released.
Landing		Lights up when pressed, turns off when released.

### 2.3.3 Technical Specifications

Item	Descriptions
Operating Frequency (RF Receiver)	5.8GHz
WiFi Repeater Frequency	2.4GHz
Operating Temperature	0°C~50°C
Storage Temperature	-20°C~75°C
Communication Distance (open area)	CE:400m; FCC:800m;
Transmission Power (EIRP)	CE: 25mW; FCC:150mW;
Operating Current/Voltage	WIFI ON: Max. 550mA@3.7V
Battery	5000mAh rechargeable Li-Ion Battery
Power Consumption	Max:2.2W
Weight (battery included)	610g



---

## Chapter 3 Pre/Post-flight Operations

The X-Star features the user-friendly design that requires very simple assembly to get the aircraft ready to fly. However, it is essential to read and follow all the instructions and warnings in this manual, prior to assembly, setup or use, in order to operate correctly and avoid damages or injuries.

---

**IMPORTANT:** Do not use with incompatible components or alter this product in any way inconsistent with this manual, failure to operate this product in a safe and responsible manner could result in injury or damage.

---

### 3.1 Preparing Aircraft

Follow the instructions in this section to prepare the Aircraft for flight.

#### 3.1.1 Removing Gimbal Lock

Remove the Gimbal Lock before powering up the Aircraft to avoid damage. Pull out the attached gimbal lock carefully as illustrated below (*Figure 3-1*):

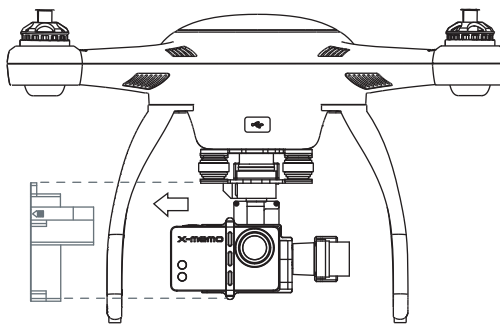

**Figure 3-1** Removing the Gimbal Lock

---

Replace the Gimbal Lock to protect the gimbal from accidental rotation to avoid damage when not in use.

### 3.1.2 Installing Propellers



---

**IMPORTANT:** Do not power up the aircraft while installing or removing the propellers. Use only authorized propellers.

---

It is recommended to wear protective gloves when assembling and removing the propellers.

On each of the propellers there are one Lock icon and one Unlock icon with an arrow icon indicating the rotate direction to fasten or unfasten the propellers.

Name	Icon	Description
Lock Icon		Fasten the propeller by rotating the propeller in the indicated direction.
Unlock Icon		Unfasten the propeller by rotating the propeller in the indicated direction.

➤ **To install the propellers**

1. Remove the warning cards from motors after reading. Do not power up the aircraft.
2. Match two of the propellers with red nuts to the corresponding motors with red paint, and the other two with black or gray nuts to the unpainted motors.
3. Fasten the propeller by rotating in the direction indicated by the Lock Icon.

➤ **To remove the propellers**

1. Power off the aircraft.
2. Unfasten the propeller by rotating in the direction indicated by the Unlock Icon.

---

**IMPORTANT:**

1. Check and ensure every propeller is properly installed and in good condition before each flight.
  2. Keep off and do not touch the propellers and motors when they are spinning.
- 

### 3.1.3 Charging Flight Battery

➤ **To charge the Aircraft Battery**

---

**NOTE:** If the current battery level is  $\geq 80\%$ , turn on the battery before charging.

---

1. Connect the supplied Aircraft Battery Charger to the wall socket.
2. Connect the battery to the charger. The Capacity Indicator Lights will illuminate and indicate the battery level during charging. (See [Table 3-1](#) on page 30 for details.)
3. The Capacity Indicator Lights will turn off when the battery is fully charged. Disconnect the charger and the battery when charging is completed.

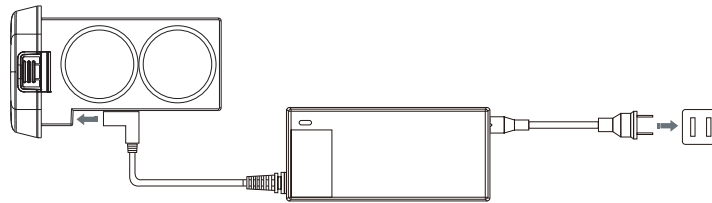

**Figure 3-2** Charging the Aircraft Battery

The table below describes the specific battery levels indicated by the Capacity Indicator Lights when charging.

**Table 3-1** Capacity Indicator Status while Charging

● - Indicates solid green light; ○- Indicates flashing green light

Indicator Status	Battery Level
● ● ● ●	≥95%
● ● ● ○	≥80%
● ● ○	≥50%
● ○	≥25%
○	≤25%

### 3.1.4 Installing and Removing the Battery

➤ **To install the battery**

1. Make sure the battery is powered off before installation.
2. Insert the battery into the aircraft battery compartment as shown below (*Figure 3-3*). A click sound is heard when the battery has been properly installed.

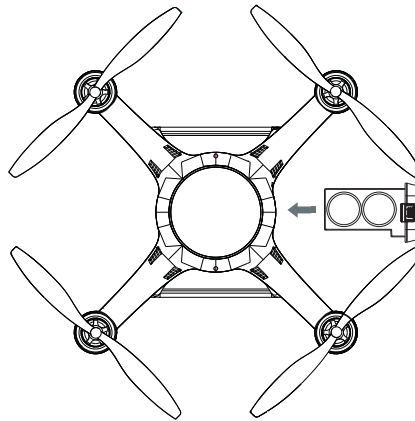

**Figure 3-3** Installing the Aircraft Battery

---

➤ **To remove the battery**

1. Make sure the battery is powered off before removal.
2. Press and hold the top and bottom tabs on the battery, and pull it out slowly.

### 3.1.5 Mounting the Camera

In the case when the purchased gimbal set does not come with a camera. The camera needs to be mounted manually by the user before flight.

---

**NOTE:** Use only cameras authorized or specified by Maxaero which are compatible with the gimbal.

---

➤ **To mount the camera**

1. Align and connect the Mini USB Port on the camera to the Camera Connector on the gimbal.
2. Align the upper and lower screw holes of the Camera Securing Bracket to the corresponding holes on the gimbal mount.
3. Fasten the securing bracket to the gimbal mount by screwing up the screws supplied, through the aligned holes (*Figure 3-4*).

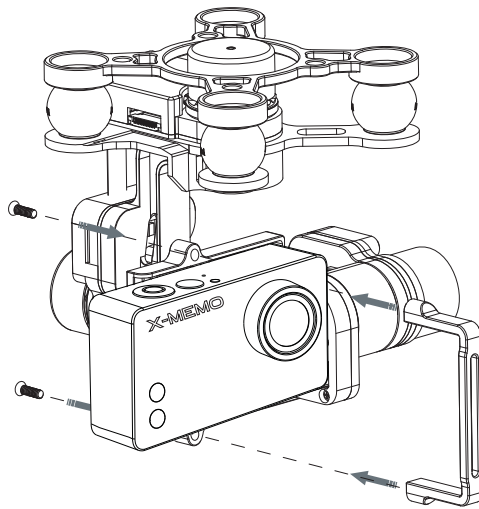

**Figure 3-4** *Mounting the Camera*

### **3.2 Preparing Remote Controller**

- **To charge the Remote Controller**
  1. Connect the remote controller to the USB Power Adapter using the Micro USB Cable supplied.
  2. Plug the USB Power Adapter to the wall socket.
  3. The Power Button on the remote controller will show flashing red light during charging. When charging is complete, the Power Button changes into solid green light, in this case, disconnect the power adapter and the remote controller.

---

➤ **To power up the remote controller**

---

**NOTE:** It is recommended to power up the remote controller before turning on the aircraft.

---

1. Adjust the remote controller power output by twisting the CE/FCC Control Screw using a Philips screwdriver. Turn the screw clockwise for a full turn to set as CE compliant; or turn the screw counter-clockwise for a full turn to set as FCC compliant.
2. Press and hold the Power Button for 3 seconds until the Power Button lights up in solid green. At the same time, 2 brief buzz sounds can be heard if the remote controller is set as CE compliant, whereas 3 brief buzz sounds can be heard when set as FCC compliant.
3. Turn on the WiFi switch at the rear side of the remote controller. The remote controller retrieves flight data while communicating with the aircraft and the indicator lights will light up indicating various aircraft and connection status.

### **3.2.1 Re-pairing Remote Controller**

The Remote Controller and the aircraft are paired by default, this enables the devices to pair up automatically when both powered up.

Re-pairing between the aircraft and the Remote Controller may be required when one of the devices has been replaced. In this case, perform re-pairing by using the RC Pairing Button on the aircraft (see [2.2.1 Functional Description](#) on page 7 for more information).

---

➤ **To re-pair the aircraft and the remote controller**

1. Turn off the remote controller.
2. Turn on the aircraft.
3. Press and hold the RC Pairing Button on the aircraft for about 3 seconds, the pairing indicator beside the RC Pairing Button will flash slowly in green light, indicating the aircraft is ready to re-pair.
4. Push and hold the left command stick leftward while pressing and holding the Power Button on the remote controller for a few seconds, the pairing indicator will change from slow flashing light to quick flashing light when pairing is successful.

### **3.3 Preparing Mobile Device**

By connecting your mobile device to the X-Star WiFi network, the X-Star Mobile App configures the device to perform as a FPV monitor and a ground station for remote piloting, flight configuration and waypoint navigation, etc.

The X-Star mobile application works on either iOS or Android smart phones. It can be downloaded from the official website, google play, apple store or by scanning the QR code shown on the package.

Supported system:

- A. iOS6.1 or later
- B. Android 4.0 or later



---

### 3.3.1 Installing Mobile App

Download the X-Star Mobile App from the website, and follow the procedures below to install it on your mobile device. Detailed information about X-Star Mobile app operations will be described in *4.4 X-Star Mobile App Operations* on page 53.

➤ **To install the X-Star Mobile App:**

1. Power up the mobile device, and launch the browser after the internet connection is enabled.
2. Login to the official website: <http://www.maxaero.com>.
3. Click **Download** on the home page.
4. Search and download the installation file of X-Star Mobile App
5. Tap **Install** and the X-Star application will be installed onto your mobile device.

---

**NOTE:** The X-Star application will be regularly updated. Please check occasionally for latest updates.

---

### 3.3.2 Registering User Account

When the X-Star Mobile app is properly installed, tap the app icon to run the software. The first thing to do is to log into your X-Star account before further operation. If you haven't created your account, tap **Register** and follow the instructions to complete your registration.

### 3.3.3 Establishing X-Star WiFi Network

The X-Star WiFi Network is established when the aircraft, the remote controller and the mobile device are properly connected through WiFi connection. This enables the mobile device to receive real time camera data in-flight and monitor flight maneuvers through the X-Star Mobile App.

---

➤ **To connect the mobile device with the X-Star network**

1. Power up the remote controller.
2. Power up the X-Star aircraft.
3. Switch on the Wi-Fi connection on your mobile device.
4. Tap the **Settings** option on your mobile device. Turn on the WiFi function, and select the X-Star Network from the list. The network may display as X\_Star suffixed with a serial number.
5. Open the X-Star Mobile App on your mobile device.
6. The SSID of the network and a green tick icon will be displayed on top of the main screen of the X-Star App when the connection is successful.

### 3.3.4 Re-pairing X-Star WiFi Network

When the X-Star WiFi Network connection fails, or either the aircraft or the remote controller is replaced and re-paired, the X-Star WiFi Network will need to be re-established as well.

➤ **Re-pair the X-Star WiFi Network**

1. Power on all the devices including the aircraft, the remote controller, and the mobile device.
2. Re-pair the aircraft and the remote controller if one of the devices is replaced. See [3.2.1 Re-pairing Remote Controller](#) on page 33 for detailed instructions.
3. After powering up the remote controller for 30 seconds, press and hold the Re-pair Hole at the back of the remote controller with a thin rod until a brief alert sound is heard.
4. Wait for 30 seconds until the WiFi Signal indicator on the remote controller starts flashing, indicating the WiFi network is ready to be re-established.

- 
5. Enable Wi-Fi connection on your mobile device.
  6. Select the X-Star Wi-Fi network from the list.
  7. Tap to launch the X-Star Mobile App, and tap the **Settings** icon.
  8. Choose **Pairing** in the menu list to enter the Pairing page (*Figure 3-5*).
  9. Tap **MAC** button to manually enter or scan the MAC code of the aircraft.

---

**NOTE:** By scanning the QR code at the bottom of the aircraft, the SSID and the MAC address will be automatically retrieved.

---

10. Tap **Finish** to complete the re-pairing. The WiFi Signal indicator on the remote controller will show solid green light when connection is successful.

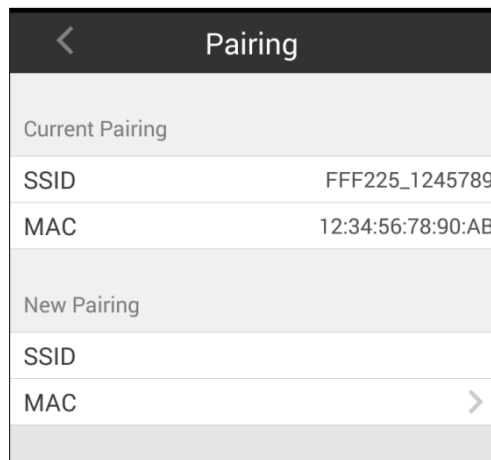

**Figure 3-5** Pairing Screen

---

## 3.4 Installing PC Aid Suite

The PC Aid Suite is specially developed for enhancing aircraft capabilities and refining flight performance. This comprehensive program allows users to perform pre and post flight configurations and upgrade firmware for the X-Star aircraft, gimbal and remote controller on the PC.

The PC Aid software package is included in the product CD supplied, and it is regularly updated through the internet.

➤ **To install the PC Aid software to the PC:**

1. Insert the CD into the CD-ROM of the PC. The driver installation wizard will load momentarily.
2. Click **Next** on the welcome page.
3. Click the **Change** button, and select a destination folder to install the program, and click **Next** to continue. Or directly click **Next** to continue without changing the default installation folder.
4. Click **Install** and the PC Aid Setup.exe program will be installed onto the PC.

### 3.4.1 Register PC Aid Account

After the PC Aid Suite is properly installed, click the **Windows Start Menu**, select **X-Star PC Aid** to launch the program. When using for the first time, users are required to create the X-Star user account before login. Click **Register** and follow the onscreen instructions to finish your registration. It is recommended to register with the same user account you used for the X-Star Mobile App.



**Figure 3-6** *Login Prompt*

After successful registration, enter your X-Star username and password to sign in the PC Aid operation program.

See [4.5 PC Aid Operations](#) on page 79 for detailed operation instructions of the PC Aid software.

---

## Chapter 4 Flight Operations

After all pre-flight preparations have been done properly, before proceeding to perform your first flight, take a few minute to familiarize yourself with the controls of your X-Star by following the operation instructions described in this section.

---

**IMPORTANT:** Before flying the X-Star aircraft, make sure all safety instructions presented throughout this manual be read and understood by all persons operating, or coming into contact with the product.

---

### 4.1 Preflight Checklist

Follow the steps below to carry out a full preflight check-up to get ready for the first flight.

- **Check up before flight**
  - ✓ The camera is stably mounted to the gimbal.
  - ✓ The camera lens cap is removed.
  - ✓ The gimbal lock is removed.
  - ✓ The propellers are properly installed and in good condition.
  - ✓ The flight battery, the remote control, the camera and the mobile device are fully charged.
  - ✓ The aircraft and the remote controller are paired.
  - ✓ The X-Star Mobile App and the PC Aid software are properly installed.
  - ✓ Firmware of the flight, gimbal, and remote control systems has been updated to the latest version.
  - ✓ The configurations of the flight, gimbal, and remote control systems are done properly.

- 
- ✓ The mobile device is mounted to the remote controller and properly connected to the X-Star WiFi Network.
  - ✓ The ground station on the X-Star Mobile App is enabled.
  - ✓ The camera function on the X-Star Mobile App is synchronizing with the mounted camera.
  - ✓ Familiarize yourself with the flight controls.
  - ✓ Find a suitable area for flying.

## 4.2 Calibrating Compass

Make sure to calibrate the compass every time when flying in a new location. The 4 LED indicators on the aircraft will show yellow flashing light when the flight system detects compass deviation, indicating that compass calibration is required.

---

**IMPORTANT:** The compass is very sensitive to electromagnetic interference, which may cause compass error leading to poor performance or flight failure.

---

Be sure the following requirements are met when carrying out compass calibration:

- ✓ Perform calibration outdoors (recommended to perform on an open space such as a lawn);
- ✓ Be free from all magnetic interferences, such as magnetite or steel reinforcement found in concrete;
- ✓ Be away from both underground and overhead power lines.

➤ **To calibrate the compass**

1. Quickly flip the Flight Mode Switch up and down for 5 times or above. The rear LEDs on the aircraft will show solid yellow lights when the calibration command is confirmed.

- 
2. Hold the aircraft horizontally and revolve for 360° around. The rear LEDs on the aircraft will change into solid green lights when this is done successfully.

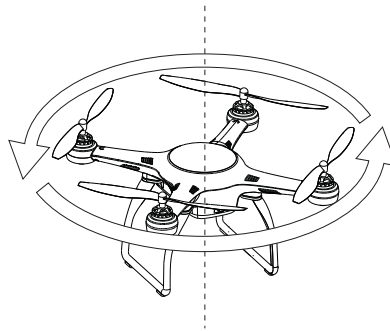

**Figure 4-1** *Horizontal Calibration*

3. Hold the aircraft vertically with the nose down and rotate for 360° around. The LEDs on the aircraft will display normally in correspondence to the current flight mode when calibration is completed successfully.

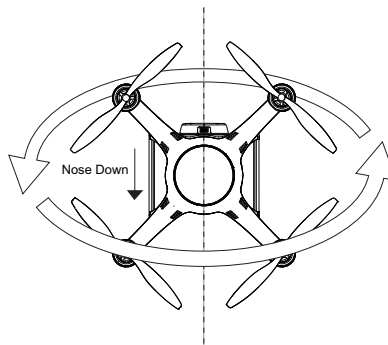

**Figure 4-2** *Vertical Calibration*

---

**NOTE:** If the calibration is unsuccessful, the LEDs on the aircraft will flash yellow lights again. In this case, repeat the above steps to try again.

---



---

## 4.3 Remote Controller and Flight Operations

The Remote Controller is specially designed for convenient remote flight controls with 2 command sticks for aerial maneuvers in different directions, including Pitch, Roll, Yaw and Vertical (ascent and descent).

The Smart Control Switch on the top left of the remote controller front panel allows pilots to conveniently activate the safety features – IOC (middle) or Go Home (down). Do not apply the IOC or Go Home controls when taking off.

The Flight Mode Switch on the top right of the remote controller front panel allows pilots to switch between different flight modes – GPS or ATTI mode. See [Table 2-5](#) on page 10 for details.

---

**NOTE:** Do not fly in GPS mode when less than 6 satellite signals are received. In this case, the aircraft will not be able to take off.

---

### 4.3.1 Motor Start-up and Take-off

The motors must be started before commanding the aircraft to take off. The standard operating procedures are described below.

➤ **To start the motors and take off**

1. Push the Smart Control Switch to the Up position as the IOC and Go Home features are not applied.
2. Push the Flight Mode Switch to the position of a desired mode for flight control.
  - A. Up: GPS Mode
  - B. Middle: ATTI Mode
  - C. Down: Manual Mode (disabled by default)
3. Push and hold both the Command Sticks to their bottom corners either toe-in or toe-out for a few seconds to start the motors.

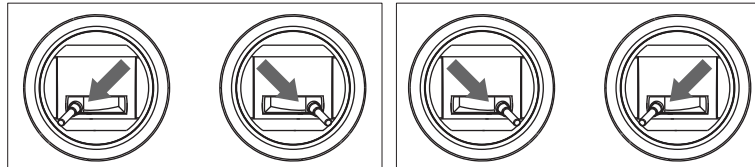

**Figure 4-3** *Motor Start-up or Shut-down*

4. Release the sticks gently and simultaneously after the motors have started spinning for 2 seconds.
5. Command the aircraft to take off. There are 2 methods available:
  - A. Push the Throttle upward to take off the aircraft manually.
  - B. Press and hold the Take-off button on the remote controller for 2 seconds. The remote controller makes a brief beep sound when the take-off command is sent successfully.

Once the command is sent, the aircraft ascends automatically and starts hovering when it reaches the height of 2 meters.

### 4.3.2 Flight Attitude Controls

The aircraft reacts to the control inputs of the command sticks transmitted through the RF signals. The flight speed varies according to the push strength applied when moving the sticks.

---

**NOTE:** For beginners it is recommended to move the command sticks lightly and slowly to keep the aircraft flying in a controllable speed. By applying the GPS mode, the aircraft self-positioning capability is enabled, which allows more stable and safer flight maneuvers.

---

The 4 primary flight controls include:

- A. **Throttle** – commands the aircraft to ascend by pushing the stick upward, and descend by pushing it downward.

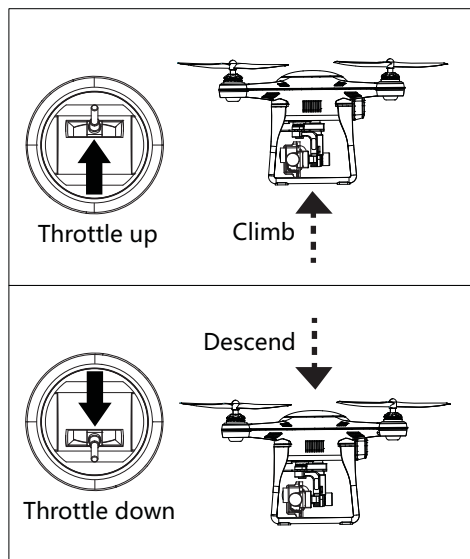

**Figure 4-4** *Throttle Control – Aircraft Left Side View*

- B. **Rudder** – commands the aircraft to yaw left or right by pushing the Rudder left or right.

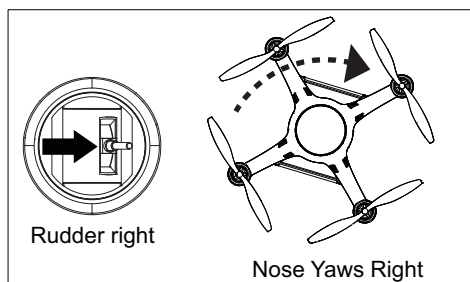

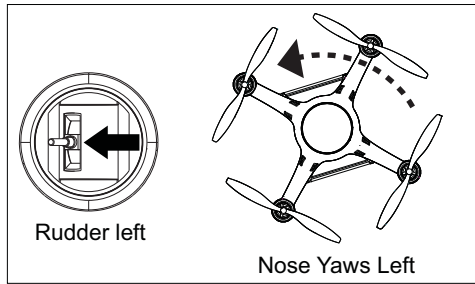

**Figure 4-5** Rudder Control- Aircraft Top View

- C. **Elevator** – commands the aircraft to pitch up and down to move forward or backward by pushing the Elevator upward or downward.

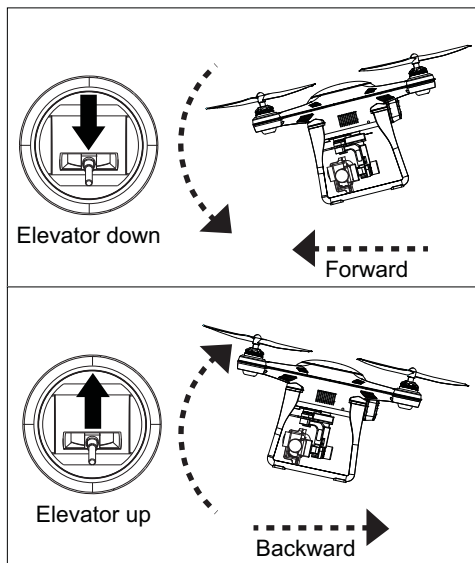

**Figure 4-6** Elevator Control – Aircraft Left Side View

D. **Aileron** – commands the aircraft to roll left or right by pushing the Aileron left or right.

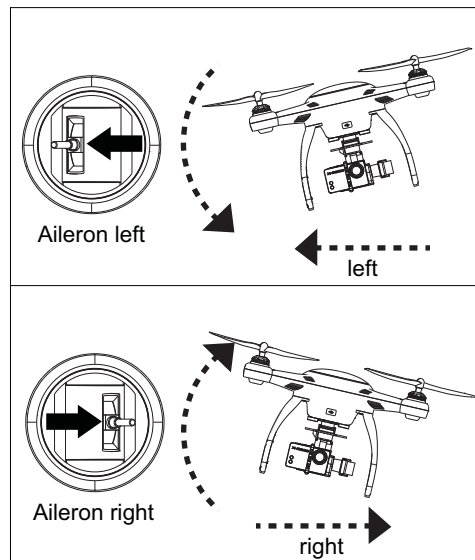

**Figure 4-7** Aileron Control – Front View

### 4.3.3 Landing and Motor Shut-down

The aircraft may be landed manually, automatically, or passively depending on different circumstances.

---

**IMPORTANT:** The aircraft must be landed gently on a flat surface to avoid damage.

---

- **Manual landing**

Pilots may manually land the aircraft whenever and wherever they choose and regard as safe by controlling the command sticks on the remote controller.

---

➤ **To manually land the aircraft and shut down the motors**

1. Maneuver the aircraft to the desired position for landing.
2. Release the command sticks when the aircraft reaches the target position to let it hover.
3. Push the Throttle down slightly and gently to land the aircraft.
4. When the aircraft has properly landed, operate with one of the command methods below to shut off the motors:
  - A. Push the Throttle to the bottom position and hold for 3 seconds, until the 4 motors stop spinning. This simple method is recommended for beginners.
  - B. Push and hold both the Command Sticks to their bottom corners simultaneously, either toe-in or toe-out, for a few seconds to stop the motors (*Figure 4-3*).
5. Release the stick(s) gently and simultaneously after the motors have stopped spinning.

● **Automatic landing**

The Landing Button on the remote controller allows pilots to land the aircraft automatically from where it is hovering (i.e. land onsite), with one single click, without worries of controlling the flight attitudes.

➤ **To auto land the aircraft using the Landing Button**

1. Maneuver the aircraft to the desired position for landing.
2. Release the command sticks when the aircraft reaches the target position to let it hover.
3. Press and hold the Landing Button for 3 seconds until a beep sound is heard.
4. Wait about 3 seconds and the aircraft will start to descend and land automatically.

---

- **Landing due to low battery**

Generally it is recommended to land the aircraft immediately when the battery level reaches 20% or lower, this will be indicated by the indicator lights on both the aircraft and the remote controller.

- A. The rear LEDs on the aircraft will show quick flashing red lights.
- B. The Aircraft Battery Indicator on the remote controller will show yellow light.

- **Passive landing due to low battery**

The aircraft will be forced to land automatically on wherever it is hovering when the battery level reaches 10% or lower to avoid accidents and damages.

- **Passive landing when Failsafe is activated**

When the Failsafe function is activated, the aircraft will perform Go Home (if GPS is available) or Onsite Landing (if GPS is not available) to avoid accidents and damages.

#### **4.3.4 Operations of Smart Flight Features**

The X-Star Smart Flight System supports 3 major smart features:

- **Intelligent Orientation Control**

To activate the IOC function during flight, toggle the Smart Control Switch on the top left of the remote controller to the middle position.

This feature has 2 control modes: Home Lock and Course Lock. The Home Lock mode works in GPS mode only, while the Course Lock mode works in both GPS and ATTI modes.

---

### Descriptions of the IOC modes:

**Home Lock** - configures the aircraft to fly in the direction relative to the home point, instead of its nose and tail. In this mode, the Elevator will always move the aircraft on a line towards or away from the initial take-off location, and the Aileron will make it move right or left perpendicular to that line.

**Course Lock** – also known as “Carefree Orientation” mode. In this mode, all control directions are based on the initial orientation of the aircraft, regardless of its current nose direction. This mode can be used to keep the aircraft staying on track even if it is being rotated.

In addition, Course Lock mode works regardless of distance from the starting point, while Home Lock mode requires the aircraft to be at least 10 meters away from home point. If the aircraft is getting closer within 10 meters boundary from home point, Home Lock mode will be automatically switched to Course Lock mode.

---

**NOTE:** The flying direction is relative to the starting point but not the location of the pilot. Home Lock mode works in GPS mode only while Course Lock mode works in both GPS and ATTI modes.

---

#### ● **Go Home**

The Go Home function only works in GPS mode. To manually activate the Go Home function using the remote controller, toggle the Smart Control Switch to the down position.

When the Go Home command has been successfully received, the aircraft automatically maneuvers itself to return and land on the prescribed home point with the shortest path.

When the Go Home procedure is activated, the remote controller control will be disabled temporarily while the aircraft returns to the home point. The Remote Controller control will be regained when the aircraft starts to descend allowing the pilots to adjust the aircraft attitude for a safe landing.



---

**NOTE:** For safety reasons, if the aircraft is hovering at the altitude lower than 30 meters when the Go Home function is activated, it will ascend to the 30-meter altitude before starting to return.

---

To manually regain control of the aircraft during the activated Go Home procedure, take one of the methods below:

**A. When Go Home is activated manually**

Toggle the Smart Control Switch from Go Home position to the other positions to regain control.

**B. When Go Home is activated by Failsafe**

There are 2 ways to regain control:

1. Press and hold the Take-off button on the remote controller for 3 seconds. A brief beep sound can be heard when the command has been sent successfully.

Move the command sticks to control the aircraft; if the aircraft reacts correspondingly, the communication is recovered.

2. Push the Throttle upward to the position of 60% in range, i.e. slightly above the middle point (*Figure 4-8*), and hold for 2 seconds. In this case, the aircraft may fly upward slightly when the remote controller control is recovered.

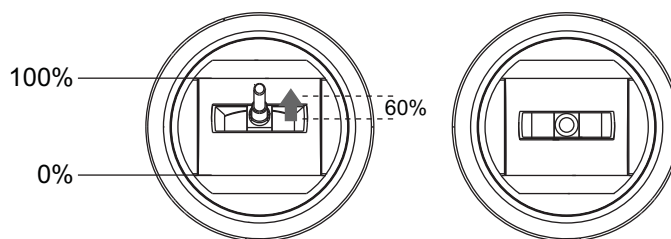

**Figure 4-8** Push the Throttle Upward (60% in range)

---

A home point is usually memorized by the system as the point where the aircraft motors start up each time. The home point can also be repositioned during flight.

➤ **Reposition the home point during flight**

1. Maneuver the aircraft to the desired home point.
2. Release the command sticks when the aircraft reaches the target position to let it hover.
3. Press and hold the Take-off Button for 3 seconds until a beep sound is heard.
4. Press the Take-off Button again within a 5-second interval; hold the button until a beep sound is heard.

The rear LEDs of the aircraft will show quick flashing green lights for 3 seconds indicating the reset is successful.

● **Failsafe**

The Failsafe function will be activated after 5 seconds when communication between the aircraft and the remote controller is lost. This function enables the aircraft to automatically take the protection measure.

Go Home is set as the priority protection measure when Failsafe is activated.

In the case when GPS is available at the time Failsafe is activated, the aircraft will start the Go Home procedure automatically.

In the case when GPS is not available (i.e. received GPS satellite signals are less than 6) when Failsafe is activated, the aircraft will hover for a 10 seconds interval. If GPS becomes available during this interval, the aircraft will start the Go Home procedure, otherwise the aircraft will land onsite.

---

## 4.4 X-Star Mobile App Operations

The X-Star Mobile Application is a fully-featured program with 4 essential functions. It configures your mobile to perform as the central monitor for remote piloting control, aerial shooting and recording, and helps to tune the aircraft parameters to achieve refined and smooth flight performance.

The 4 essential control functions are:

- A. Camera Remote Control** – performs capturing, recording and set camera settings through wireless control
- B. Flight Data Display** - displays parameters of:
  - Flight
  - Gimbal
  - Remote Controller
  - IMU Modules
  - Aircraft Battery
- C. Ground Station Navigation** – programs GPS waypoint navigation missions, and set waypoint altitude, hover time and overall speed
- D. Configuration Function** – performs parameter configuration for the flight control system, gimbal system and remote controller

### 4.4.1 X-Star Mobile App Main Menu



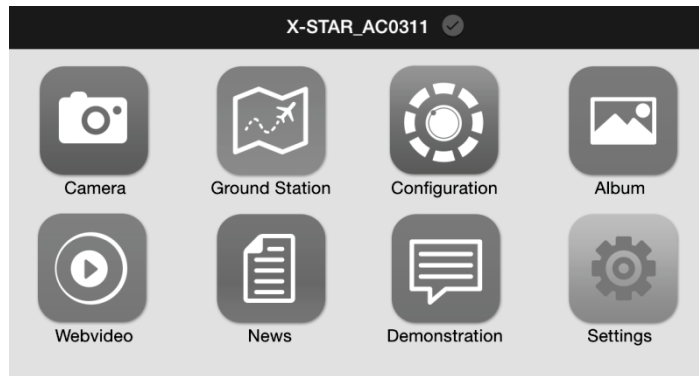

Before first flight, make sure your mobile device is properly connected to the X-Star WiFi network. When connection is successful, the SSID of the WiFi network alongside with a green tick icon will be displayed on the header of the Main Menu as below.



**Figure 4-9 X-Star Mobile App Main Menu**

The application buttons on the Main Menu are listed and described in the table below:

**Table 4-1 Application Buttons**

Name	Button	Description
Camera		Allows data synchronization for image display and camera pairing for FPV or non-FPV navigation
Ground Station		Allows to locate the aircraft, and perform waypoint navigation and flight settings
Configuration		Allows to perform parameter configuration and firmware upgrades for the flight, gimbal and remote control systems
Settings		Allows users to set various control settings of the application

## 4.4.2 Camera Operations

The Camera function works as a flight monitor that synchronizes the screen display with the onboard camera, allowing users to perform various camera operations and configurations for aerial photo-and-video shooting. To enter the Camera Operation screen (Figure 4-10), tap the **Camera** button on the Main Menu.



Figure 4-10 Camera Operation Screen

1. Pitch Control Panel
2. Status Information Bar
3. Camera Operation Panel
4. Ground Station Split Screen

- **Pitch Control Panel**

The Pitch Control Panel consists of 3 control buttons, the functions of which are described respectively from top to bottom as follows:

- 1) **Back** – returns to X-Star Mobile App Main Menu
- 2) **Mode Switch** – switches between Normal Mode and Physical Control Mode

---

### *Normal Mode*

In this mode, the camera pitch movement is controlled by the pitch scroll bar. Scroll it up to tilt the camera upwards or down to tilt the camera downwards.

### *Physical Control Mode*

In this mode, the camera pitch angle simulates with the motions of the mobile device. Tilt the mobile device forward to pitch the camera down or backward to pitch the camera up.

- 3) **Pitch Scroll Bar** – scrolls up or down to control the camera pitch movement (*Normal mode only*)

- **Status Information Bar**

The Status Information Bar on the top of the Camera Operation Screen consists of 8 items. The features of each item are described respectively from left to right as follows:

- 1) **Pitch Angle** – indicates the camera pitch angle
- 2) **Flight Altitude** – indicates planned flight height
- 3) **Flight Speed** – indicates the current flying speed
- 4) **Primary Flight Display** – indicates primary flight information including the flight attitude (pitch and roll), aircraft orientation, and approximate location
- 5) **WiFi Indicator** – indicates the intensity of WiFi signal
- 6) **Battery Level** – displays current aircraft battery level
- 7) **Micro-SD Card** – indicates the status of the Micro-SD Card  

The icon will be highlighted when a valid Micro-SD Card is properly inserted. The number beside the icon shows the remaining photo number.
- 8) **GPS** – displays the number of satellite signals received





- **Camera Operation Panel**

The Camera Operation Panel includes 5 items, the functions of which are described respectively from top to bottom as follows:

- 1) **Camera Settings** – opens the camera settings menu
- 2) **Camera Mode** – allows choosing different camera modes, including single capture, burst mode, timed capture and video shooting
- 3) **Shooting Button** – displays the current camera mode, tapping which allows to execute the selected camera mode action
- 4) **Hide/Display** – tap ► to hide the flight information bar and the pitch control panel; tap ◀ to show them again

The table below lists and describes the functions of the 4 camera modes.

**Table 4-2** *Camera Mode Buttons*

Mode	Button	Description
Single Capture		Captures a single photo
Video		Records video
Burst		Captures up to 10 photos in one second
Time Lapse		Captures a series of Photos at preset intervals

## Camera Settings



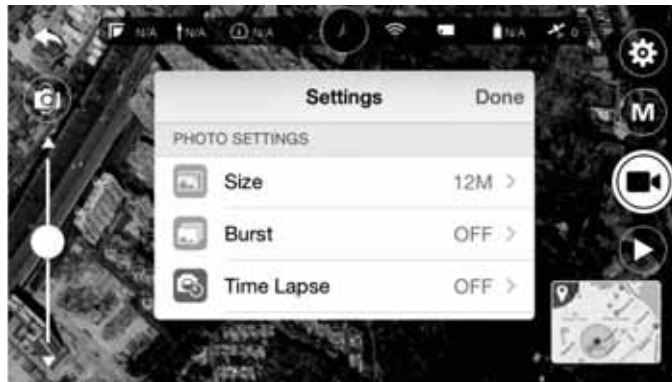

By tapping the **Settings** button, the Settings Panel will be displayed (*Figure 4-11*), which allows you to adjust camera configuration settings.





**Figure 4-11** Camera Settings Panel

The functions of each setting option are described in the table below:

**Table 4-3** General Camera Settings

Settings	Button	Options
Resolution		1080P (16:9) (default); 960P (4:3); 720P (16:9); WVGA (16:9)
Frame Rate		24, 30, 48, 60, 120, 240 fps (NTSC) *PAL: 50 fps.
Time Lapse		0.5, 1, 2 sec; 5 sec (default), 10, 30, 60 sec
Time Stamp		OFF (default); Date; Time; Date/Time



Settings	Button	Options
TV System		PAL; NTSC (default)
Format		√ ; × (default)
Reset		√ ; × (default)

**NOTE:** When you select Format in camera settings, the SD card will be formatted. Make sure to create a back-up copy of the SD card files.

When you select TV system to view a TV/HDTV, select NTSC for North American televisions; for those outside of North America, select PAL in most cases.

➤ **To format a Micro-SD card:**

1. Tap the **Camera Settings** button on the right side of the screen to open the Settings Panel.
2. Tap **Format** button and a prompt will appear to remind you that all data in the Micro-SD card will be deleted if you proceed with this action.
3. Tap **YES** to complete formatting.
4. Reboot the camera when completed.

**IMPORTANT:** Do not shut down the camera, or remove the battery or Micro-SD card during the procedure.

After the above settings have been completed, you can proceed with photo shooting or video recording.

➤ **To take a photo:**

1. Tap the **Camera Mode** button to select a desired shooting method.

---

**Single Capture:** press **Shooting** button once for a single photo

**Burst Mode:** press **Shooting** button once for continuous capture

**Time Lapse:** press **Shooting** button once to begin a timed capture, and press again to stop

2. Tap the **Shooting** button to run the selected camera mode action.

➤ **To record a video:**

1. Tap the **Camera Mode** button and select the **Video** mode.
2. Tap the **Shooting** button to start recording: a red dot will flash to indicate the recording is in progress and a time code will appear in the upper right corner of the preview screen.
3. Press the **Shooting** button again to stop recording.

➤ **To view the saved photos or videos:**

1. Press the **Back** button on Pitch Control Panel to return to the main menu.
2. Tap the **Album** icon to view the saved photos or recorded videos.

● **Ground Station Split Screen**

The Ground Station Split Screen, located on the lower right corner of the screen, allows the pilot to view the current Ground Station operation during camera filming. Tapping the Split Screen allows users to quickly switch to the Ground Station operation screen.

### 4.4.3 Ground Station Operations

The Ground Station function allows you to create flight plans by placing waypoints, setting waypoint altitude, hover time and overall speed, etc. To perform this function, tap the **Ground Station** icon on the Main Menu, and select a desired map type (Gmap or Amap) to initiate the program.

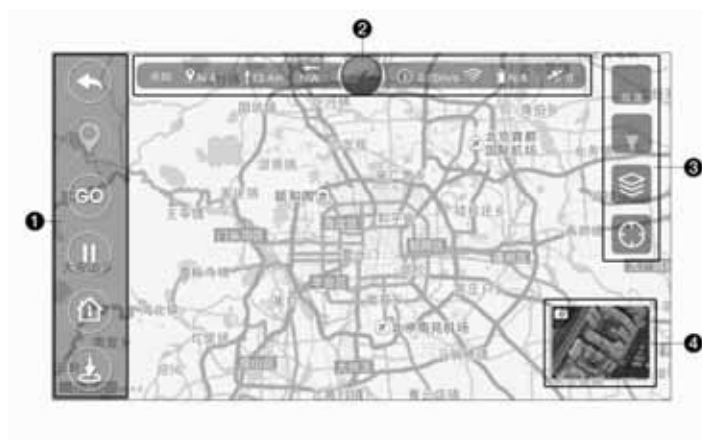

Figure 4-12 Ground Station Operation Screen







**NOTE:** Make sure your mobile device is connected to the internet when using this function for the first time to allow auto installing of the maps.

1. Control Panel
2. Status Information Bar
3. Functional Buttons
4. Camera Split Screen

- **Control Panel**

The Control Panel contains a number of buttons that allow you to create flight plans, execute flight missions and command the aircraft home. The table below provides a brief description of the Control Panel buttons:

**Table 4-4** Control Panel Buttons

Name	Button	Description
Back		Returns to X-Star Mobile App Main Menu
Waypoints		Opens the Waypoint Control Panel
Start		Uploads the flight mission
Pause		Suspends execution of the flight mission
Go Home		Aborts the flight mission and commands the aircraft home
Landing		Lands the aircraft

- **Status Information Bar**





The Status Information Bar on the top of the main sections of the screen displays the following items from left to right:

- 1) **Flight Mode** – indicates the current flight mode
- 2) **Flight Altitude** – indicates planned flight height
- 3) **Current Aircraft Distance** – indicates the distance between the current aircraft position and the home point
- 4) **Primary Flight Display** – indicates various flight information including the flight attitude (pitch and roll) characteristics, orientation, and approximate location info
- 5) **Flight Speed** – indicates the current flying speed
- 6) **Wi-Fi Signal** – indicates the intensity of Wi-Fi signal
- 7) **Battery Level** – displays current battery level
- 8) **GPS** – displays number of satellite signals received

- **Functional Buttons**

The Functional buttons are vertically aligned on the right side of the operation screen. They are mainly used for controlling flight speed, calibrating the compass, selecting map view and locating the home point. Detailed descriptions of the Functional Buttons are listed in the following table:

**Table 4-5** *Functional Buttons*

Name	Button	Description
Speed		Sets the desired level flight speed: high (8m/s), medium (5m/s) or low (2m/s).
Compass		Initiates the compass calibration procedure.
Map View		Allows choosing a desired map view: Normal, Hybrid or Satellite view.
Locator		Locates the current home point retrieved from X-Star system on the map; When aircraft GPS data is not available, it will locate the current mobile position on the map.

**NOTE:** For safety concerns, there are only 3 gears of level flight speed under auto mode: high speed (8m/s), medium speed (5m/s) and low speed (2m/s).

- **Main Section**

The Main Section, which occupies the center area of the screen, displays the map and the current location of the aircraft. In addition, there is a circle on the Main Section, within which defines the **Safety Zone**. The aircraft can fly in this area safely and legally.

➤ **To view the map on Main Section:**

1. Tap the **Map View** button to choose among the Normal, Hybrid or Satellite view.
2. Use two fingers to zoom in or zoom out the map.
3. Tap to move the map to view different areas.

● **Camera Split Screen**

The Camera Thumbnail, located on the lower right corner of the screen, allows the pilot to view the current camera filming during Ground Station operation. Tapping the thumbnail allows users to quickly switch to the camera operation screen.

● **Waypoint Operations**







Tapping the **Waypoints** button on the Control Panel opens launches the **Waypoint Operation Panel** (*Figure 4-13*).



**Figure 4-13** *Waypoint Operation Panel*

The Waypoint Operation Panel features the key functions of the Ground Station, which allows you to set flight plans by placing waypoints, defining flight altitude and hover time, etc. The table below provides brief functional descriptions of the Waypoint Operation Buttons:

**Table 4-6** *Waypoint Operation Buttons*

Name	Button	Description
<b>Back</b>		Exits the waypoint operation mode.
<b>Add Waypoints</b>		Adds a waypoint. The total number of waypoints should not exceed 20. Waypoints cannot be added beyond 500m from the home point or outside of the Safety Zone.
<b>Draw Waypoints</b>		Creates the flight route by sliding through the map.
<b>Remove Waypoints</b>		Removes the selected waypoint one by one.
<b>Move Waypoints</b>		Moves the waypoint position one at a time.
<b>Delete Waypoints</b>		Deletes all waypoints.
<b>Safety Zone</b>	N/A	Refers to the area within the circle. The aircraft can fly in this area safely and legally.

**NOTE:** To optimize video transmission quality, the aircraft is restricted to operate within a 500m-radius area from the Home Point.

➤ **To move the waypoints:**

1. Tap the **Move Waypoints** button.
2. Tap on the specific waypoint, and drag it to a new location.
3. Tap the **Move Waypoints** button again to confirm the change.

- 
- **To edit the waypoints:**
    1. Tap the desired waypoint number at the bottom of the screen.
    2. Adjust the waypoint altitude and hover time as demanded.
    3. Tap **OK** to complete the waypoint setting.
  - **To start the flight mission:**
    1. Tap the **Back** button to return to the Ground Station Control Panel after completing the waypoint flight plan setting.
    2. Tap **GO** on the Control Panel to start the flight mission.
  - **To terminate the waypoint mission:**

There are two ways to terminate the waypoint mission:

    - 1) Regain control of the aircraft by pushing the Flight Mode Switch on the remote controller to **ATTI** position. The aircraft will abort the mission and respond to the navigation by the remote controller.
    - 2) Tap the **Go Home** button to activate the Go Home procedure. The aircraft will terminate the mission and return to the home point and land automatically.
  - **To land the aircraft:**

When the flight mission has been completed, the aircraft will return to the home point (i.e. take-off point) automatically and hover.

There are 2 ways to land the aircraft:

    - 1) Regain control of the aircraft using the remote controller to land the aircraft manually or by using the 1-click **Landing** button
    - 2) Tap the **Landing** button on the Ground Station Control Panel.



#### 4.4.4 Configuration Operations

The Configuration program is designed to configure and upgrade the Smart Flight System and the Remote Controller. To optimize the X-Star system performance for accurate and stable flight maneuvering, it is recommended to perform configurations and firmware upgrades on a regular basis, either through PC Aid or X-Star Mobile App.

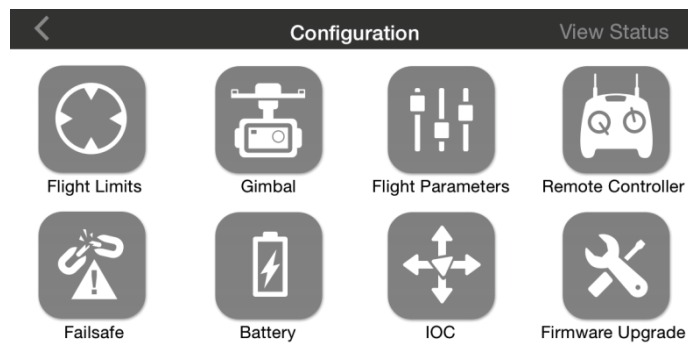

**Figure 4-14** Configuration Operation Screen

- **Flight Limits**

All unmanned aerial vehicle (UAV) pilots should comply with all regulations from ICAO (International Civil Aviation Organization) and national rules of the air in their own state.

For safety concerns, it is required to set up the flight limits to ensure safe and legal operation of this product. The flight limits settings include flight height, distance limits and Flight Restricted Areas.

To set the flight limits, click the **Flight Limits** icon and the screen below will be displayed:

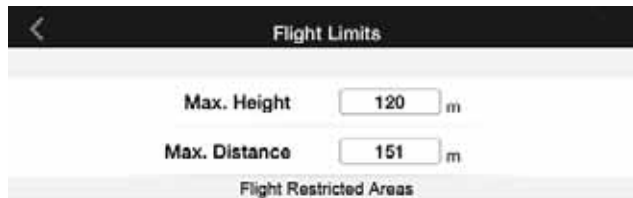

**Figure 4-15** *Flight Limits Setting Screen*

You can set the maximum flight height and distance to protect the aircraft from losing signal or being out of control. When these limits are determined, the aircraft cannot fly outside the preset limit boundaries under GPS mode. In non-GPS mode, the aircraft is only restricted to the preset height limit. For distance limit under non-GPS mode, it may be various depending on the regulations and laws in different areas and countries.

---

**NOTE:** Under GPS mode, the maximum flight height must be within 800 meters and flight distance must be within 1000 meters.

---

- **Gimbal**

The Gimbal function is designed to perform Gimbal parameters tuning such as sensitivity (roll, pitch and yaw) and control speed, and to activate or deactivate FPV mode. Tap the Gimbal icon, and the screen is displayed as below:

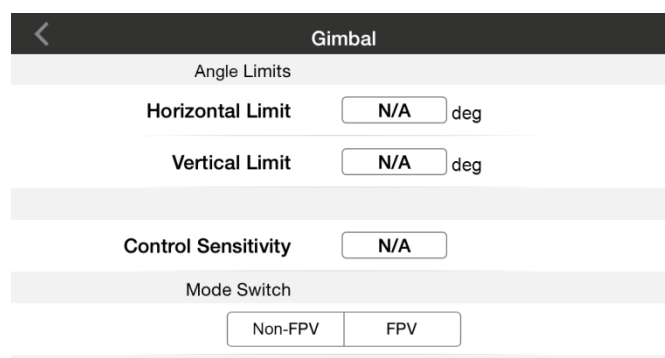

**Figure 4-16** *Gimbal Control Screen*

- 1) **Angle Limits**
  - A. Horizontal Limit – sets the maximum angle on horizontal axis
  - B. Vertical Limit – sets the maximum angle on vertical axis
- 2) **Control Sensitivity** - adjusts the speed of camera pitch movement
- 3) **Mode Switch**
  - A. Non-FPV Mode –enables stabilized camera tilting control
  - B. FPV Mode –synchronizes the camera gimbal movement with the aircraft

- **Flight Parameters**

The Flight Parameters option is used to tune the systemic parameters of the aircraft, including level flight speed, descent speed, ascent speed and yaw rate, so as to achieve safe and smooth flight maneuvers. Due to the highly stabilized control system, the level speed, descent speed, ascent speed and yaw rate can be adjusted within the following ranges:

Speed	Range
Level Flight Speed	2m/s – 12m/s
Descent Speed	1m/s – 3m/s
Ascent Speed	1m/s – 6m/s
Yaw Rate	60 °/s - 360 °/s

- **Remote Controller**

The Remote Controller function enables the pilots to choose preferred transmitter modes, calibrate command sticks and testify if the Smart Control Switch and the Flight Mode Switch work properly.

Tap the **Remote Controller** icon, and the screen below will be displayed.

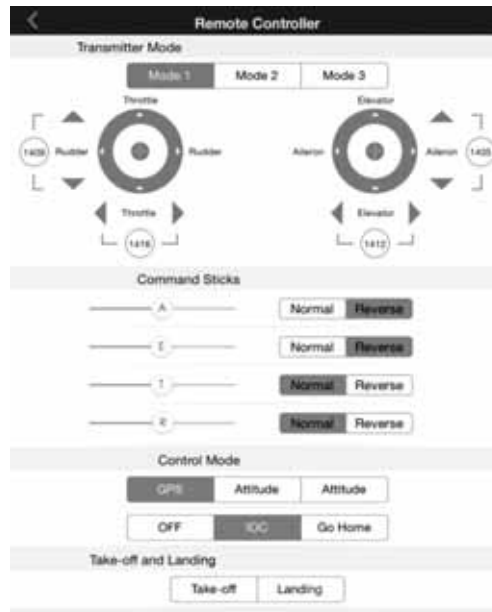
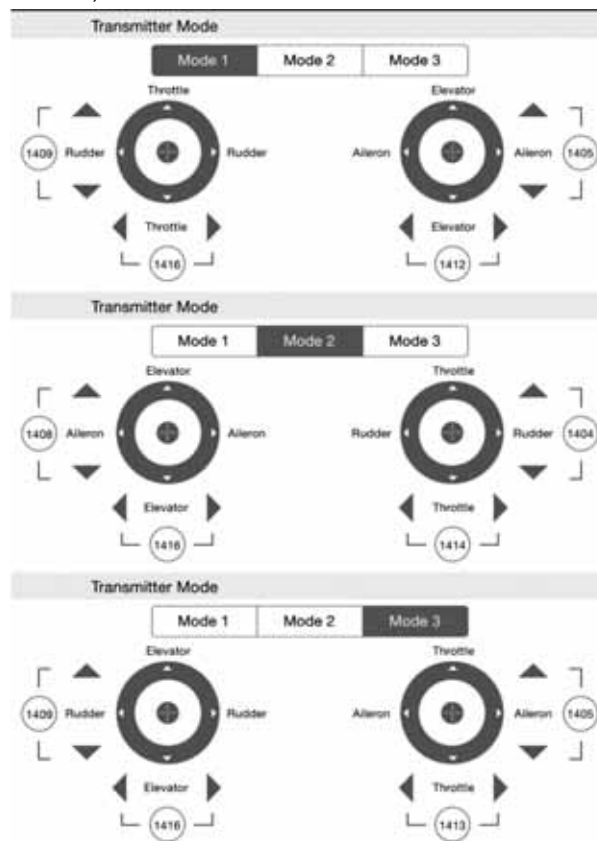

**Figure 4-17 Remote Controller Screen**

The Remote Controller configuration screen consists of 3 sections.

1) Transmitter Modes Section

There are 3 transmitter modes: Mode 1, Mode 2, and Mode 3. Each mode indicates how the movement of command sticks controls the actions of the aircraft correspondingly. Below are the illustrations of Mode 1, Mode 2, and Mode 3:



**Figure 4-18** Mode 1, 2 and 3

---

The table below describes the respective aircraft movements reacting to the movements of the command sticks.

**Table 4-7** *Controls of the Command Sticks*

Command Stick Movement	Aircraft Movement
Throttle Up/Down	Ascend/Descend
Rudder Left/Right	Yaw Left/Right
Elevator Up/Down	Forward/Backward
Aileron Left/Right	Left/Right

2) Command Sticks Calibration

There are 4 channels in total for command sticks calibration. They are A, E, T and R channels, representing Aileron, Elevator, Throttle and Rudder respectively. Before calibration, make sure your desired transmitter mode has been selected.

➤ **To calibrate the command sticks:**

1. Turn on the remote controller and then the aircraft.
2. Connect your mobile device to the X-Star Wi-Fi Network.
3. Launch the X-Star App on your mobile device.
4. Tap the **Configuration** icon on the main menu.
5. Tap the **Remote Controller** option.
6. Select your preferred transmitter mode and familiarize yourself with the controls of the sticks.
7. Rotate the sticks in a circular pattern by their maximum ranges several times and then back to the middle position. You can do both sticks at a time or one at a time.

- 
8. Tap **Finish** on the top right side to complete the calibration. If all scale icons (A, E, T and R) fall in the middle position, the remote controller is ready for use.

### 3) Switch and Button Test

The Switch and button Test section allows users to test the 2 switches on the front top of the remote controller and 2 buttons at the bottom of the remote controller.

The upper switch group allows testing of the Smart Control Switch which includes Normal, IOC and Go Home modes.

The lower switch group allows testing of the Flight Mode Switch which includes GPS, ATTI and ATTI modes.

The bottom two buttons allows testing of the 1-click Take-off and Landing buttons.

When pushing the switch on the remote controller to a specific position or press the specific button, the corresponding mode will be highlighted accordingly. Test both switches and buttons in each of their positions successively.



**Figure 4-19** *Switch and Button Test – in Normal Pos.*

- **Failsafe**

The Failsafe mode is set to enable the aircraft to take default emergency protection procedure when communication with the remote controller is lost, to prevent damage or injury. Go Home is set as the priority protection measure when Failsafe is activated.

When the Go Home procedure initiates, the aircraft's nose will be oriented towards Home Point. If the aircraft's altitude is lower than 30 meters, it will ascend to 30 meters height to reduce risks of crashing or damages. If the aircraft altitude is higher than 30 meters, then the aircraft will remain at its height level, and returns to the home point with the shortest flight route.

To view the demonstrations of the Failsafe procedure, tap the Failsafe icon and the screen as shown below will be displayed.

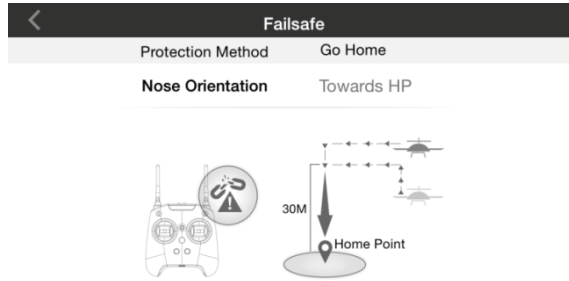

**Figure 4-20** *Failsafe Screen*

There are several occasions that may cause the loss of the remote controller signal:

- A. The controller has been turned off
- B. The aircraft has flown out of the distance limit
- C. The signal between the aircraft and the remote controller has been blocked or interfered



- **Battery**

The Battery function allows you to view the current status and general information of the aircraft battery, and check the Low Battery Protection settings. There are 2 levels of protection measures for the inflight low battery concerns. Tap the **Battery** icon to enter the battery screen as below:

Battery			
Current Status			
Voltage	N/A		
Current	N/A		
Battery Information			
Design Capacity	N/A	Temperature	N/A
Full Capacity	N/A	Serial Number	N/A
Current Capacity	N/A	Cell 1 Voltage	N/A
Battery Level	N/A	Cell 2 Voltage	N/A
Battery Life	N/A	Cell 3 Voltage	N/A
Discharge Times	N/A		
Second Level Protection		LED Quick Flash	
Battery Level	20%		
Go Home	<input type="checkbox"/>		
First Level Protection		Land Onsite	
Battery Level	10%		

**Figure 4-21** Battery Screen

The displayed battery information includes the following items:

- 1) **Current Status** – displays voltage and current values of the aircraft battery
- 2) **General Information** – displays general aircraft battery information
- 3) **Second Level Protection** – activated when the battery level reaches 20%, which by default triggers the rear LEDs on the aircraft to quick flash in red lights. Users can also activate/deactivate Go Home measure for this protection setting

- 
- 4) **First Level Protection** – activated when the battery level drops below 10% that forces the aircraft to immediately land onsite

It is highly recommended to activate the Go Home procedure or manually command the aircraft to return when the low battery alarm is triggered (i.e. when the rear LEDs of the aircraft show with quick flashing red lights).

- **IOC (Intelligent Orientation Control)**

Intelligent Orientation Control (IOC) is a smart feature that helps the pilot to navigate the aircraft without worrying about its nose direction. This is very helpful for new pilots to regain control of the aircraft orientation in case that the aircraft flies too far away from the home point or when its orientation is uncertain.

The IOC feature includes 2 modes:

- 1) Home Lock (HL) Mode
- 2) Course Lock (CL) Mode

See detailed descriptions of the IOC modes at [4.3.4 Operations of Smart Flight Features](#) on page 49.

Tap the **IOC** icon on the main menu, and the IOC screen is displayed ([Figure 4-22](#)).

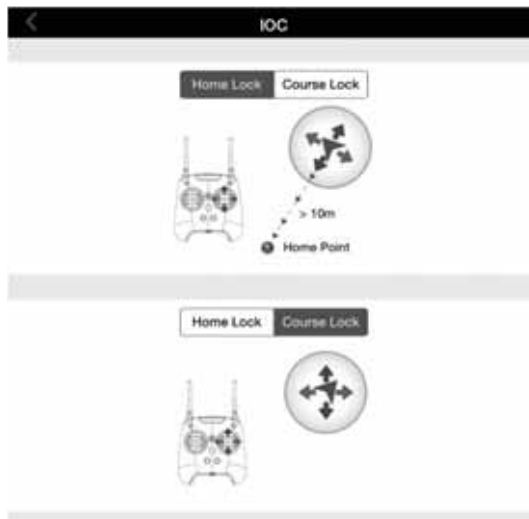

**Figure 4-22** IOC Screen

---

**NOTE:** The flying direction is relative to the starting point but not the location of the pilot. Home Lock mode works in GPS mode only while Course Lock mode works in both GPS and ATTI modes.

---

- **View Status**

Tapping **View Status** from the main menu displays an information screen, which presents an overview list of the configuration status of the X-Star system.

#### 4.4.5 Settings Operations

The **Settings** icon on X-Star Mobile App Main Menu allows the pilot to adjust 3 categories of items displayed on the Settings menu, including camera settings, flight control and gimbal settings and general settings.

- 
- **Camera Settings**
    - 1) **Toolbar Auto Hide** – slide the button to enable or disable auto hide of the operation panels
    - 2) **When Communication Lost** – allows to set the camera operation mode in case when communication is lost
    - 3) **Preview Quality** – tap to select the resolution and frame rate
  - **Flight Control and Gimbal Settings**
    - 1) **Parameter Unit** – tap to select a measurement unit: English or Metric
    - 2) **Ground Station** – slide the button to enable or disable the ground station feature
    - 3) **Compass Calibration** – tap to start compass calibration
    - 4) **Low Battery Auto Return** – slide the button to enable or disable the auto return function for low battery protection
    - 5) **FPV Mode** – slide the button to activate or deactivate the FPV mode
  - **General Settings**
    - 1) **Low Battery Protection** – slide the button to enable or disable the Low Battery Protection function
    - 2) **Tips** – tap to enable tip display during operation
    - 3) **Pairing** – displays the SSID and MAC information of the paired aircraft, and allows pairing to other aircraft by entering new SSID and MAC address
    - 4) **Rename SSID** – tap to rename the SSID of the X-Star WiFi Network
    - 5) **Find My X-Star** – locates the aircraft position according to the last GPS signal retrieved before communication is lost

## 4.5 PC Aid Operations

The PC Aid Suite is specially developed for enhancing aircraft capabilities and refining flight performance. This comprehensive program allows users to perform pre and post flight configurations and upgrade firmware for the X-Star aircraft, gimbal and remote controller on the PC.

Launch the PC Aid program after installation is complete.

After logging in to your PC Aid account, a prompt screen will appear to remind you to connect the aircraft or the remote controller to the computer, if you haven't done already. In this case, use the USB cable supplied to connect the devices. The PC Aid operation screen will be displayed when the connection is successful.



**Figure 4-23** PC Aid Operation Screen

---

The PC Aid Operation screen includes 3 main sections:

- **Menu Bar**

The Menu Bar consists of 4 tags:

- 1) Flight Control System Settings
- 2) Gimbal Settings
- 3) Remote Controller Settings
- 4) Firmware Upgrades

Selecting each tag will navigate you to the corresponding operation page.



- **Navigation Pane**



The Navigation Pane displays all the items that are required to be adjusted or calibrated for the flight system, gimbal and remote controller before or after flight. The items may vary according to the specific tag selected on the Menu Bar.

- **Main Screen**

This section, which occupies a great part of the display area on the PC Aid operating screen, shows various content depending on the operation selected on the Menu Bar and Navigation Pane.

**Table 4-8** *Functional Buttons under the Flight Tag*

Name	Button	Description
Flight Limits		Allows pilots to set limits for the flight height, distance and speed, and displays the different categories of flight restricted areas.
IMU Calibration		Examines and calibrates the parameters of the gyroscope, acceleration sensor, and compass to ensure accurate flight controls.

Name	Button	Description
<b>Failsafe</b>		Enables the aircraft to take automatic failsafe measure when communication with the remote controller is lost.
<b>Battery</b>		Displays the battery information, and allows activating/deactivating the low battery protection function.
<b>IOC</b>		Allows pilots to set the IOC mode for easy aircraft navigation when its orientation is uncertain.
<b>View Status</b>	N/A	Displays current configuration status of the X-Star system.

**Table 4-9** *Functional Buttons under the Gimbal Tag*

Name	Button	Description
<b>Basic</b>		Adjusts and calibrates gimbal parameters.

**Table 4-10** *Functional Buttons under Remote Controller Tag*

Name	Button	Description
<b>Remote Controller</b>		Allows pilots to choose preferred Remote Control Mode, calibrate command sticks, and testify if the control switches and sticks work properly.

---

## **Chapter 5 Maintenance and Service**

To ensure optimum performance of the product, we advise that the maintenance instructions in this section are read and followed carefully.

### **5.1 Maintenance Instructions**

The following shows how to maintain your devices, together with precautions to take.

- Keep the devices in dry conditions and within normal operating temperatures.
- Dry your hands before using the devices. The touch screen of the camera may not work if it is moist, or if you tap it with wet hands.
- Do not store the devices in humid, dusty or dirty areas.
- Do not attempt to disassemble your devices.
- Use a soft cloth with alcohol or a mild window cleaner to clean the touch screen of the camera.
- Do not use any abrasive cleansers, detergent or chemicals on the camera.
- Avoid dropping your devices, especially on a hard surface.
- Use only authorized battery chargers and accessories. Any malfunction or damage caused by the use of unauthorized battery charger and accessories will void the limited warranty.
- Ensure that the battery charger does not come in contact with conductive objects.



---

## 5.2 Troubleshooting Checklist

This section helps users to detect possible causes to certain problems occurred, and provide feasible solutions to handle certain operation failures.

- A. **When the aircraft indicates failure during self-check** (*with 4 LED lights flashing slowly in red and the buzzers beep all the time*)
  - ✓ Check if the IMU is properly calibrated through the PC Aid or X-Star Mobile App
  - ✓ Check if the remote controller parameters are properly calibrated
- B. **When the aircraft motors fail to start up**
  - ✓ Check if the remote controller and the aircraft are properly paired
  - ✓ Check if the remote controller parameters are properly calibrated
- C. **When take-off fails after motors are initiated**
  - ✓ Check if the Smart Control Switch is in the Normal position (flipped up)
  - ✓ Make sure the Flight Mode Switch is not in the GPS position when the GPS satellite signals are less than 6
  - ✓ Check if the battery level is high enough
  - ✓ Check if the aircraft is in no-fly zone
  - ✓ Check if the aircraft is placed on a flat ground
- D. **When the aircraft's flight time reduces**
  - ✓ Make sure the battery is in a warm environment before use

- 
- E. **When pairing up, the aircraft does not respond to the remote controller**
    - ✓ Make sure there is no large metal object, wireless source or other remote controller around
  - F. **If the Wi-Fi connection fails all the time**
    - ✓ Make sure to be free from all magnetic or signal interferences
  - G. **If the camera is powered off during video recording**
    - ✓ Keep the MicroSD card inside the camera. Restart the camera and wait until the video files are recovered (partial data may be lost)
  - H. **If acquisition of the SSID fails**
    - ✓ Check if both the aircraft and the remote controller are powered on
    - ✓ Make sure WiFi is enabled on both the mobile device and the Remote Controller
  - I. **If the aircraft is out of sight and the Wi-Fi connection is lost**
    - ✓ Enable Go Home procedure to let it return or activate IOC procedure to manually navigate it to return
  - J. **If the camera fails to be synchronized with the mobile device**
    - ✓ Check if your mobile device supports synchronization of the 1080i60 video files
    - ✓ If the video size is too large, it cannot be synchronized to the mobile device
    - ✓ Check if your mobile device is connected to X-Star WiFi Network
  - K. **If sharing of files failed**
    - ✓ Check if your mobile device is connected to the internet

- 
- L. **If the X-Star mobile app is accidentally closed when the aircraft is in Ground Station mode**
- ✓ If the app is closed when the flight mission is under execution, the aircraft will continue to finish
  - ✓ If the app is closed when the flight mission is being suspended, and failed to reconnect with the aircraft within 1 minute, Go Home procedure will be automatically activated
  - ✓ Regain manual control of the aircraft using the remote controller

## 5.3 Service Procedures

This section introduces information for technical support, repair service, and application for replacement or optional parts.

### Technical Support

If you have any question or problem on product operations, please:

- Call 0086-755-86147779 (China).
- Contact local distributors or agents.
- Visit our website <http://www.maxaero.com>.

### Repair Service

If it becomes necessary to return your device for repair, please download the repair service form from [www.maxaero.com](http://www.maxaero.com), and fill in the form. The following information must be included:

- A. Contact name
- B. Return address
- C. Telephone number
- D. Product name

- 
- E. Complete description of the problem
  - F. Proof-of-purchase for warranty repairs
  - G. Preferred method of payment for non-warranty repairs

---

**NOTE:** For non-warranty repairs, payment can be made via Visa, Master Card, or with approved credit.

---

**Send the device to your local agent, or to the following address:**

6th-10th Floor, Building B1, Zhiyuan, Xueyuan Road, Xili, Nanshan, Shenzhen, 518055, China

**Other Services**

You can purchase the optional accessories directly from Maxaero's authorized tool suppliers, and/or your local distributors or agents.

Your purchase order should include the following information:

- Contact information
- Product or part name
- Item description
- Purchase quantity

---

## Chapter 6 Warranty

Autel Aerial Technology Co., Ltd. (the Company) warrants to the original retail purchaser of this product, that should this product or any part thereof during normal consumer usage and conditions be proven defective in material or workmanship that results in product failure within the valid warrant period from the date of delivery, such defect(s) will be repaired, or replaced (with new or rebuilt parts) with Proof of Purchase, at the Company's option, without charge for parts or labor directly related to the defect(s).

Please visit <http://www.maxaero.com> for details of the limited periods warranted for the different parts of this product.

The Company shall not be liable for any incidental or consequential damages arising from the use, misuse, or mounting of the device. Failure to follow the safety instructions presented throughout the manual will void the warranty of the product. Some states or countries do not allow limitations on how long an implied warranty lasts, so the above limitation may not apply to you.

### **This warranty does not apply to:**

- a) Products subjected to abnormal use or conditions, accident, mishandling, neglect, unauthorized alteration, misuse, improper installation or repair or improper storage;
- b) Products whose mechanical serial number or electronic serial number has been removed, altered or defaced;
- c) Damage from exposure to excessive temperatures or extreme environmental conditions;
- d) Damage resulting from connection to, or use of any accessory or other product not approved or authorized by the Company;
- e) Defects in appearance, cosmetic, decorative or structural items such as framing and non-operative parts.
- f) Products damaged from external causes such as fire, dirt, sand, battery leakage, blown fuse, theft or improper usage of any electrical source.

**FCC Caution:**

This equipment has been tested and found to comply with the limits for a Class B digital device, pursuant to part 15 of the FCC Rules. These limits are designed to provide reasonable protection against harmful interference in a residential installation. This equipment generates, uses and can radiate radio frequency energy and, if not installed and used in accordance with the instructions, may cause harmful interference to radio communications. However, there is no guarantee that interference will not occur in a particular installation. If this equipment does cause harmful interference to radio or television reception, which can be determined by turning the equipment off and on, the user is encouraged to try to correct the interference by one or more of the following measures:

—Reorient or relocate the receiving antenna.

—Increase the separation between the equipment and receiver.

—Connect the equipment into an outlet on a circuit different from that to which the receiver is connected.

—Consult the dealer or an experienced radio/TV technician for help.

**FCC Caution:**

Any Changes or modifications not expressly approved by the party responsible for compliance could void the user's authority to operate the equipment.

This device complies with part 15 of the FCC Rules. Operation is subject to the following two conditions:

(1) This device may not cause harmful interference, and (2) this device must accept any interference received, including interference that may cause undesired operation.

This equipment complies with FCC radiation exposure limits set forth for an uncontrolled environment.

This equipment should be installed and operated with minimum distance 20cm between the radiator& your body.

This transmitter must not be co-located or operating in conjunction with any other antenna or transmitter.

Note:This equipment has been tested and found to comply with the limits for a Class B digital device, pursuant to part 15 of the FCC Rules. These limits are designed to provide reasonable protection against harmful interference in a residential installation. This equipment generates, uses and can radiate radio frequency energy and, if not installed and used in accordance with the instructions, may cause harmful interference to radio communications. However, there is no guarantee that interference will not occur in a particular installation. If this equipment does cause harmful interference to radio or television reception, which can be determined by turning the equipment off and on, the user is encouraged to try to correct the interference by one or more of the following measures:

—Reorient or relocate the receiving antenna.

—Increase the separation between the equipment and receiver.

—Connect the equipment into an outlet on a circuit different from that to which the receiver is connected.

—Consult the dealer or an experienced radio/TV technician for help.