

User Manual

Digital to Analog Audio Converter

OTHR-DAC02

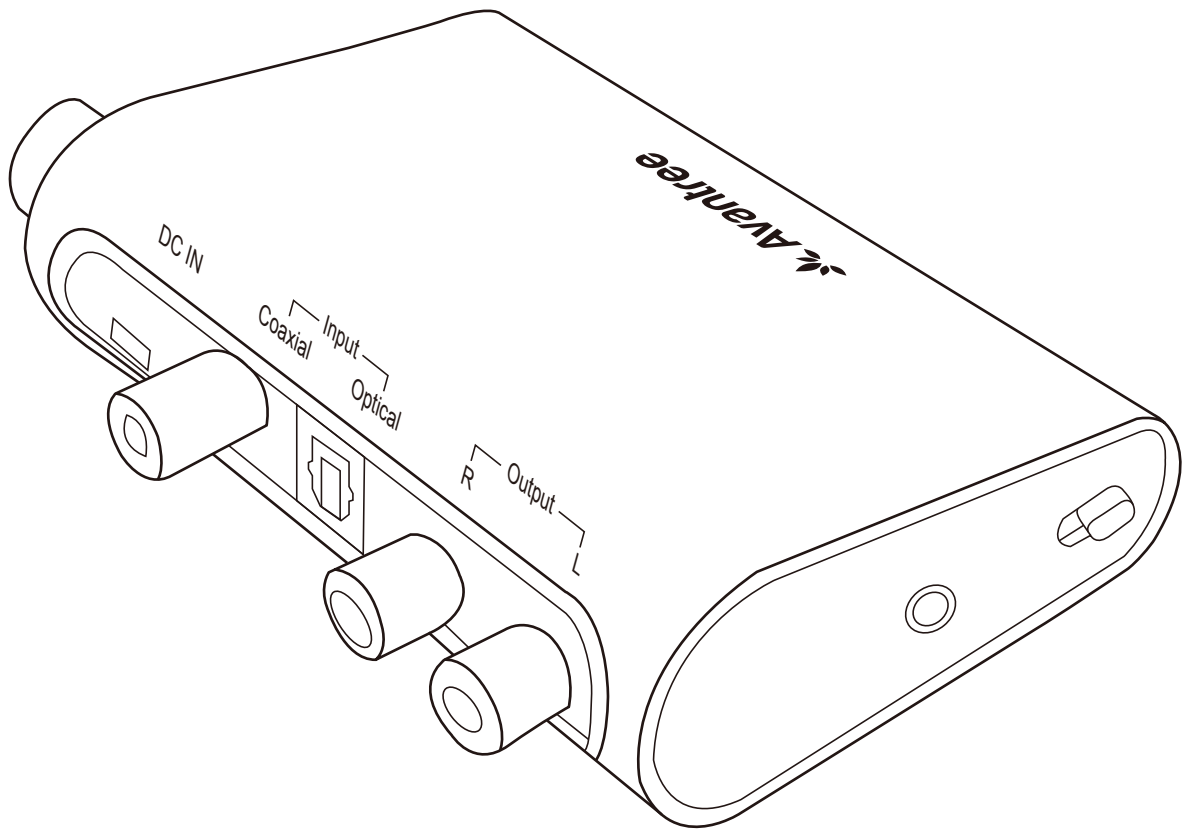

Product Overview	1
Power On	1
Cable Connection	2
TV Setting.....	4
Troubleshooting.....	4

Product Overview

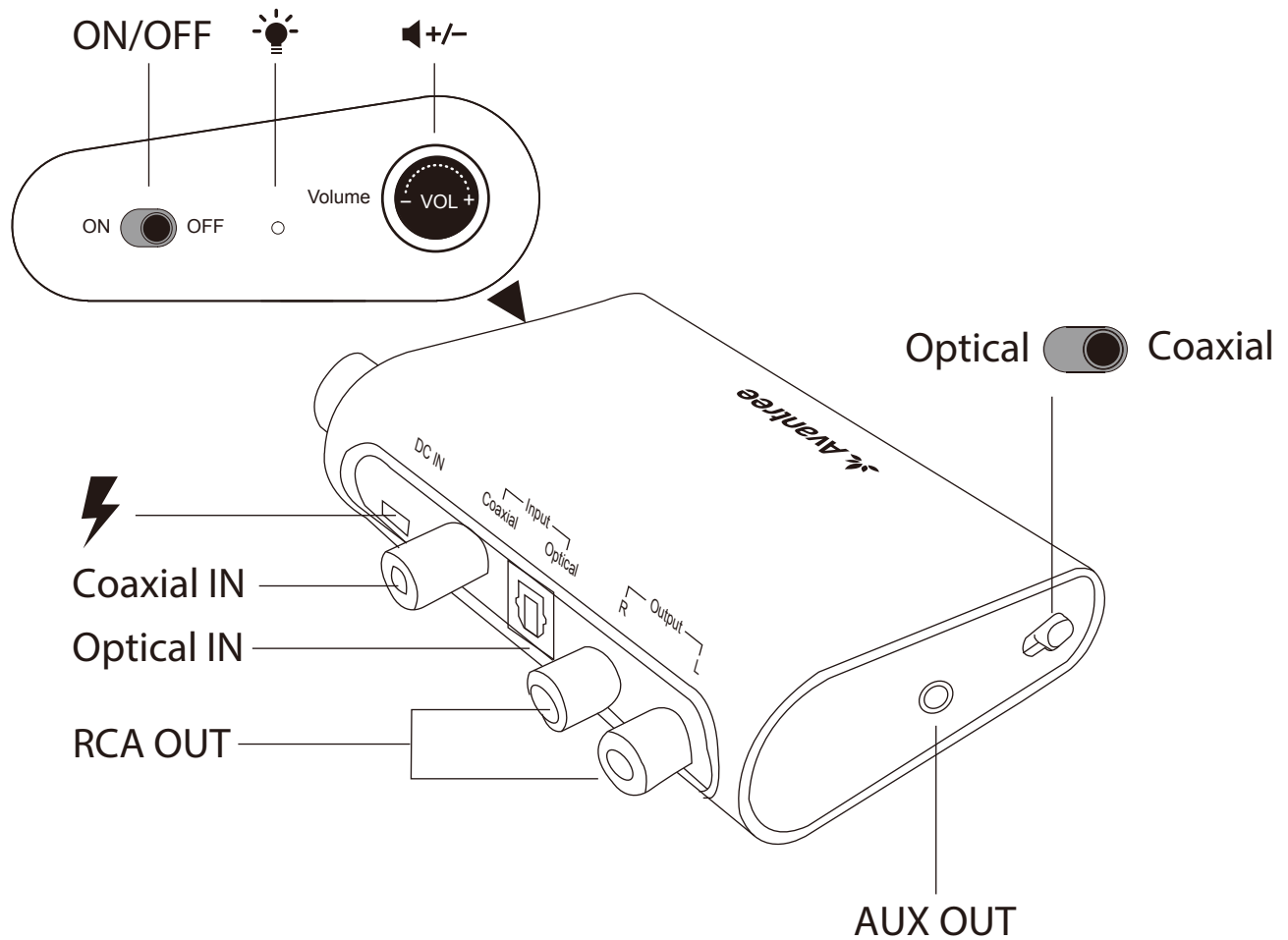

Power On

1. Connect the input port to a power source (TV USB socket or power adapter) with a micro USB cable.

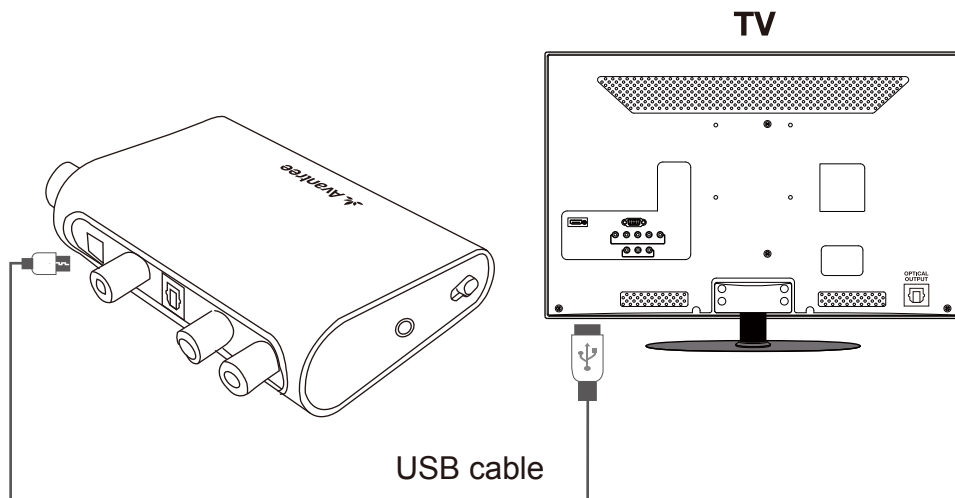

2. Slide the power switch to the "ON" position - the power indicator should turn green.

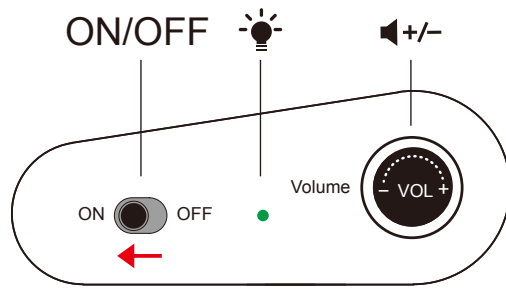

Cable Connection

1. Connect the Coaxial input port or the Optical input port on the DAC02 to your audio source's output with the corresponding cable. Use the input selector switch to choose the input type (coaxial or optical).

Use with Coaxial cable

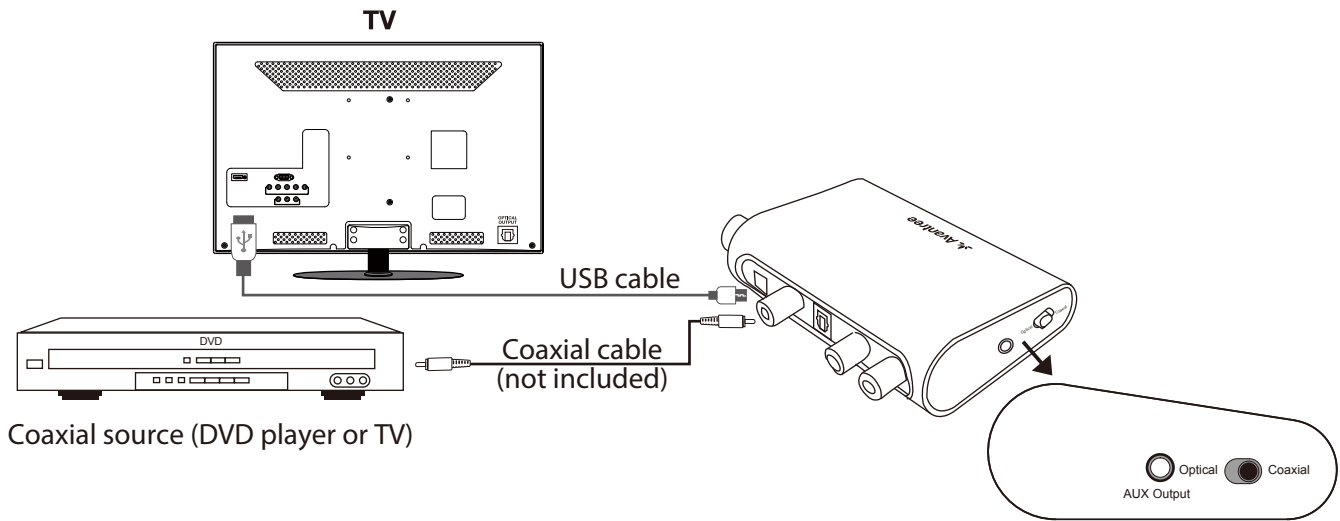

Use with Optical cable

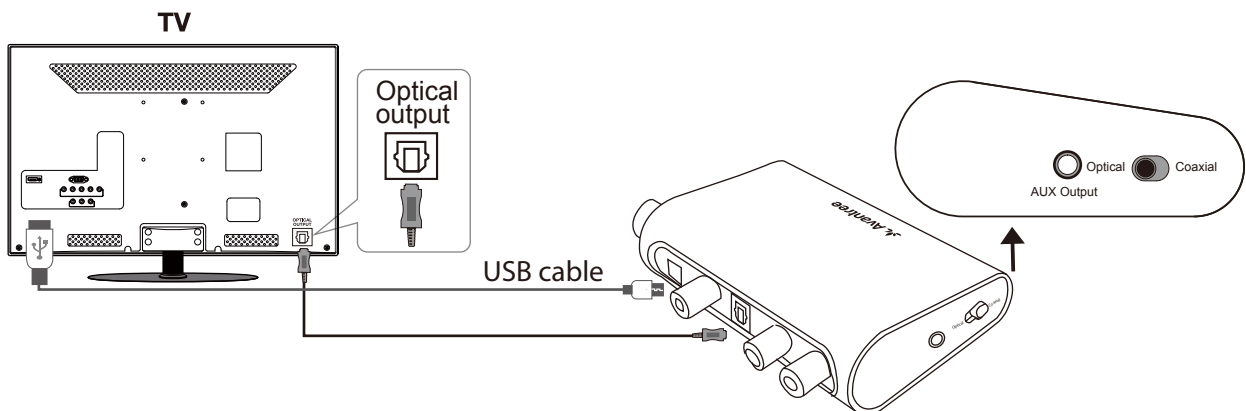

2. Connect your speaker/headphones to either the RCA or AUX Output port using an RCA/3.5mm audio cable (Not Included).

Connect to speaker with RCA port

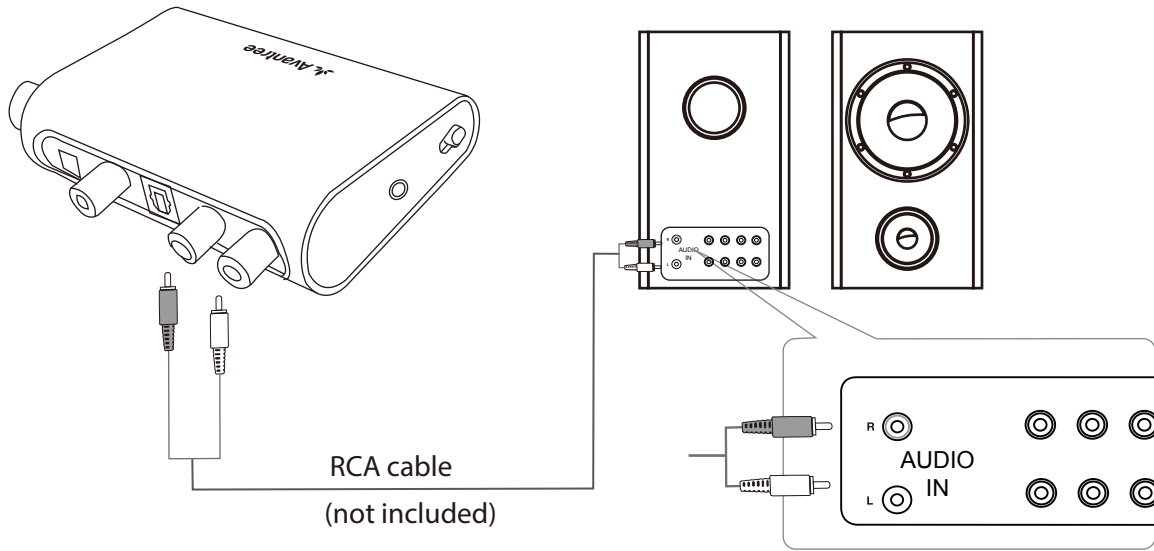

Connect to headphones with AUX port

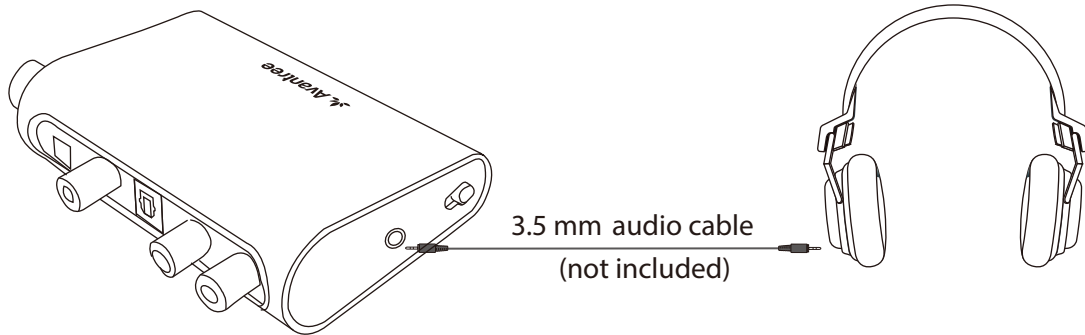

Notes: The DAC02 can simultaneously support 2 active output ports (for example to use a speaker and a headphone at the same time). Adjust volume using the volume knob.

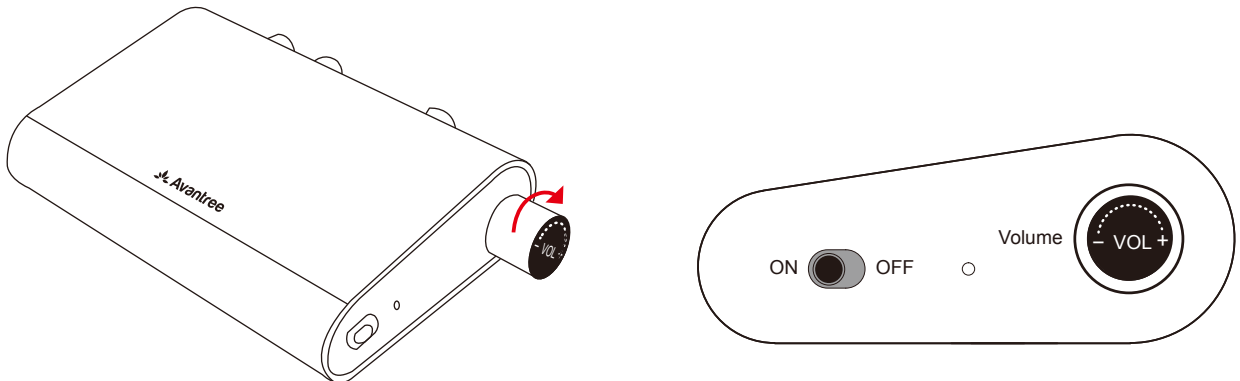

TV Setting

1. Change your TV audio format to "PCM" or "LPCM"

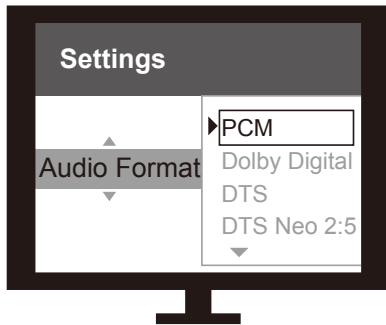

2. Make sure your TV audio OUTPUT setting is changed from TV speaker to "External Speaker" or "External Speaker (optical)".

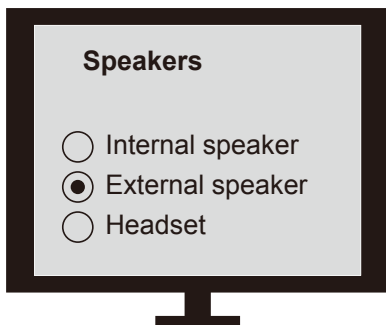

Troubleshooting

There's no sound? It's not working?

Please check the following:

1. This item doesn't support compressed digital audio formats like Dolby or DTS, please set your TV/Blu-Ray/DVD/CD player's audio format to "PCM/LPCM".

E.g. Settings | Options | Menu > Sound > Audio Format (menu depends on TV brand/model)

2. Change your TV's audio OUTPUT setting from TV speaker to "External Speaker" or "External Speaker (optical)".

E.g. Settings | Menu | Option > Sound > Speakers > External Speaker / External Speaker (optical) (menu depends on TV brand/model).

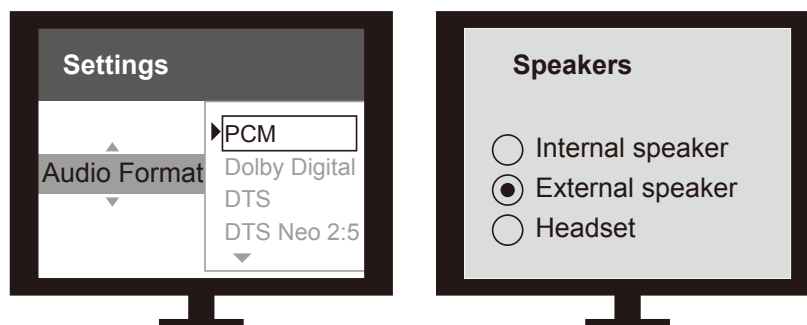

3. Ensure the correct input type is selected. Slide input selection switch on DAC02 to "optical" or "coaxial".

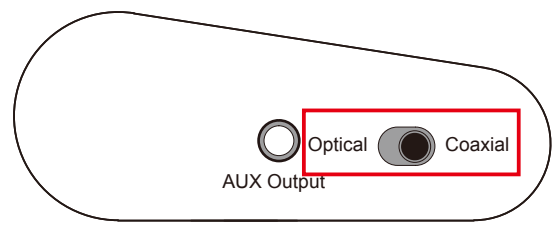
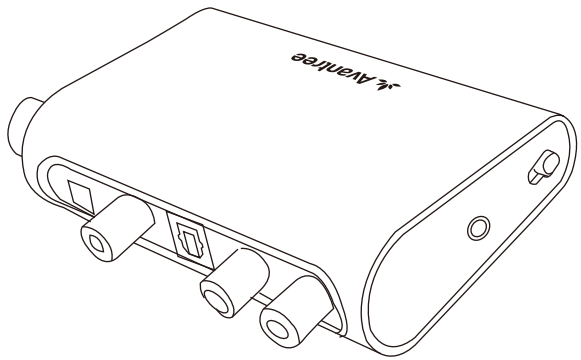

4. The power indicator of DAC02 should be ON. If not, check that the DAC02 is connected to a USB power source and slide the power switch to the "ON" position.

