Wireless Service Provider Solutions

BTS18000 Reference Manual

Document number: PE/DCL/DD/0160
411-9001-160
Document status: Preliminary
Document issue: 15.01/EN
Product release: GSM/BSS V15.0.1
Date: October 2004

[Welcome screen](#)

[Table of contents](#)

[List of figures](#)

[List of tables](#)

Copyright © 2002-2004 Nortel Networks, All Rights Reserved

Originated in France

NORTEL NETWORKS CONFIDENTIAL:

The information contained in this document is the property of Nortel Networks. Except as specifically authorized in writing by Nortel Networks, the holder of this document shall keep the information contained herein confidential and shall protect same in whole or in part from disclosure and dissemination to third parties and use for evaluation, operation and maintenance purposes only.

You may not reproduce, represent, or download through any means, the information contained herein in any way or in any form without prior written consent of Nortel Networks.

The following are trademarks of Nortel Networks: *NORTEL NETWORKS, the NORTEL NETWORKS corporate logo, the NORTEL Globemark, UNIFIED NETWORKS, S8000, S12000, BTS18000. GSM is a trademark of France Telecom. Windows is a U.S. registered trademark of Microsoft Corp.

All other brand and product names are trademarks or registered trademarks of their respective holders.

PUBLICATION HISTORY

System release: GSM/BSS V15.0.1

September 2004

Issue 15.01/EN Preliminary

Creation for feature 25808 - BTS18000 introduction ready.

About this document	0-1
Applicability	0-1
Audience	0-1
Prerequisites	0-1
Related Documents	0-1
How this document is organized	0-2
Vocabulary conventions	0-2
Regulatory information	0-3
1 BTS18000 overview	1-1
1.1 Key market trends	1-1
1.1.1 Operating expenses savings	1-1
1.1.2 Advent of new technologies	1-1
1.1.3 Investment protection	1-2
1.1.4 Network coverage	1-2
1.2 Nortel Networks BTS portfolio	1-3
1.2.1 Nortel Networks BTS18000 solution	1-3
1.2.2 BTS18000 positioning in Nortel Networks BTS portfolio	1-4
1.3 BTS18000 offer	1-6
1.3.1 BTS18000 versions	1-6
1.3.2 BTS18000 possible uses	1-6
2 BTS18000 functionality	2-1
2.1 GSM-UMTS dual technology proposal	2-1
2.2 GSM features	2-1
2.3 GSM functions	2-3
3 BTS18000 hardware	3-1
3.1 Description of the cabinets	3-1
3.1.1 BTS18000 outdoor cabinet layout	3-1
3.1.2 BTS18000 indoor cabinet layout	3-2
3.1.3 Power supply (outdoor cabinet)	3-4
3.1.4 Cooling system	3-4
3.1.5 Physical characteristics and environmental requirements	3-5
3.2 Description of the modules	3-7
3.2.1 Interface Back Plane (IBP), Digital Back Plane (DBP) and Radio InterConnect board (RICO)	3-7

3.2.2	Radio Module (RM)	3-7
3.2.3	High Power Radio Module (HPRM)	3-11
3.2.4	Interface Control Module (ICM)	3-11
3.2.5	Interface Module (IFM)	3-19
3.2.6	Spare Module (SPM)	3-19
3.2.7	Alarms and Bridge Module (ABM)	3-19
3.2.8	Dual Duplexer Module (DDM) and Transmit Filter (TXF)	3-23

□

8	MCPA BTS18000 configurations	8-1
8.1	MCPA BTS18000 overview	8-1
8.2	MCPA BTS18000 hardware	8-1
8.2.1	Description of the MCPA BTS18000 outdoor cabinet	8-1

	8.2.2	Description of the MCPA BTS18000 specific modules	8-3
8.3		MCPA cabinet	8-6
	8.3.1	MCPA rack overview	8-6
	8.3.2	DLNA module overview	8-7
	8.3.3	DLNA RF features	8-8
	8.3.4	VSWR meter	8-8
	8.3.5	MCPA cabinet alarm monitoring	8-9

Figure 1-1	BTS18000 positioning	1-4
Figure 3-1	BTS18000 outdoor equipped cabinet with door opened (front view)	3-2
Figure 3-2	BTS18000 indoor equipped cabinet with door opened (front view)	3-3
Figure 3-3	RM front panel	3-8
Figure 3-4	BTS18000 corporate LEDs for RM, ICM and ABM	3-9
Figure 3-5	ICM front panel	3-12
Figure 3-6	ICM Abis switch	3-15
Figure 3-7	ICM SW10 switch	3-17
Figure 3-8	ICM SW11 switch	3-18
Figure 3-9	ABM front panel	3-21
Figure 3-10	DDM front panel (with H2 coupling option)	3-23
Figure 3-11	DDM LEDs and switches details	3-24
Figure 3-12	TXF front panel (with H2 coupling option)	3-26

Figure 8-1	MCPA BTS18000 outdoor equipped cabinet with door opened (front view).	8-2
Figure 8-2	MBM front panel.	8-4
Figure 8-3	BTS18000 corporate LEDs for MBM, CM and ABM.	8-4
Figure 8-4	MCPA BTS18000 MCPA cabinet digital links overview (configuration with three MCPA racks).	8-10
Figure 8-5	MCPA BTS18000 MCPA cabinet digital links overview (configuration with six MCPA racks)	8-11

ABOUT THIS DOCUMENT

This document describes the new BTS18000 Base Transceiver Station (BTS), which is a component of the Base Station Subsystem (BSS).

Applicability

This document applies to the V15.0.1 BSS system release.

Audience

This document is intended for operation and maintenance personnel, and for any user who needs information relating to the BTS18000.

Prerequisites

It is recommended that the readers also become familiar with the following documents:

< 000 > : BSS Product Documentation Overview

< 001 > : BSS Overview

< 007 > : BSS Operating Principles

< 039 > : BSS Maintenance Principles

< 124 > : BSS Parameter Dictionary

< 125 > : Observation Counter Dictionary

< 128 > : OMC-R User Manual - Volume 1 of 3: Object and Fault menus

< 129 > : OMC-R User Manual - Volume 2 of 3: Configuration, Performance, and Maintenance menus

< 130 > : OMC-R User Manual - Volume 3 of 3: Security, Administration, SMS-CB, and Help menus

< 138 > : GSM BSS Engineering Rules

< 161 > : Fault Number Description: BTS18000

< 162 > : BTS18000 Maintenance Manual

Related Documents

The NTPs listed in the above paragraph are quoted in the document.

How this document is organized

Chapter 1 presents the new BTS18000 product and situates it in the Nortel Networks BTS portfolio.

Chapter 2 describes the BTS18000 functionality.

Chapter 3 describes:

- the layout and content of the BTS18000 cabinets.
- the functions of the BTS18000 boards and modules, as well as their front panels.

Chapter 4 describes the BTS18000 software.

Chapter 5 examines:

- the BTS18000 functional architecture,
- the BTS18000 hardware architecture.

Chapter 6 describes the GSM-UMTS dual mode configurations.

Chapter 7 describes the MCPA BTS18000 configurations.

Chapter 8 indicates that the dimensioning rules are now contained in NTP < 138 > GSM BSS Engineering Rules.

Vocabulary conventions

The glossary is included in the NTP < 000 >.

Regulatory information

This part which provides the regulatory information concerning the BTS is split into the following items:

- European regulatory requirement compliance,
- North American regulatory requirement compliance,
- Compliances for other regions/countries,
- Operation conditions,
- Cable specifications,
- Product labeling.

European regulatory requirement compliance

As a radio product, the Nortel Networks BTS18000 falls under the requirement of the RTTE (Radio and Telecom Terminal Equipment) European directive 1999/5/EEC. The RTTE directive covers essential requirements in the field of:

- protection of the Health and Safety of the user and any other person, including the objectives with respect to safety requirements contained in the Low Voltage directive (73/23/EEC).
- the protection requirements with respect to EMC contained in Directive 89/336/EEC.

The equipment generates, uses, and can radiate radio frequency energy. If not installed and used in accordance with the instruction manual, the equipment may cause harmful interference to radio communications. However, there is no guarantee that interference will not occur in a particular installation. If this equipment does cause harmful interference to radio or television reception, which can be determined by turning the equipment off and on, the user is encouraged to try to correct the interference.

The EMC requirements have been selected to ensure an adequate level of compatibility for apparatus at residential, commercial, and light industrial environments. The levels however, do not cover extreme cases which may occur in any location but with a low probability of occurrence. In particular, it may not cover those cases where a potential source of interference which is producing individually repeated transient phenomena, or continuous phenomena, is permanently present, for example a radar or broadcast site in the near vicinity. In such a case it may be necessary to either limit the source of interference, or use special protection applied, to the interfered part, or both.

Note: For operation or maintenance inside Nortel Networks systems, the antistatic wrist shall always be used to maintain the integrity of the product.

- effective use of the Radio spectrum allocated to terrestrial/space radio communication and orbital resources so as to avoid harmful interference. The routes and standards used to demonstrate compliance with these essential requirements are outlined in the following paragraphs.

- BTS EMC

Compliance with the essential requirements of EMC has been demonstrated using EN301489-1 & -23 standard.

- BTS radio compliance

Compliance with the essential requirements of effective use of the radio spectrum has been demonstrated using EN301908-1 & -3 standard.

- BTS safety

Compliance with the essential requirements of Safety has been demonstrated using EN 60950 Standard.

- BTS health protection

Compliance with the essential requirement of health requirement has been demonstrated using EN50385.

North American regulatory requirements compliance

The Nortel Networks BTS18000 has been qualified according to North American market requirements for the Outdoor and MCPA versions.

This equipment has been tested and found to comply with the limits for a Class B digital device, pursuant to part 15 of the FCC Rules. These limits are designed to provide reasonable protection against harmful interference in a residential installation. This equipment generates, uses and can radiate radio frequency energy and, if not installed and used in accordance with the instructions, may cause harmful interference to radio communications. However, there is no guarantee that interference will not occur in a particular installation. If this equipment does cause harmful interference to radio or television reception, which can be determined by turning the equipment off and on, the user is encouraged to try to correct the interference by one or more of the following measures:

- reorient or relocate the receiving antenna.
- increase the separation between the equipment and receiver.
- connect the equipment into an outlet on a circuit different from that to which the receiver is connected.
- consult the dealer or an experienced radio/TV technician for help.

- BTS safety

Nortel Networks BTS18000 complies with UL60950 and CAN/CSA C22.2 No. 60950-00 Safety Standards. The CSA mark is applied on the BTS and demonstrates compliance with both US and Canadian Standards.

- BTS EMC and radio compliance

Nortel Networks BTS18000 complies with 47CFR Part 15 class B and 47 CFR Part 24 for EMC and radio emission limits according to US regulatory requirements as indicated on the regulatory label.

- BTS interconnection compliance

The Nortel Networks BTS18000 complies with 47 CFR Part 68 of the FCC rules and the requirements adopted by the ACTA.

On the top right of this equipment is a label that contains, among other information, a product identifier in the following format: **US : AB6XDNANBTS18000**

If requested, the following information must be provided to the telephone company:

- FCC Registered Number: AB6.
- Facility Interface Code (FIC): 04DU9.BN, 04DU9.DN, 04DU9.1KN, and 04DU9.1SN.
- Service Order Code (SOC): 6.0F.

A FCC part 68 and ACTA compliant cable is provided with the BTS equipment, with no connector at network interface side. The BTS equipment operates with a 1.544 Mbps digital channel. See Installation Instructions for details.

If the BTS18000 equipment causes harm to the phone network, the telephone company will notify you in advance that temporary discontinuance of service may be required. But if advance notice is not practical, the telephone company will notify the customer as soon as possible. Also, you will be advised of your right to file a complaint with the FCC if you believe it is necessary.

The telephone company may make changes to its facilities, equipment, operations or procedures that could affect the operation of the equipment. If this happens the telephone company will provide advance notice so you can make the necessary modifications to maintain uninterrupted services.

If trouble is experienced with BTS18000 equipment, for repair or warranty information, please contact:

Toy-Brent Lorange Nortel Networks
2370D Performance Dr.
Richardson, TX 75082
Phone: 972-685-2270
Fax: 972-684-7601

If the equipment is causing harm to the telephone network, the telephone company may request that you disconnect the equipment until the problem is resolved.

All repairs should be handled by authorized Nortel Networks Service Personnel.

- BTS18000 data equipment

The following table shows which jacks are associated with which modes of operation.

Operation mode	USOC Jack
Programmable & Test	RJ45S

- BTS18000 systems

Facility Interface Codes (FIC), Services Order Codes (SOC), USOC Jack Codes, and Ringer Equivalence Number (REN) are shown in the table below for each port where applicable.

Port	FIC	SOC	USOC Jack	REN
ICM T1 board	04DU9.BN	6.0F	N/A	N/A
ICM T1 board	04DU9.DN	6.0F	N/A	N/A
ICM T1 board	04DU9.1KN	6.0F	N/A	N/A
ICM T1 board	04DU9.1SN	6.0F	N/A	N/A

- BTS18000 RF health protection

Compliance with the North American requirements is demonstrated through calculation according to FCC OET bulletin 65.

Compliances for other regions/countries

For countries outside Europe and the Americas, the requirements of European countries usually apply.

It is not possible to list all the applicable approvals/compliances as they will be dependent on the markets and products considered.

Note: Please contact your local Nortel Networks representative for more information.

Operational conditions

The aforementioned standards compliance of the products are based on the following operating conditions (called normal operation):

- doors shall be closed and (or) covers shall be in place.
- external cables shall be of the same type as specified by Nortel Networks.
- no modification of any mechanical or electrical characteristics of the product shall be made.

Any change or modification made to the product without written approval from Nortel Networks releases Nortel Networks from subsequent responsibility regarding the standards compliance.

Cable specifications

The compliance to the aforementioned standards has been verified using cables as specified by Nortel Networks. The continuing compliance of the product relies upon use of the correct cabling scheme as well as use of identical type cables as specified by Nortel Networks. Refer to the installation guides for details on cable specifications.

Product labeling

The label may be located inside or outside the product, provided that the operation and/or maintenance personnel have the information when working on the product.

- BTS labeling for American Countries

To indicate compliance with the CSA and UL Safety requirements, the Nortel Networks BTS18000 bears the following mark in a conspicuous location.



On the regulatory label, compliance to 47 CFR Part 15, 24 and 68 is stated along with:

- FCC ID, FCC Registration Number.
- Manufacturers name.
- Equipment designation.
- Nominal voltage operating range and maximum rated current.

- BTS labeling for European Countries

To indicate compliance with the European RTTE Directive, the Nortel Networks BTS18000 bears the following information in a conspicuous location:



- Manufacturers name.

- Equipment designation.
- Nominal voltage operating range and maximum rated current.

- Labeling for other regions / countries

Labeling for other regions and countries is performed as appropriate and required by the local regulatory framework.

1 **BTS18000 OVERVIEW**

1.1 **Key market trends**

1.1.1 **Operating expenses savings**

Most of the operators in Europe and Asia are going to install UMTS equipment on their networks, including UMTS radio cabinets. In most of the cases, these radio equipments will be co-located with existing GSM sites.

Moreover, as GSM capacity increases in urban areas (voice and data traffic), operators will need to install new radio transmitters and will be forced to limit the number of additional radio cabinets required to carry the increasing traffic, in order to contain the "floor investments" at an acceptable level.

This results in a need for a Base Transceiver Station (BTS) solution with a high number of transceivers per square meter, thus a cabinet which can house more TRXs in the same footprint than S8000 and S12000 cabinets. This results as well in the need for reduced power consumption, operational effectiveness, antenna tower loading.

1.1.2 **Advent of new technologies**

The existing GSM European operators are almost all planning the deployment of a 3G networks based on UMTS technology. Some of them have even started in 2001 but the massive deployment is just about to start.

In Asia, the scenario is almost the same and the Asian operators are also preparing for 3G (CDMA 2000 or UMTS).

In the Americas, the path to 3G for GSM operators is likely to stop off at GPRS/EDGE in a first stage with limited infrastructure investment before investing massively in 3G technology.

The challenge for these operators is to increase the capacity and complete the coverage of their GSM network while they are starting their investments in 3G infrastructure. This results into two major difficulties for the operators:

- Radio sites congestion.

Most of the urban sites are highly constrained by BTS footprint and will hardly accommodate for both 3G and increased capacity GSM/GPRS base stations. Therefore, dense and compact GSM and UMTS product solutions are required to answer to this constraint.

- Financing and cash flow.

Investing in a new technology (3G), while break in GSM has not been reached, will require very cost-effective product solutions. GSM radio sites will be reused. Some solutions, as dual mode UMTS/GSM base stations and/or infrastructure sharing between 3G operators, will allow cost-effectively launching UMTS services, before smoothly migrating the subscriber base from GSM to UMTS.

This results in a need for a BTS solution supporting both GSM and UMTS.

1.1.3 Investment protection

Most of the GSM operators are facing the challenges to increase the capacity and coverage of their existing networks as traffic is growing, and in the same time start to invest in new UMTS network elements and buy expensive licenses. As a consequence, the protection of the operators' existing investments while they invest in new network components is becoming more and more important to preserve their business profitability.

This results in a need for a BTS solution which should offer the maximum of compatibility with the existing S8000 and S12000 BTSs installed on the field (e.g. possibility to expand existing sites).

1.1.4 Network coverage

GSM coverage is not everywhere today and the GSM operators will complete the coverage of their network in the coming years, mainly in not very dense and rural areas.

This results in the need for a very cost-effective, low capacity solution, offering high coverage capabilities in order to limit the investment and balance the business case of the operator for the low revenue generating areas.

1.2 Nortel Networks BTS portfolio

Combined with Nortel Networks' experience gained through manufacturing and delivering more than 540,000 DRX and 100,000 BTS to more than 54 countries and 100 operators throughout the world, the DRX-based family of BTS products provides the operator with the key ingredients required to minimize both:

- the initial and ongoing infrastructure investment,
- the ongoing operating expenses.

The Nortel Networks family of BTS products offers the flexibility of high performance and dense packaging needed to provide the operator with optimum network solutions.

This BTS portfolio benefits from Nortel Networks' vast experience in spectrum management and network engineering.

1.2.1 Nortel Networks BTS18000 solution

The new BTS18000 is the Nortel Networks solution for all needs previously described in *section 1.1*.

Nortel Networks new dual technology BTS18000:

- leverages the latest capabilities that our UMTS and GSM/GPRS/EDGE portfolios have to offer,
- provides a flexible deployment platform for the rollout of UMTS services to meet customer demand.

All this provides operators with a mean to control timing and costs for new UMTS deployments.

The BTS18000's flexibility also allows operating in a GSM-only mode that offers, in a single cabinet, omni-directional O16 or tri-sectorial S666 capacities and is scalable to a three cabinet site supporting a tri-sectorial S16.16.16 capacity.

1.2.2 BTS18000 positioning in Nortel Networks BTS portfolio

Although a particular attention is paid on the high capacity configurations, the BTS18000 is intended to cover almost all environments, from small towns (S111 type of configurations) up to indoor coverage (S16.16.16 and MCPA configurations).

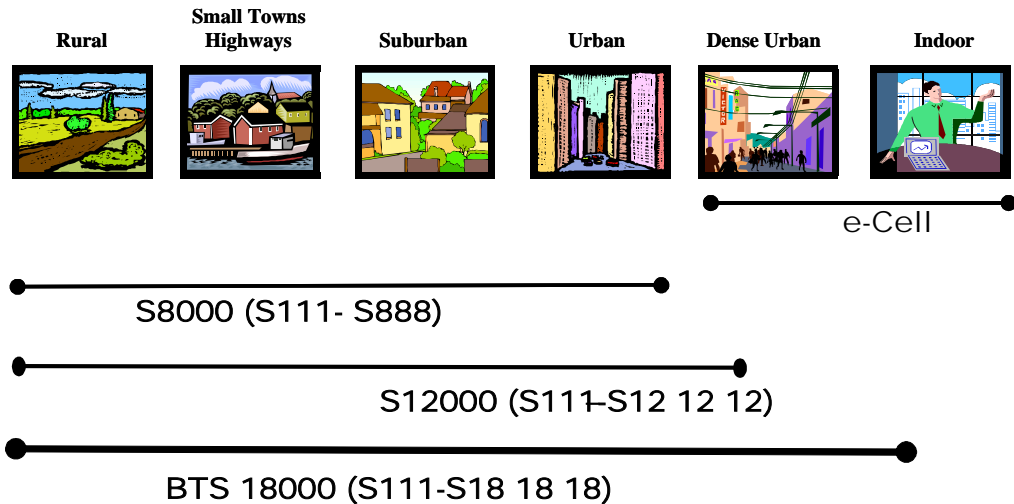

Figure 1-1 BTS18000 positioning

In addition, the BTS18000 provides 3G evolution and GSM/EDGE Radio Access Network (GERAN) readiness to Nortel Networks GSM macro base station portfolio.

The Nortel Networks BTS portfolio includes the products listed below.

1.2.2.1 BTS18000

This new family of BTS is based on a new highly integrated Radio Module (RM) that provides the equivalent of three GSM/GPRS/EDGE transceiver channels including power amplifier function. This represents further integration of the successful single module DRX approach for the receiver, transmitter and frame processor, used in Nortel Networks legacy S8000 and S12000 BTSs.

The BTS18000 is an ideal site solution for operators:

- that have well established GSM networks evolving to EDGE, with a need for high density BTS in urban deployments,
- that are planning new hybrid GSM/UMTS networks enabling more advanced data services traffic.

These hybrid networks offer the ultimate balance of GSM and UMTS without any compromises. The inherent flexibility of the new BTS is the catalyst to accelerate today's investment decision needed to secure the operator's success today and tomorrow.

The BTS18000, which represents unprecedented capacity and flexibility, can provide up to 54 TRX, with 18 TRX per sector, using only three cabinets.

1.2.2.2 S8000 BTS

The S8000 is a high performance BTS designed for macro-cellular voice and data applications, that has a high modularity and expansion capability providing site configurations ranging from 1 TRX to 8 TRX per sector in a tri-sectorial site, or up to 16 TRX in an omni-directional configuration.

Because of its superior RF performance (high receiver sensitivity, interference cancellation) and unique frequency re-use features, the S8000 BTS is an excellent product that delivers wide coverage and optimizes spectrum efficiency. The S8000 BTS indoor version is designed for protected sites, while the outdoor version is a fully integrated BTS site with AC power supply and extended temperature range.

1.2.2.3 S12000 BTS

The S12000 BTS is a twelve-transceivers, high-capacity solution designed to meet the increasing traffic demand on macro cellular voice and future data applications.

The S12000 BTS can provide up to 36 TRX at a single site with 12 TRX per sector using only three cabinets.

The S12000 BTS inherits the superior RF performances, unique features and main modules of the S8000 BTS market-proven technology.

The modular design of S12000 BTS and the possibility to choose between multiple RF-combining options allows the operator to deploy the S12000 solution in a number of different scenarios such as a high-capacity solution in cities or alternatively enabling to provide wide-coverage with a minimum number of sites in rural areas. The S12000 BTS indoor version is designed for protected sites, while the outdoor version is a fully integrated BTS site with AC power supply and extended temperature range.

1.2.2.4 e-cell BTS

The e-cell BTS is the micro-BTS from Nortel Networks with a very light and compact design. It is quick and easy to install. The e-cell unit includes two transceivers and can be easily extendible to a synchronized four-transceiver BTS. It is EDGE-ready and provides an ideal solution for indoor deployment as part of a micro cellular underlay, or for in-building coverage.

1.3 BTS18000 offer

1.3.1 BTS18000 versions

The BTS18000 is proposed in standard into two main versions:

- BTS18000 indoor,
- BTS18000 outdoor.

In addition to the two standard indoor and outdoor versions, the BTS18000 is proposed in two variants:

- Combo GSM/UMTS dual mode variant, proposed in indoor and outdoor version,
- MCPA variant, with increased number of TRXs per cabinet used in conjunction with MCPA cabinet, proposed in outdoor version.

1.3.2 BTS18000 possible uses

The BTS18000, which is meant for various operating environments:

- complements the S8000 or S12000 BTSs in Nortel Networks portfolio for greenfield site deployments.
- provides continuity to the S8000 and S12000 BTSs by its ability to be operated in a synchronized co-location mode, to increase the capacity of existing S8000 or S12000 sites.

2 BTS18000 FUNCTIONALITY

2.1 GSM-UMTS dual technology proposal

The BTS18000 is designed to integrate, within the same cabinet, both GSM/GPRS/EDGE and UMTS technologies.

This configuration is available on all GSM frequency variants (850, 900, 1800, and 1900 MHz) and on both 1900 and 2100 MHz frequency variants for UMTS. The maximum one-cabinet configuration is GSM S333 + UMTS STSR-2.

This configuration can support up to two additional GSM extension cabinets of 18 TRX. The maximum three-cabinet configuration is GSM S15.15.15 + UMTS STSR-2.

2.2 GSM features

The BTS18000 offers a set of features enhancing the Quality of Service and the spectrum efficiency of the network such as:

- Full support of GPRS data services.
- Full support of EDGE 8PSK modulation.
- Guaranteed -110 dBm dynamic single-branch receive sensitivity (GMSK modulation) at the BTS antenna, without any tower-mounted Low Noise Amplifier (LNA).
- Improved receiver diversity gain using a Nortel Networks specific algorithm, providing 5 dB or more diversity gain in most situations, when spatial diversity and de-correlated antennas are used.
- High output power with a 30W or 45W standard Power Amplifier (PA), and an optional 60W High Power Amplifier.

The BTS18000 cabinet can also be used as a very high density BTS in conjunction with an optional cabinet housing Multi Carrier Power Amplifiers (MCPA) and TX/RX antenna combiners.

The MCPA feature allows high radio capacities using fewer RF feeders (8-Carriers per feeder at 43 dBm) and antennas:

- without the coverage penalties of hybrid combiner solutions,
- without the frequency hopping limitations of cavity combiner solutions.

The MCPA feature leads to a S16.16.16 configuration in two BTS cabinets and one MCPA cabinet. The BTS18000 cabinet then contains up to 27 TRX without power amplification. This BTS configuration is ideal for urban deployment with severe space limitations and high capacity demands without compromising radio coverage.

- Dual-band GSM configurations with single-BCCH, built in a single or in multiple BTS18000 cabinets.
- Enhanced voice quality due to an innovative algorithm of interference cancellation significantly reducing the end-user's perception of errors generated in the radio transmission.
- Full RF power control range (static and dynamic).
- Spectrum efficiency optimization with the support of the undisputed Nortel Networks capacity features that provide high quality voice and data services to a dense subscriber population, in a limited spectrum and at competitive cost.

These solutions include Fractional Frequency Reuse, Automated Cell Tiering and Adaptive Multi Rate (AMR) support.

- Best-in-class radio performance thanks to high sensitivity receivers, unique interference cancellation and improved spatial diversity algorithms along with high output power, providing optimum coverage and link quality for both data and voice services.
- High integration of advanced technology.

This in turn contributes to a significant reduction in required floor space, size and equipment operating costs. This concept is adapted to stringent environmental constraints and is leading to the best economic trade-off between initial and final capacity.

In addition, the BTS18000 supports asymmetrical radio configurations such as S963.

- Compatibility with the S8000 and S12000 BTSs:
 - through existing site synchronized co-location,
 - through the possibility to re-use existing site equipment (such as an S8000/S12000 outdoor plinth).
- Industry leading transmission solution including high signaling concentration on the Abis interface and drop-and-insert capability.

As an example, a single timeslot is only required for carrying the signaling of a S333 BTS.

- GSM/GPRS/EDGE and UMTS dual technology capabilities for operator evolution to 3G data services.

2.3 GSM functions

The BTS18000 provides:

- the radio interface with the mobile handsets,
- the associated signal processing and the transmission interface with the Base Station Controller (BSC).

The BTS18000 ensures the following main functions:

- RF functions:
 - Antenna coupling and duplexing,
 - Power amplification,
 - Reception, including RF 2-way receive diversity,
 - Gaussian Minimum Shift Keying (GMSK) modulation/demodulation,
 - 8-Phase Shift Keying (8-PSK) EDGE modulation/demodulation,
 - Synthesized frequency hopping in all hybrid coupling types.
- Radio channel management:
 - BTS and mobile handset power control,
 - Discontinuous Transmission and Voice Activity Detection (DTX/VAD), on both uplink and downlink paths,
 - Radio channel filling,
 - Call setup and release,
 - Mobile timing advance processing,
 - Support of Enhanced Full-Rate (EFR), Full-Rate (FR), AMR Full-Rate and AMR Half-Rate speech coding,
- Signal processing:
 - Channel encoding and decoding,
 - Encryption (A5/2 and A5/1),
 - Equalization,
 - Cancellation of interference,
 - Processing of radio measurements, including handover algorithms,
- Interface with the BSC:
 - Communication with the BSC,
 - Concentration of signaling on the Abis interface (a single PCM timeslot can concentrate signaling for up to nine transceivers),
 - Multiplexing of four traffic channels on one PCM slot (each TRX needs two PCM slots for traffic),

- Dynamic Abis for EDGE traffic,
- Optional optical OC-3/STM-1 connectivity.
- Switching:
 - Connection between the PCM links and the traffic/signaling channels,
 - Management of drop-and-insert connections,
 - Management of the TRX and PCM link redundancy.
- Operation and Maintenance:
 - High level of availability through optional duplication of switching, synchronization and control unit (working in active/stand-by mode) and optional N+1 redundancy for rectifiers and RM,
 - Monitoring of internal and external alarms, through internal bus and alarm loops,
 - Remote configuration management from the BSC (site, sector, Abis, TRX),
 - Remote software downloading.

3 BTS18000 HARDWARE

3.1 Description of the cabinets

This section presents the BTS18000 cabinet layout for both outdoor and indoor versions.

For the outdoor version as well as for the indoor version, the BTS18000 cabinet includes two shelves (see *Figure 5-3* of *Chapter 5* for a functional view of these two shelves). Each shelf contains:

- one combiner rack,
- one digital rack.

3.1.1 BTS18000 outdoor cabinet layout

The BTS18000 outdoor BTS can be housed in one or several cabinets depending on the required capacity:

- Only one cabinet is required (base cabinet), if the GSM capacity does not exceed:
 - 18 TRX, in GSM-only mode,
 - 9 TRX, in GSM-UMTS dual mode.
- Up to two additional extension cabinets can be added. Each extension cabinet can support up to 18 TRX.

The BTS18000 outdoor cabinet includes the following elements:

- outdoor enclosure including AC Distribution Unit (ADU),
- AC/DC power supply: Univity Compact Power System (UCPS),
- Environmental Control Unit (ECU),
- User Rack space and its associated User ICO,
- back-planes and ICO: Interface Back-Plane (IBP), Digital Back-plane (DBP), Radio InterConnect board (RICO),
- up to two Interface Modules (IFM),
- one Interface Control Module (ICM) or two ICMs (in an active/passive configuration, also called configuration with redundancy),
- up to two SPare Modules (SPM),
- up to two Alarm and Bridge Modules (ABM),
- up to six Radio Modules (RM),
- up to six Dual Duplexer Modules (DDM) with Voltage Standing Wave Ratio (VSWR) meter.

Figure 3-1 presents the BTS18000 outdoor cabinet layout and situates the modules in a fully equipped cabinet.

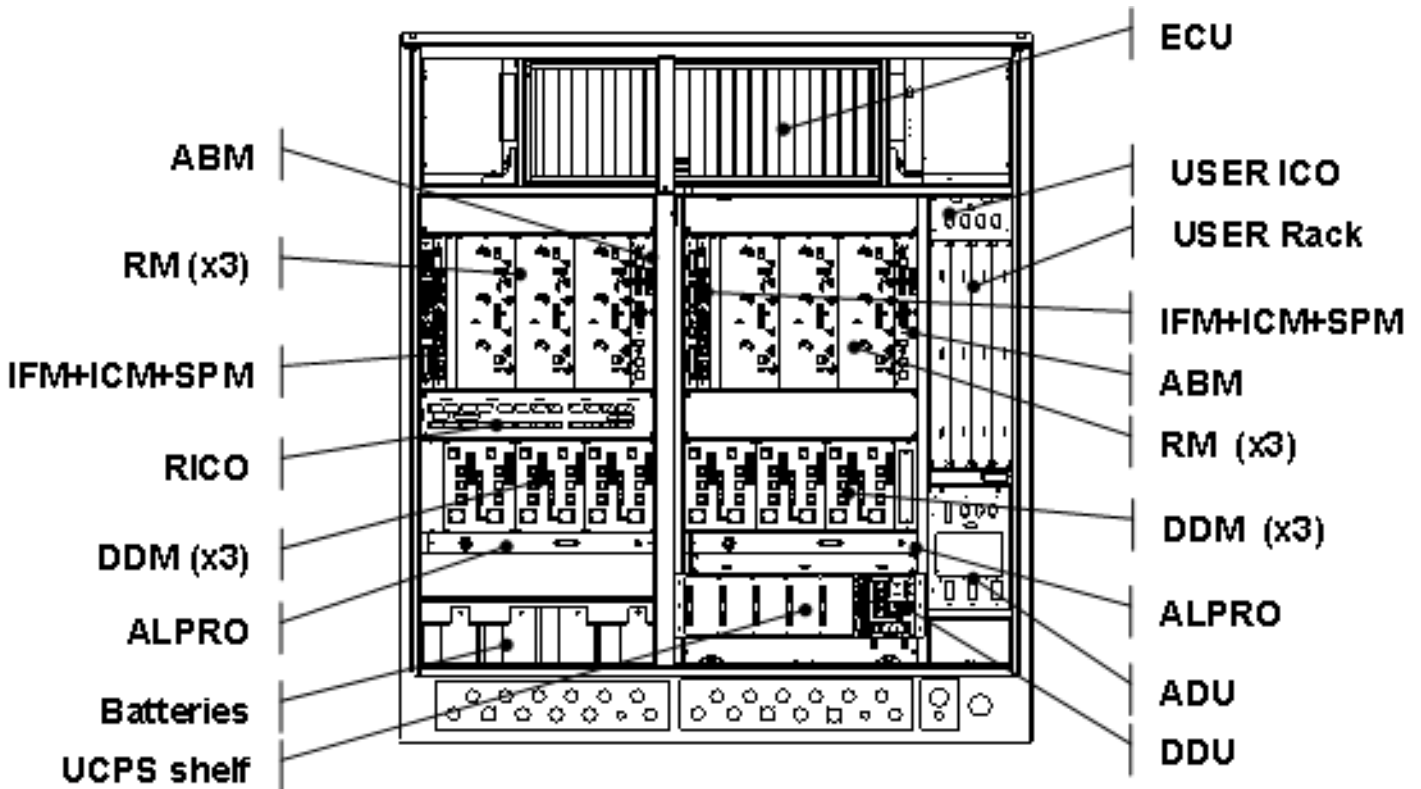

Figure 3-1 BTS18000 outdoor equipped cabinet with door opened (front view)

Note: The DDM modules are physically grouped into the two combiner racks. Each digital rack consists of the association of IFM, ICM, ABM, SPM and RM modules.

Note: IFM, ICM and SPM modules are not required in a BTS18000 extension cabinet.

3.1.2 BTS18000 indoor cabinet layout

The BTS18000 indoor cabinet includes the following elements:

- indoor enclosure,
- DC breaker panel,
- BTS18000 Integrated Cooling System (SICS),

- back-planes and ICO: Interface Back-Plane (IBP), Digital Back-plane (DBP), Radio InterConnect board (RICO),
- up to two Interface Modules (IFM),
- one Interface Control Module (ICM) or two ICMs (in an active/passive configuration),
- up to two SPare Modules (SPM),
- up to two Alarm and Bridge Modules (ABM),
- up to six Radio Modules (RM),
- up to six Dual Duplexer Modules (DDM) with VSWR meter.

Figure 3-2 presents the BTS18000 indoor cabinet layout and situates the modules in a fully equipped cabinet.

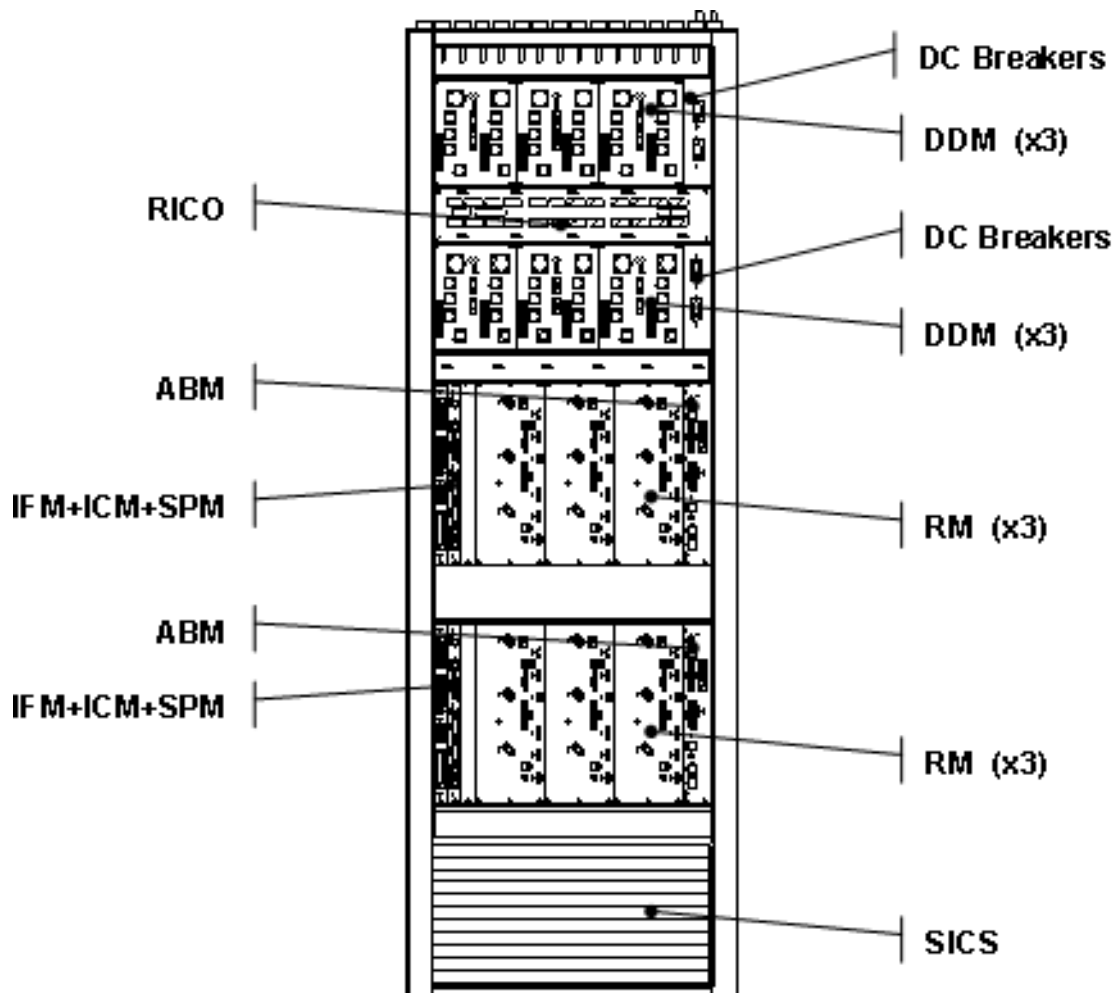

Figure 3-2 BTS18000 indoor equipped cabinet with door opened (front view)

3.1.3 Power supply (outdoor cabinet)

The outdoor cabinet provides an AC input. The AC Distribution Unit (ADU) performs AC protection, filtering and distribution.

The UCPS power supply system delivers -48V DC voltage from the AC input.

The UCPS includes:

- the rectifiers,
- the DC Distribution Unit (DDU),
- the Cabinet Control Unit (CCU).

3.1.4 Cooling system

3.1.4.1 BTS18000 outdoor cabinet

The outdoor cabinet design integrates the Environmental Control Unit (ECU). This unit is installed at the top of the cabinet.

3.1.4.2 BTS18000 indoor cabinet

The indoor cabinet design integrates the BTS18000 Indoor Cooling System (SICS). This system is installed at the bottom of the cabinet, and accessed through an access lift off panel.

An electronic monitoring unit controls the cooling functions of the SICS.

This unit:

- senses the internal cabinet air temperature and the external ambient air temperature,
- then selects the level of environmental control required to maintain full operational performance of the electronic equipment installed within the indoor cabinet.

3.1.5 Physical characteristics and environmental requirements

3.1.5.1 BTS18000 outdoor cabinet

As shown in *Table 3-1*, the weights and dimensions of the BTS18000 outdoor cabled cabinet allows for installations using generally available installation tools and methods. Key construction features are:

- Cabled cabinet design integrating all mechanical sub-racks and mechanical support systems required for the installation, transport and operation of the GSM wireless equipment.
- Centralized single Environmental Control Unit (ECU), supplying standardized cooling performance regardless of BTS configuration.
- AC Distribution Unit (ADU).
- Standardized AC/DC distribution system, allowing BTS minimum to maximum configuration expansion: Univity Compact Power System (UCPS).
- Standardized Radio InterCOnection module (RICO), allowing minimum to maximum BTS configuration expansion.
- Standardized digital back-plane assembly, allowing minimum to maximum BTS configuration expansion.

Outdoor cabinet	Height mm	Width mm	Depth mm	Weight Kg
BTS18000 pre-cabled cabinet	1500	1350	735	180
BTS18000 fully equipped cabinet	1500	1350	735	450

Table 3-1 **BTS18000 outdoor dimensions and weights**

The BTS18000 outdoor cabinet is designed to support an external temperature range of -40°C to +50°C with an absolute humidity between 1 g/m³ and 36 g/m³.

The BTS18000 enclosure is designed for an outdoor environment.

Combo GSM-UMTS and MCPA variants of BTS18000 outdoor cabinet support the same environmental conditions.

3.1.5.2 BTS18000 indoor cabinet

As shown in the *Table 3-2*, the weight and dimensions of the BTS18000 indoor cabled cabinet allows for installations using generally available installation tools and methods. Key construction features are:

- Cabled cabinet design integrating all mechanical sub-racks and mechanical support systems required for the installation, transport and operation of the GSM wireless equipment.
- Centralized single low acoustic noise BTS18000 Indoor Cooling System (SICS), supplying standardized cooling performance regardless of BTS configuration.
- Standardized DC distribution system, allowing BTS minimum to maximum configuration expansion.
- Standardized Radio InterCONNECTION module (RICO), allowing minimum to maximum BTS configuration expansion.
- Standardized digital back-plane assembly, allowing minimum to maximum BTS configuration expansion.

Indoor cabinet	Height mm	Width mm	Depth mm	Weight Kg
BTS18000 fully equipped cabinet	1750	600	600	300

Table 3-2 BTS18000 indoor dimensions and weight

The BTS18000 indoor cabinet is designed to support an external temperature range of -5°C to +45°C with an absolute humidity between 1 g/m³ and 29 g/m³.

The BTS18000 enclosure is designed for a standard indoor environment.

Combo GSM-UMTS variant of BTS18000 indoor cabinet supports the same environmental conditions.

3.2 Description of the modules

This section:

- lists the modules,
- introduces their function,
- illustrates their front panel (including LEDs),
- gives the LEDs behavior for ICM, RM and ABM,
- indicates the required configuration of the ICM, DDM and TXF switches for BTS18000 commissioning.

3.2.1 Interface Back Plane (IBP), Digital Back Plane (DBP) and Radio InterConnect board (RICO)

3.2.1.1 Interface Back Plane (IBP) and Digital Back Plane (DBP)

The IBP and the DBP provide the electrical interfaces that support DC power distribution and communication between all digital and radio modules.

All modules and some cables carrying external signals are plugged into connectors mounted on the backplanes printed-circuit board.

IBP and DBP are common to indoor and outdoor cabinets, and are field replaceable.

3.2.1.2 Radio InterConnect board (RICO)

The RICO provides the electrical interfaces that support DC power distribution and communication between all radio coupling modules and ABM, using front panel cables.

3.2.2 Radio Module (RM)

3.2.2.1 Function

The RM is a complete GSM/GPRS/EDGE transmitter/receiver. The RM is in charge of all processing related to the GSM TDMA. It is designed to support three TDMA (GSM or EDGE). It is logically equivalent to three TRXs.

The RM may operate:

- on a one-sector basis (three carriers per sector, O3 mode),
- on a three-sector basis (one carrier per sector, S111 mode).

The RM includes the following elements:

- a Power Supply Unit (PSU) delivering, from the 24/48V main power supply, the secondary supplies (27V, 3.3V, 5.7V) to the other blocks of the RM,
- the RF RX board (RM RX), three dual narrowband receiver chains (main and diversity),
- the RF TX board (RM TX), three low level transmit drivers,
- the RF PA board (RM PA), three Power Amplifier (PA) lines up,
- the Logic Radio Module (LRM), the digital control board.

3.2.2.2 Front panel

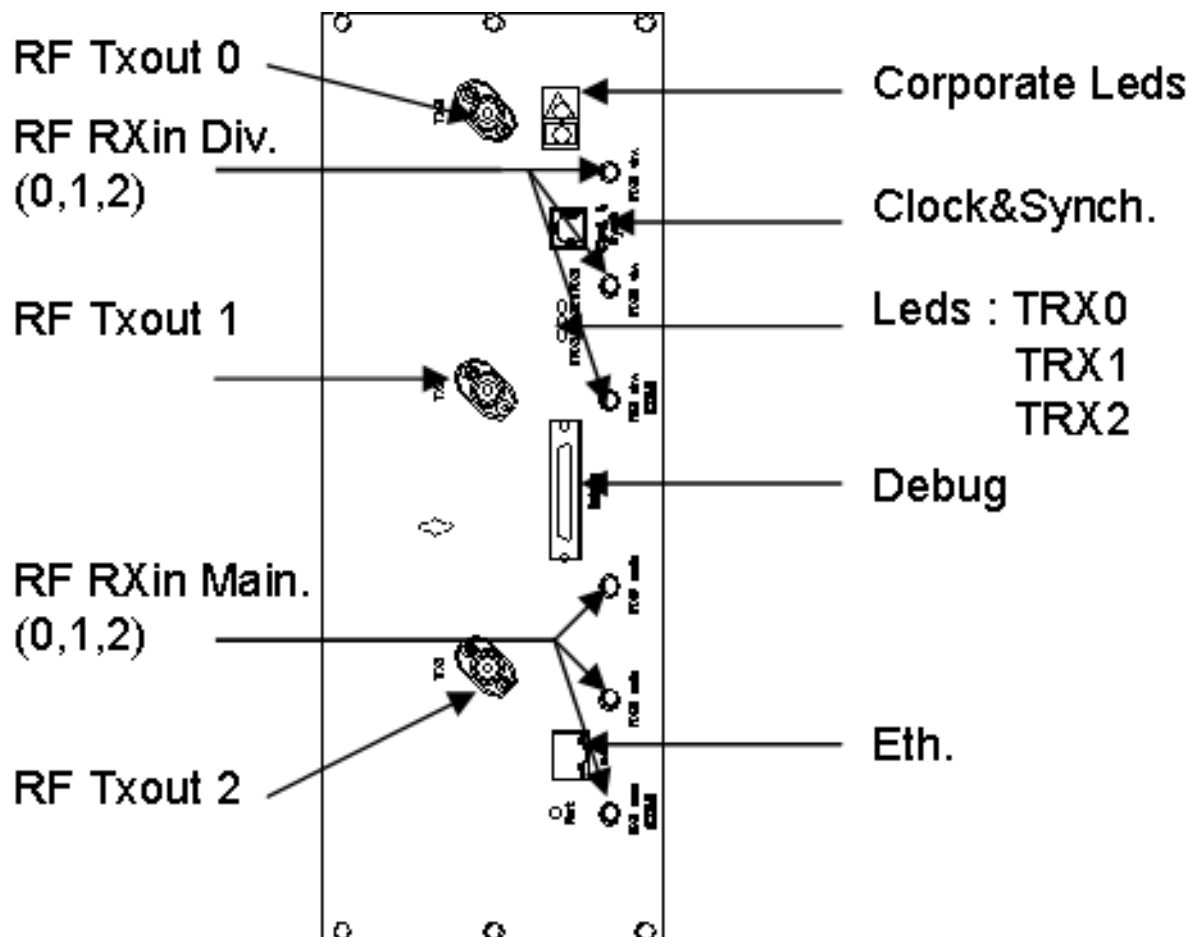

Figure 3-3 RM front panel

3.2.2.3 BTS18000 corporate LEDs behavior

As shown on *Figure 3-4*, an upper triangle-shaped red LED and a lower rectangle-shaped green LED are used to indicate the status for the RM, as well as for the ICM and ABM modules. See *Table 3-3* for detailed status information.

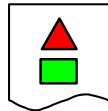

Figure 3-4 BTS18000 corporate LEDs for RM, ICM and ABM







Green LED	Red LED	Module status	ICM	RM	ABM
switched off	switched off	un-powered or not inserted (default hardware value)	used	used	used
		starting, BISTs in progress	used	used	used
	switched off	module OK (should not be removed)	used	used	used
	blinking	module is possibly partially faulty	ICM installation problem	TRX(s) in fault	not used
switched off		alarm status: module NOK, must be removed and replaced	used	RM is in fault	used
switched off	blinking	module is being indicated	not used	not used	not used
blinking	 or switched off	wait for ICM connection	used on passive ICM	used	used
blinking	blinking	internal downloading	used on passive ICM	not used	used

Table 3-3 BTS18000 corporate LEDs behavior (RM, ICM, ABM)

3.2.2.4 Ethernet LEDs behavior

The TX (green) and LI (amber) Ethernet LEDs are on the Ethernet connector. See *Table 3-3* for color explanations.



LED Name	Color	Meaning
LI		Ethernet link, switched on when connection is established
TX		TX Ethernet, switched on during data transfer

Table 3-4 RM Ethernet LEDs behavior

3.2.2.5 TRX LEDs behavior

Table 3-5 describes the TRX LEDs behavior.

LED Name	Color	Meaning
TRX 0-1-2	Amber	<ul style="list-style-type: none"> - flashes during SPU cluster download - blinks until BSC connection, including Abis downloading - switched off when TRX is operational

Table 3-5 RM TRX 0-1-2 LEDs behavior

3.2.2.6 LEDs behavior at RM starting up

Table 3-6 describes the LEDs behavior at RM starting up.













	RM power up	RM start up	RM BISTs	RM soft start	RM soft init (1/2)	SPU load & start	RM soft init (2/2)	Connection to BCF/Abis downloading	Nominal operation
triangle corporate									
rectangle corporate					blinking 	blinking 	blinking 		
TRX 0-1-2	amber		amber			amber blinking		amber blinking	

Table 3-6 LEDs behavior at RM starting up

3.2.3 High Power Radio Module (HPRM)

The HPRM is a variant of the RM with only a two-TDMA capacity. This variant shares with the RM the following elements:

- the PSU,
- the LRM,
- the RM TX,
- the RM RX.

The BTS18000 with HPRM is only available in GSM900 frequency band.

The HPRM can operate on:

- one-sector basis (two carriers per sector, O2 mode),
- two-sector basis (one carrier per sector, S11 mode).

Maximum configurations for BTS18000 mono-cabinet with HPRM are S444, O12 and S66.

3.2.4 Interface Control Module (ICM)

3.2.4.1 Function

The ICM is only used in the BTS18000 base cabinet. It is not present in the extension cabinets. It is designed to manage the whole BTS18000 site in simplex configuration.

The ICM in simplex mode covers the functions related to a complete site including:

- support of drop-and-insert facilities for the PCM links with the BSC,
- reference clock for the air interface, synchronized on the Abis PCM interface, a synchronizing BTS or a GPS antenna,
- GSM_TIME calculations with possible network synchronization,
- switching of PCM slots,
- conversion of electrical signals, from external to internal PCM data formats,
- concentration of the data flow of the BTS,
- configuration and supervision of all the modules.

The ICM is composed of a single board with connections on the IBP and on the front panel.

3.2.4.2 Front panel

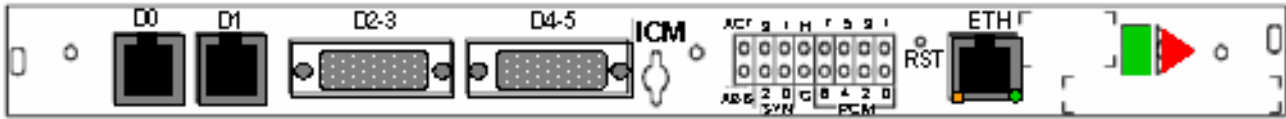

Figure 3-5 ICM front panel

3.2.4.3 LEDs behavior

For detailed information on the BTS18000 corporate LEDs behavior, refer to *Section 3.2.2.3. Table 3-7* gives detailed information on ICM LEDs behavior. All the LEDs are OFF when the ICM is un-powered. All the LEDs are amber during BISTs.

LED name	Color	Meaning
PCMX (x = 0 to 7)	<ul style="list-style-type: none"> ● Green ● Red ● Amber 	8 PCM status LEDs (one per PCM): <ul style="list-style-type: none"> - Green: the PCM is OK - Red: the PCM is in fault - Amber: the PCM is in test
G (GPS)	<ul style="list-style-type: none"> ● Green ● Red ● Amber 	1 GPS or external synchro status LED: <ul style="list-style-type: none"> - OFF: no external synchronization - Green: GPS synchronization - Red: bad external synchronization signal - Amber: master BTS synchronization
SYN (synchro)	<ul style="list-style-type: none"> ● Green 	Four LEDs for synchronizing source: one out of the 8 PCMs or external synchronization (in that case the 4 LEDs are ON) <ul style="list-style-type: none"> - see <i>Table 3-8</i> -
H (holdover)	<ul style="list-style-type: none"> ● Red 	One LED for synchro locked status: <ul style="list-style-type: none"> - ON on active ICM: un-locked or holdover indication - ON on passive ICM: un-locked indication - OFF: synchro is locked on external source
ACT (activity)	<ul style="list-style-type: none"> ● Green ● Red 	One LED for ICM Passive or Active Status: <ul style="list-style-type: none"> - Green: the ICM is active - OFF: the ICM is passive - Red on both ICMs: the simplex or duplex configuration cannot be determined, both ICMs are in faulty passive state
ABIS	<ul style="list-style-type: none"> ● Green 	Level-2 status with BSC: <ul style="list-style-type: none"> - ON: level-2 is OK - Blinking: downloading in progress - OFF: no Level-2 with the BSC

Table 3-7 ICM LEDs behavior

The behavior of the four LEDs for synchronization source is described in *Table 3-8*.

SYNCHRO SOURCE	0	1	2	3
PCM 0	●	switched off	switched off	switched off
PCM 1	switched off	●	switched off	switched off
PCM 2	●	●	switched off	switched off
PCM 3	switched off	switched off	●	switched off
PCM 4	●	switched off	●	switched off
PCM 5	switched off	●	●	switched off
PCM 6	●	●	●	switched off
PCM 7	switched off	switched off	switched off	●
external source (GPS, master BTS)	●	●	●	●
holdover	switched off	switched off	switched off	switched off

Table 3-8 ICM SYN LEDs behavior

3.2.4.4 LEDs behavior at active ICM starting up

The LEDs behavior, when the active ICM starts up, is as follows:

- 1 When the BTS18000 is turned on, H (holdover) and ACT (active) LEDs switch ON.
- 2 After the Built-in Self Test (BIST) sequence, the ICM searches for synchronizing with the PCM0 link.
- 3 When the clock source is found, H LED switches OFF and synchro source LEDs (SYN) switch ON (see *Table 3-8*).

Table 3-9 describes the LEDs behavior at active ICM starting up.

	ICM boot sequence	ICM BISTs	Abis connection	ICM downloading	Nominal operation
triangle corporate					
rectangle corporate					
ACT					
SYN					
G					
Abis				blinking	
PCMx					
H					

Table 3-9 LEDs behavior at active ICM starting up

3.2.4.5 LEDs behavior at passive ICM starting up

The passive ICM can be differentiated from the active one thanks to the ACT LED switched off. The behavior of the SYN and PCM LEDs is the same as for the active ICM.

Table 3-10 describes the LEDs behavior at passive ICM starting up.

	ICM boot sequence	ICM BISTs	Active ICM connection	Passive ICM downloading	Nominal operation
triangle corporate			or switched off	blinking	
rectangle corporate			blinking	blinking	
ACT					
SYN					
G					
Abis					
PCMx					
H					

Table 3-10 LEDs behavior at passive ICM starting up

3.2.4.6 Configuration of the ICM switches for commissioning

SW0-SW7 switches: one per Abis line

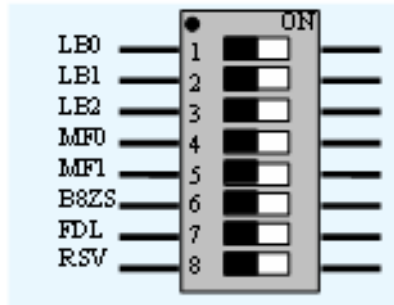

Figure 3-6 ICM Abis switch

The E1 or T1 mode selection is performed thanks to switch SW10 (see *Table 3-13*). Refer to *Table 3-11* and *Table 3-12* for detailed information on E1/T1 configurations of the ICM Abis switches.

MF1	MF0	Frame Format
OFF	OFF	12-frame multi-frame (Super-Frame)
OFF	ON	Extended Super-frame (ESF) with CRC6 check/generation
ON	OFF	Extended Super-frame (ESF) without CRC6 check/generation
ON	ON	Not used

LB2	LB1	LB0	Line Build-Out
OFF	OFF	OFF	length = 000..133ft (0.6dB - DSX-1) / 0.0dB (DS1)
OFF	OFF	ON	length = 133..266ft (1.2dB - DSX-1)
OFF	ON	OFF	length = 266..399ft (1.8dB - DSX-1)
OFF	ON	ON	length = 399..533ft (2.4dB - DSX-1)
ON	OFF	OFF	length = 533..655ft (3.0dB - DSX-1)
ON	OFF	ON	-7.5dB (DS1)
ON	ON	OFF	-15.0dB (DS1)
ON	ON	ON	-22.5dB (DS1)

B8ZS	Line code
OFF	AMI coding
ON	B8ZS coding

Table 3-11 ICM Abis switch - T1 configuration

FDL (Facility Data-Link) and RSV are not used. Their default value is OFF.

MF1	MF0	Frame Format
OFF	OFF	Single frame
OFF	ON	Multi-frame with CRC4 decoding
ON	OFF	Multi-frame without any CRC4 decoding
ON	ON	Automatic multi-frame with CRC4 decoding

LB2	LB1	LB0	Line Build-Out is NOT used
OFF	OFF	OFF	Default value

B8ZS	Line code
OFF	HDB3 coding
ON	AMI coding (provision)

Table 3-12 ICM Abis switch - E1 configuration

FDL (Facility Data-Link) and RSV are not used. Their default value is OFF.

SW10 switch

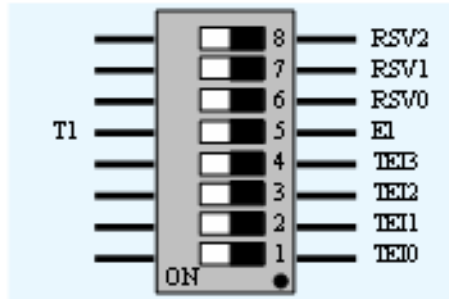

Figure 3-7 ICM SW10 switch

E1/T1	RSV0	Frame Format
OFF	OFF	E1 mode (120 ohms)
OFF	ON	E1 mode with 75 ohms adapter
ON	-	T1 mode (100 ohms)

TEI(3)	TEI(2)	TEI(1)	TEI(0)	Site TEI coding
OFF	OFF	OFF	OFF	0
OFF	OFF	OFF	ON	1
OFF	OFF	ON	OFF	2
OFF	OFF	ON	ON	3
OFF	ON	OFF	OFF	4
OFF	ON	OFF	ON	5
OFF	ON	ON	OFF	6
OFF	ON	ON	ON	7
ON	OFF	OFF	OFF	8
ON	OFF	OFF	ON	9

Table 3-13 ICM SW10 switch configuration

An ICM board cannot start if its TEI value is out of the range given in *Table 3-13*. Factory setting is TEI equal to zero. RSV(0-2) are unused (default value is OFF).

SW11 switch

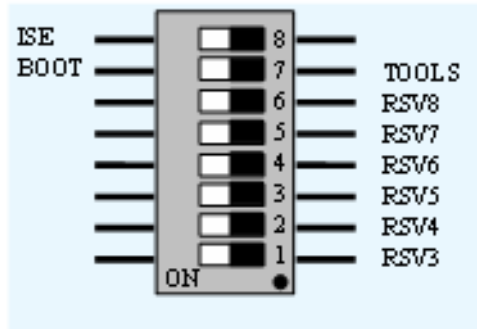

Figure 3-8 ICM SW11 switch

ISE	ICM for New-SEB mode
OFF	ICM in nominal mode
ON	ICM in New-SEB mode if confirmation bit is set in FPGA

BOOT/TOOLS	Processor booting mode
OFF	Require emulator probe connected
ON	Booting in Flash memory (nominal mode)

Table 3-14 ICM SW11 switch configuration

RSV(3-8) are unused (default value is OFF). Passive and active ICM must have the same switches configuration. Otherwise, both ICM are in the "passive partially faulty" state: the corporate green LED is ON and the red one is blinking.

3.2.5 Interface Module (IFM)

The IFM is only used in the BTS18000 base cabinet. It is not present in the extension cabinets. Its main function is to provide connectivity and secondary protection on the PCM links.

It provides the following access for the ICM:

- E1 (120 ohms) or T1 (100 ohms) connectivity on the Abis link with secondary protection and filters (four PCM per IFM),
- connectivity for an external synchronization source (synchronizing BTS or GPS antenna),
- connectivity for Abis extension and redundant ICM options.

The IFM is a passive board.

3.2.6 Spare Module (SPM)

The SPM is reserved for future use in the BTS18000 base cabinet only. It is not present in the extension cabinets. The SPM is designed to add extra features to the ICM without replacing the ICM hardware.

3.2.7 Alarms and Bridge Module (ABM)

One ABM is used in each BTS18000 digital rack. Therefore, a BTS18000 cabinet contains two ABMs (even and odd).

The ABM is composed of a single board with connections on the DBP and on the front panel.

3.2.7.1 Alarm collector function

The ABM alarm collector function performs the following operations under the ICM control:

- Detection of cabinet alarms:
 - door status,
 - outdoor cabinet User Rack and ADU.
- Presence detection of the digital rack, combiner rack and other cabinet modules:
 - digital rack modules: IFM, ICM, SPM and the three RMs,
 - RF combiners: DDM, TX filter (TXF), DDM (H2) and TXF (H2),
 - cabinet modules: indoor SICS, outdoor ECU and UCPS.

- Inventory of the digital rack, combiner rack and other cabinet modules:
 - IFM, ICM, SPM and the three RMs, via the I2C bus,
 - DDM, TXF, DDM (H2) and TXF (H2), via the pseudo I2C over RS422,
 - indoor SICS and outdoor ECU,
 - UCPS modules, through a dedicated protocol over RS422.
- Alarm polling of the radio coupling modules, through the pseudo I2C bus over RS422:
 - Low Noise Amplifier (LNA) over-current detection in the DDMs,
 - VSWR alarms and associated setting of thresholds in the DDMs and TX filters with the VSWR option.
- Alarm polling of the cooling system modules, through the pseudo I2C bus over RS422:
 - indoor SICS blowers, filter, power and control board status,
 - outdoor ECU blowers, filter, damper, heater, power and control board status.
- Alarm polling of the outdoor cabinet UCPS:
 - AC monitoring,
 - DC monitoring,
 - breakers status,
 - battery status.
- Software management of the outdoor cabinet UCPS, through a dedicated protocol over RS422:
 - updating of the UCPS software release,
 - setting up of certain parameters inside the UCPS in order to fit its configuration to the BTS18000 cabinet and battery type,
 - controlling the UCPS.
- Optional external alarm detection (up to eight customer alarms per ABM).
- Remote control drive (up to two remote controls per ABM).

3.2.7.2 Bridge function

The ABM assures bridge functions between several interfaces:

- On one side, it manages interface with ICM (one front panel D link or two in case of ICM redundancy),
- On the other side, the bridge manages one internal E link for ABM alarm function and three E links to the RM modules.

3.2.7.3 Front panel

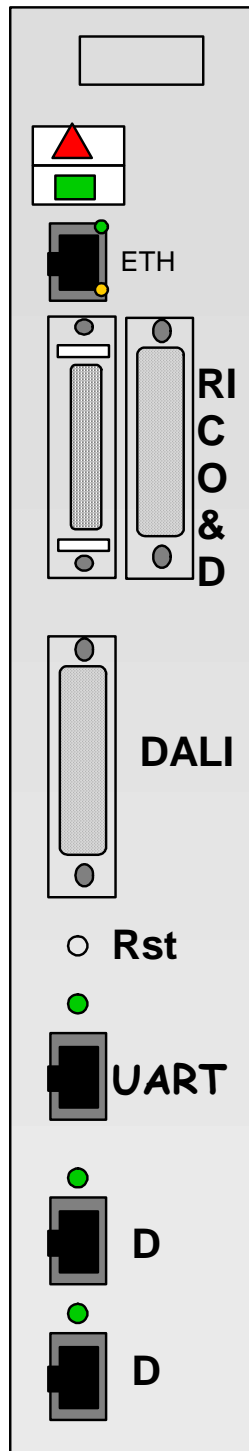

Figure 3-9 ABM front panel

3.2.7.4 ABM LEDs behavior

For detailed information on the BTS18000 corporate LEDs behavior, refer to *section 3.2.2.3*.

Table 3-15 describes the ABM LEDs behavior.



LED Name	Color	Meaning
D		2 LEDs for D activity ON: when the connection to active ICM through the D link related to the LED is correctly established Only one of the 2 D LEDs can be ON
UART		ON: UART activity (reserved for future use)

Table 3-15 ABM LEDs behavior

3.2.7.5 LEDs behavior at ABM starting up

Table 3-16 describes the LEDs behavior at ABM starting up.













	ABM boot sequence	ABM BIST	Active ICM connection	ABM downloading	Nominal operation
triangle corporate			 or switched off	 blinking	
rectangle corporate			 blinking	 blinking	
D					

Table 3-16 LEDs behavior at ABM starting up

Note: External alarms do not impact the ABM corporate LEDs management (these LEDs only indicate ABM board alarms).

3.2.8 Dual Duplexer Module (DDM) and Transmit Filter (TXF)

The operator can use different types of couplers to couple the PAs to the antennas and to combine the RX and TX paths:

- duplexers,
- transmit filters,
- hybrid combiners.

These couplers can be found in the following BTS18000 modules:

- DDM or DDM with optional H2 coupling, both including an optional VSWR meter,
- TXF or TXF with optional H2 coupling, both including an optional VSWR meter.

3.2.8.1 Dual Duplexer Module (DDM)

The DDM allows to share TX and RX signals on a same antenna. The DDM is aimed at providing:

- TX filtering (noise suppression),
- RX filtering (noise suppression),
- TX to RX isolation,
- front end low noise amplification for the receive chain.

Front panel

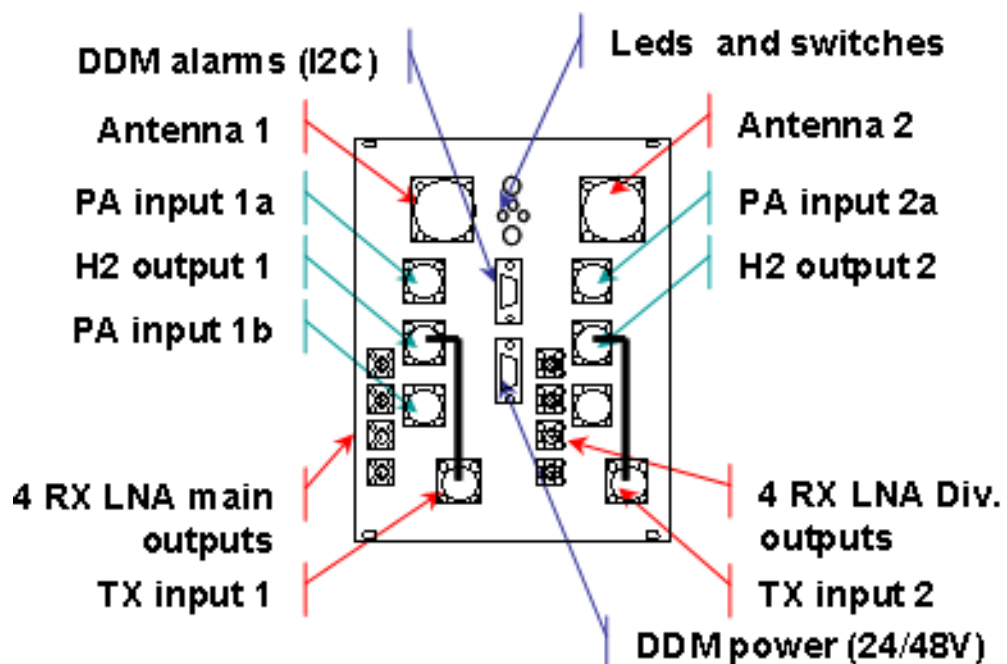
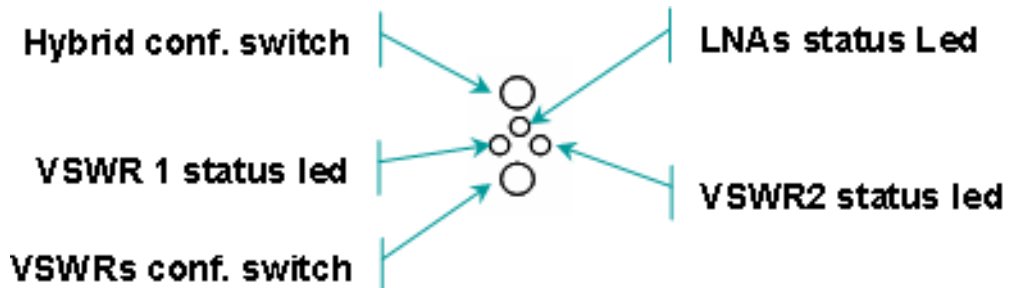

Figure 3-10 DDM front panel (with H2 coupling option)

DDM LEDs description**Figure 3-11 DDM LEDs and switches details****DDM LEDs behavior**

Three LEDs are located on the DDM front panel in order to monitor DDM internal alarm:

- one LED is dedicated to LNAs high/low consumption alarm,
- two LEDs are dedicated to VSWR meter:
 - one for antenna 1 port,
 - one for antenna 2 port.

Table 3-17 describes the DDM LEDs behavior.

LED Name	Color	Meaning
LNA	●	ON when LNA is enabled
VSWR1	● ●	Red: Port 1 VSWR alarm level 3 Amber: Port 1 VSWR alarm level 2 OFF: no alarm or level 1
VSWR2	● ●	Red: Port 2 VSWR alarm level 3 Amber: Port 2 VSWR alarm level 2 OFF: no alarm or level 1

Table 3-17 DDM LEDs behavior

Configuration of the DDM switches for commissioning

Two four-position rotate switches are located on the DDM front panel (see *Figure 3-11*).

These switches must be positioned on site:

- The hybrid configuration switch is used to inform the system about the use of the two 2-way hybrid (by-passed or not).

Table 3-18 gives the switch position meaning.

Hybrid configuration switch	Switch position
DDM with two hybrids	0
DDM with hybrid 1 connected	1
DDM with hybrid 2 connected	2
DDM without hybrid	3

Table 3-18 **DDM switches configuration**

- The VSWR switch allows modifying, on site, the VSWR meter thresholds on both antenna ports. The three first positions (positions 0, 1 and 2) are used to offset VSWR thresholds of respectively 0, 2 or 4 dB.

The fourth position (test position) checks that the three LEDs operate correctly.

3.2.8.2 Transmit Filter (TXF)

The TXF is used, as a complement of the DDM, each time extra transmit capacity is required without need of receive capacity. It allows direct connection from the RM PA output to the antenna.

The TXF only filters the signal transmitted from the PA to the antenna and does not provide the reception path.

Front panel

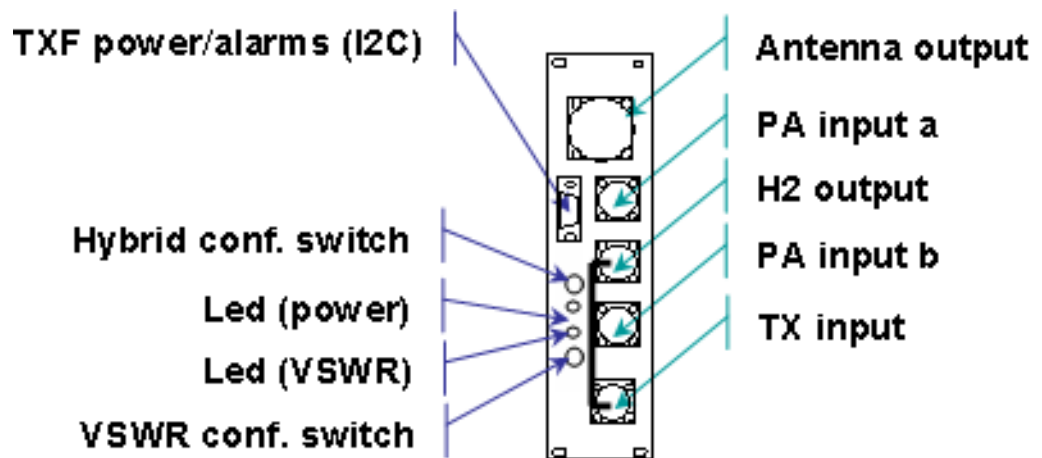

Figure 3-12 TXF front panel (with H2 coupling option)

TXF LEDs behavior

Two LEDs are located on the TXF font panel in order to monitor TXF alarm:

- one LED is dedicated to DC power status,
- one LED is dedicated to VSWR meter.

Table 3-19 describes the TXF LEDs behavior.

LED Name	Color	Meaning
Power	●	ON when TX filter is powered on
VSWR	● ●	Red: VSWR alarm level 3 Amber: VSWR alarm level 2 OFF: no alarm or level 1

Table 3-19 TXF LEDs behavior

Configuration of the TXF switches for commissioning

Two switches are located on the TXF front panel (see *Figure 3-12*). These switches must be positioned on site:

- The hybrid configuration two-position switch is used to inform the system about the use of the hybrid (by-passed or not).

Table 3-20 gives the switch position meaning.

Hybrid configuration switch	Switch position
TXF with hybrid	0
TXF without hybrid	1

Table 3-20 TXF switches configuration

- The VSWR four-position switch allows modifying, on site, the VSWR meter thresholds on both antenna ports. The three first positions (positions 0, 1 and 2) are used to offset VSWR thresholds of respectively 0, 2 or 4 dB.

The fourth position (test position) checks that the two LEDs operate correctly.

PAGE INTENTIONALLY LEFT BLANK

8 MCPA BTS18000 CONFIGURATIONS

8.1 MCPA BTS18000 overview

The Nortel Networks solution for a high capacity, high output power GSM BTS site is composed of:

- up to two dedicated BTS18000 cabinets, named MCPA BTS18000 cabinets.
This MCPA version of BTS18000 cabinet is an adaptation of standard outdoor version with a capacity of up to 27 TRXs per cabinet. This adaptation is factory-performed.
- one ancillary MCPA cabinet.

8.2 MCPA BTS18000 hardware

8.2.1 Description of the MCPA BTS18000 outdoor cabinet

The MCPA BTS18000 cabinet is the BTS18000 outdoor cabinet equipped to drive a MCPA cabinet. It includes the following elements:

- modified outdoor enclosure,
- AC/DC power supply: Univity Compact Power System (UCPS),
- Environmental Control Unit (ECU),
- User Rack space and its associated User ICO,
- back-planes and ICO: Interface Back-Plane (IBP), Digital Back-plane (DBP), Radio InterConnect board (RICO),
- up to two Interface Modules (IFM),
- one Interface Control Module (ICM) or two ICMs (in an active/passive configuration),
- up to two SPare Modules (SPM),
- up to three Alarm and Bridge Modules (ABM), including:
 - the standard even and odd ABMs,
 - a new ABM called neutral,
- up to nine MCPA Radio Modules (MRM),
- up to three low power 3:1 TX combiners,
- up to three double 1:3 RX splitters.

Figure 8-1 presents the MCPA BTS18000 outdoor cabinet layout and situates the modules in a fully equipped cabinet.

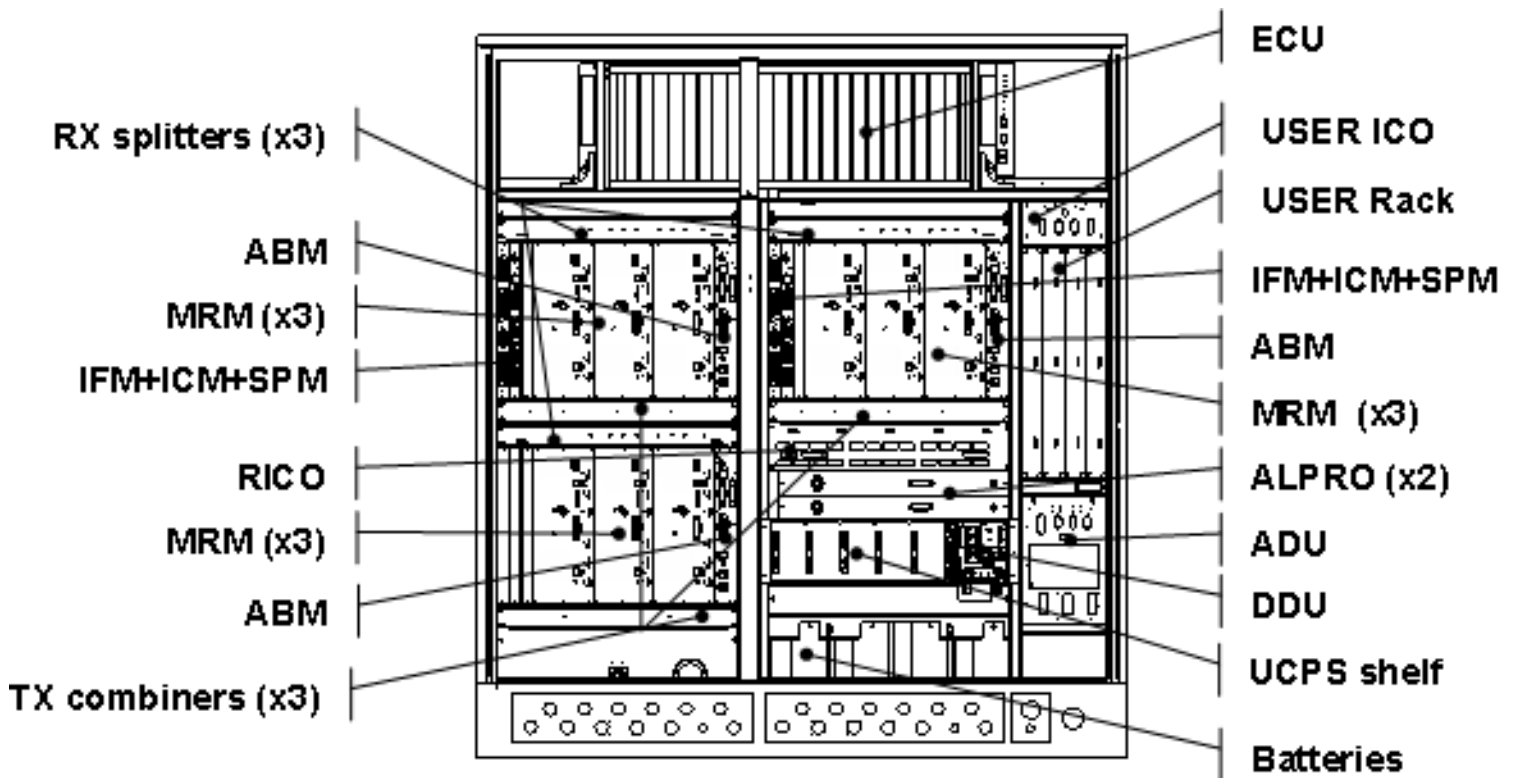

Figure 8-1 MCPA BTS18000 outdoor equipped cabinet with door opened (front view)

8.2.2 Description of the MCPA BTS18000 specific modules

8.2.2.1 MCPA Radio Module (MRM)

The MRM is a depopulated version of the RM, only used in O3 mode. The MRM shares with the RM the following components:

- LRM,
- RM TX,
- RM RX,
- PSU.

In MRM, the three PA boards are replaced by a unique board called TX booster. The TX booster main functions are:

- Amplification.

The TX booster provides extra amplification to the RM TX output (one per TX chain).

- Power regulation.

The TX booster provides an output power detector on each RF chain, in order to maintain constant the output power of each chain, with the same Automatic Level Control (ALC) loops as the standard RM.

- RF combining.

The TX booster incorporates a transmit RF combiner 3:1, in order to deliver multi-carrier signals on a unique TX output. The MRM output power is 4dBm +/-0.5dB per carrier.

Compared to the RM, power/digital and RF RX interfaces remain unchanged.

Figure 8-2 presents the MRM front panel.

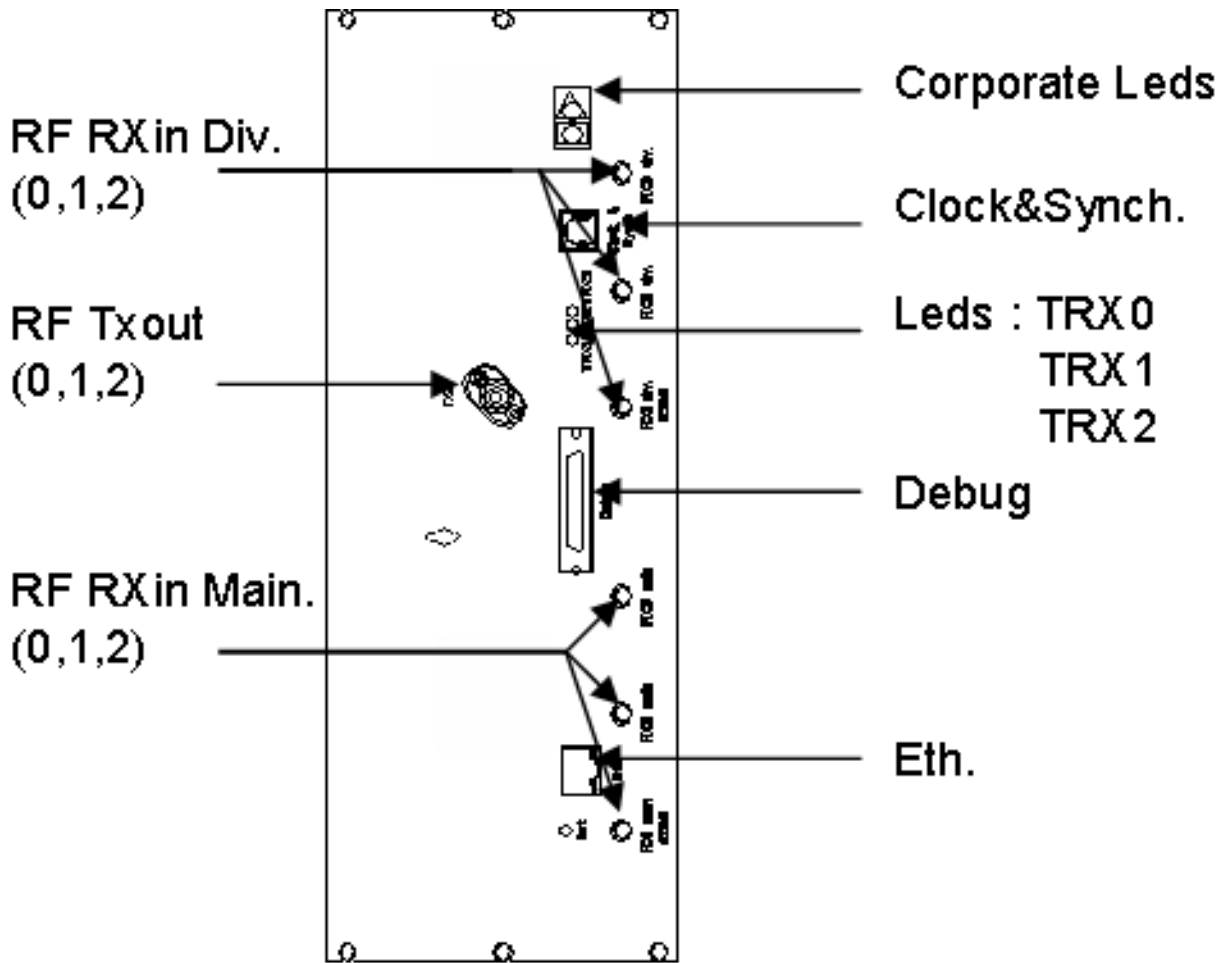

Figure 8-2 MRM front panel

As shown on *Figure 8-3*, an upper triangle-shaped red LED and a lower rectangle-shaped green LED are used to indicate the status for the MRM, as well as for the ICM and ABM modules. See *Table 8-1* for detailed status information.

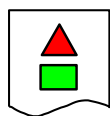

Figure 8-3 BTS18000 corporate LEDs for MRM, ICM and ABM







Green LED	Red LED	Module status	ICM	MRM	ABM
switched off	switched off	un-powered or not inserted (default hardware value)	used	used	used
		starting, BISTs in progress	used	used	used
	switched off	module OK (should not be removed)	used	used	used
	blinking	module is possibly partially faulty	ICM installation problem	TRX(s) in fault	not used
switched off		alarm status: module NOK, must be removed and replaced	used	MRM is in fault	used
switched off	blinking	module is being indicated	not used	not used	not used
blinking	 or switched off	wait for ICM connection	used on passive ICM	used	used
blinking	blinking	internal downloading	used on passive ICM	not used	used

Table 8-1 BTS18000 corporate LEDs behavior (MRM, ICM, ABM)

8.2.2.2 3:1 TX combiner

The 3:1 TX combiner allows to combine up to nine transmit signals from the three MRM TX outputs to one MCPA input. This combiner is a passive module.

The RF interfaces are:

- for the TX output port, one QN 50 ohms connector,
- for the TX inputs ports, three QN 50 ohms connectors.

8.2.2.3 Double 1:3 RX splitter

The double 1:3 splitter allows to split two receive signals (main and diversity) from the MCPA cabinet Duplexer Low Noise Amplifier (DLNA). This splitter can feed three MRMs RX inputs. This splitter is a passive module.

The RF interfaces are:

- for the RX input ports, two QMA 50 ohms connectors,
- for the RX outputs ports, six QMA 50 ohms connectors.

8.3 MCPA cabinet

The MCPA cabinet includes up to:

- three 2-way MCPA racks,
- six DLNAs with VSWR.

The MCPA cabinet is responsible for:

- amplifying the transmit composite signals coming from the MCPA BTS18000 cabinet, in the GSM1900 transmit band (1930-1990 MHz).
- supplying the MCPA BTS18000 cabinet with the receive composite signals, in the GSM1900 receive band (1850-1910 MHz).
- assuring antenna RF combining:
 - dual antenna connection for transmit and receive main and diversity,
 - three-sector operation.

In addition, the MCPA cabinet is independent from the MCPA BTS18000 cabinet in terms of power supply and cooling system.

8.3.1 MCPA rack overview

The association of two MCPA basic modules constitutes a 2-way rack. Each MCPA rack is always dedicated to only one sector.

All the carriers need to be combined to constitute a composite multi-carrier signal that feed one MCPA rack input. The MCPA amplifies this composite signal.

Duplexer coupling is used for the antenna access. The duplexer manages:

- one transmit path, that can be feed only by one MCPA rack output,
- up to two receive paths.

A LNA is integrated close to the duplexer, in order to amplify reception chains to the MRM.

The MCPA rack main features are:

- frequency of operation: 1930-1990 MHz,
- instantaneous bandwidth of operation: 20 MHz,
- nominal gain: 51.5 dB,
- gain variations (all conditions): +/- 0.7 dB,
- maximum composite output power: 218W (2 ways).

8.3.2 DLNA module overview

The DLNA is design as a Field Replaceable Unit (FRU). The DLNA provides:

- duplexed antenna connection for the whole system in transmit and receive GSM1900 band (TX 1930-1990 MHz, RX 1850-1910 MHz),
- transmit filtering and receive filtering,
- proper isolation between RX and TX frequency band,
- front end low noise amplification for the receive path.

The DLNA provides one RX path with two outputs. It also provides one transmit input. One DLNA is used for main receive path and another one is used for diversity receive path.

All MCPA BTS18000 configurations require six DLNAs. Each DLNA is connected to one I2C bus. The DLNAs are supervised by the even and odd ABMs of the MCPA BTS18000 base cabinet. Even if present, the MCPA BTS18000 extension cabinet does not manage any DLNA.

The DLNAs are powered by the MCPA cabinet energy system.

8.3.2.1 RF interfaces

The RF interfaces are:

- one RF antenna connector (50 Ohms 1850-1990 MHz),
- one TX input (50 Ohms 1930-1990 MHz),
- two RX outputs (50 Ohms 1850-1910 MHz).

8.3.2.2 Digital interface

The DLNA interfaces, for the digital part, with the ABM module of the MCPA BTS18000 cabinet. The DLNA provides the ABM (even or odd) with the following information:

- module presence detection,
- inventory data,
- VSWR alarms level 1, 2 and 3,
- LNA high/low current consumption alarm.

The connection is performed through the RICO interconnect board, via I2C bus.

8.3.3 DLNA RF features

The DLNA main RF features are:

- frequency of operation: TX 1930-1990MHz, RX 1850-1910MHz,
- transmit loss: 0.7 dB typ. 1.2 dB maximum,
- receive path gain: 44 dB,
- receive path gain variations: +/- 1 dB all conditions,
- receive path noise figure: 2 dB typ. 2.5 dB maximum,
- receive path input compression point: -16 dBm minimum,
- receive path input IP3: -8 dBm minimum,
- isolation transmit/receive: greater than 105 dB.

8.3.4 VSWR meter

The DLNA is equipped with a VSWR meter in order to control matching of the antenna path. This VSWR meter is used to supervise the connection between DLNA antenna connector and antenna.

The VSWR meter measures the voltage standing wave ratio and compares it to three pre-defined thresholds. These thresholds correspond to three levels of alarm that are reported to the MCPA BTS18000 cabinet through the I2C interface (see *Table 8-2*).

Alarm	0dB	2dB	4dB	I2C address	Priority
level 3	6.0dB ± 2.0dB	8.0dB ± 2.25dB	10.0dB ± 2.5dB	111	critical
level 2	9.5dB ± 2.5dB	11.5dB ± 3.0dB	13.5dB ± 3.5dB	011	minor
level 1	12.0dB ± 3.0dB	14.0dB ± 3.5dB	16.0dB ± 4.0dB	001	minor

Table 8-2 DLNA alarms levels and priority

8.3.5 MCPA cabinet alarm monitoring

The MCPA BTS18000 is in charge of MCPA cabinet alarm monitoring. Each MCPA BTS18000 cabinet contains up to three ABMs:

- even ABM,
- odd ABM,
- neutral ABM.

8.3.5.1 MCPA cabinet alarms

Those alarms are recovered by the neutral ABM of the MCPA BTS18000 base cabinet, through DALI links.

8.3.5.2 MCPA alarms

Those alarms are recovered:

- by the neutral ABM of the MCPA BTS18000 base cabinet, through DALI links, for up to three MCPA racks,
- by the neutral ABM of the MCPA BTS18000 extension cabinet, through DALI links, for the three additional MCPA racks.

8.3.5.3 DLNA alarms

Those alarms, including VSWR alarms (level 1, 2 and 3), are recovered:

- by the even ABM of the MCPA BTS18000 base cabinet, through I2C links, for DLNA main,
- by the odd ABM of the MCPA BTS18000 base cabinet, through I2C links, for DLNA diversity.

Figure 8-4 and *Figure 8-5* illustrate the digital alarms/inventory connections between the MCPA BTS18000 and the MCPA cabinet.

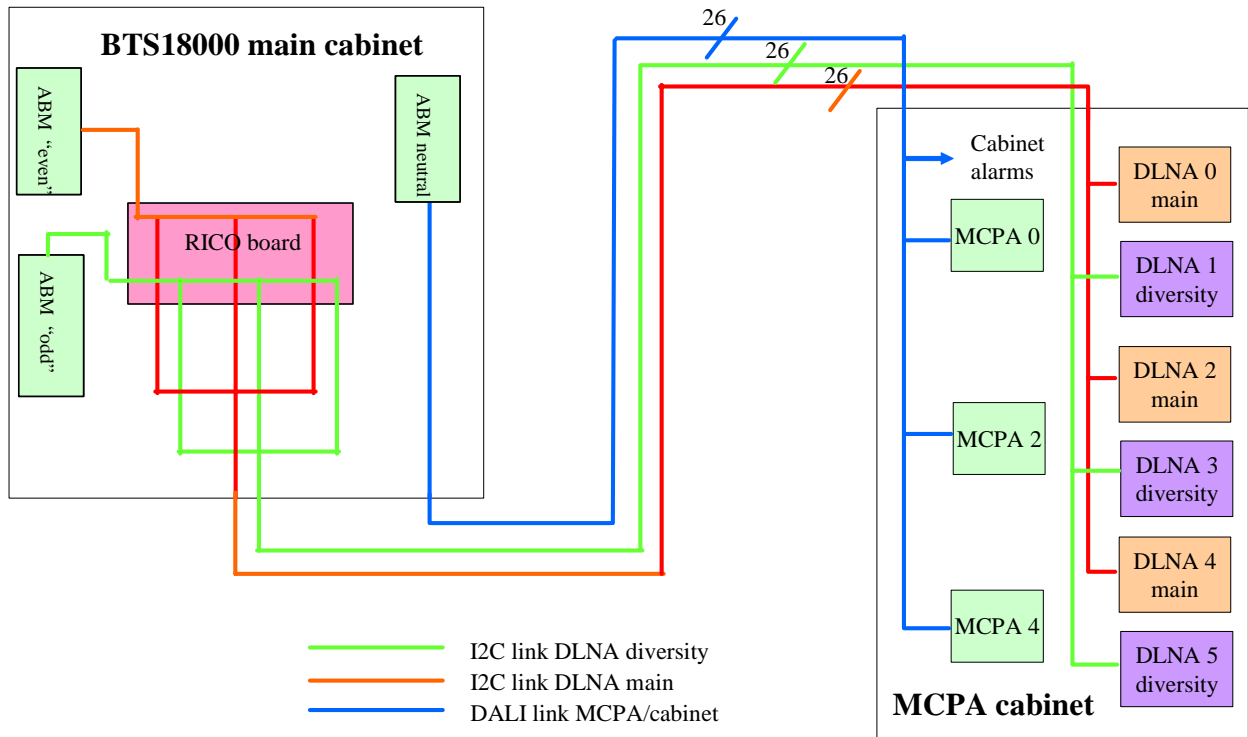

Figure 8-4 MCPA BTS18000 / MCPA cabinet digital links overview (configuration with three MCPA racks)

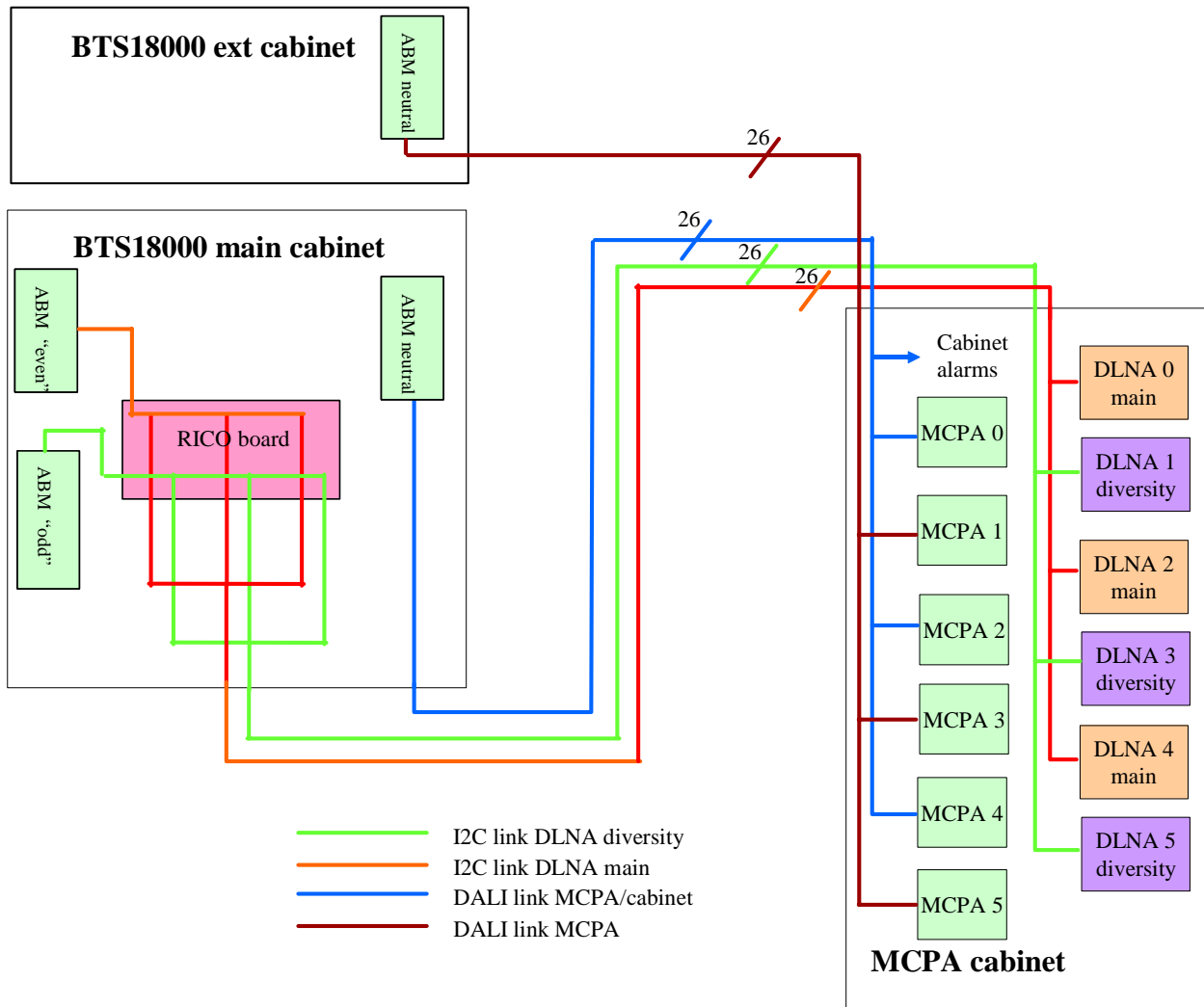

Figure 8-5 MCPA BTS18000 / MCPA cabinet digital links overview (configuration with six MCPA racks)

Note: In addition, as in standard configurations, the even ABM of each cabinet is in charge of cooling and power system and common alarms of MCPA BTS18000 cabinet.

The RICO board of each MCPA BTS18000 cabinet is powered (3.3V) by the neutral ABM of each cabinet.

PAGE INTENTIONALLY LEFT BLANK