



ECLIPSE™

INSTALLATION MANUAL

5.8 GHz Unlicensed Band

Rev.001



Eclipse Microwave Radio Installation Manual

For FCC 5.8 GHz Unlicensed Band

August 2010

Eclipse Installation Manual

This manual is specific to Eclipse with IRU 600 for all-indoor operation on the FCC 5.8 GHz unlicensed band.

Compliance and Notices

260-668066-003 Rev 001 August 2010

Copyright © 2010 by Aviat Networks, Inc.

All rights reserved. No part of this publication may be reproduced, transmitted, transcribed, stored in a retrieval system, or translated into any language or computer language, in any form or by any means, electronic, magnetic, optical, chemical, manual or otherwise, without the prior written permission of Aviat Networks Inc. To request permission, contact techpubs@aviatnet.com.

Warranty

Aviat Networks makes no representation or warranties with respect to the contents hereof and specifically disclaims any implied warranties or merchantability or fitness for any particular purpose. Further, Aviat Networks reserves the right to revise this publication and to make changes from time to time in the content hereof without obligation of Aviat Networks to notify any person of such revision or changes.

Safety Recommendations

The following safety recommendations must be considered to avoid injuries to persons and/or damage to the equipment:

Installation and Service Personnel: Installation and service must be carried out by authorized personnel who have the technical training and experience necessary to be aware of any hazardous operations during installation and service, and of measures to avoid any danger to themselves, to any other personnel, and to the equipment.

Access to the Equipment: Access to the equipment in use must be restricted to service personnel only.

Safety Norms: Recommended safety norms are detailed in the Health and Safety sections of this manual. Local safety regulations must be used if mandatory. Safety instructions in this document should be used in addition to the local safety regulations. In the case of conflict between safety instructions stated in this manual and those indicated in local regulations, mandatory local norms will prevail. Should local regulations not be mandatory, then the safety norms in Chapter 2 will prevail.

Service Personnel Skill: Service personnel must have received adequate technical training on telecommunications and in particular on the equipment this manual refers to.

Trademarks

All trademarks are the property of their respective owners.

Open Source Software

The software included in this product contains copyrighted software that is licensed under the GPL. A copy of that license and the complete corresponding source code is included on the CD that is shipped with the product. You may also obtain the complete corresponding source code from us for a period of three years after our last shipment of this product, by contacting us at softwarecompliance@aviatnet.com.

Product Compliance Notices

Eclipse has been tested for and meets EMC Directive 2004/108/EC. The equipment was tested using screened cable; if any other type of cable is used, it may violate compliance.

Eclipse is a Class A product. In a domestic environment this product may cause radio interference in which case the user may be required to take adequate measures. This equipment is intended to be used exclusively in telecommunications centers.

WARNING

Making adjustments and/or modifications to this equipment that are not in accordance with the provisions of this instruction manual or other supplementary documentation may result in personal injury or damage to the equipment, and may void the equipment warranty.

FCC Notices

1. Eclipse with IRU600, 5.8 GHz, must be professionally installed and maintained.
2. This equipment has been tested and found to comply with the limits for a Class A digital device, pursuant to Part 15 of the FCC rules. These limits are designed to provide reasonable protection against harmful interference when the equipment is operated in a commercial environment. This equipment generates, uses and can radiate radio frequency energy and, if not installed and used in accordance with the instruction manual, may cause harmful interference to radio communications. Operation of this equipment in a residential environment is likely to cause harmful interference in which case the user will be required to correct the interference at his own expense.
3. Eclipse with IRU600, 5.8 GHz, is compliant with FCC CFR47, Part 15.247.
4. To ensure compliance with the FCC RF exposure requirements, a minimum distance of 20 meters must be maintained between the antenna and any persons whilst the unit is operational. This calculation is based on the maximum conducted power and maximum antenna gain.
5. Eclipse with IRU600, 5.8 GHz, has been tested and certified for use with a parabolic antenna with a maximum gain of 46.8 dBi.
6. The filters provided with this product allow for transmission only in the frequency range 5725 - 5850MHz to ensure compliance with Part 15.247.
7. According to the conducted power limit in FCC CFR 47, Part 15.247, the power for this device has been limited to 1W (30dBm) at the antenna port.

International Use of 5.8GHz

This system does not employ DFS and, as such the equipment cannot be deployed within Europe or any country where DFS is a regulatory requirement for protection of radars.

NEBS Compliance

The Eclipse Node comprising the INU and associated IRU 600 complies with the relevant NEBS requirements under GR-1089-CORE and GR-63-CORE. Such compliance requires installation of the Fan Air Filter option in the INUs, and adherence to the health and safety and equipment installation practices described herein.

WEEE Directive

In accordance with the WEEE Directive (2002/96/EC), Eclipse is marked with the following symbol:



This symbol indicates that this equipment should be collected separately for the purposes of recovery and/or recycling. For information about collection and recycling of Aviat Networks equipment please contact your local Aviat Networks sales office. If you purchased your product via a distributor please contact the distributor for information regarding collection and recovery/recycling.

More information on the WEEE Directive is available at our website: www.aviatnetworks.com/products/compliance/weee/.

(WEEE is the acronym is for Waste Electrical and Electronic Equipment)

RoHS Directive

The RoHS (Restriction of Hazardous Substances) Directive (2002/95/EC) was implemented on 1 July, 2006. Eclipse meets the requirements of this directive, as at the implementation date.

Date of Manufacture

Eclipse date of manufacture information is controlled by serial number. Please contact the Aviat Networks helpdesk for information regarding serial number format and date of manufacture.

Contact Information

Sales and Sales Support:

For sales information, contact the Aviat Networks headquarters, or find your regional sales office at <http://www.aviatnetworks.com/contact-us/sales/>.

Corporate Headquarters North Carolina, USA

Aviat Networks, Inc.

5200 Great American Parkway

Santa Clara, California 95054

U. S. A.

Phone: + 1 408 567 7000

Fax: + 1 408 567 7001

Toll Free for Sales Inquiries:

+ 1 888-478-9669

Customer Service:

For customer service, contact the Technical Help Desk listed below.

Americas Technical Help Desk

Aviat Networks

5200 Great American Parkway

Santa Clara, California 95054

U. S. A.

Phone: +1 210 561 7400

Toll-free in US:

+1 800 227 8332

Fax: +1 408 944 1683

tac.am@aviatnet.com

Or you can contact your local Aviat Networks office. Contact information is available on our website at: <http://www.aviatnetworks.com/services/customer-support/technical-assistance/>.

Contents

Eclipse Installation Manual	i-ii
Compliance and Notices	i-ii

CHAPTER 1, ABOUT ECLIPSE

About the Eclipse Documentation	1-x
Documentation Conventions and Terminology	1-x

CHAPTER 2, HEALTH AND SAFETY

General Health and Safety	2-1
Operator Health and Safety	2-2
General Hazards.....	2-3
RF Exposure	2-5
Routine Inspection and Maintenance	2-6
Routine Inspections	2-6
Trend Analysis	2-6
Fault Analysis.....	2-7
Training	2-7
Spares	2-7

CHAPTER 3, SYSTEM OVERVIEW

Eclipse Indoor Units	3-2
INU	3-2
INUe	3-3
Plug-in Cards.....	3-3
Plug-in Cards Overview	3-4
Eclipse IRU 600	3-9
Platform Layout.....	3-10
Protection Options.....	3-12
Link/Path Protection	3-12
Interface Protection.....	3-12
Network/Data Protection	3-12
Ring and Mesh Networks.....	3-13
Link Aggregation 2+0 Protection	3-13
Super PDH.....	3-13
Platform Protection.....	3-13
Bus Protection.....	3-13
Power Supply Protection	3-14
Eclipse Licensing	3-14
Configuration and Management.....	3-15
Eclipse Antennas.....	3-15
Eclipse Power Supply	3-16

CHAPTER 4, INTRODUCTION TO ECLIPSE INSTALLATION

Before Going On Site	4-1
Installation Tools and Materials	4-1
Unpacking the Eclipse Equipment.....	4-2

CHAPTER 5, INSTALLING THE IRU 600

IRU 600 Installation Procedure	5-1
Ventilation Requirement.....	5-2
Grounding	5-2
Safety Requirements for Equipment Grounding	5-3
Waveguide Grounding.....	5-3
NEBS Compliance	5-3
Connect Waveguide(s) to Antenna Ports(s).....	5-4
Power Supply.....	5-4

CHAPTER 6, INSTALLING THE INU AND INUE

INU/INUE Description.....	6-1
INU Front Panel Layout	6-1
INU Power Supply	6-2
Power Consumption and INU Load Maximums	6-3
PCC +24 Vdc Operation.....	6-4
Power Cables.....	6-5
Fuses.....	6-6
FAN Air Filter Option.....	6-6
Fan Air Filter Installation	6-6
Power Line Filter Option.....	6-7
INU/INUE Installation Requirements.....	6-8
Plug-in Installation Requirements	6-10
Installing an INU.....	6-13

Chapter 1. About Eclipse

Welcome to the Eclipse User Manual.

This introduction describes:

- [What Is Eclipse?](#)
- [What You Need To Know to Use Eclipse](#)
- [About the Eclipse Documentation](#)
- [Documentation Conventions and Terminology](#)

What Is Eclipse?

Eclipse supports multiple point-to-point radios for PDH, SDH and/or Ethernet on a single rack-mounted platform, to form a complete network node for star or ring configurations on the 5.8 GHz unlicensed frequency band.

For an introduction to the Eclipse system, see the [System Overview](#).

What You Need To Know to Use Eclipse

To install Eclipse, we recommend you have the following knowledge and skills:

- A basic understanding of the principles of microwave transmission.
- Installation and maintenance experience on PDH and SDH digital microwave radio systems.
- Familiarity with Ethernet and/or SDH multiplexing where these traffic options are to be employed on Eclipse.

Familiarity with the operation of a PC using the Windows operating system.



Follow health and safety procedures at all times! See [Health and Safety](#) for complete details.

About the Eclipse Documentation

This Installation documentation provides information on installing an Eclipse Microwave Radio system comprising the INU/INUe and IRU 600 RFU.

Intended Audience

This information is for use by trained technicians or engineers. It does not provide information or instruction on basic technical procedures. Aviat Networks recommends you read the relevant sections of this manual thoroughly before beginning any installation procedures on Eclipse.

Documentation Conventions and Terminology

Caution, Warning and Note Cues

The following cues are used to characterize particular types of associated supporting information.



*A **caution** item identifies important information pertaining to actions that may cause damage to equipment, loss of data, or corruption of files.*



*A **warning** item identifies a serious physical danger or major possible problem.*



*A **note** item identifies additional information about a procedure or function.*

Chapter 2. Health and Safety

This section includes the following health and safety information:

- [General Health and Safety](#)
- [Operator Health and Safety](#)
- [General Hazards](#)
- [RF Exposure](#)
- [Routine Inspection and Maintenance](#)

All personnel must comply with the relevant health and safety practices when working on or around the Eclipse radio equipment.

The Eclipse system has been designed to meet relevant US and European health and safety standards as outlined in IEC Publication 60950-1.

Eclipse is a Class A product. It is intended to be used exclusively in telecommunications centers.

Local safety regulations must be used if mandatory. Safety instructions in this Volume should be used in addition to the local safety regulations. In the case of conflict between safety instructions stated herein and those indicated in local regulations, mandatory local norms will prevail. Should not local regulations be mandatory, then safety norms herein will prevail.

General Health and Safety

The following table describes general health and safety information about the Eclipse radio.

Topic	Information
Flammability	The equipment is designed and constructed to minimize the risk of smoke and fumes during a fire.
Hazardous Materials	No hazardous materials are used in the construction of the equipment.
Hazardous Voltage	The Eclipse system meets global product safety requirements for safety extra-low voltage (SELV) rated equipment where the input voltage <i>must</i> be 48 V nominal, 60 V maximum.
Safety Signs	External warning signs or other indicators on the equipment are not required.
Surface Temperatures	The external equipment surfaces do become warm during operation due to heat dissipation. However, the temperatures reached are not considered hazardous.

Operator Health and Safety

The following table describes the precautions that relate to installing or working on the Eclipse radio.

Topic	Information
Equipment Protrusions	The equipment has been designed to be free of unnecessary protrusions or sharp surfaces that may catch or otherwise cause injury during handling. However, always take care when working on or around the equipment.
Laser and Fiber Optic Cable Hazards	<p>Eclipse fiber optic transmitters are IEC60825-1 / 21CFR1040-1 Class I compliant and present no danger to personnel in normal use. However:</p> <p>Do not look into active unterminated optical ports or fibers. If visual inspection is required ensure the equipment is turned off or, if a fiber cable, disconnect the far end.</p> <p>Follow the manufacturer's instructions when using an optical test set. Incorrect calibration or control settings could result in hazardous levels of radiation.</p> <p>Protect/cover unconnected optical fiber connectors with dust caps.</p> <p>Place all optical fiber cuttings in a suitable container for safe disposal. Bare fibers and fiber scraps can easily penetrate the skin and eyes.</p>
Lifting Equipment	Be careful when hoisting or lifting the antenna during installation or maintenance. Antennas with their mounting hardware can weigh in excess of 100 kg (220 lb) and require specialized lifting equipment and an operator trained and certified in its use.
Protection from RF Exposure: Eclipse	The Eclipse radio does not generate RF fields intense enough to cause RF burns. However, when installing, servicing or inspecting an antenna always comply with the Protection from RF Exposure guidelines. See RF Exposure .
Safety Warnings	When a practice or procedure poses implied or potential harm to the user or to the radio equipment, a warning is included in this manual.

General Hazards

The following table describes the general hazards that must be addressed when planning and installing an Eclipse system.

For more information on health and safety when using Aviat Networks products, refer to Aviat Networks' *Best Practices Guide*.

Topic	Information
Airflow Requirements	<p>Rack installations must be made so the airflow required for safe and correct operation of Eclipse is not compromised. For the fan-cooled Eclipse INUs and fan-cooled Eclipse IDUs, unobstructed air passage must be maintained to each side of the chassis, which requires a minimum of 50 mm (2 inches) of side spacing to any rack panels, cable bundles or similar.</p> <p>Where a Fan Air Filter is installed in an INU it must not be allowed to become clogged with dust. Replace when necessary. Inspection must be at not more than 12 monthly intervals when installed in telecommunications equipment room controlled-air environments. Otherwise, inspection is required at more frequent intervals.</p>
EMC	<p>Eclipse has been tested for and meets EMC Directive 2004/108/EC. The equipment was tested using screened cable; if any other type of cable is used, it may violate compliance.</p> <p>Eclipse is a Class A product. In a domestic environment this product may cause radio interference in which case the user may be required to take adequate measures. This equipment is intended to be used exclusively in telecommunications centers.</p>
ESD	<p>ESD (electrostatic discharge) can damage electronic components. Even if components remain functional, ESD can cause latent damage that results in premature failure. Always wear proper ESD grounding straps when changing or handling the plug-in cards and avoid hand contact with the PCB back-plane and top-plane. Connect your ESD grounding strap to the combined ESD and ground connector on the INU rack ear. Spare plug-in cards or cards to be returned for service must be enclosed in an anti-static bag. When removing a card from the anti-static bag for installation in an INU, or placing a card in a bag, do so at the INU and only when connected to the INU via your ESD grounding strap.</p>
Circuit Overloading	<p>When connecting the Eclipse, determine the effect this will have on the power supply circuit protection devices, and supply wiring. Check Eclipse power consumption specifications and the supply capability of the power supply system. This check of capacity must extend to the dc power supply and not just to an intermediate connection point.</p>
Eclipse Indoor Unit and DC Supply Grounding	<p>The ground for Eclipse indoor unit(s) must be connected directly to the dc supply system ground conductor, or to a bonding jumper from a grounding terminal bar, or bus to which the dc supply system grounding is connected.</p>

Topic	Information
Intrabuilding interfaces and cabling for NEBS compliance	<p>Intrabuilding connections to/from Eclipse ports must only be connected via intrabuilding or unexposed wiring or cabling.</p> <p>Intrabuilding ports MUST NOT be metallically connected to interfaces that connect to the OSP or its wiring. These interfaces are designed for use as intrabuilding interfaces only (Type 2 or Type 4 ports as described in GR-1089-CORE, Issue 4) and require isolation from the exposed OSP cabling. The addition of Primary Protectors is not sufficient protection in order to connect these interfaces metallically to OSP wiring.</p> <p>Shielded and grounded cables must be used for intrabuilding cabling to/from Eclipse ports. Cables must be grounded at both ends.</p>
Protection from RF Exposure	<p>When installing, servicing or inspecting an antenna always comply with the following:</p> <ul style="list-style-type: none"> • Locate the antenna such that it does not infringe the RF exposure guidelines for general public. Refer to RF Exposure. • Do not stand in front of or look into an antenna without first ensuring the associated transmitter or transmitters are switched off. • At a multi-antenna site ask the site owner or operator for details of other radio services active at the site and for their requirements/recommendations for protection against potentially harmful exposure to RF radiation. • When it is not possible to switch transmitters off at a multi-antenna site and there is potential for exposure to harmful levels of RF radiation, wear a protective suit. • Do not look into a waveguide port when the radio is active.
Fiber Optic Cables	<p>Handle optical fibers with care. Keep them in a safe and secure location during installation.</p> <p>Do not attempt to bend them beyond their minimum bend radius.</p> <p>Protect/cover unconnected optical fiber connectors with dust caps.</p>
Ground Connections	<p>There must be no switching or disconnecting devices fitted in ground conductors.</p>
Mains Power Supply Routing	<p>Eclipse dc power, IF, tributary, auxiliary and NMS cables are not to be routed with any AC mains power lines. They are also to be kept away from any power lines which cross them.</p>
Maximum Ambient Temperature	<p>The maximum ambient temperature (T_{mra}) for an Eclipse indoor unit is +45° C (113° F). To ensure correct operation and to maximize long term component reliability, ambient temperatures must not be exceeded. Operational specification compliance is not guaranteed for higher ambients.</p>
Mechanical Loading	<p>When installing an indoor unit in a rack, ensure the rack is securely anchored. Ensure that the additional loading of an Eclipse indoor unit or units will not cause any reduction in the mechanical stability of the rack.</p>

Topic	Information
Power Supply Connection	<p>The Eclipse INUs have the +ve pin on their dc power supply connector connected to chassis ground. It must be used with a -48 Vdc power supply which has a +ve ground; the power supply ground conductor is the +ve supply to the radio. For NEBS compliance the battery return connection is to be treated as a common DC return (DC-C), as defined in GR-1089-CORE.</p> <ul style="list-style-type: none"> • There must be no switching or disconnecting devices in this ground conductor between the dc power supply and the point of connection to an Eclipse system. <p>The Eclipse High Power IRU 600 supports wide-mouth +/-21 to +/-60 Vdc operation. Both pins on its power supply connector are isolated from chassis ground. For NEBS compliance the battery return connection is to be treated as an isolated DC return (DC-I), as defined in GR-1089-CORE.</p> <p>The power supply for an Eclipse system must be located in the same premises as the Eclipse system.</p>
Power Supply Disconnect	<p>An appropriate power supply disconnect device should be provided as part of the building installation.</p>
Rack Mount Temperature Considerations	<p>If the Eclipse indoor unit is installed in a closed or multi-unit rack assembly, the operating ambient temperature of the rack environment may be greater than room ambient. The maximum ambient temperature (T_{mra}) of +45° Celsius (113° F) applies to the immediate operating environment of the Eclipse indoor unit, which, if installed in a rack, is the ambient within the rack.</p>
Restricted Access	<p>The Eclipse system must be installed in restricted access sites. The indoor unit and associated power supply must be installed in restricted areas, such as dedicated equipment rooms, closets, cabinets, or the like. Access to the tower and antenna location must be restricted</p> <p>Note: For USA: In restricted access areas install the Eclipse system in accordance with articles 110-26 and 110-27 of the 2002 National Electrical Code ANSI/NFPA 70, or to any subsequent update to this code for the relevant articles.</p>

RF Exposure

To ensure compliance with the FCC RF exposure requirements, a minimum distance of 20 meters must be maintained between the antenna and any persons whilst the unit is operational. This calculation is based on the maximum conducted power and maximum antenna gain.

- Eclipse with IRU600, 5.8 GHz, has been tested and certified for use with a parabolic antenna with a maximum gain of 46.8 dBi. Higher gain antennas must not be used.
- The maximum transmit output power on the IRU 600 has been limited to a maximum of 1W (30dBm) at the antenna port, to comply with the conducted power limit in FCC CFR 47, Part 15.247.

Routine Inspection and Maintenance

This section overviews required and recommended inspection and maintenance practices to ensure health and safety of installed equipment is maintained to highest levels. For more information, refer to the Aviat publication: Best Practices.

Routine Inspections

All sites must be inspected annually, or more frequently if subject to abnormal operating conditions such as particularly exposed sites, or sites subject to salt-spray or heavy snow/ice loading over winter months.

The inspection should cover the physical installation including the antenna, waveguide, equipment grounding, tower and building grounds, weatherproofing, and general site integrity.

Where a Fan Air Filter is installed in an INU (for NEBS compliance) it must be inspected annually, or more frequently if the INU is installed in an environment that is not controlled for dust exclusion.

Selected ground wires should be resistance checked and then compared with previous checks to ensure there has been no significant change.

The operational performance of the radio and associated equipment should be checked against their as-built figures.

Trend Analysis

Use available current and historical Eclipse alarm and performance data to determine any trend that may lead to a failure - if allowed to continue.

Check for the following trends:

- Reducing receive signal levels
- Gradually increasing bit errors or an increasing errored seconds count
- Changes in transmit power
- Increasing occurrence of other weather related changes in performance
- Increasing occurrence of a particular hardware failure

Time spent in conducting such analysis is time well spent. Catching a problem before it brings down the network is good network management.

Fault Analysis

All faults, once cleared, should be the subject of a fault report. The data presented in these reports should be analyzed from time to time to check for any common threads, which may point to a particular weakness in the design, installation, or maintenance of the network or to a specific component.

The time taken to restore service and the parts used should also be analyzed to see if improvements are possible in the maintenance procedures, maintenance training and spares holdings.

Training

Properly trained and experienced planning and installation personnel are essential for establishing and maintaining high integrity in a new network. Similarly, properly trained network management and service personnel are essential for the continued good health of a network.

The training needs for personnel should be reviewed from time-to-time to ensure they maintain expertise in their area of work, and on the installed base.

Spares

Spares holdings should be reviewed on a regular basis to ensure the correct quantity and type are held, and held at the most appropriate locations.

Analysis of spares usage will show any trend for excessive use of spares, which may point to a weakness in the deployment or manufacture of the item.

Spares holdings should also be checked from time to time and if necessary brought up to the current hardware and/or software revision level.

Chapter 3. System Overview

This section overviews features and capabilities of Eclipse with IRU 600 for the 5.8 GHz unlicensed band.

Eclipse with IRU600, 5.8 GHz, is compliant with FCC CFR47, Part 15.247.

- It has been tested and certified for use with a parabolic antenna with a maximum gain of 46.8 dBi.
- The filters used in the IRU 600 RF unit allow for transmission only in the frequency range 5725 - 5850MHz to ensure compliance with Part 15.247.
- Transmit power output is limited to 1W (30 dBm) at the antenna port to comply with the conducted power limit in FCC CFR 47, Part 15.247.

Operation is all-indoor, using rack-mounted indoor units, the INU and INUe, and one or more IRU 600 RF units.

- Eclipse supports multiple radio links from a common indoor unit with throughput capacities to 189 Mbit/s Ethernet, 100xDS1, 3xDS3, or 1xOC3.
- The IRU 600 RF unit is 1+1 optimized with two RFUs and an ACU. The RFUs can be operated as independent links, or as a protected link.
- Path, equipment, and data protection options support comprehensive link, network and data redundancy.
- Plug-in cards on the INU and INUe provide a wide choice of user interfaces and radio link operation.
- The node-based concept eliminates most ancillary equipment and external cabling, and offers smooth upgrade paths for next generation networks.

Figure 4. INUe with IRU 600



MEF Certified. Eclipse meets the requirements of MEF 9 and MEF 14 for carrier-class Ethernet inter-operability and performance. MEF 9 specifies the User Network Interface (UNI). MEF 14 specifies Quality of Service (QoS).

Refer to:

- [Eclipse Indoor Units](#)
- [Eclipse IRU 600](#)
- [Platform Layout](#)
- [Protection Options](#)
- [Eclipse Licensing](#)
- [Configuration and Management](#)
- [Eclipse Antennas](#)
- [Eclipse Power Supply](#)

Eclipse Indoor Units

There are two indoor units, the INU, and INUe (extended INU). The INU is a 1RU chassis, the INUe is 2RU.

Mandatory plug-ins are the NCC (Node Control Card) and FAN (Fan card). The optional plug-ins comprise RAC (Radio Access Card), DAC (Digital Access Card), AUX (Auxiliary), NPC (Node Protection Card), and PCC (Power Converter Card).

INU

The INU requires one NCC and one FAN, and has provision for up to four option plug-ins. It supports a maximum of three RFUs for three non-protected links, or one protected/diversity link and one non-protected link. Each RFU is supported by a RAC via a single coax cable.

Figure 3-1. INU



INUe

The INUe requires one NCC and one 2RU FAN. It has provision for up to ten option cards and supports a maximum of five RFUs for five non-protected links, or two protected/diversity links plus one non-protected link.

Figure 3-2. INUe



Plug-in Cards

Plug-in cards for the INU or INUe enable quick and easy customization on Eclipse configurations. All cards are hot-pluggable.

- **RACs** support the radio modem function. In the transmit direction they take the digital traffic from the backplane or data packet plane and convert it to an IF signal for connection to an IRU600. The reverse occurs in the receive direction.
 - One RAC with one 1+0 IRU 600 is used for a 1+0 link.
 - Two RACs with one 1+1 IRU 600 are used for 1+1 or diversity links.
 - RACs control TX switching and RX voting on protected / diversity links.
 - XPIC (cross polarization interference cancellation) RACs support CCDP (co-channel dual polarization) operation.
- **DACs** support the user interface. They take the user traffic and convert it into a format compatible with the data backplane, where it cross-connects to a RAC or RACs, or to other DACs.
 - Different DACs support DS1, DS3, OC3, and Ethernet connections.
 - Multiplexer DACs support transport of OC3 or DS3 with NxDS1 rates.
 - Ethernet DACs support a L2 switch function. The GigE DAC GE supports advanced ring/mesh, link aggregation and VLAN tagging options.
 - Most DACs can be protected using a stacked (paired) configuration.
 - DS1, DS3, and OC3 DACs support Ethernet-over-TDM options to enable Ethernet transport over legacy TDM radio or leased-line links.
- **AUX** (Auxiliary card) supports async or sync service-channel connections, and alarm I/O options for connection to external devices.
- **NCC** (Node Controller Card) provides the node management and DC voltage conversion functions. The NCC is a mandatory card.
 - It manages Eclipse operation and event collection and management.

- It incorporates a router function for local and remote network management interconnection.
- Eclipse configuration and licensing data is held in flash-memory.
- Required power supply is -48 Vdc (-40.5 to -60 Vdc).
- **FAN** (Fan card) provides forced-air cooling. This is a mandatory card.
- **NPC** (Node Protection Card) provides 1+1 protection functions for the NCC power supply and backplane management.
- **PCC** (Power Conversion Card) supports operation from a +24 Vdc power supply.

Plug-in Cards Overview

RAC 60

RAC 60 supports DPP (Data Packet Plane) as well as backplane data connections, plus ACM (Adaptive Coding and Modulation) options.

Four dynamically switched modulation rates are available; QPSK, 16 QAM, 64 QAM, 256 QAM. Modulation switching is errorless for priority traffic.

Coding options additionally provide selection of two modulation states, one for maximum throughput, the other for maximum gain. These apply on each of the modulation rates of QPSK to 256 QAM to provide an effective total of eight modulation states.

- Maximum throughput delivers maximum data throughput - at the expense of some system gain.
- Maximum gain delivers best system gain - at the expense of some throughput.
- Up to four of the eight modulation states offered with ACM can be selected for use.

A DPP port enables direct routing of Ethernet traffic to a DAC GE.

Individual ACM modulation rates can be set as fixed rates. These are complemented by fixed rates for TDM (DS1, DS3, OC3) capacities.

Channel bandwidths range from 3.5 to 30 MHz.

Air-link capacities for Ethernet, or for Ethernet + DS1, extend to 189 Mbit/s.

Backplane-connected TDM options extend to 100xDS1, 3xDS3, 1xOC3.

Payload encryption is a licensed option.

RAC 60s must be used at both ends of a link, or RAC 60 with a RAC 6X in non-CCDP mode.

Figure 3-3. RAC 60



RAC 6X

RAC 6X adds CCDP operation to RAC 60 capabilities. Two RAC 6X cards are operated as a CCDP pair, either in the same INU, or in separate co-located INUs to provide double the capacity over one channel using both the horizontal and vertical polarizations. An XPIC function between the RACs ensures cross-polarization interference is eliminated.

Figure 3-4. RAC 6X



DAC GE

DAC GE interfaces three 10/100/1000Base-T electrical ports and one 1000Base-LX optical port, to one or two transport channels. Features include:

- Advanced QoS settings.
- Transparent, VLAN and mixed modes of operation.
- Enhanced, fast-switched RSTP.
- Layer 1 or Layer 2 link aggregation.
- VLAN tagging.
- DPP and backplane traffic connections.
- Inter-frame gap (IFG) and preamble stripping and re-insertion.
- Frame sizes to 9600 bytes.
- Assignment to radio or fiber links.
- SFP optical port options for 1310nm single or multi-mode, or 850nm multi-mode.
- Compatibility with DAC ES.

Figure 3-5. DAC GE



For DPP traffic a DAC GE must be operated with a RAC 60 or RAC 6X.

DAC ES

DAC ES interfaces four 10/100Base-T Ethernet ports to one or two radio and/or fiber transport channels. Features include:

- Advanced QoS settings.
- Transparent, VLAN and mixed modes of operation.
- Throughputs to 100 Mbit/s per transport channel.
- Assignment to radio or fiber links.
- Inter-frame gap (IFG) and preamble stripping and re-insertion.
- Compatibility with DAC GE.

Figure 3-6. DAC ES



DAC 16X

DAC 16x supports 16xDS1 tributaries on Mini RJ-21 connectors.

Figure 3-7. DAC 16x



DAC 4X

DAC 4x supports 4xDS1 tributaries on individual RJ-45 connectors.

Figure 3-8. DAC 4X



DAC 3xDS3

DAC 3xDS3 supports 3xDS3 tributaries on paired mini-BNC connectors.

Figure 3-9. DAC 3xDS3



DAC 3xDS3M

DAC 3xDS3M supports three operational modes:

- Normal DS3 tributary operation (as for DAC 3xDS3)
- M13 multiplexer mode. One or two DS3 interfaces are multiplexed to an NxDS1 backplane.
- DS3 Ethernet mode to enable up to 43 Mbit/s Ethernet over legacy TDM radio or leased-line links (links must support transparent DS3).

Tribs are supported on paired mini-BNC connectors.

Figure 3-10. DAC 3xDS3M



DAC 2x155e

DAC 2x155e supports two STS3 electrical tributaries on paired BNC connectors.

Figure 3-11. DAC 2x155e



DAC 1x155o

DAC 1x155o supports one OC3 single-mode optical tributary on SC connectors.

Figure 3-12. DAC 1x155o



DAC 2x155o

DAC 2x155o supports two OC3 single-mode optical tributaries on SC connectors.

Figure 3-13. DAC 2x155o



DAC 155oM

DAC 155oM multiplexes an OC3 optical tributary to an NxDS1 backplane. The user interface is provided on an SFP optical transceiver. Different SFPs support 1310nm single or multi-mode, or 850nm multi-mode.

It functions as a terminal multiplexer; it terminates or originates the OC3 frame. It does not support interconnection of ADMs as there is no provision to transport OC3 overheads for ADM to ADM synchronization.

In virtual tributary mode it transports up to 130 Mbit/s Ethernet over an OC3 link.

Options are provided for external/recovered, or internal clock sourcing.

Figure 3-14. DAC 155oM



AUX

AUX provides synchronous and/or asynchronous auxiliary data channels, NMS porting, and alarm input and output functions. Data options are sync at 64 kbps or async to 19.2 kbps.

Figure 3-15.



NCC

The NCC is a mandatory plug-in for an INU/INUe. It performs key node management and control functions, and provides various dc rails from the -48 Vdc input. It also incorporates a plug-in flash card, which holds Node configuration and license data.

Power input limits are -40.5 to -60 Vdc. The power connector is a D-Sub M/F 2W2. The +ve dc return pin is connected to chassis ground.

Figure 3-16. NCC



FAN

The FAN is a mandatory plug-in. There are two variants, 2RU and 1RU. Each is fitted with two long-life axial fans plus monitoring and control circuits.

- One 1RU FAN is fitted in an INU.
- One 2RU FAN is fitted in the INUe.

Figure 3-17. FAN (1RU)



NPC

NPC provides redundancy for the NCC TDM bus management and power supply functions.

Figure 3-18. NPC



PCC

The PCC provides a voltage conversion function for locations where the power supply is +24 Vdc. It converts +24 (19 to 36) Vdc to -56 Vdc for connection to the INU -48Vdc input. -56 Vdc represents the typical float voltage for a battery-backed -48 Vdc supply.

One PCC supports a maximum three IRU 600 RFUs, plus any combination of RACs and DACs.

Figure 3-19. PCC



Eclipse IRU 600

The IRU 600 is a 3RU rack-mounted transceiver unit for co-location with an INU/INUe as an all-indoor installation.

IRU 600 is 1+1 optimized with provision for two RFUs (Radio Frequency Unit) and a companion filter-based ACU (Antenna Coupler Unit).

High power and standard power RFUs are available. Both are highly energy efficient. (50W power consumption for standard power, 98W for high power).

Transmit power output is limited (applies on the high power RFU) to a maximum of 1W (30dBm) at the antenna port to comply with the conducted power limit in FCC CFR 47, Part 15.247.

- Standard power RFUs are powered over the IF cable from its INU/INUe.
- High power RFUs are additionally powered using a separate DC input on the RFU front panel.
 - The power connector (D-Sub M/F 2W2) and cable is identical to that used for the INU.
 - The high power RFU provides a wide-mouth connection for +/- 21 to 60 Vdc. Both +ve and -ve pins are isolated from ground.
 - An integral DC/DC converter provides polarity protection, under/over voltage shutdown, over-current limit, and thermal shutdown.
 - NEBS compliant EMI filtering is included.

There are no serviceable fuses.

The ACU design supports paired and unpaired Tx/Rx frequency splits and incorporates an optional expansion port to allow other radio links onto its waveguide feed for co-path operation.

The IRU 600 also supports 1+0 repeater (back-to-back) operation. The links may be in the same or different bands.

Protected/diversity options include:

- 1+1 hot-standby, single antenna, with equal or unequal split.
- 1+0 hot-standby-ready.
- Space diversity (dual antennas) with common or split Tx.

Figure 3-20. Low Power IRU 600



Platform Layout

Eclipse supports flexible customization of traffic type, traffic capacity, and traffic protection.

Table 3-1 lists INU and INUe platform support for:

- Non-protected and protected/diversity links
- Slot availability for option plug-ins
- Over-air data types supported
- IRU 600

Table 3-1. INU and INUe Platforms



<p>INU</p>  <p>INUe</p>  <p>IRU 600</p> 	<ul style="list-style-type: none"> • Supports 3 non-protected links or 1 protected/diversity and 1 non-protected link • Slots 1 to 4 support radio or traffic port options for: <ul style="list-style-type: none"> • Ethernet, DS1, DS3, OC3 • Auxiliary data and alarm I/O • NPC option may only be installed in slot 4 • Supports up to five 1+0 RAC 60 links or four RAC 6X links <ul style="list-style-type: none"> • Supports two 1+1 protected links (4xRACs) • Slots 1 to 6 support radio or port options. Slots 7 to 9 support port options only. Port traffic options include: <ul style="list-style-type: none"> • Ethernet, DS1, DS3, OC3 • Auxiliary data and alarm I/O • Slot 10 is reserved for the NPC option • IRU 600: <ul style="list-style-type: none"> • QPSK to 256 QAM. • Requires RAC 60 or RAC 6X. Fixed or adaptive modulation rates. • 1+1 optimized. • High power and standard power RFU options

Table 3-2 lists INU and INUe slot assignment rules.

Table 3-2. INU and INUe Slot Assignments

INU/INUe	Slots
<p>INU</p>  <p>The diagram shows a 2x4 grid of slots. The top row contains Slot 1, Slot 2, Slot 3, and a Fan slot. The bottom row contains an NCC slot and Slot 4.</p>	<ul style="list-style-type: none"> • Slots 1, 2, 3, 4 are universal: any RAC, DAC or AUX plug-in • Slot 4 is NPC or universal: NPC or any RAC, DAC, AUX • NCC and FAN slots are dedicated • For protected operation the RAC/RAC, RAC/DAC 155oM, or DAC/DAC pairings can be installed in any of the universal slots
<p>INUe</p>  <p>The diagram shows a 3x4 grid of slots. The top row contains Slot 1, Slot 2, Slot 3, and a Fan slot. The middle row contains Slot 4, Slot 5, Slot 6, and another Fan slot. The bottom row contains Slot 7, Slot 8, Slot 9, and Slot 10. An NCC slot is located below Slot 7 and Slot 8. Red arrows indicate connections between Slot 1 and Slot 4, Slot 2 and Slot 5, and Slot 3 and Slot 6.</p>	<ul style="list-style-type: none"> • Slots 1, 2, 3, 4, 5, 6 are universal: any RAC, DAC or AUX plug-in • Slots 7, 8, 9 are restricted: any DAC or AUX, except DAC 155oM and AUX <i>where NMS access is required</i>¹ • Slot 10 is restricted: NPC option only • NCC and FAN slots are dedicated - the INUe is supplied standard with a single 2RU FAN, though accepts two 1RU FANs • RAC/RAC, or RAC/DAC 155oM protected pairings must be installed in the positions indicated by the arrows • For protected DACs, the protection partners can be installed in slots 1 to 9, except for the DAC 155oM where NMS access is needed, in which case install only in slots 1 to 6

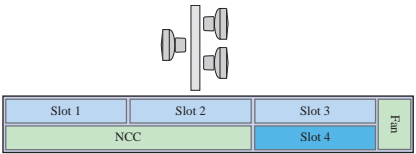
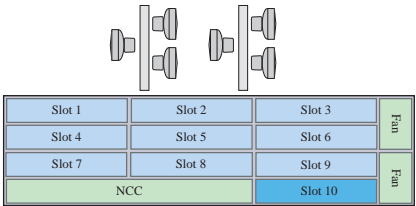
1. Internal (backplane bus) NMS access is only provided on slots 1 to 6. Do not install DAC 155oM or AUX in slots 7 to 9 if an NMS connection is required in their configuration.

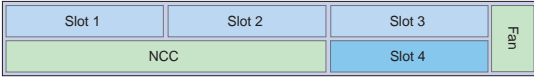
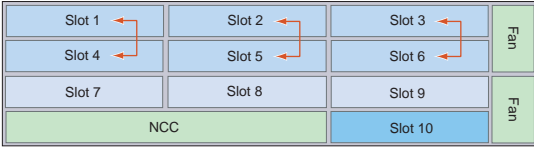

Data is transported natively over an Eclipse wireless link, whether Ethernet or TDM.

Protection Options

Eclipse supports link, interface, network, and platform protection options:

Link/Path Protection

Hot-standby, space diversity, frequency diversity, or dual protection options are available. RACs and their companion IRU 600 are protectable.

Rx voting is hitless/errorless; Tx switching is not hitless. The maximum restoration time for a Tx switch is 200 ms.

A remote Tx switch is forced in the event of a silent Tx failure.

Interface Protection

DS1, DS3 and OC3 interfaces can be hot-standby protected using paired (stacked) DACs.

The protectable DACs are DAC 16x V2, DAC 3xDS3, DAC 3xDS3M, DAC 2x155o, DAC 2x155e, DAC 155oM.

When a switch occurs, all Tx and/or Rx tributaries are switched to the protection partner.

Two protection configurations are supported, tributary protection, and always-on:

Tributary Protection

- Y cables connect the paired DACs to customer equipment.
- In the Rx direction (from the customer) both DACs receive data, but only the online Rx DAC sends this data to the TDM bus.
- In the Tx direction, the online Tx DAC sends data to customer equipment, the other mutes its Tx line interface.

Tributary Always-On

- Separate cables connect each DAC to customer equipment.
- In the Rx direction (from the customer) both DACs receive data, but only the online Rx DAC sends this data to the TDM bus.

In the transmit direction both DACs send data to customer equipment, and the customer equipment switches between these two always-on tributaries.

Protection switching is not hitless. The maximum restoration time for a Tx or Rx trib switch is 200 ms. Typical restoration times are between 80 ms and 120 ms.

Network/Data Protection

- RWPR™ supports fast-switched RSTP on Ethernet ring and mesh networks.
- Data redundancy is supported on Ethernet link-aggregated links.
- Super PDH ring operation supports protection on NxDS1 ring links.

Ring and Mesh Networks

RWPR™ (Resilient Wireless Packet Ring) is a fast-switched RSTP link management protocol for layer 2 switches. RSTP, itself a fast switched evolution of the original STP, prevents live network loops and provides path redundancy where two or more paths exist between network nodes.

- RWPR represents a particularly effective enhanced RSTP protocol. When configured in Eclipse ring networks, reconvergence times are as low as 50 mS.

Link Aggregation 2+0 Protection

Traffic redundancy is supported on co-channel Ethernet links using link aggregation. If one link fails, then its traffic is recovered on the remaining link or links is shared. While the reduced bandwidth may result in some traffic loss for low-priority traffic, appropriate QoS settings should ensure security for all higher priority traffic. This is often referred to as 2+0 protection.

Super PDH

Super PDH™ is exclusive to the Eclipse. It supports protected PDH ring configurations for capacities to 84xDS1, with traffic switching at the node level.

A ring (closed loop) is formed by east/west facing RAC and RFU combinations from an Eclipse node; each node is connected to two adjacent nodes, the east and west nodes.

Within the ring there are two traffic rings, one nominated as clockwise, the other anti-clockwise. Under normal no-fault conditions, all traffic is passed on the clockwise primary ring.

When a fault occurs, the secondary, anti-clockwise ring, provides the protection capacity needed. Traffic is looped onto the secondary ring at one side of the break point, and off at the other side, to bypass the break. This process is called wrapping.

One or more radio paths can be replaced by a fiber span using the DAC 155oM.

Platform Protection

Platform management functions provided by the NCC are protected using the NPC option to protect essential Backplane Bus and power supply functions.

Bus Protection

- Protects all circuit/tributary traffic. Alarm I/O is not protected.
- Switching is not hitless for an NCC bus clock failure; restoration is within 200 ms, during which time all traffic on the NTU is affected.
- When the bus clock has switched to NPC control, it will not automatically revert to NCC control on restoration of the NCC. Return to NCC control requires either withdrawal/failure of the NPC, or use of diagnostic commands.

Power Supply Protection

- Protection is hitless for an NCC power supply failure. If the NCC converter or one of its supply rails fails, the NPC will take over without interruption. And vice versa.
- With an NPC installed, the NCC can be withdrawn and replaced without further impacting traffic.
- For 24 Vdc operation two PCCs are required for platform protection, one each for the NCC and NPC.

Eclipse Licensing

Eclipse is subject to capacity and feature licensing.

Feature Licensing applies on selected features. Currently six features available.

- **EZF-01: Layer 1 Link Aggregation** (DAC GE). Traffic is between the links on a byte-by-byte basis, based on the capacity of the links. Unlike L2, it is fully effective for just one active session, such as between routers, or where there are only a few concurrent sessions.
- **EZF-02: Adaptive Modulation**. Eclipse adaptive coding and modulation (ACM) dynamically switches between QPSK, 16 QAM, 64 QAM, or 256 QAM. Code settings additionally provide two sets of rates for each modulation; one for maximum-throughput, the other for maximum-gain, to provide eight modulation states in total.
- **EZF-03: Secure Management** (NMS). Applies to Eclipse NMS access over the network, and to local access via the Portal craft tool. It also enables secure management access to Eclipse over an unsecured network, and protects Eclipse configurations from accidental or intentional modification by unauthorized personnel.
- **EZF-04: Payload Encryption**. Encrypts all traffic and management data over the wireless link to prevent eavesdropping.
- **EZF-05: Ethernet over TDM** (DS3, DS1). Enables mapping of Ethernet data to DS3, or DS1 PDH interfaces using the DAC 3xDS3M or DAC 16xV2. Supports transport of Ethernet data over existing DS3 or NxDS1 radio or leased-line circuits.
- **EZF-06: RADIUS Client**. Enables connection validation to a radius server for centralized account management.

Configuration and Management

Eclipse is a software-driven product; there are no manual controls. Configuration and management is achieved via Portal and ProVision.

- Portal is a PC based configuration and diagnostics tool for Eclipse.
- ProVision is the Eclipse network element manager. ProVision also supports other Aviat products, including legacy products.

Portal is supported in the Eclipse system software, such that once installed on a PC, it automatically downloads support from the radio as needed to ensure Portal always matches the version of system software supplied, or subsequently downloaded in any radio upgrade.

Portal has the look and feel of a Windows environment with screen-based views and prompts for all configuration and diagnostic attributes.

A Portal PC connects to an INU/INUe/IDU using Ethernet or V.24 options.

For more information, refer to the Eclipse Configuration Guide.

ProVision is the network element manager for all Aviat radios (current and legacy). ProVision also supports partner products, including multiplexors, switches, routers, and power systems.

ProVision is installed on a Windows or Solaris server, typically at a network operating center, and communicates with network elements using standard LAN/WAN IP addressing and routing; each radio has its own unique IP address.

For more information, refer to the Aviat ProVision User Guide.

Eclipse Antennas

Antennas for the 5.8 GHz unlicensed band must be FCC approved.

Antenna gain must not exceed 46.8 dBi.

For information on antenna types and availability, contact Aviat Networks or your supplier.

Antenna mounts are designed for use on industry-standard 115 mm OD (4.5 inch) pipe-mounts.

For information on installing and aligning antennas, refer to the data supplied with the antennas.

Eclipse Power Supply

Eclipse is designed to operate from a -48 Vdc power supply (+ve earth) but will operate to specification over a voltage range of -40.5 to -60 Vdc.

A plug-in PCC option provides a voltage conversion function for locations where the power supply is +24 Vdc. It converts + 24 (19 to 36) Vdc to -56 Vdc for connection to the INU -48Vdc input. -56 Vdc represents the typical float voltage for a battery-backed -48 Vdc supply.

One PCC supports a maximum three IRU 600 RFUs, plus any combination of RACs and DACs.

The dc power supply must be UL or IEC compliant for SELV (Safety Extra Low Voltage) output (60 Vdc maximum limited).

Chapter 4. Introduction to Eclipse Installation

This section introduces Eclipse installation procedures, from unpacking and checking the equipment to completion of the physical installation.



Eclipse has been tested for and meets EMC Directive 2004/108/EC. The equipment was tested using screened cable; if any other type of cable is used, it may violate compliance.



Eclipse is a Class A product. In a domestic environment it may cause radio interference: be prepared to resolve this. Eclipse equipment is intended to be used exclusively in telecommunications centers.



You *must* comply with the relevant health and safety practices when working on or around Eclipse radio equipment. Refer to [Health and Safety](#).

Before Going On Site

Installation Tools and Materials

Ensure you have the following tools and material before going to site. These items that be sourced or supplied by the installer.

Table 4-1. Required Tools and Material

Equipment	Tool/Material	Description
Antenna	As required by the manufacturer	Aviat Networks offers antennas from several suppliers. Refer to the manufacturer's data supplied with each antenna for required and recommended installation tools and equipment. Antennas must be FCC approved for 5.8 GHz unlicensed band operation.

Equipment	Tool/Material	Description
Eclipse Radios	Basic electrician's toolkit	The kit must include a crimp lugs, a crimp tool for attaching the lugs to stranded copper cable, and a multimeter.
	Torque wrench	Capable of 66 N-m or 50 ft-lb, with a selection of sockets for antenna mount fastening
	Hot-air gun	For use on the heat-shrink tubing that may be supplied with some brands of Type N connector.
	Protective grease and zinc-rich paint	For weather-protecting grounding attachment points on towers and grounding bars.
	4mm ² (#12) green PVC insulated strand copper wire and grounding lugs	For grounding the indoor unit to the rack/frame
	16 mm ² (#6) green PVC insulated strand copper wire and grounding lugs	For grounding the rack to the station ground. 16mm is also required for chassis grounding for NEBS compliance.

Unpacking the Eclipse Equipment

To unpack Eclipse equipment:

1. Open the shipping boxes, carefully remove the equipment and place it on a clean, flat working surface.
2. Ensure all the basic components and accessories for your system have been included in the shipment by comparing the packaging, component part numbers and product descriptions against the packing list, and cross-checking against the installation datapack for the system to be installed.
3. If there has been shipping damage or there are discrepancies between the equipment expected and the equipment received, contact an Aviat Networks Help Desk or your supplier.

Chapter 5. Installing the IRU 600

Before installation and commissioning of the IRU 600 and companion INU, its antenna, waveguide, and waveguide pressurization equipment must be installed according to manufacturer's instructions.

For compliance information, refer to [Compliance and Notices](#).

For health and safety information, refer to [Health and Safety](#).

For information on installing an INU, refer to [Installing the INU and INUe](#).

For general guidance on installing antennas, waveguide and pressurization equipment, see the Best Practices Guide from Aviat Networks.

IRU 600 Installation Procedure

1. Fit the rack mounting brackets onto the chassis. Brackets can be mounted in either a forward mount or a flush mount position.
2. Install the chassis. If installing multiple chassis, consider leaving a 3 RU space between to allow for an expansion or extension kit(s).
3. Locate and secure RFU(s) and ACU in the chassis.
4. Connect the RFU(s) to the ACU using the supplied RF cables.
5. Using the supplied IF cable(s), connect the RFU(s) to the INU/INUe RAC 60 or RAC 6x card(s). The minimum bend radius of the IF cable is 25mm (1").

Figure 5-1. IRU 600 and INU



Ventilation Requirement



There must be a minimum of 50 mm (2") of side spacing from the INU/INUe to any rack panels, cable bundles or similar, and 50 mm (2") of space to the front and back of the RF section to ensure proper ventilation.

Grounding

The grounding stud as shown in [Figure 5-2](#) will accommodate a wrist strap using the jack at the front. It also will accommodate cable up to 16 mm² (AWG 6). The cable can be threaded through the side holes and then secured by tightening the screw located on the front of the grounding post. The grounding post is a pinned to prevent rotation.

1. Ground the IRU 600 from the grounding stud to the rack/frame ground bar using a length of 4 mm² (AWG 12) green PVC insulated stranded copper wire with a suitably sized crimp lug at each end (supplied by the installer).

For NEBS compliance, 16mm² (AWG 6) green PVC insulated stranded copper wire is required together with a star washer under the grounding screw. Grounding post screws must be torqued to 1.2-1.5 Nm (10-13 in-lbs).

2. If the equipment rack/frame requires grounding, use 16 mm² (AWG 6) wire from its ground bar to the station ground.

Figure 5-2. Grounding Point Detail



Safety Requirements for Equipment Grounding

1. Ground wires must provide a direct, low impedance path to the Master Ground bar for the building, which should be located adjacent to the point of waveguide entry to the building.
2. Do not connect other equipment to the same grounding cable as the IRU 600. Each item of equipment in a rack must be separately grounded to the rack ground bar. The rack ground bar is then grounded directly to the building Master Ground.
3. The IRU 600 and INU must be located in the same immediate area (same or adjacent racks/cabinets) as with any other equipment that is connected to the same DC supply circuit point of grounding. **DO NOT** ground the INU and IRU 600 elsewhere.
4. All intra-building signal cabling must be shielded and both ends of each shield must be grounded.
5. There shall be no switching or disconnecting devices in the grounded circuit conductor between the DC source and the point of connection of the grounding electrode conductor.

Waveguide Grounding

Grounding the waveguide is an essential part of the overall lightning protection scheme at the site. The number of waveguide grounds required is dependant on the antenna height at its centerline. At a height of 45m, the minimum number of waveguide grounds required is 3:

- One located at the top of the vertical waveguide run, about 1 meter below the bend before the waveguide goes horizontal toward the antenna,
- One located at the bottom of the vertical cable run, about a meter above the bend before the waveguide goes horizontal toward the equipment room entry point,
- One located at the equipment room entry way point.

The top and bottom ground is typically connected to a tower ground bar, or to the tower steel using a ground clamp. The entryway ground should be attached to the ground bus bar, generally located directly below the waveguide entryway point.

If the height of the antenna centerline is greater than 45m, then additional grounds are required every 25m, or part of, above the 45m level. The topmost one should be located about 1 meter below the bend before the waveguide goes horizontal toward the antenna.

NEBS Compliance

For NEBS compliance:

- The equipment is to be grounded to a Common Bonding Network.
- All bare conductors must be coated with an appropriate antioxidant compound before crimp connectors are fitted.
- All unplated connectors, braided strap, and bus bars must be brought to a bright finish and then coated with an antioxidant before they are connected. This does not apply to tinned, solder-plated, or silver-plated connectors and other plated connection surfaces – but all must be clean and free of contaminants.
- All raceway fittings must be tightened to provide a permanent low-impedance path.

Connect Waveguide(s) to Antenna Ports(s)

Connect the ACU antenna port(s) to the main waveguide(s) using appropriate lengths of flexible waveguide.

For information on required waveguide flanges, and recommended waveguide type, refer to [Table 5-1](#).

Remove and discard any protective flange/port covers before installation.

Figure 5-3. ACU and Waveguide Connection

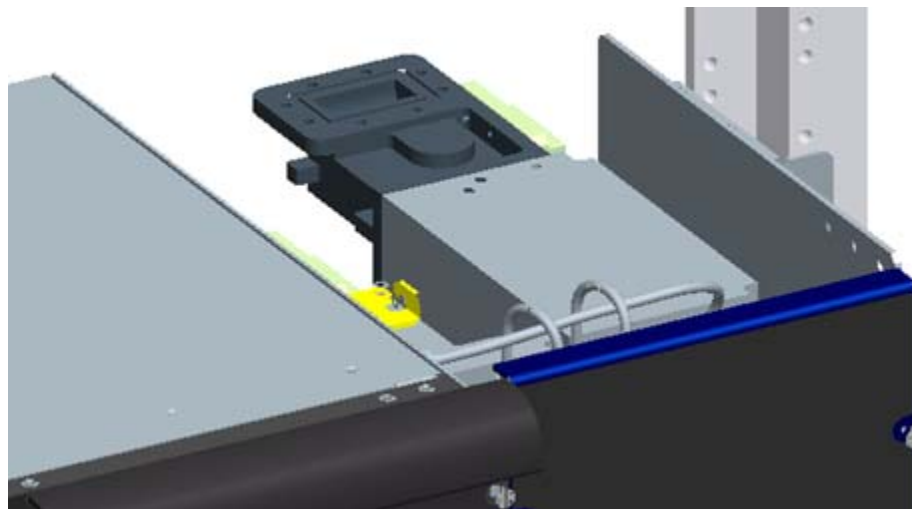

Table 5-1. Waveguide Flange Type

Freq, GHz	Flange Type	Holes	Waveguide
6	• CPR 137 G	• All open for # 6-32 screws	• WR 137
7	• CPR 112 G	• 8 x #10-32 tapped holes	• WR 112
8	• CPR 112 G	• 8 x #10-32 tapped holes	• WR 112
10, 11	• CPR 90 G	• 8 x #8-32 tapped holes	• WR 90

Power Supply

Standard power RFUs are powered over the IF cable from its INU/INUe.

High power RFUs are *additionally* powered using a separate DC input on the RFU front panel.

- The high power RFU provides a wide-mouth connection for +/- 21 to 60 Vdc. Both +ve and -ve pins are isolated from chassis ground.
- The power connector (D-Sub M/F 2W2) and cable is identical to that used for the INU. See [Power Cables](#).
 - Run the supplied power cable through to the power pick up point, which should be protected by a circuit breaker or fuse in the rack. The circuit breaker or fuse should have maximum capacity of 8 A.
 - For a -48 Vdc supply, connect the blue wire to -48 Vdc (live), and the black wire to ground/+ve.

- For a +24 Vdc supply, connect the blue wire to +24 Vdc (live), and the black wire to ground/-ve.
- For NEBS compliance the battery return connection is to be treated as an isolated DC return (DC-I), as defined in GR-1089-CORE.
- An integral DC/DC converter provides polarity protection, under/over voltage shutdown, over-current limit, and thermal shutdown.
- NEBS compliant EMI filtering is included.
- There are no serviceable fuses.



DC power connector can be shorted inadvertently if applied at an angle. Always insert with correct alignment.

Next step: Install the INU/INUe.

Chapter 6. Installing the INU and INUe

The INU and the INUe are the Eclipse indoor units.

This chapter includes:

- [INU/INUe Description](#)
- [INU/INUe Installation Requirements](#)
- [Plug-in Installation Requirements](#)
- [Installing an INU](#)

For compliance information, refer to [Compliance and Notices](#).

For health and safety information, refer to [Health and Safety](#).

For information on installing an IRU 600, refer to [Installing the IRU 600](#).

INU/INUe Description

The INU/INUe is a rack-mounted unit that pairs with one or more IRU 600s to make an Eclipse node.

An INU/INUe comprises a chassis (IDC/IDCe) and plug-ins.

The IDC/IDCe has dedicated slots for the NCC and FAN plug-ins, and either four slots (IDC) or ten slots (IDCe) available for optional RAC, DAC, AUX and NPC plug-ins. For slot allocations and assignments, refer to .

Refer to:

- [INU Front Panel Layout](#)
- [INU Power Supply](#)
- [Fuses](#)
- [FAN Air Filter Option](#)
- [Power Line Filter Option](#)

INU Front Panel Layout

This figure is an example of an INU front panel, with one DAC 16x, two RACs, and a blanking panel over the unused slot. For information on the plug-ins, refer to [System Overview](#).

Figure 6-1. Typical INU Front Panel Layout

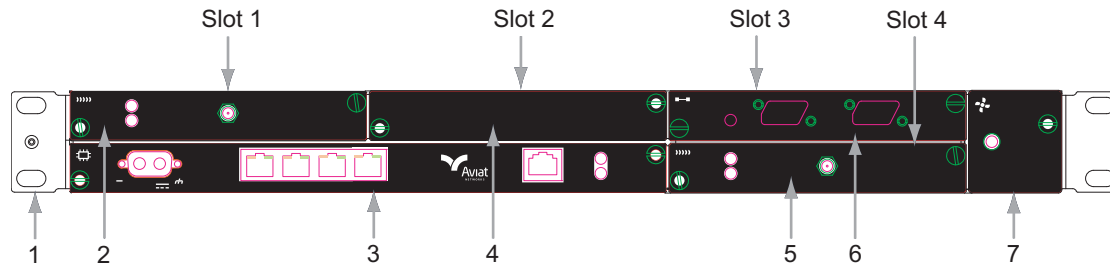

No	Item/Label	Description
1	Rack Ear and grounding stud	Rack attachment bracket for the IDC. One ear has a combined ESD and IDC grounding stud. The ears can be fitted either side, which provide flush-with-rack-front mounting.
2	RAC	RAC fitted in slot 1
3	NCC	Mandatory node Control Card (dedicated slot)
4	Blank Panel	Blanking panel fitted to slot 2
5	RAC	RAC fitted in slot 4
6	DAC 16x	16xDS1 DAC fitted in slot 3
7	FAN	Mandatory fan plug-in (dedicated slot)

INU Power Supply

INUs require a -48 Vdc power supply (+ve earth), but will operate to specification over a voltage range of -40.5 to -60 Vdc.

The return (+ve) pin on the NCC and NPC power supply connectors is clamped to chassis ground via polarity-protecting power FETs.

- NCC and NPC power inputs are reverse polarity protected (the input fuse will not blow if polarity is reversed).

For NEBS compliance the battery return connection is to be treated as a common DC return (DC-C), as defined in GR-1089-CORE.

Where operation from a +24 Vdc PSU is required, the plug-in PCC option provides voltage conversion from + 24 (19 to 36) Vdc to -56 Vdc for connection to the NCC -48Vdc input. -56 Vdc represents a typical float voltage for a battery-backed -48 Vdc supply.

The dc power supply must be UL or IEC compliant for SELV (Safety Extra Low Voltage) output (60 Vdc maximum limited).

Power Consumption and INU Load Maximums

Total power consumed is dependent on the number and type of plug-in cards, and the number and type of IRU 600s.

- The number and type of RACs and DACs that can be installed in an INU are determined by the load capacity and temperature limits of the DC converter in the NCC, which supplies various DC rails to the plug-in cards.
- IRU 600s and FANs are not powered via the NCC *converter*. Their DC supply is taken directly from the INU -48 Vdc power supply input connector.
- However, if a PCC is installed for +24 Vdc operation, the INU cards *and* associated IRU 600s are supplied from the PCC, meaning PCC power limits are determined by the INU cards *and* by the number of IRU 600s fitted.

Node Power Consumption

Table 2 lists nominal power consumption figures for Eclipse cards. Use these together with the IRU600 consumption figures in the following table to determine total nodal power consumption.

Power consumption figures are for a -48 Vdc supply voltage at normal room ambients.

Table 2. Typical Plug-in Power Consumptions

Item	Consumption
RAC 60	12W
RAC 6X	13W
DAC (Any variant)	3W
NCC	4W
NPC	4W
AUX	3W
FAN 1RU	2W
FAN 2RU	4W

Table 3 provides nominal figures for an IRU 600.

- For a standard power RFU, power is provided via its RAC - RFU cable.
- For a high power RFU, power is supplied via its RAC cable *and* additionally by a front-mounted DC connector.

Table 3. Nominal IRU 600 Power Consumptions

Configuration	Power Sourced from INU	Power Sourced from External DC Connector	Total DC Power
1+0 Standard Power (1xRFU)	52W	N/A	52W
1+0 High Power (1xRFU)	52W	38W	90W
1+1 Standard Power (2xRFU)	82W	N/A	82W
1+1 High Power (2xRFU)	82W	42W	124W

Configuration	Power Sourced from INU	Power Sourced from External DC Connector	Total DC Power
1+1 FD Standard Power (2xRFU)	104W	N/A	104W
1+1 FD High Power (2xRFU)	104W	76W	180W

Node Card Maximums

The following guidelines should be used to determine maximum INU card/power loadings for various node (INUe) configurations. Maximums are primarily determined by operating temperature limits imposed on the DC converter modules in the NCC (and NPC).

These card maximums apply up to the maximum ambient of 45°C (112°F). Higher loadings may be permitted for lower ambients. Note that for cabinet-mounted INUs the ambient temperature is the temperature within the cabinet.

INUe card loading maximums are:

- Five RAC 60 cards plus any three DACs
- Four RAC 6X cards plus any three DACs.

Note that:

- RACs should always be installed on the FAN side of the INU for best cooling efficiency.
- A 2RU FAN¹ must always be used in an INUe with a high card loading. It provides superior cooling compared to two 1RU FAN modules.
- Elevated ambient temperatures should be avoided. The 45°C (112°F) ambient maximum must not be exceeded. Over-temperature operation is a primary factor affecting long term component reliability.

PCC +24 Vdc Operation

The PCC is for use with standard +24 Vdc (-ve grounded) battery-backed power supply systems. One PCC supports a maximum three IRU 600 RFUs, plus any combination of RACs and DACs.

- The PCC +ve and -ve input terminals are isolated from chassis (ground). The -ve input is grounded by the -ve grounded power supply connection.
- The PCC 20A fuse is fitted in the +ve input. It is a PCB mount type and is not field replaceable.
- Reverse polarity protection is provided. The PCC will automatically recover from a reverse polarity connection - the fuse will not blow. Over temperature thermal protection is included.
- The PCC load maximum is 200 Watts. Use the power consumption data in the preceding section to determine the maximum number of cards and RFUs that can be supported.
- The PCC conversion efficiency is nominally 10%. To determine the power consumed by the PCC, use a figure of 10% of the power consumed by the INU/INUe cards and IRU 600 RFUs.

¹ A 2RU FAN is standard with an INUe, but an INUe can be fitted with two 1RU FANs.

- When installed in an INUe, the INUe must be fitted with the 2RU FAN module as it provides almost double the air flow of two 1RU FAN modules.
- The PCC should always be installed next to the FAN card to get best air flow cooling.
- The PCC must be connected to the NCC before applying power to the PCC to avoid a current-inrush trip (overload) on the PCC.
- The PCC can be plugged into any INU/INUe option slot. It is not connected to the backplane and its function is not monitored within Portal.
- Where an NPC is fitted, two PCCs are required for +24 Vdc operation, one for the NCC, the other for the NPC. This means an INUe must be used for NCC + NPC operation.
- If the PCC front-panel LED is not lit, it indicates the existence of abnormal conditions such as output under-voltage, output over-voltage, loss of input power, output over-current, or open input fuse.

Power Cables

The INU power cable is included in the IDC Installation Kit. It is supplied with a D-sub M/F 2W2 connector fitted at one end and wire at the other. The cable is nominally 5 m (16 ft), and the wires are 4 mm² (AWG 12).

The cable is used for -48 Vdc connections to an NCC or NPC, or for +24 Vdc connections to a PCC.

The blue wire must be connected to live (-48 Vdc or +24 Vdc); the black wire to ground (+48 Vdc or -24 Vdc).

Figure 6-4. Power Cable and Connector

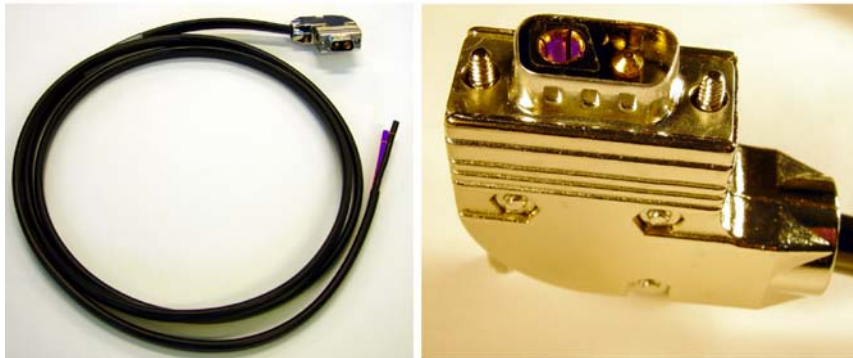

DC power connector can be shorted inadvertently if applied at an angle. Always insert with correct alignment.

The PCC is supplied with a power cable to connect to an NCC or NPC.

Similarly, the power line filter unit is supplied with a power cable to connect to an NCC, NPC, or PCC.

This cable is fitted with a D-sub M/F 2W2 connector at each end. Note that a standard power cable is not included for the reason the cable supplied with an NCC (or NPC) is not used when powered from a PCC, or via a power line filter, so the cable is re-used as the power input cable for the PCC or filter unit.

Fuses

The NCC and NPC are fitted with a fast-acting 25 A fuse fitted on the PCB behind the power cable connector.

The PCC is fitted with a fast-acting PCB-mounted 20A fuse.

NCC, NPC and PCC fuses are not field-replaceable.

FAN Air Filter Option

A fan air filter option is available for installation with the FAN module in an INU, and with the 2RU FAN module in an INUe. Where Eclipse is required to be NEBS (Network Equipment-Building System) compliant, the fan air filter *must* be installed.



The fan air filter must be inspected regularly and replaced when dust laden. In normal telecommunications equipment-room environments inspection must be at not more than 12 monthly intervals. In other environments where air quality is not controlled, more frequent inspection is required.



A heavily dust-laden filter will severely restrict fan air flow and may lead to over-heating.

Excessive heat is the number one cause of premature equipment aging and failure.

To maximize long term component reliability, the fan air filter must not be allowed to become clogged, and ambient temperature limits must not be exceeded.

Fan Air Filter Installation

The fan air filter kit comprises a filter frame, filter element, and fastening screw. It is installed in the INU/INUe to the right side of the FAN module, as illustrated in Figure 6-5 for an INUe.

1. Remove the FAN module and slide the air filter into the chassis so that it locates to the right side of the FAN module backplane connector, and up against the chassis side.

FAN module removal and replacement does not affect INUe traffic.

2. Fasten in place using the screw supplied. Do not over-tighten - the screw is designed to bite into the unthreaded hole provided in the plastic frame.
3. Replace the FAN module.

Installation instructions are included with the fan filter kit.

Figure 6-5. Location of Fan Air Filter in INUe

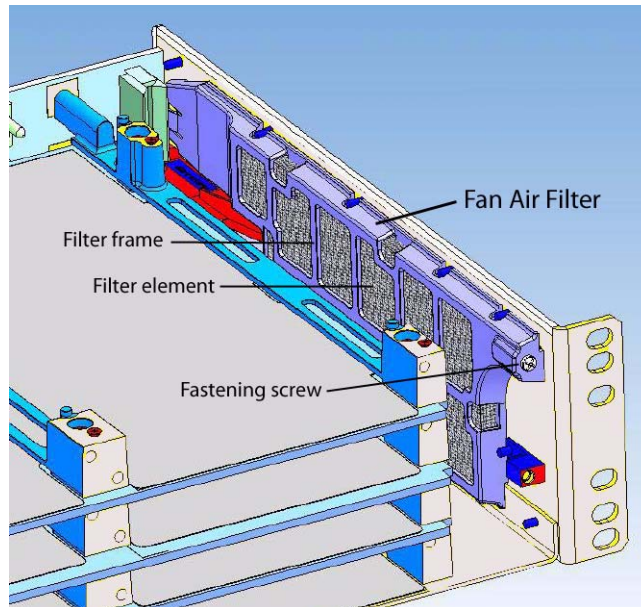

Power Line Filter Option

An external DC power line filter option is available and must be installed with an INU/ INUe for NEBS compliance. It ensures Eclipse meets EMI requirements specified within Telcordia GR-1089-CORE, Issue 4, June 2006.

It is 1RU tall and 140mm wide (5.5”), and is supplied as a kitset comprising the filter unit, bracket for left or right side rack mounting, and a short 2W2-to-2W2 cable for connecting the filter unit to the NCC or NPC -48 Vdc inputs.

- Where an NPC is fitted, two filter units are required, one for the NCC, the other for the NPC.
- The standard power cable supplied with an INU or NPC is re-used as the power input cable for the filter unit.

Figure 6-6. Power Line Filter with Bracket



INU/INUe Installation Requirements

Table 6-1. INU Installation Requirements

Function/Requirement	Details
Restricted access	<p>The INU/INUe and its associated dc power supply must be installed in a restricted access area such as a secure equipment room, closet, or cabinet.</p> <p>For NEBS compliance, this equates to installation of the INU/INUe in a secure, restricted access central office (CO) or customer premises (CP) location.</p>
Required Rack Space	The INU requires 44.5 mm (1RU) of vertical rack space and 300 mm rack depth. The INUe requires 89mm (2RU) vertical rack space.
Ventilation	The INU/INUe requires unobstructed air passage to <i>each side</i> for ventilation purposes. There must be a minimum of 50 mm (2") of side spacing to any rack panels, cable bundles or similar. No space above or below is required for ventilation purposes.
Fan Air Filter	The fan air filter must be installed where the INU/INUe is required to be NEBS compliant. The filter must be inspected regularly and replaced when dust laden. Inspection must be at not more than 12 monthly intervals in controlled air environments, or more frequently otherwise.
Power Line Filter	The power line filter must be installed where the INU/INUe is required to be NEBS compliant.
Maximum Ambient Temperature	The INU/INUe is specified for a maximum ambient temperature (T _{mra}) of +45° Celsius (113° Fahrenheit). The maximum ambient temperature (T _{mra}) of +45° Celsius applies to the <i>immediate operating environment</i> of the INU, which if installed in a rack, is the ambient applying to its location within the rack.
Physical stability	Ensure that adding an INU/INUe to a rack does not adversely impact the physical stability of the rack.
Power supply -48 Vdc	<p>The INU (NCC and NPC) has the +ve pin on its dc power supply connector connected to the chassis.</p> <p>It must be used with a -48 Vdc power supply which has a +ve ground; the power supply ground conductor is the +ve supply to the INU.</p> <p>There must be no switching or disconnecting devices in the ground conductor between the dc power supply and the point of connection to an INU/INUe.</p> <p>For NEBS compliance the battery return connection is to be treated as a common DC return (DC-C), as defined in GR-1089-CORE.</p>

Function/Requirement	Details
Power Supply +24 Vdc	<p>A PCC is required to provide a +24 Vdc to -48 VDC conversion. The dc power supply supplying the PCC must be -ve grounded.</p> <p>There must be no switching or disconnecting devices in the ground conductor between the dc power supply and the point of connection to a PCC.</p>
Power Supply Location	<p>The INU/INUe must be installed in the same premises as its dc power supply and be located in the same immediate area (such as adjacent racks or cabinets) as any other equipment that is connected to the same dc power supply.</p>
Power Supply Compliance and Loading	<p>The dc power supply must be UL or IEC compliant for a SELV output (60 Vdc maximum).</p> <p>Check to ensure that connection of an Eclipse system to an existing dc supply does not overload the supply, circuit protection devices and wiring.</p> <p>Where a new dc power supply is to be installed for an Eclipse Node, the power supply should be rated to supply:</p> <ul style="list-style-type: none"> • 12.5 A for the INU • 25 A for the INUe • 15A for the PCC
Cable routing	<p>Eclipse tributary, auxiliary and NMS cables are not to be routed with any AC mains power lines. They are also to be kept away from any power lines which cross them.</p>
Grounding	<p>The INU must be grounded to the station or master ground, which must be the same ground as used for the dc power supply. Normally this is achieved by grounding the INU to the ground bar in its equipment rack or frame. This bar is most often located to one side of the rack or at rack top or bottom. In turn, the ground bar is grounded to the station ground.</p>
Intrabuilding interfaces and cabling (NEBS Compliance)	<p>Intrabuilding connections to/from Eclipse ports must only be connected via intrabuilding or unexposed wiring or cabling.</p> <p>Intrabuilding ports MUST NOT be metallically connected to interfaces that connect to the OSP or its wiring. These interfaces are designed for use as intrabuilding interfaces only (Type 2 or Type 4 ports as described in GR-1089-CORE, Issue 4) and require isolation from the exposed OSP cabling. The addition of Primary Protectors is not sufficient protection in order to connect these interfaces metallically to OSP wiring.</p> <p>Shielded and grounded cables must be used for intrabuilding cabling to/from Eclipse ports. Cables must be grounded at both ends.</p>

Plug-in Installation Requirements

The IDC has four universal slots and two dedicated slots. The IDCe has six universal slots, three restricted slots and 4 dedicated slots. A populated IDC/IDCe is called an INU/INUe.

Figure 6-7. Slot Numbering for INU and INUe

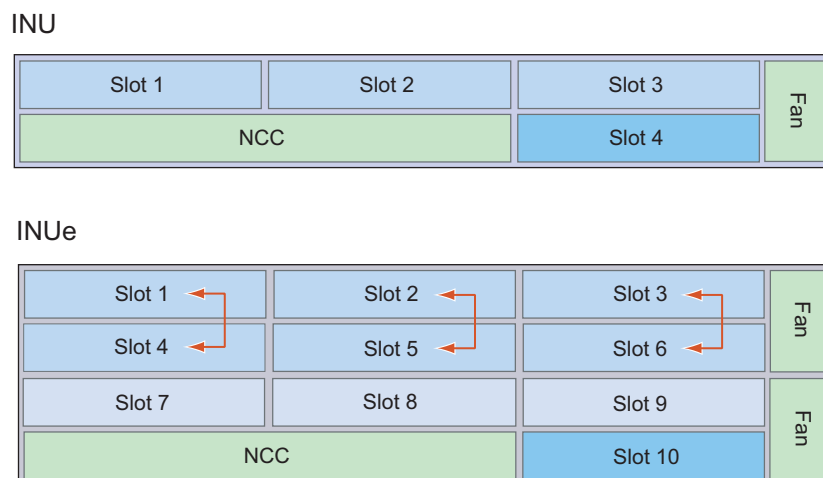









Installing or changing out a plug-in is a straightforward process. The requirements are detailed in [Table 6-2](#).

Unless specified by the customer, plug-ins will not be installed in an INU/INUe at shipment. Instead, each is individually packed within the shipping box.

Table 6-2. Plug-in Requirements

Function/Requirement	Priority	Details
Slot Assignment		
All slots filled		All slots must be filled with either a plug-in or a blanking panel. Failure to do so will compromise EMC integrity and distribution of FAN cooling air.
Universal slots 1-4 on an INU 1-6 on an INUe		RAC, DAC, and AUX plug-ins can be fitted in any universal slot.
Restricted slots 7-9 on an INUe		DAC, and AUX plug-ins can be fitted in any restricted slot. The exceptions are the DAC 155oM and AUX, which must only be installed in slots 1 to 6 <i>when they are to be configured to carry/access Eclipse NMS</i> , otherwise they can be installed in slots 7 to 9.
Dedicated slots		The NCC, FAN, and NPC plug-ins have dedicated slots.
Protected RACs INUe		Protected RACs (or ring-protected RAC with DAC 155oM) must only be installed in 'above and below' slots as indicated by the red arrows.
AUX		Multiple AUX plug-ins can be installed per INU/INUe.

Function/Requirement	Priority	Details
NPC		Only one NPC is required to provide the NCC protection option. An NPC must be installed in slot 4 of an INU, or slot 10 of an INUe. If an NPC is not installed in an INU, slot 4 is available as a universal slot.
Installing / Changing Plug-ins		
ESD grounding strap	 CAUTION	Always connect yourself to the INU/INUe with an ESD grounding strap before changing or removing a plug-in. Failure to do so can cause ESD damage to the plug-ins. Avoid hand contact with the PCB top and bottom.
Finger-grip fasteners	 CAUTION	Plug-ins must be withdrawn and inserted using their finger-grip fasteners/pulls. Never withdraw or insert using attached cables, as damage to the plug-in connector and its PCB attachment can occur. If not complied with, the Aviat Networks warranty may be voided.
Hot-swappable	 CAUTION	Plug-ins are hot-swappable. <ul style="list-style-type: none"> • Removal of an in-service payload plug-in will interrupt its traffic. • Removal of the NCC will affect all traffic - unless protected by an NPC. • Removal / replacement of the FAN does not affect traffic.
Engaging backplane connector		When installing a plug-in, ensure its backplane connector is correctly engaged before applying sufficient pressure to bring the plug-in panel flush with the front panel.
Revision time lag		When swapping or installing plug-ins, up to 60 seconds can be required for the INU/INUe to show its revised status via the front panel LEDs, or via Portal.
EMC integrity	 CAUTION	Plug-ins and blanking panels are held in place by captive finger-screws. Ensure the finger-screws are fastened as failure to do so may compromise EMC integrity and fan cooling.
RACs		
Connecting and disconnecting the RFU cable at the RAC	 CAUTION	Never disconnect or reconnect an RFU cable to a RAC without first turning the power off to the INU or withdrawing the RAC from the backplane. <p>Note: The RFU cable provides the power feed to the IRU 600. Arcing during connection and disconnection at the RAC on a live RAC can cause damage to connector contact surfaces. Power spikes caused by live connection and disconnection may also cause errors on other traffic passing through the INU/INUe. The only exception to live disconnection and connection should be for checks of protected operation at link commissioning.</p>
Removing RAC from a powered INU	 CAUTION	When removing a RAC from a powered INU, always the disengage the RAC from the backplane before disconnecting its RFU cable. Similarly before inserting an RAC, always reconnect the RFU cable before engaging the backplane.

Function/Requirement	Priority	Details
RAC combinations for INUe		<p>An INUe can be fitted with a maximum of:</p> <ul style="list-style-type: none"> • Five RAC 60s. • Four RAC 6Xs. <p>(The reduced RAC numbers are to ensure temperature limits within the INUe are not exceeded at high ambients. See Node Card Maximums.)</p>
DACs		
DAC combinations		DACs can be fitted singly or in combination to provide a mix of interface types and capacities provided they have a common backplane configuration. The backplane can be set for 1.5 Mbps/DS1, 43 Mbps/DS3, or 155 Mbps/OC3. TDM Mux DACs allow a mix of interfaces from a common DS1 backplane configuration.
Increasing node capacity		To achieve a greater node capacity, two or more INUs can be interconnected via a DAC option.
DAC 16x Mini RJ-21 trib cable connector		<p>Ensure correct orientation of the Mini RJ-21 connector on DAC 16x before pushing it home. This can be checked by the scalloped key to one side of the connector. Additionally, a trib cable supplied by Aviat Networks will have the cable exiting to the right side when viewed from the front.</p> <p>Ensure the connector retaining screws are not over-tightened - only use light/moderate screwdriver pressure.</p>
Line Protection (electrical DACs)		Line (interface) protection can be provided for paired DS3 and STS3 electrical DACs.
Line Protection (optical DACs)		Line (interface) protection can be provided for paired OC3 optical DACs.
General		
Maximum Backplane Capacity of Eclipse Node		<p>The maximum drop, through plus drop, or through backplane capacity on an Eclipse Node is one of the following, depending on the backplane setting:</p> <ul style="list-style-type: none"> • 300 Mbps • 128xDS1 • 6xDS3 • 2xOC3
Antistatic bags		Enclose spare plug-ins, or plug-ins to be returned for service, in an antistatic bag. When handling a plug-in to or from an antistatic bag, do so at the INU/INUe and only when you are connected to the INU/INUe via an ESD ground strap.
Spare blank panels		Keep any removed blanking panels for future use.

Installing an INU

Procedure

1. Fit the rack mounting ears to the chassis with the grounding stud to left or right side for the most direct ground wire path to the rack ground bar.
2. Locate the INU/INUe in the equipment rack and secure it using four No.12 Phillips dome-head screws from the IDC installation kit.
3. Where NEBS compliance is required, install the power line filter unit. Install immediately below or above the INU. Separate filter units are required for the NCC and, where fitted, the NPC. Use the supplied 2w2 to 2w2 cable to connect the output of the filter unit to the input of the NCC or NPC.
4. Ground the INU/INUe from the grounding stud to the rack/frame ground bar using a length of 4 mm² (AWG 12) green PVC insulated stranded copper wire with a suitably sized ground lug at each end (supplied by the installer).
 - For NEBS compliance, 16 mm² (AWG 6) green PVC insulated stranded copper wire is required together with a star washer under the grounding screw. Torque the INU grounding post screw to 1.2-1.5 Nm (10-13 in-lbs).
5. If the equipment rack/frame requires grounding, use 16 mm² (AWG 6) wire from its ground bar to the station ground.



Do not assume that an existing rack or mounting frame is correctly grounded. Always check the integrity of the ground connections, which must include a check through to the master ground for the station, which should be located at the point of cable entry to the equipment building.



For **NEBS compliance**:

- All bare conductors must be coated with an appropriate antioxidant compound before crimp connectors are fitted.
 - All unplated connectors, braided strap, and bus bars must be brought to a bright finish and then coated with an antioxidant before they are connected. This does not apply to tinned, solder-plated, or silver-plated connectors and other plated connection surfaces – but all must be clean and free of contaminants.
 - All raceway fittings must be tightened to provide a permanent low-impedance path.
-

6. Install the plug-ins in their assigned slot positions, and check that their front panels are flush-fitted (not protruding) and held secure by their fasteners. Ensure unused slots are covered by blanking panels. Refer to .

Where a fan air filter is to be installed, install it prior to installing the FAN plug-in.

7. Install the CompactFlash card in the NCC plug-in; withdraw the NCC and insert in the socket on the right side of the PCB.
8. Fit the IF cable between the RAC(s) and IRU 600 RFU(s). IF cables are supplied with the IRU 600.

Fit the DAC tributary cables.



For a DAC 16x, ensure correct orientation of the Mini RJ-21 connector before pushing it home. This can be checked by the scalloped key to one side of the connector. Additionally, a trib cable supplied by Aviat Networks will have the cable exiting to the right side when viewed from the front.

Do NOT over-tighten the Mini RJ-21 retaining screws.

The following steps describe the procedure for preparing the power cable, and preparing for power-on. **Do not connect the power until all steps have been completed.**

9. Run the supplied power cable through to the power pick up point, which will normally be at a circuit breaker panel in the rack. A circuit breaker (or fuse) should have a capacity of 12 A for the INU and 25 A for the INUe.
10. For a -48 Vdc supply, connect the blue wire to -48 Vdc (live), and the black wire to ground/+ve. (Power input on the NCC and NPC is polarity protected).
11. For a +24 Vdc supply, connect the blue wire to +24 Vdc (live), and the black wire to ground/-ve. (Power input on the PCC is polarity protected).
12. Measure the voltage on the dc power connector.
 - For -48 Vdc operation the voltage should be -48 Vdc, +/- 2 Vdc for a non battery floated supply, and nominally -56 Vdc for a battery floated supply. (Limits are -40.5 to - 60 Vdc).
 - For +24 Vdc operation the voltage should be 24 +/- 2 Vdc for a non battery floated supply, and nominally 30 Vdc for a battery floated supply. (Operating limits are 20 to 36 Vdc).



This product meets the global product safety requirements for SELV (safety extra-low voltage) rated equipment and the input voltage must be guaranteed to remain within the SELV limits (60 V maximum) in the event of a single internal fault.

Always check the integrity of the dc power supply to an INU/INUe *right to its source*. Never assume that the supply provided to the pick-up point in a rack is correct.

Eclipse dc power, IF, tributary, auxiliary and NMS cables are not to be routed with any AC mains power lines. They are also to be kept away from any AC power lines which cross them.

13. Carry out a complete check of the installation. If all is correct, and the IRU 600 and its waveguide, pressurization and antenna installation has likewise been completed and checked, Eclipse is now ready for power-on. **If a PCC is installed, ensure the PCC to NCC/NPC cable is fitted before power-on.**



Once powered up the RFU(s) will be transmitting with the pre-configured or ex-factory frequency and power settings unless the start-up transmit mute option has been invoked. (All RFUs shipped ex-factory have the transmit-mute set as the default unless otherwise specified).

If frequency and power settings are not correct, interference can be caused to other links in the same geographical area.

14. Power on for -48 Vdc by connecting the power cable to the NCC, and to the NPC where fitted.
 - For +24 Vdc operation, connect to the PCC input.
 - Where a power line filter is installed (for -48 Vdc), connect to the filter input.



The 2W2 DC power connector can be shorted inadvertently if applied at an angle. Always insert with correct alignment.

Next step: The Eclipse node is ready for configuration and antenna alignment.

260-668066-003

WWW.AVIATNETWORKS.COM