

Pasadena Blue Line

Metro Radio System

Maintenance Handbook
For

Canam Technology Inc.

AFL Works Order Nō.: Q109394

AFL product part Nō.: **60-056104** **800MHz BDA**

| | | | |
|---|---|-------------|--|
|  Aerial Facilities Limited www.AerialFacilities.com Technical Literature | 800MHz BDA (Pasadena Figuero Tunnel) Maintenance Handbook | | |
| | H/book Number:- 60-056100HBKM | Issue No:-1 | Date:- 21/10/2003 Page:-1 of 52 |

Table of Contents

| | |
|---|-----------|
| <u>AMENDMENT LIST RECORD SHEET</u> | 4 |
| <u>INTRODUCTION</u> | 5 |
| <u>Scope</u> | 5 |
| <u>Purpose</u> | 5 |
| <u>Glossary of Terms</u> | 6 |
| <u>AFL Drawing Symbol Keys</u> | 7 |
| 1. <u>SAFETY CONSIDERATIONS</u> | 8 |
| 1.1 <u>Electric Shock Hazard</u> | 8 |
| 1.2 <u>RF Radiation Hazard</u> | 8 |
| 1.3 <u>Chemical Hazard</u> | 9 |
| 1.4 <u>Emergency Contact Numbers</u> | 9 |
| 2. <u>OVERVIEW/SYSTEM DESCRIPTION</u> | 10 |
| 3. <u>SPECIFICATIONS</u> | 11 |
| 3.1 <u>800MHz Channelised BDA 60-056104 Parts Lists</u> | 11 |
| 3.2 <u>Technical Specifications</u> | 13 |
| 3.2.5 <u>800MHz 8 Channel Channelised BDA Technical Specification</u> | 13 |
| 3.3 <u>Mechanical Specification</u> | 14 |
| 3.3.1 <u>800MHz BDA Wall Mount Case</u> | 14 |
| 4. <u>SYSTEM DRAWINGS</u> | 15 |
| 4.1 <u>Drg. Nō. 60-056194, 800MHz BDA Case Outline Drawing</u> | 15 |
| 4.2 <u>800MHz Channelised PBL BDA System Diagram</u> | 16 |
| 5. <u>SUB-UNIT MODULES</u> | 17 |
| 5.1 <u>Bandpass Filter (02-011601)</u> | 17 |
| 5.1.1 <u>Description</u> | 17 |
| 5.1.2 <u>Technical Specification</u> | 17 |
| 5.2 <u>2-Way Splitter/Combiner (05-002602)</u> | 18 |
| 5.2.1 <u>Description</u> | 18 |
| 5.2.2 <u>Technical Specification</u> | 18 |
| 5.3 <u>4-Way Splitter/Combiner (05-003302)</u> | 19 |
| 5.3.1 <u>Description</u> | 19 |
| 5.3.2 <u>Technical Specification</u> | 19 |
| 5.4 <u>¼Watt 0- -30dB Switched Attenuator (10-000701)</u> | 19 |
| 5.4.1 <u>General Application</u> | 19 |
| 5.4.2 <u>Switched Attenuators</u> | 19 |
| 5.5 <u>Low Noise Amplifiers (11-005902 & 11-006702)</u> | 20 |
| 5.5.1 <u>Description</u> | 20 |
| 5.5.2 <u>Technical Specification (11-005902)</u> | 20 |
| 5.5.3 <u>Drg. Nō. 11-005902 LNA General Assembly Drawing</u> | 21 |
| 5.5.4 <u>Drg. Nō. 11-005970, LNA Circuit Diagram (RF)</u> | 22 |
| 5.5.5 <u>Drg. Nō. 11-005971, LNA Circuit Diagram (DC Wiring Layout)</u> | 23 |
| 5.5.6 <u>Technical Specification (11-006702)</u> | 24 |
| 5.5.7 <u>Drg. Nō. 11-006702, LNA General Assembly Drawing</u> | 25 |
| 5.5.8 <u>Drg. Nō. 11-006770, LNA Circuit Diagram (RF Components)</u> | 26 |
| 5.5.9 <u>Drg. Nō. 11-006771, LNA DC Wiring Diagram</u> | 27 |
| 5.6 <u>10Watt Power Amplifier (12-002105)</u> | 28 |
| 5.6.1 <u>Description</u> | 28 |
| 5.6.2 <u>Technical Specification</u> | 28 |
| 5.6.3 <u>Drg. Nō. 12-002105, 10W PA Assembly Drawing</u> | 29 |
| 5.6.4 <u>Drg. Nō. 12-001275, 10W PA Circuit Diagram</u> | 30 |
| 5.6.5 <u>Drg. Nō. 12-002175C12, PA Parts List(1)</u> | 31 |
| 5.6.6 <u>Drg. Nō. 12-002175C2, PA Parts List(2)</u> | 32 |

| | | |
|-------------------|--|-----------|
| 5.6.7 | Drg. Nõ. 80-008450, PA Alarm Wiring Details | 33 |
| 5.7 | 3 Stage Alarm Board (12-002201) | 34 |
| 5.7.1 | Description | 34 |
| 5.7.2 | Technical Specification | 35 |
| 5.7.3 | Drg. Nõ. 12-002201, 3 Stage Alarm Board Assembly Drawing & Parts List | 36 |
| 5.7.4 | Drg. Nõ. 12-002270, 3 Stage Alarm Board Circuit Diagram | 37 |
| 5.7.5 | Generic Wall Enclosure Alarm Wiring Sketch | 38 |
| 5.8 | DC/DC Converter, 24V in, 12V 8A out (13-003011) | 39 |
| 5.8.1 | Description | 39 |
| 5.8.2 | Technical Specification | 39 |
| 5.8.3 | Photo of Regulator PCB (regulator heatsink side) | 39 |
| 5.9 | Channel Control & Channel Selective Modules (17-002101 & 17-009127) | 40 |
| 5.9.1 | Channel Selective Module Description | 40 |
| 5.9.2 | Drg. Nõ. 17-003080, Generic Channel Module Block Diagram | 41 |
| 5.9.3 | Channel Control Module Description | 42 |
| 5.9.4 | Channel Controller Frequencies | 42 |
| 5.9.5 | Channel Frequency Control Switch Table | 43 |
| 5.10 | 24V Single Relay Board (80-008902) | 43 |
| 5.10.1 | Description | 43 |
| 5.11 | 24V 400W Flat-Pack Power Supply (96-300011) | 44 |
| 5.11.1 | Description | 44 |
| 5.11.2 | Technical Specification | 44 |
| 6. | INSTALLATION | 45 |
| 6.1 | Initial Installation Record | 45 |
| 6.2 | General | 45 |
| 6.3 | Electrical Connections | 45 |
| 6.4 | RF Connections | 45 |
| 6.5 | Commissioning | 46 |
| 7. | MAINTENANCE | 47 |
| 7.1 | General Procedures | 47 |
| 7.1.1 | Fault Finding | 47 |
| 7.1.2 | Downlink | 48 |
| 7.1.3 | Uplink | 48 |
| 7.1.4 | Fault repair | 48 |
| 7.1.5 | Checking service | 49 |
| 7.1.6 | Service Support | 49 |
| 7.2 | Tools & Test Equipment | 49 |
| 7.3 | Care of Modules | 50 |
| 7.3.1 | General Comments | 50 |
| 7.3.2 | Module Removal (LNA's, general procedure): | 50 |
| 7.3.3 | Module Replacement (general): | 50 |
| 7.3.4 | Power Amplifiers | 50 |
| 7.3.5 | Low Power Amplifier Replacement | 51 |
| 7.3.6 | Module Transportation: | 51 |
| APPENDIX A | INITIAL EQUIPMENT SET-UP CALCULATIONS | 52 |

INTRODUCTION

Scope

This handbook is for use solely with the equipment identified by the AFL Part Number shown on the front cover. It is not to be used with any other equipment unless specifically authorised by Aerial Facilities Limited. This is a controlled release document and, as such, becomes a part of Aerial Facilities' Total Quality Management System. Alterations and modification may therefore only be performed by Aerial Facilities Ltd.

Purpose

The purpose of this handbook is to provide the user/maintainer with sufficient information to service and repair the equipment to the level agreed. Maintenance and adjustments to any deeper level must be performed by AFL, normally at the company's repair facility in Chesham, England.

This handbook has been prepared in accordance with BS 4884, and AFL's Quality procedures, which maintain the company's registration to ISO 9001: 1994 and to the R&TTE Directive of the European Parliament. Copies of the relevant certificates and the company Quality Manual can be supplied on application to the Quality Manager. This document fulfils the relevant requirements of Article 6 of the R&TTE Directive.

Limitation of Information Notice

This manual is written for the use of technically competent operators/service persons. No liability is accepted by AFL for use or misuse of this manual, the information contained therein, or the consequences of any actions resulting from the use of the said information, including, but not limited to, descriptive, procedural, typographical, arithmetical, or listing errors.

Furthermore, AFL does not warrant the absolute accuracy of the information contained within this manual, or its completeness, fitness for purpose, or scope.

AFL has a policy of continuous product development and enhancement, and as such, reserves the right to amend, alter, update and generally change the contents, appearance and pertinence of this document without notice.

All AFL products carry a twelve month warranty from date of shipment. The warranty is expressly on a return to base repair or exchange basis and the warranty cover does not extend to on-site repair or complete unit exchange.

| | | | |
|---|---|-------------|--------------------------|
|  Aerial Facilities Limited www.AerialFacilities.com Technical Literature | 800MHz BDA (Pasadena Figuero Tunnel) Maintenance Handbook | | |
| | H/book Number:- 60-056100HBKM | Issue No:-1 | Date:- 21/10/2003 |

Glossary of Terms

| | |
|-----------------------------------|--|
| Repeater or Cell Enhancer | A Radio Frequency (RF) amplifier which can simultaneously amplify and re-broadcast Mobile Station (MS) and Base Transceiver Station (BTS) signals. |
| Band Selective Repeater | A Cell Enhancer designed for operation on a range of channels within a specified frequency band. |
| Channel Selective Repeater | A Cell Enhancer, designed for operation on specified channel(s) within a specified frequency band. Channel frequencies may be factory set or on-site programmable. |
| BTS | Base Transceiver Station |
| C/NR | Carrier-to-Noise Ratio |
| Downlink (D.L.) | RF signals transmitted from the BTS and to the MS |
| Uplink (U.L.) | RF signals transmitted from the MS to the BTS |
| EMC | Electromagnetic Compatibility |
| GND | Ground |
| DC | Direct Current |
| AC | Alternating Current |
| ID | Identification Number |
| OIP3 | Output Third Order Intercept Point = $RF_{out} + (C/I)/2$ |
| LED | Light Emitting Diode |
| M.S. | Mobile Station |
| N/A | Not Applicable |
| N/C | No Connection |
| NF | Noise Figure |
| RF | Radio Frequency |
| Rx | Receiver |
| Tx | Transmitter |
| S/N | Serial Number |

AFL Drawing Symbol Keys

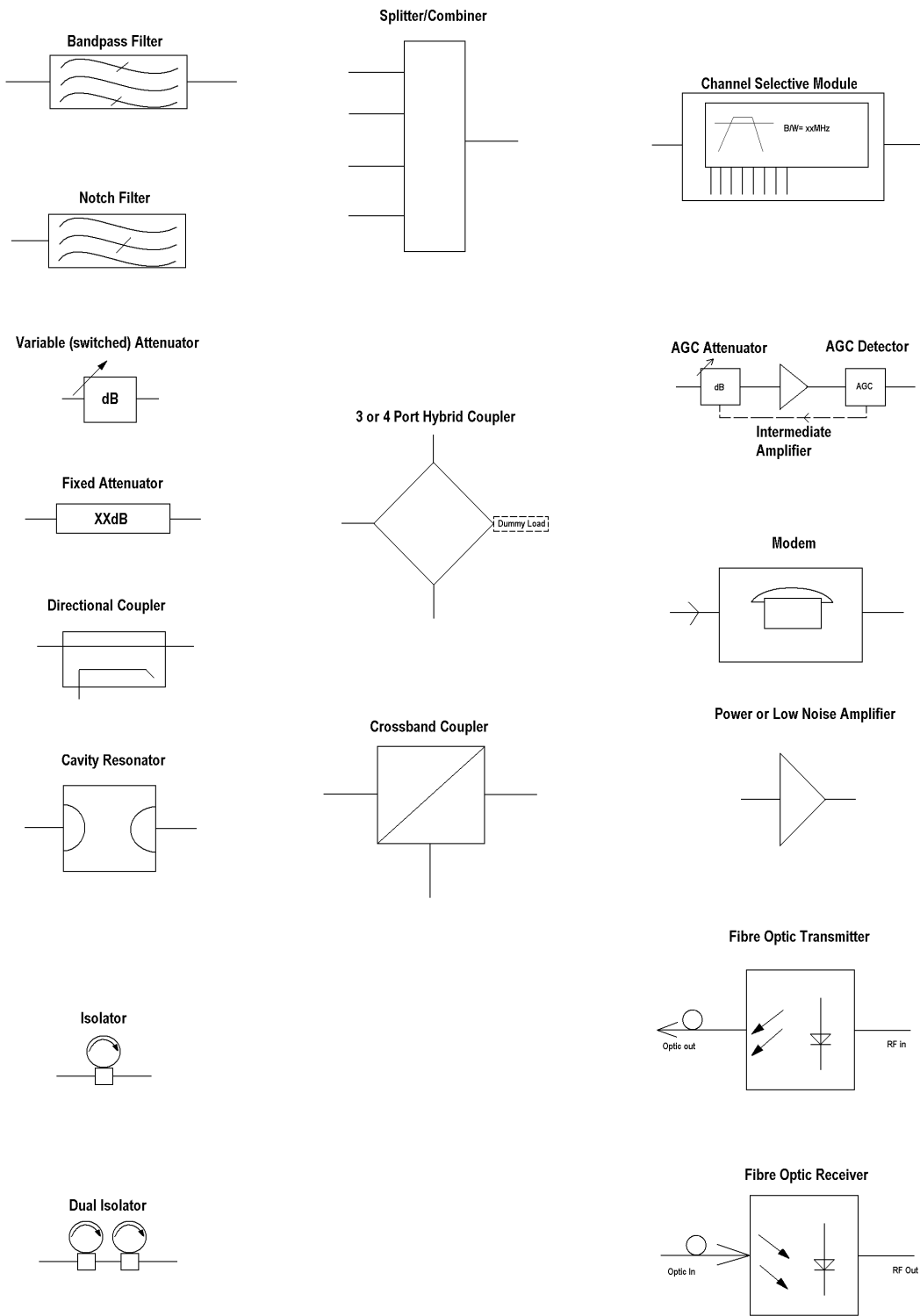

Key to AFL RF Modules

| | | | |
|--|--|-------------------------|----------------------|
|  <p>Aerial Facilities Limited www.AerialFacilities.com Technical Literature</p> | <p align="center">800MHz BDA (Pasadena Figuero Tunnel) Maintenance Handbook</p> | | |
| <p>H/book Number:-60-056100HBKM</p> | <p>Issue No:-1</p> | <p>Date:-21/10/2003</p> | <p>Page:-7 of 52</p> |

1. SAFETY CONSIDERATIONS

1.1 Electric Shock Hazard

Electrical shocks due to faulty mains driven power supplies.

Whilst ever potentially present in any electrical equipment, such a condition would be minimised by quality installation practice and thorough testing at:

- a) Original assembly.
- b) Commissioning.
- c) Regular intervals, thereafter.

All test equipment to be in good working order prior to its use. High current power supplies can be dangerous because of the possibility of substantial arcing. Always switch off during disconnection and reconnection.

1.2 RF Radiation Hazard

“CAUTION: This equipment is approved for antennas mounted on fixed outdoor permanent structures. A minimum separation distance of 2 metres must be maintained between the radiating elements and any nearby persons. A maximum antenna gain of 21 dBi may be used. Operating this equipment without regard to these restrictions will result in RF exposure levels above the limits allowed by FCC rules.”

This equipment complies with part 90 of the FCC rules. Any changes or modifications not expressly approved by the manufacturer could void the user’s authority to operate the equipment.

RF radiation, (especially at UHF frequencies) arising from transmitter outputs connected to AFL’s equipment, must be considered a safety hazard.

This condition might only occur in the event of cable disconnection, or because a ‘spare’ output has been left unterminated. Either of these conditions would impair the system’s efficiency. No investigation should be carried out until all RF power sources have been removed. This would always be a wise precaution, despite the severe mismatch between the impedance of an N type connector at 50Ω, and that of free space at 377Ω, which would severely mitigate against the efficient radiation of RF power. Radio frequency burns could also be a hazard, if any RF power carrying components were to be carelessly touched!

Antenna positions should be chosen to comply with requirements (both local & statutory) regarding exposure of personnel to RF radiation. When connected to an antenna, the unit is capable of producing RF field strengths, which may exceed guideline safe values especially if used with antennas having appreciable gain. In this regard the use of directional antennas with backscreens and a strict site rule that personnel must remain behind the screen while the RF power is on, is strongly recommended.

Where the equipment is used near power lines, or in association with temporary masts not having lightning protection, the use of a safety earth connected to the case-earthing bolt is strongly advised.

| | | | |
|---|---|---------------|------------------|
|  Aerial Facilities Limited www.AerialFacilities.com Technical Literature | 800MHz BDA (Pasadena Figuero Tunnel) Maintenance Handbook | | |
| | H/book Number:-60-056100HBKM | Issue No:-1 | Date:-21/10/2003 |
| | | Page:-8 of 52 | |

1.3 Chemical Hazard



Beryllium Oxide, also known as Beryllium Monoxide, or Thermalox™, is sometimes used in devices within equipment produced by Aerial Facilities Ltd. Beryllium oxide dust can be toxic if inhaled, leading to chronic respiratory problems. It is harmless if ingested or by contact.

Products that contain beryllium are load terminations (dummy loads) and some power amplifiers. These products can be identified by a yellow and black “skull and crossbones” danger symbol (shown above). They are marked as hazardous in line with international regulations, but pose no threat under normal circumstances. Only if a component containing beryllium oxide has suffered catastrophic failure, or exploded, will there be any danger of the formation of dust. Any dust that has been created will be contained within the equipment module as long as the module remains sealed. For this reason, any module carrying the yellow and black danger sign should not be opened. If the equipment is suspected of failure, or is at the end of its life-cycle, it must be returned to Aerial Facilities Ltd for disposal.

To return such equipment, please contact the Quality Department, who will give you a Returned Materials Authorisation (RMA) number. Please quote this number on the packing documents, and on all correspondence relating to the shipment.

PolyTetraFluoroEthylene, (P.T.F.E.) and P.T.F.E. Composite Materials

Many modules/components in AFL equipment contain P.T.F.E. as part of the RF insulation barrier.

This material should never be heated to the point where smoke or fumes are evolved. Any person feeling drowsy after coming into contact with P.T.F.E. especially dust or fumes should seek medical attention.

1.4 Emergency Contact Numbers

The AFL Quality Department can be contacted on:

Telephone +44 (0)1494 777000
Fax +44 (0)1494 777002
e-mail qa@aerial.co.uk

| | | | |
|---|---|-------------|------------------|
|  Aerial Facilities Limited www.AerialFacilities.com Technical Literature | 800MHz BDA (Pasadena Figuero Tunnel) Maintenance Handbook | | |
| | H/book Number:-60-056100HBKM | Issue No:-1 | Date:-21/10/2003 |
| | | | Page:-9 of 52 |

2. OVERVIEW/SYSTEM DESCRIPTION

The AFL 800MHz Off Air Amplifier for the Pasadena Blue line project is an 8 way channelised RF amplifier. It's application is as an air interface between the donor radio site and the tunnel leaky feeder system. The unit is housed in an environmentally protected IP65 steel wall-mount case. Handles are provided for carrying the unit and the door is fitted with locks. The unit interfaces with 'N' type female connectors for RF connections and heavy duty connectors for routing of AC power supply input and alarm output wiring.

The unit is housed in an environmentally protected IP65 steel wall-mount case. Handles are provided for carrying the unit and the door is fitted with locks. The unit interfaces with 'N' type female connectors for RF connections and heavy duty connectors for routing of AC power supply input and alarm output wiring.

To provide adequate selectivity in the Downlink and Uplink paths, combine design duplexers are used at the input and output ports. To provide the required gain to reach the required signal levels, low-noise amplifiers (LNA's) are used in each path, these being followed by power amplifier modules to provide the required intermodulation performance. Gain adjustment is available locally using switched attenuators.

Note that "Downlink" refers to the RF path from FO receiver to the leaky feeder port and that "Uplink" refers to the RF path from the leaky feeder port to the FO transmitter.

| | | | |
|---|---|-------------|--------------------------|
|  Aerial Facilities Limited www.AerialFacilities.com Technical Literature | 800MHz BDA (Pasadena Figuero Tunnel) Maintenance Handbook | | |
| | H/book Number:- 60-056100HBKM | Issue No:-1 | Date:- 21/10/2003 |

3. SPECIFICATIONS

3.1 800MHz Channelised BDA 60-056104 Parts Lists

| | | |
|-----------|--|----|
| 02-011601 | 900MHz 8POLE 7.5MHz B/W SMA | 4 |
| 05-002602 | 900MHz SPLITTER/COMBINER, 20W | 4 |
| 05-003302 | 4 WAY SPLITTER GSM 900MHz | 8 |
| 10-000701 | 1/4W0-30dB SWITCHED ATTENUATOR | 4 |
| 11-005902 | 900MHz LOW NOISE AMP WITH RELAY ASS | 3 |
| 11-006702 | GA 800-1000MHz LNA 29dB (WITH RELAY) | 2 |
| 12-002105 | 900MHz 10W PA 24V 2.8A (ALARMS) | 2 |
| 12-002201 | 3 STAGE AMPLIFIER ALARM BOARD | 2 |
| 12-002220 | 3 STAGE ALARM PCB COVER | 2 |
| 12-002826 | ALARM BOARD ACRYLIC LENS | 2 |
| 13-003011 | DC/DC CONVERTER 24-12V 8A PCB SUB-ASS | 2 |
| 13-003020 | DC-DC CONVTR 24-12V HEATSINK | 2 |
| 17-000126 | CELL ENHANCER LABEL 6 DIGIT | 1 |
| 17-001522 | BASE PLATE 560 x 345mm 17-001520&9020 | 1 |
| 17-002101 | CHANNEL CONTROL MODULE | 4 |
| 17-002103 | 26WAY RIBBON CABLE LEAD | 0 |
| 17-003022 | MODULE PATTERNED LEAVE | 16 |
| 17-003023 | SUBRACK SIDE PANEL | 8 |
| 17-003024 | SUBRACK REAR BRACKET | 16 |
| 17-003025 | BOTTOM MODULE GUIDE | 16 |
| 17-003028 | MODULE SQUARE LEAVE | 16 |
| 17-003029 | TOP MODULE GUIDE | 16 |
| 17-009026 | C/E 820 x 620 x 250(3 HEATSINKS)2.0 CASE | 1 |
| 17-009127 | CHAN MOD 810-860MHz 30KHz 8p TCXO | 16 |
| 17-009723 | EQUIP. MTG PLATE No.4 | 4 |
| 17-009725 | EQUIP. MTG PLATE No.6 | 2 |
| 80-008902 | 24V RELAY PCB ASSEMBLY | 1 |
| 80-032320 | 10W PA HEATSINK (NEEDS 17-000526) | 2 |
| 80-032322 | 10W PSU HEATSINK (NEEDS 17-000526) | 1 |
| 90-010021 | RF CABLE SUPFLEX SMA R/A MALE 100mm | 5 |
| 90-010022 | RF CABLE SUPFLEX SMA R/A MALE 200mm | 3 |
| 90-010026 | RF CABLE HIFLEX SMA R/A MALE 150mm | 4 |
| 90-010028 | RF CABLE HIFLEX SMA R/A MALE 350mm | 1 |
| 90-010029 | RF CABLE HIFLEX SMA R/A MALE 450mm | 1 |
| 90-010131 | RF CABLE SMA R/A-N PANEL JACK 200mm | 1 |
| 90-010135 | RF CABLE SMA R/A-N PANEL JACK 500mm | 1 |
| 91-500011 | PWR 3POLE PNL PLUG SEALED IP68 | 2 |
| 91-500015 | PWR CON CAP SEALED with INT. THREAD | 2 |
| 91-500016 | PWR 6POLE PNL PLUG SEALED IP68 | 1 |
| 91-510010 | PWR 3POLE FREE SOC.SEALED IP68 | 1 |

| | | |
|-----------|-------------------------------------|---|
| 91-510013 | PWR CON CAP SEALED with Ext. THREAD | 2 |
| 91-510014 | PWR 6POLE FREE SOC.SEALED IP68 | 1 |
| 91-600014 | 'D' 9 WAY SOCKET S/B (NON FILTERED) | 6 |
| 91-620002 | 'D' 25 WAY SOCKET/IDC TERMS | 4 |
| 91-640003 | MISC 26 WAY RIBBON CABLE SOCK. | 4 |
| 91-700017 | ICD 15 WAY 0.1' CONNECTOR | 3 |
| 92-280033 | Captive Screw | 8 |
| 92-400017 | GASKET FOR N TYPE CONNECTOR | 3 |
| 93-540035 | 1K3 0.25W 1% RES MRS25 M:F | 2 |
| 96-300011 | 24 V 400 W FLATPACK PWR SUPPLY | 1 |
| 96-500003 | AC FILTER 110V 5A | 1 |
| 96-500005 | DC INPUT FILTERS | 1 |
| 96-700002 | LED.GREEN 5mm SEALED IP66 | 1 |
| 96-700005 | LED.RED 5mm SEALED IP66 | 1 |
| 96-900018 | AC TRIP SWITCH (5 AMP M.C.B.) | 1 |
| 96-920011 | PROXIMITY SWITCH | 1 |
| 96-920012 | PROXIMITY SWITCH MAGNET | 1 |
| 97-000002 | BLACK MODULE CAGE RUNNER | 8 |
| 97-300010 | SUPPLY I/P COVERS | 1 |
| 97-400010 | BLACK PLASTIC HANDLE 37311 | 2 |
| 97-600001 | SUBRACK FRONT HORIZ | 2 |
| 97-600002 | SUBRACK M2.5 STD TAP | 8 |
| 97-900004 | RUBBER FOOT FOR CELL ENHANCERS | 4 |

3.2 Technical Specifications

3.2.5 800MHz 8 Channel Channelised BDA Technical Specification

| | | |
|---------------------------|---|--------------------------|
| Frequency Range: | Downlink 857.0-861.0MHz | Uplink 812.0-816.0MHz |
| Band Width: | Downlink: 25kHz Uplink: 25kHz | |
| No. of Paths: | 2 | |
| No. of RF Ports: | 2 | |
| No. of Fibre Connections: | N/A | |
| RF Connector: | N type female | |
| RF Impedance: | 50Ω | |
| VSWR: | Better than 1.5:1 | |
| Downlink Gain: | 95 dB min | |
| Uplink Gain: | 95 dB min | |
| Gain Adjustment: | 0 to 30 in 2dB steps | |
| Downlink PA: | 10W Class A Linear | |
| Downlink Power: | 8 Carriers at +17dBm | |
| Uplink PA: | 10W Class A Linear | |
| Uplink Power: | 8 Carriers at +17dBm | |
| Duplexer UP/DN Isolation: | >80 dB | |
| Passband Ripple: | <±1.5 dB | |
| Noise Figure: | Uplink <6 dB at maximum gain Downlink <5 dB at maximum gain | |
| In-Band Spurious: | Better than -36dBm downlink Better than -36dBm uplink (measure with 30KHz BW with max gain setting) | |
| MTBF: | >50,000 hours | |
| Supply Input Voltage: | 110V AC | |
| Alarms Fitted: | Alarm: Volts free contacts (Amps, PSU, door) Alarm indicator- Red LED Power Indicator-Green LED | |

3.3 Mechanical Specification

3.3.1 800MHz BDA Wall Mount Case

| | | |
|---|---|-----------------------------|
| Size: | height: | 820 mm |
| | width: | 620 mm |
| | depth: | 250 mm |
| (excluding connectors, heatsinks, handles and feet) | | |
| Fixings: | 4 holes on 700 mm (h) x 667 mm (w) | |
| Weight: | 50 kg (approx.) | |
| Temperature Range: | operational: | -20°C to +50°C |
| | storage: | -40°C to +70°C |
| Humidity: | 10% to 95% non-condensing | |
| Environmental Protection: | IP65 (with door closed and all ports terminated) | |
| Finish: | Case: | RAL 7032 |
| | Heatsinks: | Black anodised |
| | Handles: | Black (where fitted) |
| Supply Cable: | Unit supplied with 3-pin IP68 connector for customer interface with AC input. | |

4. SYSTEM DRAWINGS

4.1 Drg. No. 60-056194, 800MHz BDA Case Outline Drawing

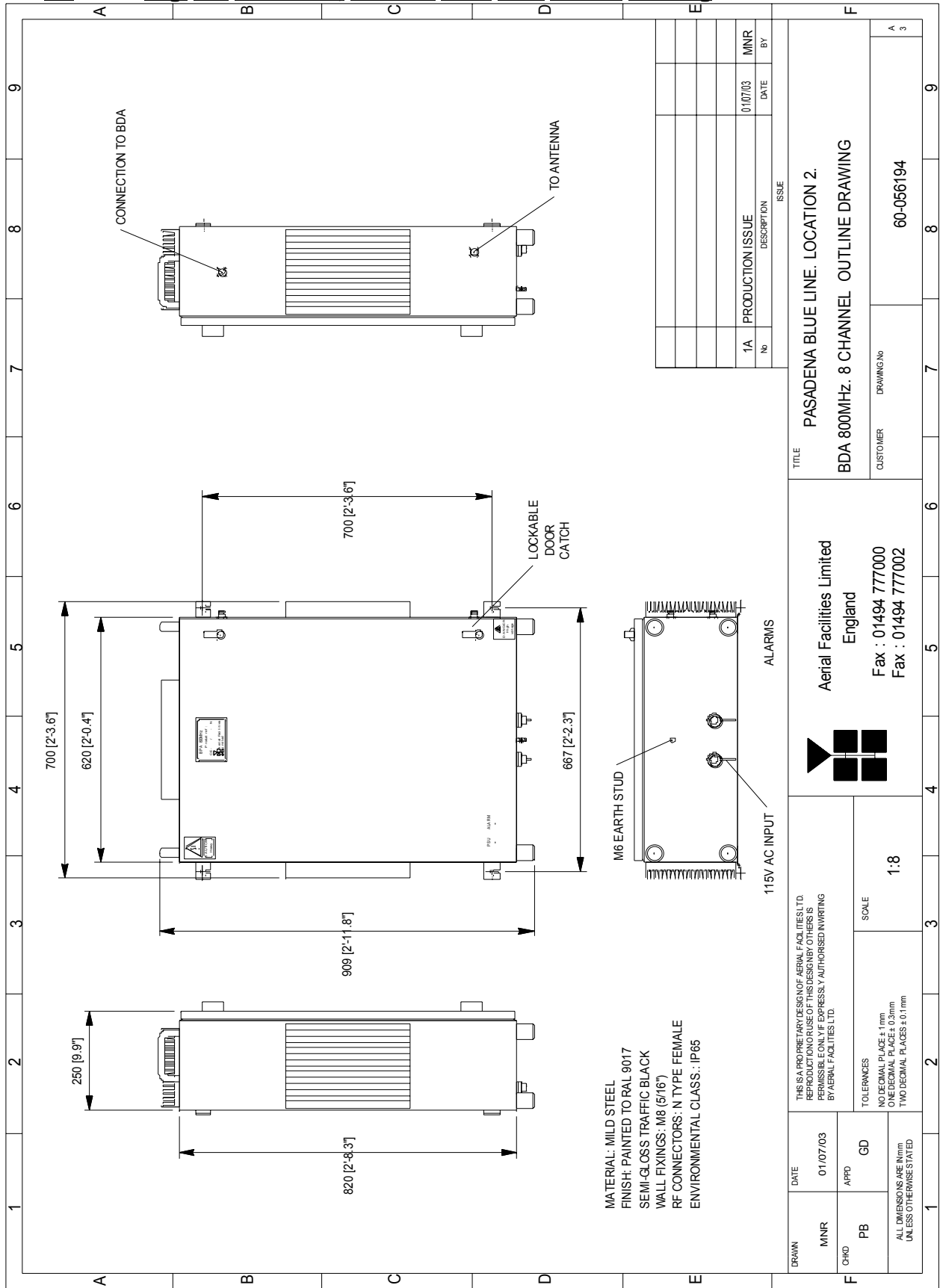

Aerial Facilities Limited
www.AerialFacilities.com
Technical Literature

800MHz BDA (Pasadena Figuero Tunnel)
 Maintenance Handbook

| | | | |
|------------------------------|-------------|------------------|----------------|
| H/book Number:-60-056100HBKM | Issue No:-1 | Date:-21/10/2003 | Page:-15 of 52 |
|------------------------------|-------------|------------------|----------------|

5. SUB-UNIT MODULES

5.1 Bandpass Filter (02-011601)

5.1.1 Description

The bandpass filters are multi-section designs with a bandwidth dependent upon the passband frequencies, (both tuned to customer requirements). The response shape is basically Chebyshev with a passband design ripple of 0.1dB. The filters are of combline design, and are carefully aligned during manufacture in order to optimise the insertion loss, VSWR and intermodulation characteristics of the unit. The tuned elements are silver-plated to reduce surface ohmic losses and maintain a good VSWR figure and 50Ω load at the input and output ports.

Being passive devices, the bandpass filters should have an extremely long operational life and require no maintenance. Should a filter be suspect, it is usually most time efficient to replace the module rather than attempt repair or re-tuning.

5.1.2 Technical Specification

| PARAMETER | | SPECIFICATION |
|---------------------|------------|--|
| Response Type: | | Chebyshev |
| Frequency Range: | | 857-861MHz (Dlink) 812-816MHz (Ulink) |
| Bandwidth: | | <7.5 MHz (tuned to requirements) |
| Number of Sections: | | 8 |
| Insertion Loss: | | 1.2 dB |
| VSWR: | | better than 1.2:1 |
| Connectors: | | SMA |
| Power Handling: | | 100W max |
| Temperature range | operation: | -10°C to +55°C |
| | storage: | -40°C to +70°C |
| Weight: | | 3 kg (typical) |

5.2 2-Way Splitter/Combiner (05-002602)

5.2.1 Description

The Splitter/Combiner used is a device for accurately matching two or more RF signals to single or multiple ports; most usually within a specified frequency band, whilst maintaining an accurate 50Ω load to all inputs/outputs and ensuring that the VSWR and insertion losses are kept to a minimum. Any unused ports will be terminated with an appropriate 50Ω load.

5.2.2 Technical Specification

| PARAMETER | | SPECIFICATION |
|----------------------|-------------|---------------------------------------|
| Frequency Range: | Narrowband: | 800-1000MHz |
| | Broadband: | 600-1300MHz |
| Bandwidth: | Narrowband: | 300 MHz |
| | Broadband: | 700 MHz |
| Inputs: | | 1 |
| Outputs: | | 2 |
| Isolation: | Narrowband: | >20 dB |
| | Broadband: | >18 dB |
| Insertion Loss: | Narrowband: | 3.3 dB |
| | Broadband: | 3.5 dB |
| VSWR Input & Output: | | Better than 1.3:1 |
| Impedance: | | 50 Ω |
| Connectors: | | SMA female |
| Weight: | | 200gms |
| Size: | | 54 x 44 x 21mm (including connectors) |
| Power Rating: | Splitter: | 20 Watts |
| | Combiner: | 0.5Watts |

5.3 4-Way Splitter/Combiner (05-003302)

5.3.1 Description

The Splitter/Combiner used is a device for accurately matching two or more RF signals to single or multiple ports, whilst maintaining an accurate 50Ω load to all inputs/outputs and ensuring that the VSWR and insertion losses are kept to a minimum. Any unused ports will be terminated with an appropriate 50Ω load. This splitter is used in conjunction with the previously mentioned 05-002602 to split & combine the signal before and after the channel selective modules (in both up & downlink paths).

5.3.2 Technical Specification

| PARAMETER | | SPECIFICATION |
|--------------------|-------------|-----------------|
| Frequency range: | | 700-1000MHz |
| Bandwidth: | | >200MHz |
| Rejection: | | >14dB |
| Insertion loss: | | 6.5dB (typical) |
| Connectors: | | SMA |
| Weight: | | <1.5kg |
| Temperature range: | operational | -10BC to +55BC |
| | storage | -40BC to +70BC |

5.4 ¼Watt 0- -30dB Switched Attenuator (10-000701)

5.4.1 General Application

In many practical applications for Cell Enhancers etc., the gain in each path is found to be excessive. Therefore, provision is made within the unit for the setting of attenuation in each path, to reduce the gain.

5.4.2 Switched Attenuators

The AFL switched attenuators are available in two different types; 0 – 30dB in 2 dB steps (as in this case), or 0 – 15dB in 1 dB steps. The attenuation is simply set using the four miniature toggle switches on the top of each unit. Each switch is clearly marked with the attenuation it provides, and the total attenuation in line is the sum of the values switched in. They are designed to maintain an accurate 50Ω impedance over their operating frequency at both input and output.

5.5 Low Noise Amplifiers (11-005902 & 11-006702)

5.5.1 Description

The Gallium-Arsenide low noise amplifiers used in the unit are double stage, solid-state low noise amplifiers. Class A circuitry is used throughout the units to ensure excellent linearity and extremely low noise over a very wide dynamic range. The active devices are very moderately rated to provide a long trouble-free working life. There are no adjustments on these amplifiers, and in the unlikely event of a failure, then the complete amplifier should be replaced. This amplifier features its own in-built alarm system which gives a volt-free relay contact type alarm that is easily integrated into the main alarm system.

5.5.2 Technical Specification (11-005902)

| PARAMETER | | SPECIFICATION |
|---------------------------|--------------|------------------------|
| Frequency Range: | | 800 – 960MHz |
| Bandwidth: | | <170MHz |
| Gain: | | 19.5dB (typical) |
| 1dB Compression Point: | | 21dBm |
| OIP3: | | 33dBm |
| Input/Output Return Loss: | | >20dB |
| Noise Figure: | | 1dB (typical) |
| Power Consumption: | | 190mA @ 24V DC |
| Supply Voltage: | | 10-24V DC |
| Connectors: | | SMA female |
| Temperature Range: | operational: | -10°C to +55°C |
| | storage: | -40°C to +70°C |
| Size: | | 90 x 55 x 30.2mm |
| Weight: | | 280gms (approximately) |

5.5.3 Drg. N^o. 11-005902 LNA General Assembly Drawing

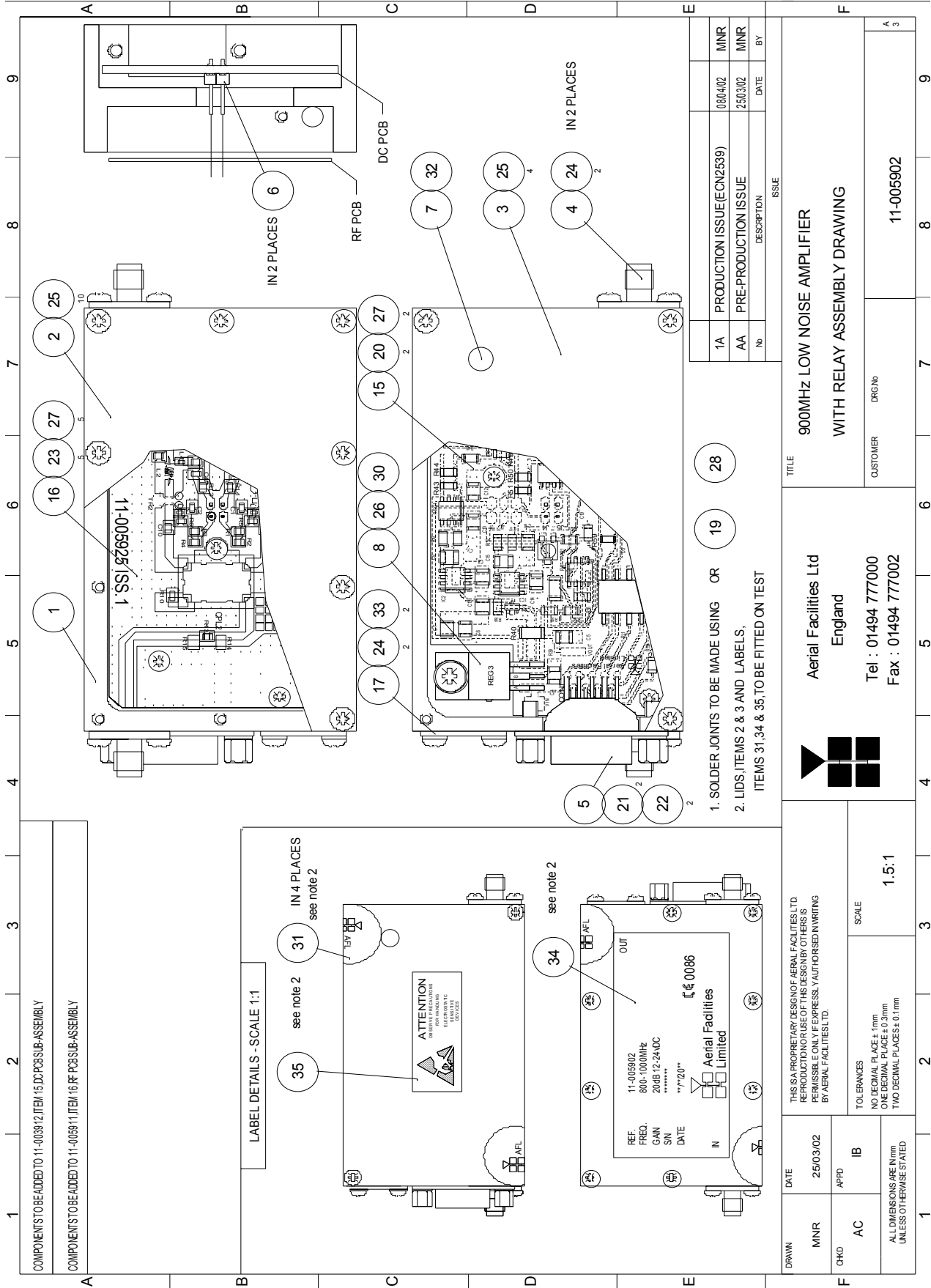

| No | DESCRIPTION | DATE | BY |
|----|----------------------------|----------|-----|
| 1A | PRODUCTION ISSUE (ECN2539) | 08/04/02 | MNR |
| AA | PRE-PRODUCTION ISSUE | 25/03/02 | MNR |

1. SOLDER JOINTS TO BE MADE USING OR 19
 2. LIDS ITEMS 2 & 3 AND LABELS, ITEMS 31, 34 & 35, TO BE FITTED ON TEST

| | | | | | | | | | | |
|--|---|----------------------------|---|---|-------|-------|-------|-------|----|---|
| <table border="1"> <tr> <td>DRAWN</td> <td>DATE</td> <td>25/03/02</td> <td rowspan="2"> THIS IS A PROPRIETARY DESIGN OF AERIAL FACILITIES LTD. REPRODUCTION OR USE OF THIS DESIGN BY OTHERS IS PERMITTED ONLY BY EXPRESSLY AUTHORISED IN WRITING BY AERIAL FACILITIES LTD. </td> <td rowspan="2">SCALE</td> <td rowspan="2">1.5:1</td> </tr> <tr> <td>MNR</td> <td>APPD</td> <td>IB</td> </tr> </table> | DRAWN | DATE | 25/03/02 | THIS IS A PROPRIETARY DESIGN OF AERIAL FACILITIES LTD. REPRODUCTION OR USE OF THIS DESIGN BY OTHERS IS PERMITTED ONLY BY EXPRESSLY AUTHORISED IN WRITING BY AERIAL FACILITIES LTD. | SCALE | 1.5:1 | MNR | APPD | IB | TITLE 900MHz LOW NOISE AMPLIFIER WITH RELAY ASSEMBLY DRAWING |
| DRAWN | DATE | 25/03/02 | THIS IS A PROPRIETARY DESIGN OF AERIAL FACILITIES LTD. REPRODUCTION OR USE OF THIS DESIGN BY OTHERS IS PERMITTED ONLY BY EXPRESSLY AUTHORISED IN WRITING BY AERIAL FACILITIES LTD. | | | | SCALE | 1.5:1 | | |
| MNR | APPD | IB | | | | | | | | |
| <table border="1"> <tr> <td> CUSTOMER Aerial Facilities Ltd England </td> <td> DRG.No 11-005902 </td> </tr> </table> | CUSTOMER Aerial Facilities Ltd England | DRG.No 11-005902 | ISSUE No. 1 DESCRIPTION DATE BY | | | | | | | |
| CUSTOMER Aerial Facilities Ltd England | DRG.No 11-005902 | | | | | | | | | |

COMPONENTS TO BE ADDED TO 11-003912/ITEM 15, DC PCB SUB-ASSEMBLY
 COMPONENTS TO BE ADDED TO 11-005911/ITEM 16, RF PCB SUB-ASSEMBLY

LABEL DETAILS - SCALE 1:1

5.5.4 Drg. N^o. 11-005970, LNA Circuit Diagram (RF)

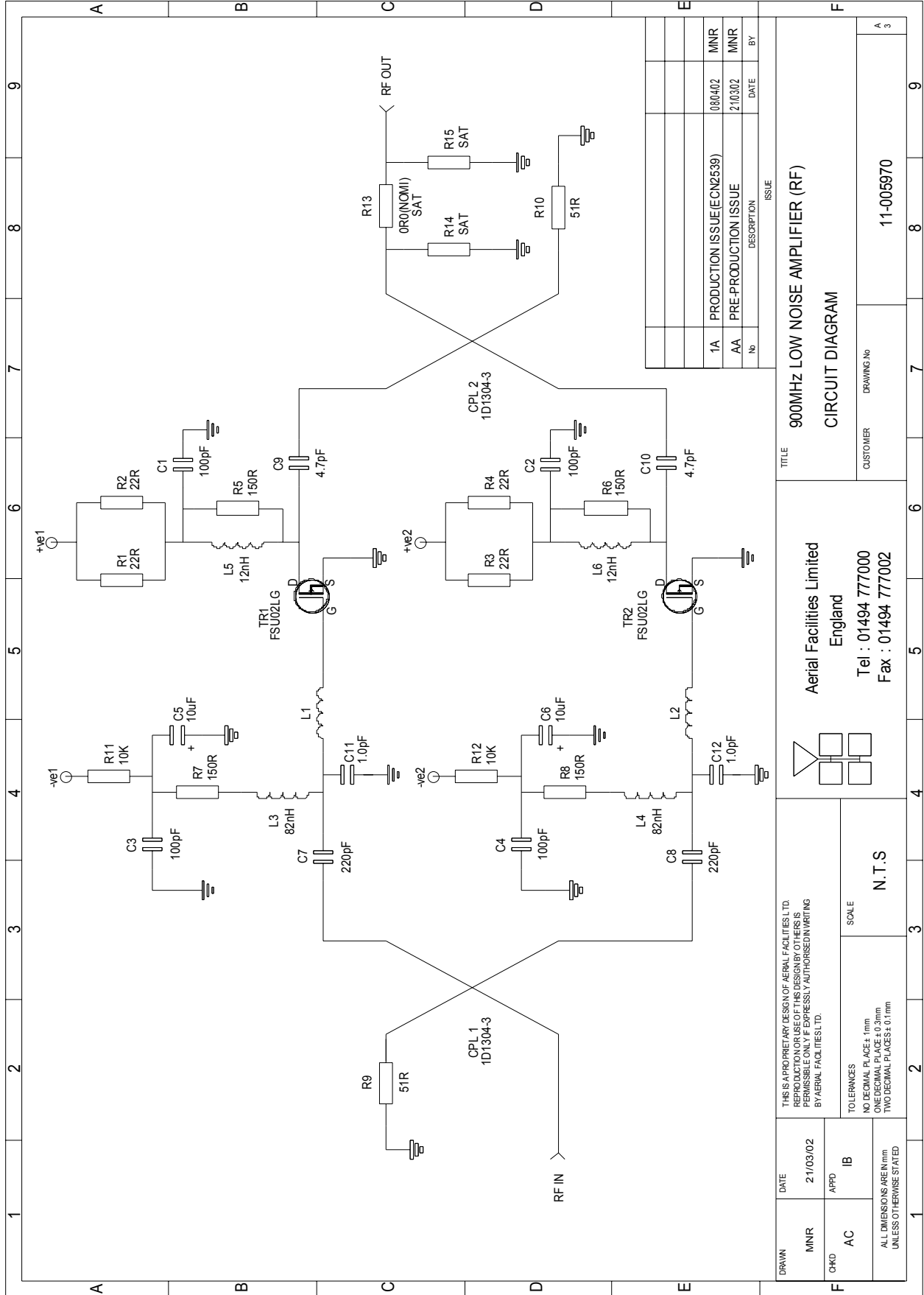

| No | DESCRIPTION | DATE | BY |
|----|---------------------------|----------|-----|
| 1A | PRODUCTION ISSUE(ECN2539) | 08/04/02 | MNR |
| AA | PRE-PRODUCTION ISSUE | 21/03/02 | MNR |

| | | |
|-----------------|------------|---------------------------------|
| TITLE | | 900MHz LOW NOISE AMPLIFIER (RF) |
| CIRCUIT DIAGRAM | | |
| CUSTOMER | DRAWING No | 11-005970 |

Aerial Facilities Limited
 England
 Tel : 01494 777000
 Fax : 01494 777002

| | |
|---|----------|
| THIS IS A PROPRIETARY DESIGN OF AERIAL FACILITIES LTD. REPRODUCTION OR USE OF THIS DESIGN OR THE INFORMATION CONTAINED HEREIN IS PROHIBITED WITHOUT THE EXPRESSLY AUTHORISED WRITING BY AERIAL FACILITIES LTD. | SCALE |
| TOLERANCES NO DECIMAL PLACES - 1mm ONE DECIMAL PLACE - 0.1mm TWO DECIMAL PLACES - 0.01mm UNLESS OTHERWISE STATED | N.T.S |
| DATE | 21/03/02 |
| APPR | IB |
| CHD | AC |

5.5.5 Drg. N^o. 11-005971, LNA Circuit Diagram (DC Wiring Layout)

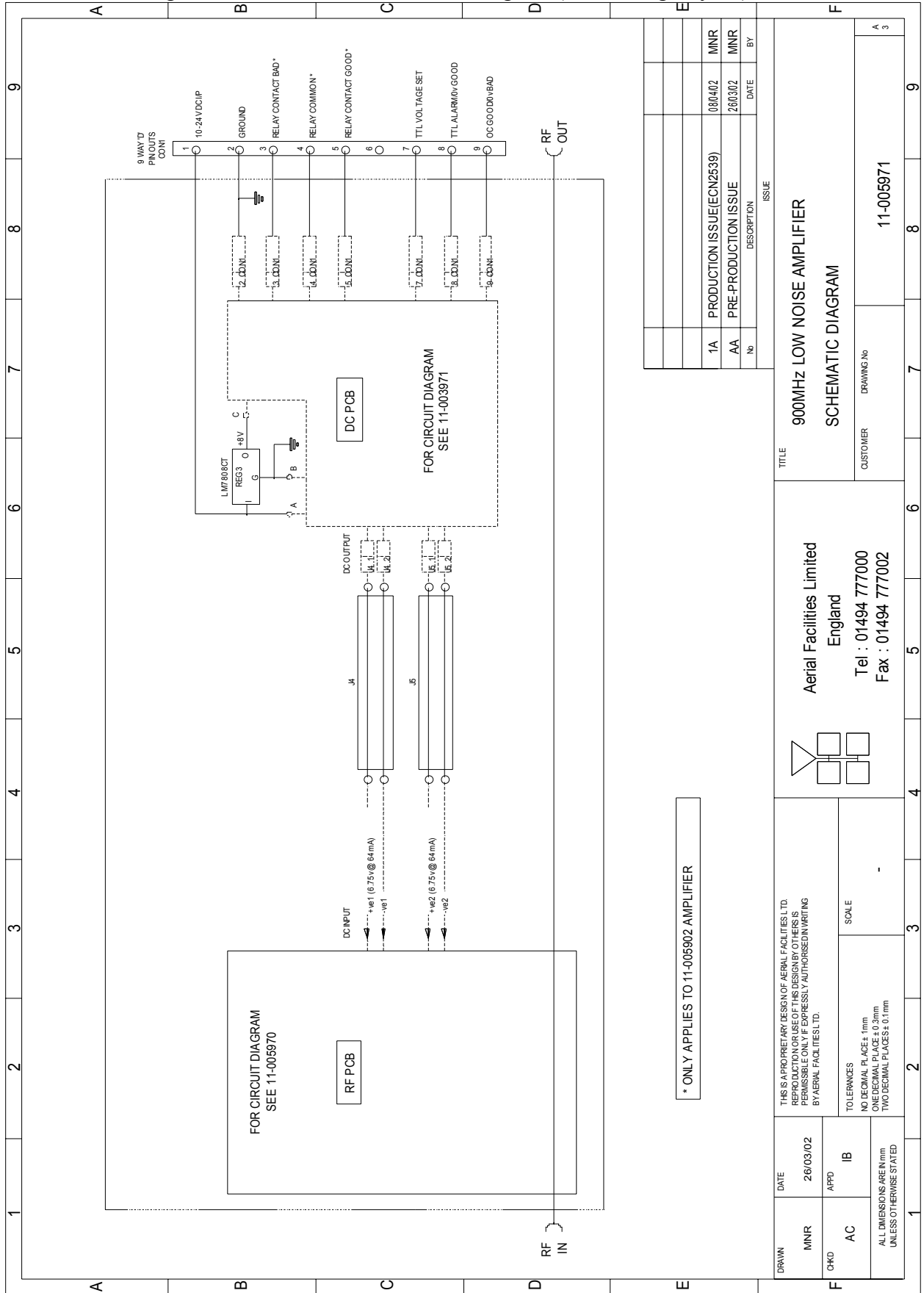

| No | DESCRIPTION | DATE | BY |
|----|----------------------------|----------|-----|
| 1A | PRODUCTION ISSUE (ECN2539) | 08/04/02 | MNR |
| AA | PRE-PRODUCTION ISSUE | 26/03/02 | MNR |

| DRAWN | | DATE | | TITLE | |
|---|----|----------|----|----------------------------|--|
| MNR | AC | 26/03/02 | IB | 900MHz LOW NOISE AMPLIFIER | |
| <p>THIS IS A PROPRIETARY DESIGN OF AERIAL FACILITIES LTD. PERMISSION TO REPRODUCE THIS DESIGN OR ANY PART THEREOF IS HEREBY EXPRESSLY AUTHORISED IN WRITING BY AERIAL FACILITIES LTD.</p> | | | | SCHEMATIC DIAGRAM | |
| <p>TOLERANCES NO DECIMAL PLACES = 1mm ONE DECIMAL PLACE = 0.1mm TWO DECIMAL PLACES = 0.1mm UNLESS OTHERWISE STATED</p> | | | | CUSTOMER DRAWING No | |
| <p>SCALE</p> | | | | 11-005971 | |
| <p>AERIAL FACILITIES LIMITED England Tel : 01494 777000 Fax : 01494 777002</p> | | | | A 3 | |

5.5.6 Technical Specification (11-006702)

| PARAMETER | | SPECIFICATION |
|---------------------------|--------------|------------------------|
| Frequency Range: | | 800 – 1000MHz |
| Bandwidth: | | <200MHz |
| Gain: | | 29dB (typical) |
| 1dB Compression Point: | | 20dBm |
| OIP3: | | 33dBm |
| Input/Output Return Loss: | | >18dB |
| Noise Figure: | | 1.3dB (typical) |
| Power Consumption: | | 180mA @ 24V DC |
| Supply Voltage: | | 10-24V DC |
| Connectors: | | SMA female |
| Temperature Range: | operational: | -10°C to +55°C |
| | storage: | -40°C to +70°C |
| Size: | | 90 x 55 x 30.2mm |
| Weight: | | 290gms (approximately) |

5.5.7 Drg. N^o. 11-006702, LNA General Assembly Drawing

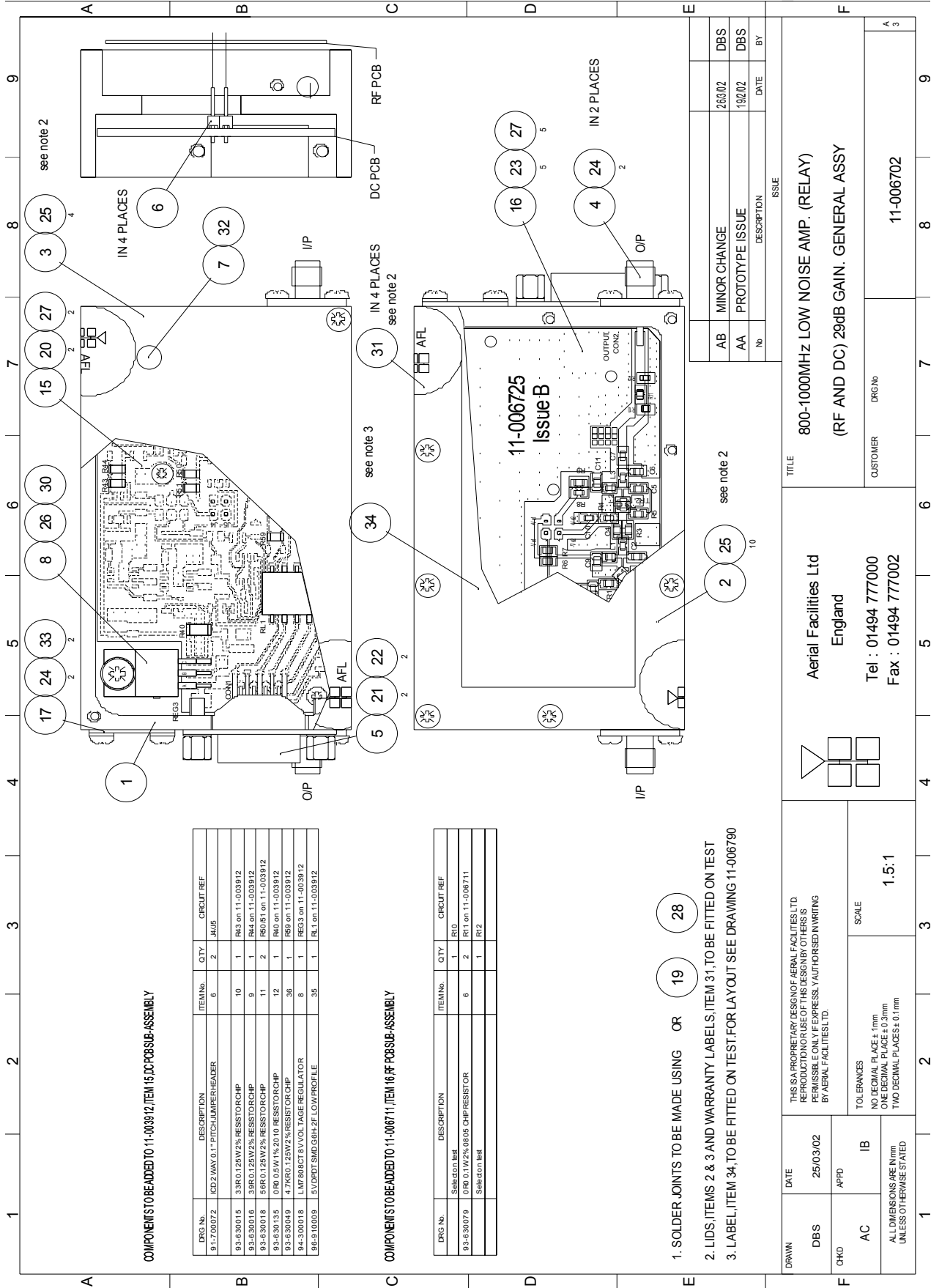

COMPONENTS TO BE ADDED TO 11-008912 ITEM 15 DC PCB SUB-ASSEMBLY

| DRG No. | DESCRIPTION | ITEM No. | QTY | CIRCUIT REF |
|-----------|-----------------------------------|----------|-----|-------------------|
| 91-700072 | ICD2 WAY 0.1" PITCH LUMPER HEADER | 6 | 2 | J4/J5 |
| 93-630015 | 3.9K 0.125W 2% RESISTOR CHIP | 10 | 1 | R43 on 11-003912 |
| 93-630016 | 3.9K 0.125W 2% RESISTOR CHIP | 8 | 1 | R44 on 11-003912 |
| 93-630018 | 3.9K 0.125W 2% RESISTOR CHIP | 11 | 2 | R45 on 11-003912 |
| 93-630135 | 010 0.5W 1% 2010 RESISTOR CHIP | 12 | 1 | R40 on 11-003912 |
| 93-630049 | 4.7K 0.125W 2% RESISTOR CHIP | 36 | 1 | R59 on 11-003912 |
| 94-300018 | LW760BCT 8V VOL TAGE REGULATOR | 8 | 1 | REG3 on 11-003912 |
| 96-910089 | 5V DROT SMD GND-ZF LOW PROFILE | 35 | 1 | RL1 on 11-003912 |

COMPONENTS TO BE ADDED TO 11-006711 ITEM 16 RF PCB SUB-ASSEMBLY

| DRG No. | DESCRIPTION | ITEM No. | QTY | CIRCUIT REF |
|-----------|--------------------------------|----------|-----|------------------|
| 93-630079 | Selection list | 1 | 1 | R10 |
| | 010 0.1W 2% 0805 CHIP RESISTOR | 6 | 2 | R11 on 11-006711 |
| | Selection list | 1 | 1 | R12 |

1. SOLDER JOINTS TO BE MADE USING OR 19 28
2. LIDS, ITEMS 2 & 3 AND WARRANTY LABELS, ITEM 31, TO BE FITTED ON TEST
3. LABEL, ITEM 34, TO BE FITTED ON TEST. FOR LAYOUT SEE DRAWING 11-006790

| ISSUE | DESCRIPTION | DATE | BY |
|-------|-----------------|-------|-----|
| AB | MINOR CHANGE | 26/02 | DBS |
| AA | PROTOTYPE ISSUE | 19/02 | DBS |
| No | | | |

| | | | | | |
|--|----------|---|--|-----------|--------|
| DRAWN | DATE | TITLE | CUSTOMER | DRG No | A 3 |
| DBS | 25/03/02 | 800-1000MHZ LOW NOISE AMP. (RELAY) (RF AND DC) 29dB GAIN. GENERAL ASSY | Aerial Facilities Ltd England | 11-006702 | 9 |
| CHKD | APPD | | Tel : 01494 777000 Fax : 01494 777002 | | 8 |
| AC | IB | | | | 7 |
| ALL DIMENSIONS ARE IN mm UNLESS OTHERWISE STATED | | SCALE | | | 6 |
| | | 1.5:1 | | | 5 |
| | | | | | 4 |
| | | | | | 3 |
| | | | | | 2 |
| | | | | | 1 |

5.5.9 Drg. N^o. 11-006771, LNA DC Wiring Diagram

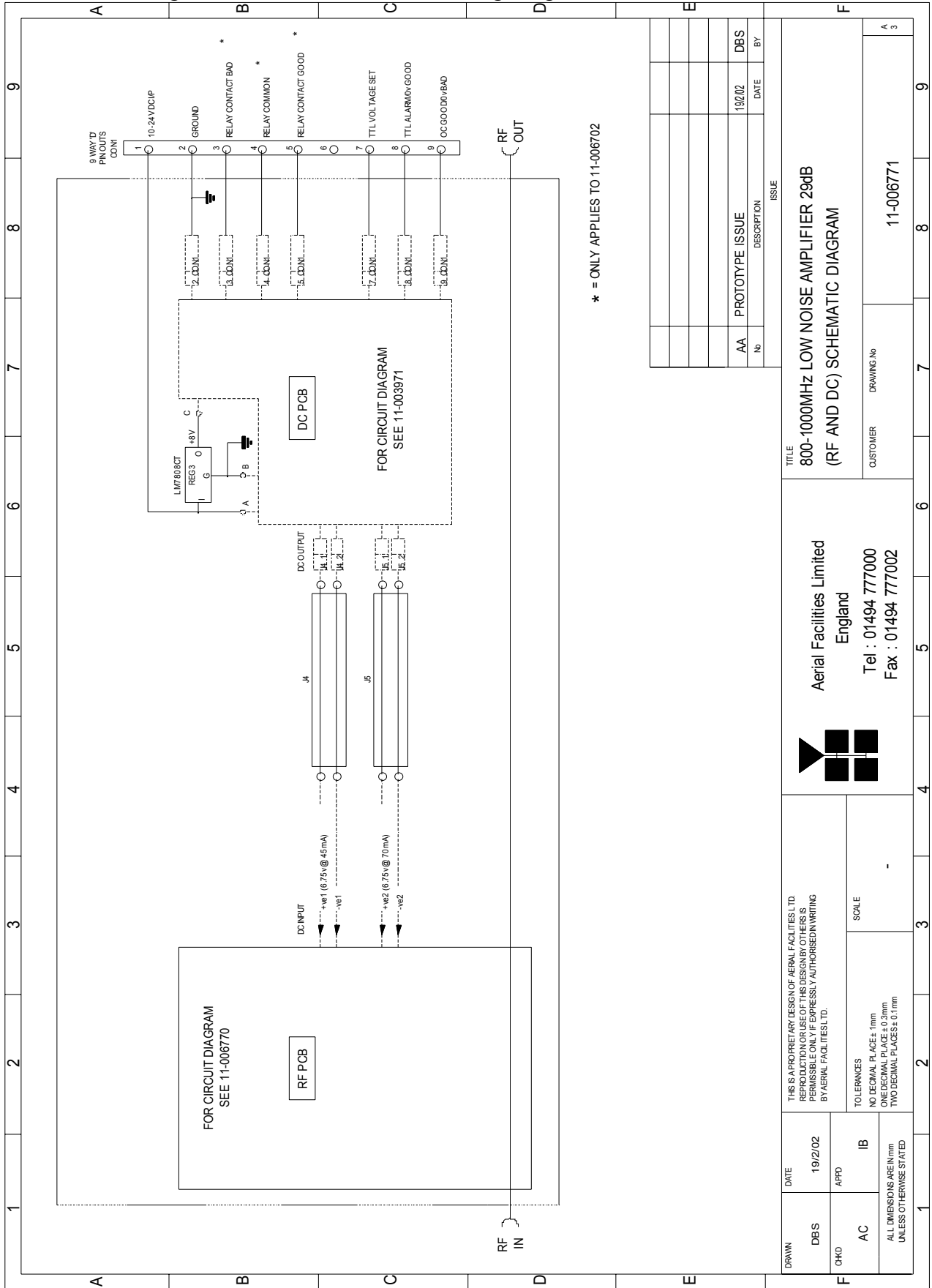

| | | | |
|----|-----------------|-------|-----|
| AA | PROTOTYPE ISSUE | 19/02 | DBS |
| No | DESCRIPTION | DATE | BY |

| | |
|---|------------|
| TITLE | |
| 800-1000MHz LOW NOISE AMPLIFIER 29dB (RF AND DC) SCHEMATIC DIAGRAM | |
| CUSTOMER | DRAWING No |
| | 11-006771 |

Aerial Facilities Limited
 England
 Tel : 01494 777000
 Fax : 01494 777002

| | | | | |
|---|-------|---------|-------|--|
| THIS IS PROPRIETARY DESIGN OF AERIAL FACILITIES LTD. REPRODUCTION OR USE OF THIS DESIGN BY OTHERS IS PERMISSIBLE ONLY IF EXPRESSLY AUTHORISED IN WRITING BY AERIAL FACILITIES LTD. | DATE | 19/2/02 | SCALE | |
| TOLERANCES | AC | IB | | |
| NO DECIMAL PLACE ± 1mm ONE DECIMAL PLACE ± 0.3mm TWO DECIMAL PLACES ± 0.1mm UNLESS OTHERWISE STATED | APPRO | | | |

5.6 10Watt Power Amplifier (12-002105)

5.6.1 Description

The power amplifiers fitted to this unit (up & downlink paths) are multi-stage, solid state power amplifiers. Class A circuitry is employed throughout the device to ensure excellent linearity over a wide dynamic frequency range. All the semi-conductor devices are very conservatively rated to ensure low device junction temperatures and a long, trouble free working lifetime.

The power amplifiers should require no maintenance over their operating life. Under no circumstances should the cover be removed or the side adjustments disturbed unless it is certain that the amplifier has failed; since it is critically aligned during manufacture and any re-alignment will require extensive test equipment.

5.6.2 Technical Specification

| PARAMETER | | SPECIFICATION |
|--|--------------|---------------------------------------|
| Frequency range: | | 800 - 970MHz (tuned to spec.) |
| Bandwidth: | | 10 - 100MHz (typical, tuned to spec.) |
| Maximum RF output: | | >10.0 Watt |
| Gain: | | 30dB |
| 1dB compression point: | | +40dBm |
| 3 rd order intercept point: | | +50dBm |
| VSWR: | | better than 1.5:1 |
| Connectors: | | SMA female |
| Supply: | | 2.8A @ 24V DC |
| Temperature range: | operational: | -10°C to +55°C |
| | storage: | -40°C to +70°C |
| Weight: | | 1.5 Kg (case only) |

5.6.3 Drg. No. 12-002105, 10W PA Assembly Drawing

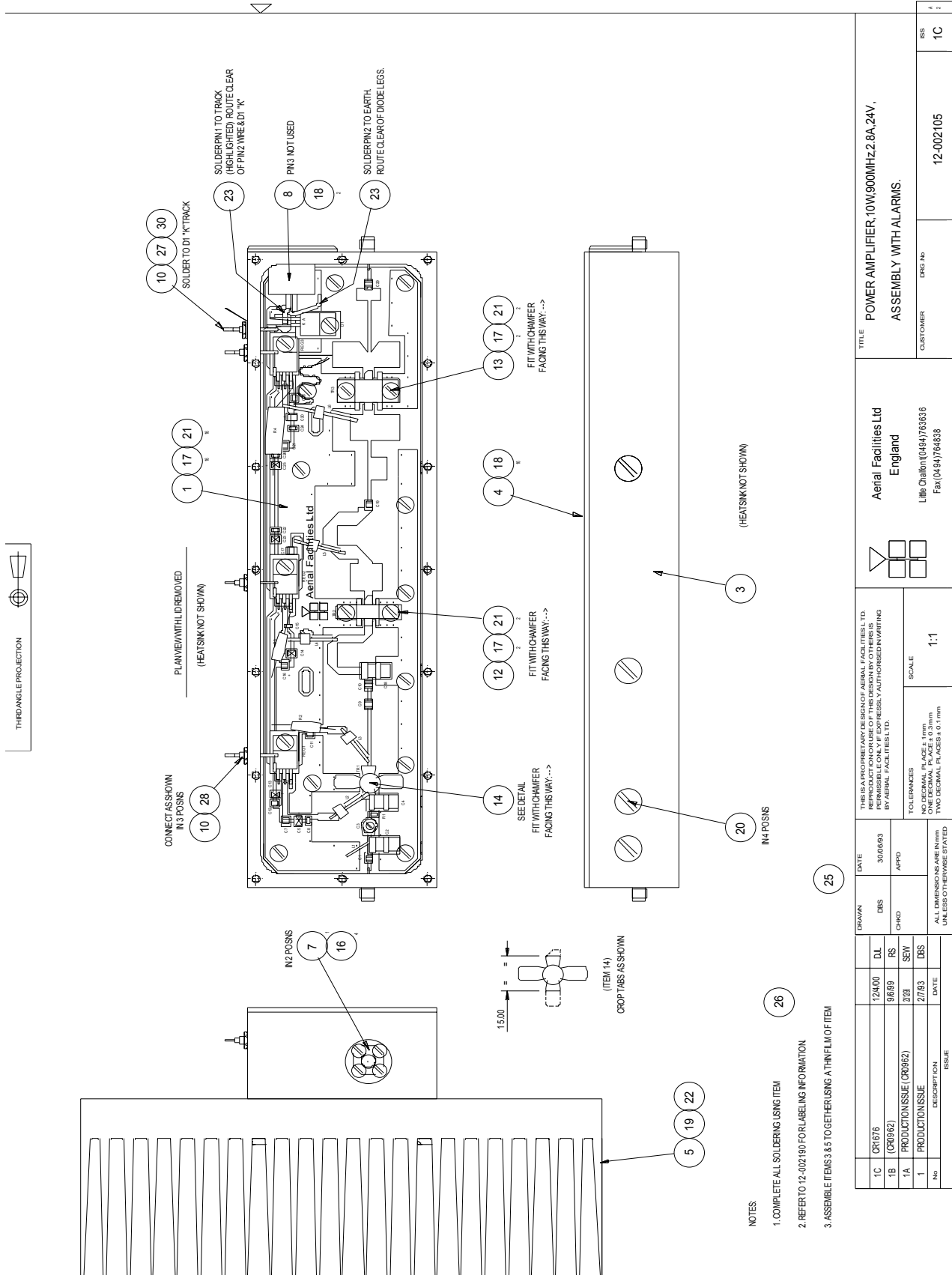

- NOTES:
1. COMPLETE ALL SOLDERING USING ITEM 26
 2. REFER TO 12-002190 FOR LABELING INFORMATION
 3. ASSEMBLE ITEMS 3 & 5 TOGETHER USING A THIN FILM OF ITEM 25

5.6.4 Drg. N^o. 12-001275, 10W PA Circuit Diagram

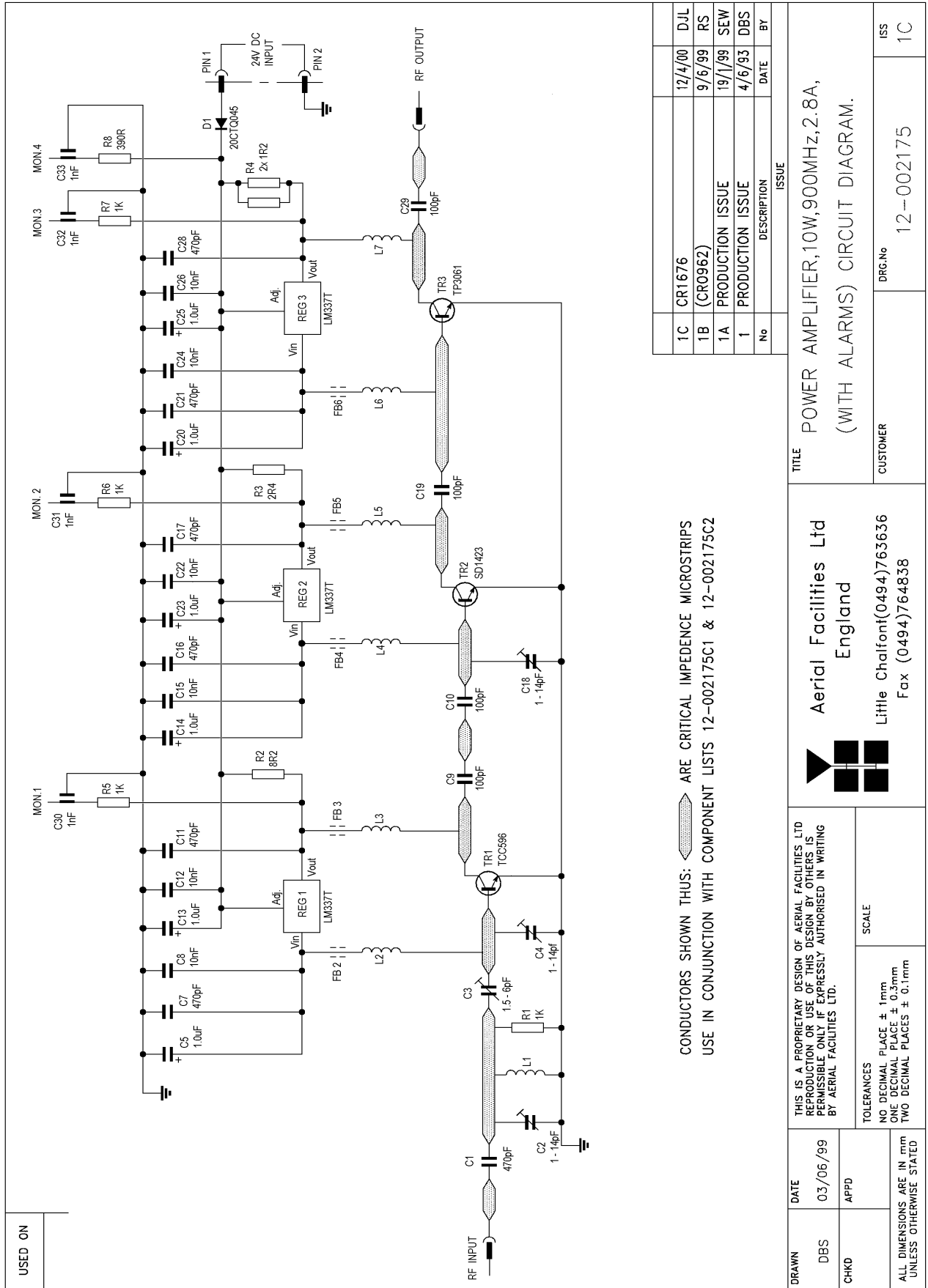

| | | | |
|----|------------------|---------|-----|
| 1C | CR1676 | 12/4/00 | DJL |
| 1B | (CR0962) | 9/6/99 | RS |
| 1A | PRODUCTION ISSUE | 19/1/99 | SEW |
| 1 | PRODUCTION ISSUE | 4/6/93 | DBS |
| No | | DATE | BY |

CONDUCTORS SHOWN THUS: ARE CRITICAL IMPEDENCE MICROSTRIPS
USE IN CONJUNCTION WITH COMPONENT LISTS 12-002175C1 & 12-002175C2

| | | | | | | |
|--|------|------|----------|--------|---|-----------|
| DRAWN | DBS | DATE | 03/06/99 | TITLE | POWER AMPLIFIER, 10W, 900MHz, 2.8A, (WITH ALARMS) CIRCUIT DIAGRAM. | |
| | CHKD | APPD | | | CUSTOMER | 12-002175 |
| THIS IS A PROPRIETARY DESIGN OF AERIAL FACILITIES LTD REPRODUCTION OR USE OF THIS DESIGN BY OTHERS IS PERMISSIBLE ONLY IF EXPRESSLY AUTHORISED IN WRITING BY AERIAL FACILITIES LTD. | | | | ISS | | |
| TOLERANCES | | | | DRG.No | | |
| NO DECIMAL PLACE ± 1mm | | | | 1C | | |
| ONE DECIMAL PLACE ± 0.3mm | | | | | | |
| TWO DECIMAL PLACES ± 0.1mm | | | | | | |
| UNLESS OTHERWISE STATED | | | | | | |

Aerial Facilities Limited
www.AerialFacilities.com
Technical Literature

800MHz BDA (Pasadena Figuero Tunnel)
Maintenance Handbook

H/book Number:-60-056100HBKM Issue No:-1 Date:-21/10/2003 Page:-30 of 52

5.6.5 Drg. Nō. 12-002175C12, PA Parts List(1)

| USED ON | CIRC. REF. | AFL STOCK REF. | DESCRIPTION |
|---------|------------|----------------|-----------------------|
| | C1 | 93-200017 | 470pF CERAMIC CAP 10 |
| | C2 | 93-130023 | 1-14pF AIR TRIM CAP |
| | C3 | 93-130014 | 1.5-6.0pF CERAMIC CAP |
| | C4 | 93-130023 | 1-14pF AIR TRIM CAP |
| | C5 | 93-240004 | 1uF 35V TANTALUM CHI |
| | C6 | | |
| | C7 | 93-200017 | 470pF CERAMIC CAP 10 |
| | C8 | 93-200019 | 10nF 50V CERAMIC CA |
| | C9 | 93-200007 | 100pF CERAMIC CAP 10 |
| | C10 | 93-200007 | 100pF CERAMIC CAP 10 |
| | C11 | 93-200017 | 470pF CERAMIC CAP 10 |
| | C12 | 93-200019 | 10nF 50V CERAMIC CA |
| | C13 | 93-240004 | 1uF 35V TANTALUM CHI |
| | C14 | 93-240004 | 1uF 35V TANTALUM CHI |
| | C15 | 93-200019 | 10nF 50V CERAMIC CA |
| | C16 | 93-200017 | 470pF CERAMIC CAP 10 |
| | C17 | 93-200017 | 470pF CERAMIC CAP 10 |
| | C18 | 93-130023 | 1-14pF AIR TRIM CAP |
| | C19 | 93-200007 | 100pF CERAMIC CAP 10 |
| | C20 | 93-240004 | 1uF 35V TANTALUM CHI |
| | C21 | 93-200017 | 470pF CERAMIC CAP 10 |
| | C22 | 93-200019 | 10nF 50V CERAMIC CA |
| | C23 | 93-240004 | 1uF 35V TANTALUM CHI |
| | C24 | 93-200019 | 10nF 50V CERAMIC CA |
| | C25 | 93-240004 | 1uF 35V TANTALUM CHI |
| | C26 | 93-200019 | 10nF 50V CERAMIC CA |
| | C27 | | |
| | C28 | 93-200017 | 470pF CERAMIC CAP 10 |
| | C29 | 93-200007 | 100pF CERAMIC CAP 10 |
| | C30 | 93-150001 | 1nF FEED THROUGH CAP |
| | C31 | 93-150001 | 1nF FEED THROUGH CAP |
| | C32 | 93-150001 | 1nF FEED THROUGH CAP |
| | C33 | 93-150001 | 1nF FEED THROUGH CAP |

| 2A | 12/4/00 | CR1676 | | | | | | | | | |
|-------|---------|------------|-------|------|-----------|-------|------|-----------|-------|------|-----------|
| 1A | 3/6/99 | (CR0962) | | | | | | | | | |
| 1 | 30/6/93 | Prod. Iss. | | | | | | | | | |
| ISSUE | DATE | CHANGE No | ISSUE | DATE | CHANGE No | ISSUE | DATE | CHANGE No | ISSUE | DATE | CHANGE No |

| | | | | | | | | | | | | | | |
|--|--|--|--|---|--|--|--|------------------|--|------|--|------|--|----------|
|  Aerial Facilities Limited | | | | TITLE POWER AMPLIFIER,10W,900MHz,2.8A,(WITH ALARMS) COMPONENT LIST - SHEET 1 OF 2 | | | | | | | | | | |
| | | | | DRAWN DBS | | | | DATE 30/06/93 | | CHKD | | APPD | | CUSTOMER |

| | | | | | | | | | | | |
|---|--|--|--|---|--|------------------|--|----------------|--|--|--|
|  Aerial Facilities Limited www.AerialFacilities.com Technical Literature | | | | 800MHz BDA (Pasadena Figuero Tunnel) Maintenance Handbook | | | | | | | |
| H/book Number:-60-056100HBKM | | | | Issue No:-1 | | Date:-21/10/2003 | | Page:-31 of 52 | | | |

5.6.6 Drg. No. 12-002175C2, PA Parts List(2)

| USED ON | CIRC. REF. | AFL STOCK REF. | DESCRIPTION |
|---------|------------|----------------|-------------------------------------|
| | D1 | 94-120006 | 20CTQ45 10A 45V DUA |
| | | | |
| | FB2 | 93-910001 | FERROX BEAD 3S1 5x2x |
| | FB3 | 93-910001 | FERROX BEAD 3S1 5x2x |
| | FB4 | 93-910001 | FERROX BEAD 3S1 5x2x |
| | FB5 | 93-910001 | FERROX BEAD 3S1 5x2x |
| | FB6 | 93-910001 | FERROX BEAD 3S1 5x2x |
| | FB7 | 93-910001 | FERROX BEAD 3S1 5x2x |
| | | | |
| | R1 | 93-630037 | 1KR 0.125W 2% CHIP RESIST |
| | R2 | 93-540080 | 8R2 2.5W % RESWELWYN |
| | R3 | 93-540077 | 2R4 2.5W % RESWELWYN |
| | R4 | 93-540075 | 1R2 2.5W % RES WELW x 2 IN PARALLEL |
| | R5 | 93-540033 | 1K 0.25W 1% RES MRS2 |
| | R6 | 93-540033 | 1K 0.25W 1% RES MRS2 |
| | R7 | 93-540033 | 1K 0.25W 1% RES MRS2 |
| | R8 | 93-540027 | 390R 0.25W 1% RES MR |
| | | | |
| | REG1 | 94-300002 | LM337T. VOLTAGE REGU |
| | REG2 | 94-300002 | LM337T. VOLTAGE REGU |
| | REG3 | 94-300002 | LM337T. VOLTAGE REGU |
| | TR1 | 94-010018 | TPV596A/SD1439/TCC59 * |
| | TR2 | 94-010016 | TP 3022A/SD1423 POWE * |
| | TR3 | 94-010017 | TP 3061.SD4701.R. * |
| | L1 | 90-500008 | 22 S.W.G. TINNED COP |
| | L2 | 90-500012 | 1.25 ENAMELLED COP |
| | L3 | 90-500012 | 1.25 ENAMELLED COP |
| | L4 | 90-500012 | 1.25 ENAMELLED COP |
| | L5 | 90-500012 | 1.25 ENAMELLED COP |
| | L6 | 90-500012 | 1.25 ENAMELLED COP |
| | L7 | 90-500012 | 1.25 ENAMELLED COP |
| | | | |
| | | | |

| 2A | 11/4/00 | CR1676 | | | | | | | | | |
|-------|---------|------------|-------|---------|-------------|-------|------|-----------|-------|------|-----------|
| 1A | 3/6/99 | (CR0962) | | | | | | | | | |
| 1 | 30/6/93 | Prod. Iss. | 2B | 26/4/00 | TITLE ERROR | | | | | | |
| ISSUE | DATE | CHANGE No | ISSUE | DATE | CHANGE No | ISSUE | DATE | CHANGE No | ISSUE | DATE | CHANGE No |

| | | | | | | | | | | | |
|--|--|--|--|--|---|------------------|------|------|----------|--|--|
|  Aerial Facilities Limited | | | | | TITLE POWER AMPLIFIER,10W,900MHz,2.8A,(WITH ALARMS) COMPONENT LIST - SHEET 2 OF 2 | | | | | | |
| | | | | | DRAWN DBS | DATE 30/06/93 | CHKD | APPD | CUSTOMER | | |

| | | | | | | | | | | | |
|---|--|--|--|--|---|--|------------------|--|----------------|--|--|
|  Aerial Facilities Limited www.AerialFacilities.com Technical Literature | | | | | 800MHz BDA (Pasadena Figuero Tunnel) Maintenance Handbook | | | | | | |
| H/book Number:-60-056100HBKM | | | | | Issue No:-1 | | Date:-21/10/2003 | | Page:-32 of 52 | | |

5.6.7 Drg. No. 80-008450, PA Alarm Wiring Details

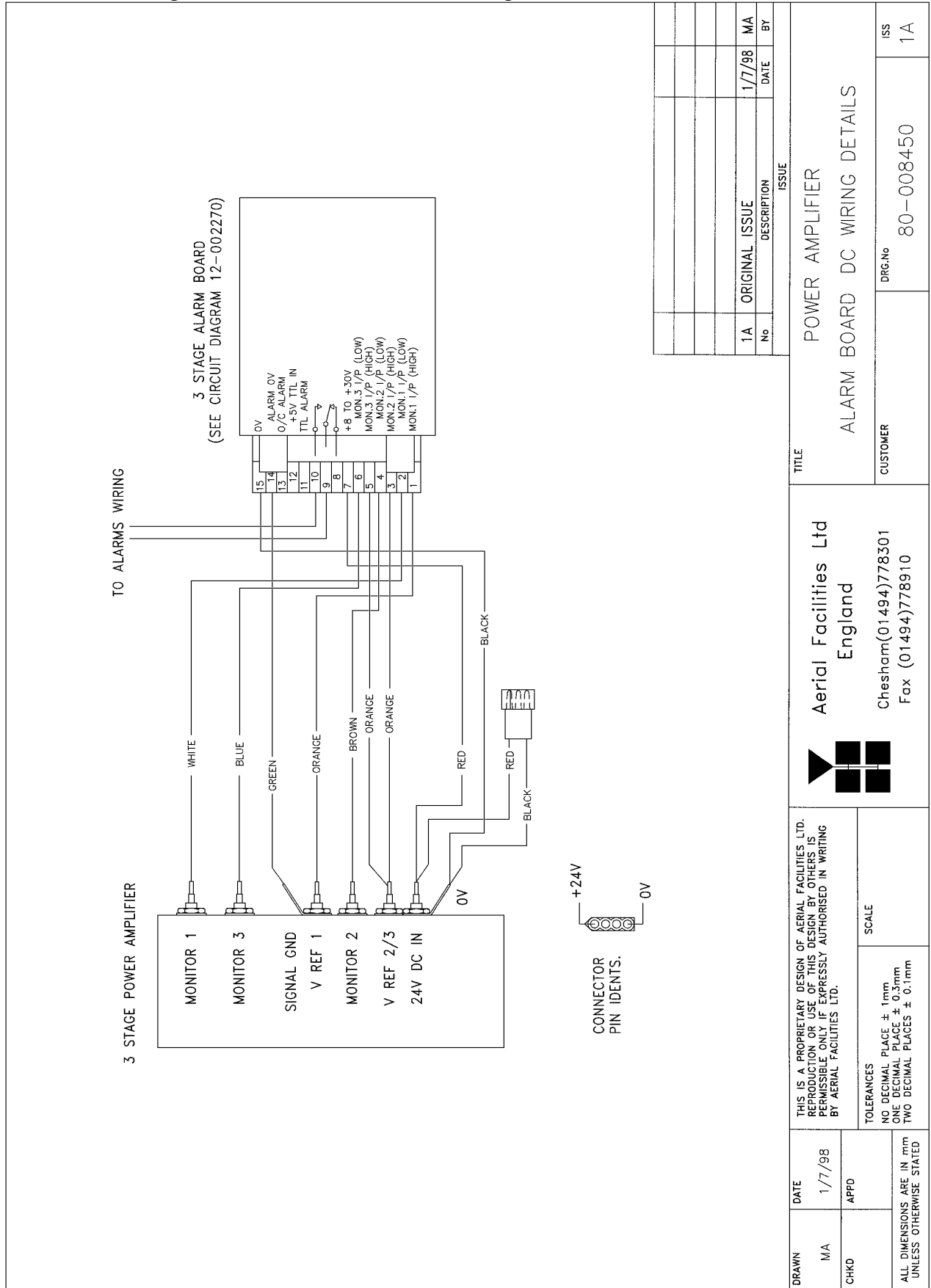

5.7 3 Stage Alarm Board (12-002201)

5.7.1 Description

Amplifier Alarm Boards are fitted to monitor the bias conditions of AFL Class A amplifiers which remain constant in normal operation. Any departure from normal bias conditions is a result of device failure, excess temperature, over-driving or oscillation (excessive power).

In normal operation, the Class A bias circuit of the amplifier develops a constant voltage of 1.20V across the collector current setting resistor. The Amplifier Alarm Board is a window comparator device, which is adjusted to sense a departure from this condition. Several different alarm outputs are provided to simplify interfacing, (Relay Contact, Open Collector, and TTL Logic Levels)

The basic version of the Alarm Board (12-002801) monitors a single amplifier stage. A three-stage version (12-002201) is used on complex amplifiers where three separate comparators have their outputs logically combined to a common output stage. Failure of any one stage will activate the alarms.

Note that the alarm board has a green Light Emitting Diode located near to the centre of the printed circuit board, which is illuminated on 'Good', and extinguished on 'Alarm'. It is therefore a simple matter to identify an active module failure, by searching for an Alarm Board which has its green LED extinguished. A simple test of the alarm board is possible by shorting across the monitor inputs, pins 1 and 2, 3 and 4 or across pins 5 and 6. This last monitor input is inactive if the board has been converted to a two way alarm board. (Refer to relevant amplifier alarm wiring diagram.)

- 1) Volt-free change over relay contacts.
- 2) Open collector NPN transistor pulls low on alarm.
- 3) TTL driver.

The use of precision voltage sources and resistors has eliminated the need for initial adjustment or calibration, and the board will function correctly with a wide variation in power supply voltage (8 to 30 volts, nominal supply is 12 or 24Volts).

There are two selectable link options on the three-way board:

- LINK1 - Removed to convert to two-way alarm board.
- LINK2 - Removed to isolate 0V from chassis earth.

The one way alarm board only has the 0V isolation link (LINK2) fitted.

| | | | |
|--|---|-------------|--------------------------|
|  Aerial Facilities Limited <small>www.AerialFacilities.com</small> Technical Literature | 800MHz BDA (Pasadena Figuero Tunnel) Maintenance Handbook | | |
| | H/book Number:- 60-056100HBKM | Issue No:-1 | Date:- 21/10/2003 |

5.7.2 Technical Specification

| PARAMETER | | SPECIFICATION |
|-------------------------------------|--------------|-------------------------------|
| Operating voltage: | | 8 to 30V (floating earth) |
| Alarm Threshold: | | Vcc - 1.20 volt \pm 15% |
| Alarm output relay contacts: | | |
| Max. switch current: | | 1.0Amp |
| Max. switch volts: | | 120Vdc/60VA |
| Max. switch power: | | 24W/60VA |
| Min. switch load: | | 10.0 μ A/10.0mV |
| Relay isolation: | | 1.5kV |
| Mechanical life: | | >2x10 ⁷ operations |
| Relay approval: | | BT type 56 |
| Connector details: | | 15-way 0.1" pitch |
| Temperature range: | operational: | -10°C to +55°C |
| | storage: | -30°C to +70°C |
| PCB Size: | | 74 x 56mm (3 stage) |
| | | 54 x 56mm (1 stage) |

5.7.4 Drg. N^o. 12-002270. 3 Stage Alarm Board Circuit Diagram

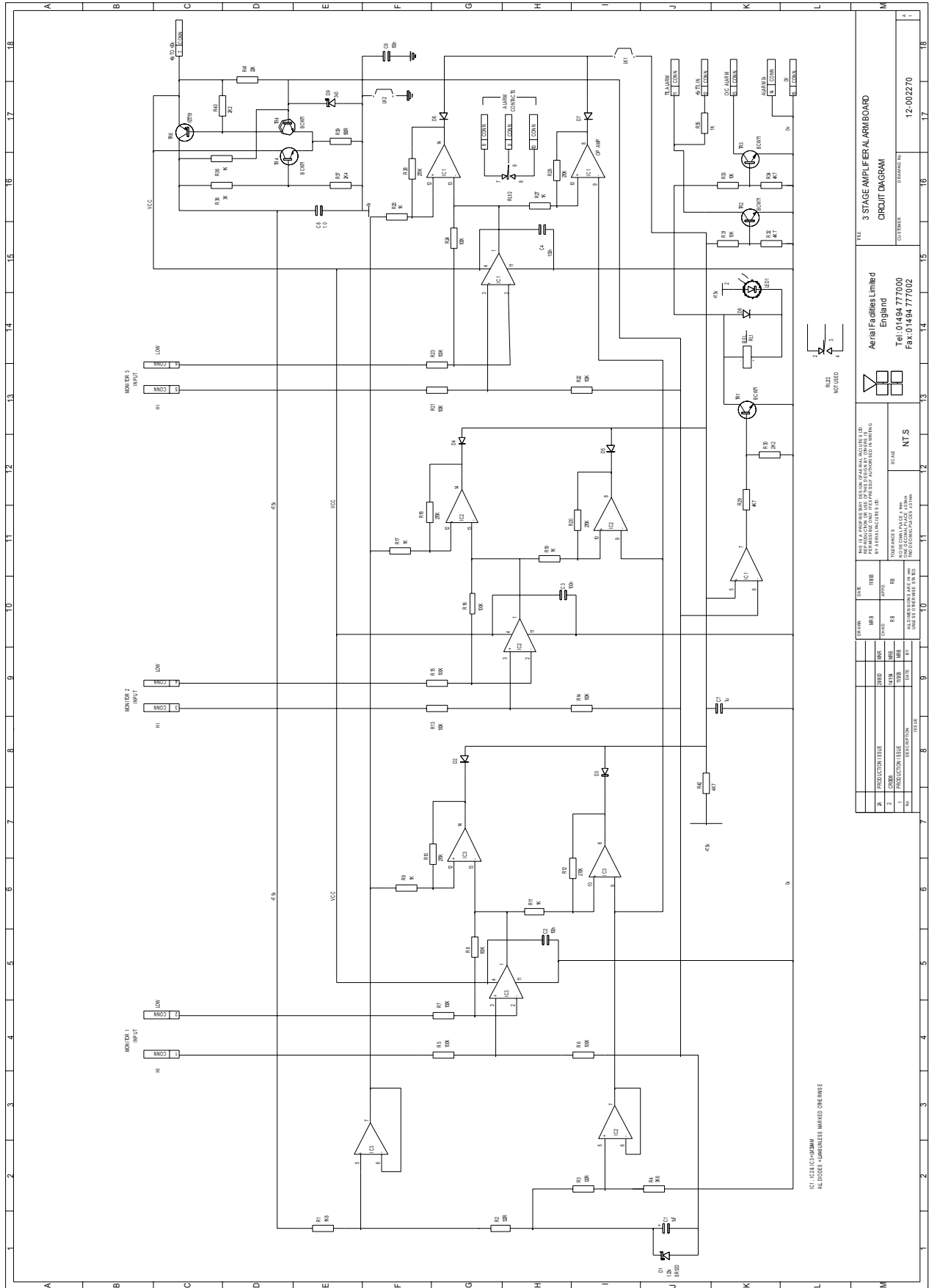

| | | |
|---|-----------------|--------------------------------|
| 3 STAGE AMPLIFIER ALARM BOARD CIRCUIT DIAGRAM | | DRAWING NO 12-002270 |
| Aerial Facilities Limited England Tel: 01454 777000 Fax: 01454 777002 | | |
| DRAWN MFB | CHECKED MFB | DATE 10/08/00 |
| DESIGNED MFB | APPROVED MFB | SCALE N.T.S. |
| ALL DIMENSIONS ARE IN MM UNLESS OTHERWISE STATED UNLESS OTHERWISE STATED | | |
| THIS IS A PROOF COPY OF THE ORIGINAL DRAWING. IT IS NOT TO BE USED FOR FABRICATION OR REPRODUCTION WITHOUT THE WRITTEN PERMISSION OF AERIAL FACILITIES LTD. | | |

5.7.5 Generic Wall Enclosure Alarm Wiring Sketch

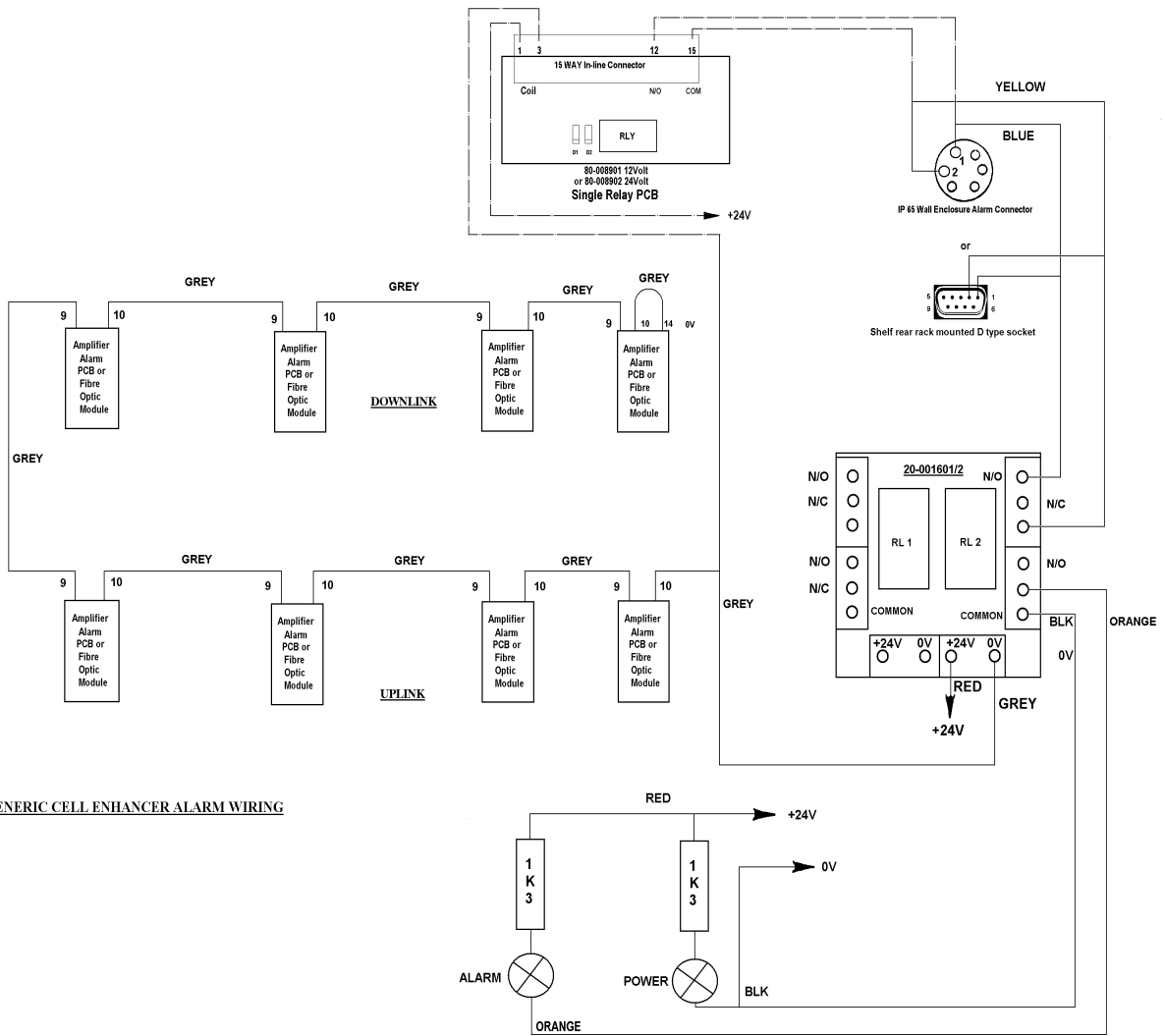

GENERIC CELL ENHANCER ALARM WIRING

5.8 DC/DC Converter, 24V in, 12V 8A out (13-003011)

5.8.1 Description

The DC/DC converter fitted is an AFL assembled, high power PCB unit with an 8 amp @ 12V output capability. The circuit is basically an O.E.M semiconductor regulator (one side of which has a heatsink mounting plate, that is usually bolted to the casing/back panel of a Cell Enhancer) and smoothing components built onto a printed circuit board with screw block terminations.

Note: no circuit diagram of the O.E.M. regulator is available. This unit should not be repaired, only replaced.

5.8.2 Technical Specification

| PARAMETER | | SPECIFICATION |
|----------------------|------------|----------------|
| Input Voltage Range: | | 18-28V DC |
| Output Voltage: | | 12V±0.5V |
| Max. Current Load: | | 8.0Amps |
| Temperature Range: | operation: | -10°C to +55°C |
| | storage: | -30°C to +70°C |
| Size(PCB): | | 190 x 63mm |
| Weight (Loaded PCB): | | 291gm |

5.8.3 Photo of Regulator PCB (regulator heatsink side)

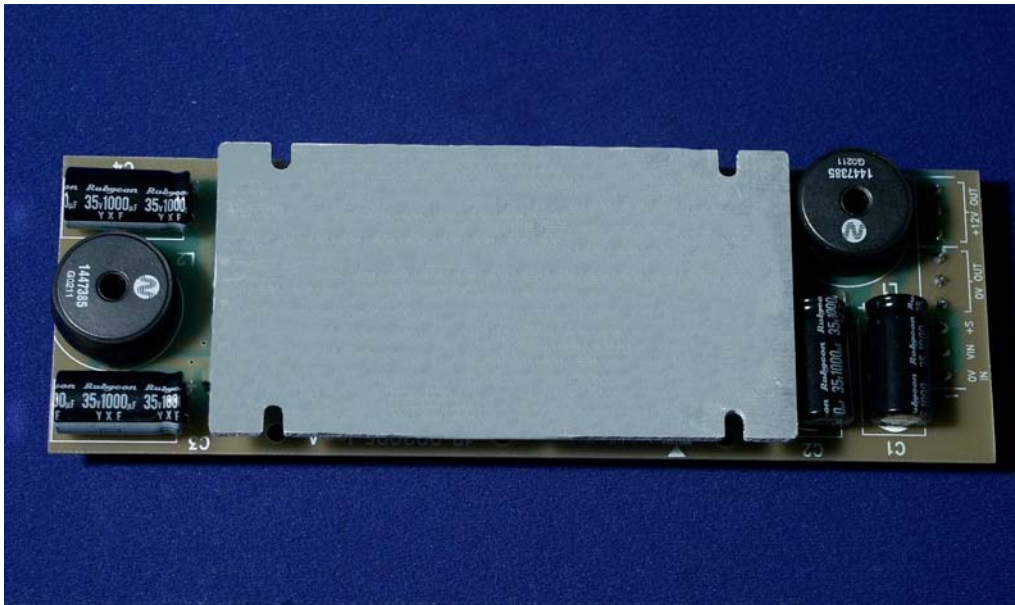

5.9 Channel Control & Channel Selective Modules (17-002101 & 17-009127)

5.9.1 Channel Selective Module Description

The channel selectivity module is employed when the Cell Enhancer requirement dictates that very narrow bandwidths (single operating channels), must be selected from within the operating passband. One channel selectivity module is required for each channel.

The Channel Selectivity Module is an Up/Down frequency converter that mixes the incoming channel frequency with a synthesised local oscillator, so that it is down-converted to an Intermediate Frequency (IF) in the upper HF range. An eight pole crystal filter in the IF amplifier provides the required selectivity to define the operating passband of the Cell Enhancer to a single PMR channel. The same local oscillator then converts the selected IF signal back to the channel frequency.

Selectivity is obtained from a fixed bandwidth block filter operating at an intermediate frequency (IF) in the low VHF range. This filter may be internal to the channel selectivity module (Crystal or SAW filter) or an externally mounted bandpass filter, (LC or Helical Resonator). Various IF bandwidths can therefore be accommodated. A synthesized Local Oscillator is employed in conjunction with high performance frequency mixers, to translate between the signal frequency and IF.

The operating frequency of each channel selectivity module is set by the programming of channel selectivity module frequencies and is achieved digitally, via hard wired links, banks of DIP switches, or via an onboard RS232 control module, providing the ability to remotely set channel frequencies.

Automatic Level Control (ALC) is provided within each channel selectivity module such that the output level is held constant for high level input signals. This feature prevents saturation of the output mixer and of the associated amplifiers.

Alarms within the module inhibit the channel if the synthesised frequency is not locked. The synthesiser will not usually go out of lock unless a frequency far out of band is programmed.

The channel selectivity module is extremely complex and, with the exception of channel frequency programming within the design bandwidth, it cannot be adjusted or repaired without extensive laboratory facilities and the necessary specialised personnel. If a fault is suspected with any channel selectivity module it should be tested by substitution and the complete, suspect module should then be returned to AFL for investigation.

| | | | |
|---|---|-------------|--------------------------|
|  Aerial Facilities Limited www.AerialFacilities.com Technical Literature | 800MHz BDA (Pasadena Figuero Tunnel) Maintenance Handbook | | |
| | H/book Number:- 60-056100HBKM | Issue No:-1 | Date:- 21/10/2003 |
| | | | Page:-40 of 52 |

5.9.2 Drg. N^o. 17-003080, Generic Channel Module Block Diagram

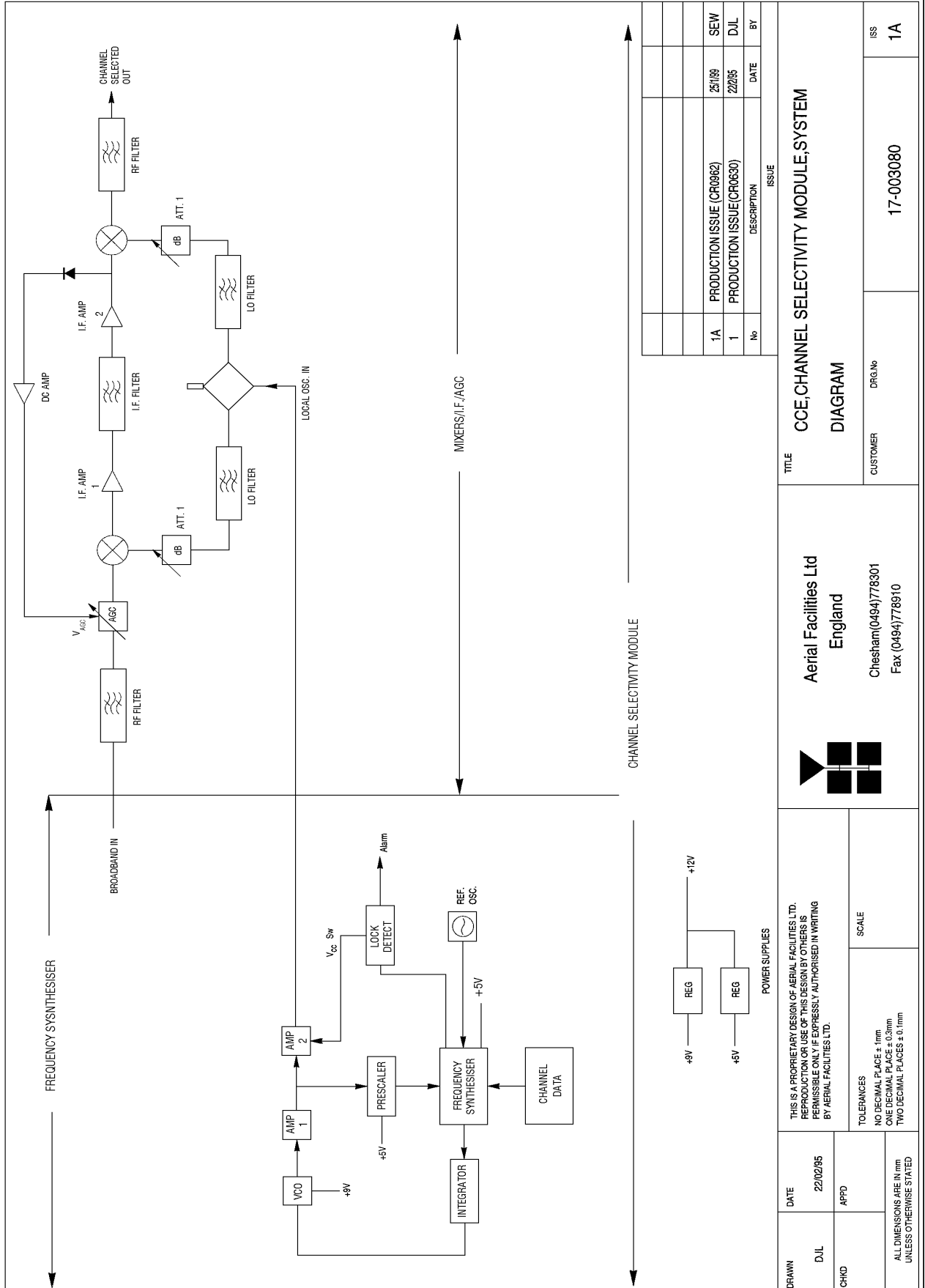

Aerial Facilities Limited
www.AerialFacilities.com
Technical Literature

800MHz BDA (Pasadena Figuero Tunnel)
 Maintenance Handbook

| | | | |
|------------------------------|-------------|------------------|----------------|
| H/book Number:-60-056100HBKM | Issue No:-1 | Date:-21/10/2003 | Page:-41 of 52 |
|------------------------------|-------------|------------------|----------------|

| | | | | | |
|---|--|---|---|--|--|
| | | | | | |
| DRAWN | | DATE | TITLE | | |
| D.J.L | | 22/02/95 | CCE, CHANNEL SELECTIVITY MODULE, SYSTEM | | |
| CHD | | APPD | DIAGRAM | | |
| ALL DIMENSIONS ARE IN mm UNLESS OTHERWISE STATED | | TOLERANCES NO DECIMAL PLACE ± 1mm ONE DECIMAL PLACE ± 0.3mm TWO DECIMAL PLACES ± 0.1mm | CUSTOMER Aerial Facilities Ltd England Chestham(0494)778301 Fax (0494)778910 | | |
| | | SCALE | ISSUE No DESCRIPTION DATE BY | | |
| | | | 17-003080 ISS 1A | | |

5.9.3 Channel Control Module Description

The control module consists of a bank of four, in-line data switches each of which control one channel module frequency setting. One controller unit can therefore control four channel modules. The following list shows the frequencies available for each switch setting.

5.9.4 Channel Controller Frequencies

| IDC PIN | 25-way Connector | Function |
|---------|------------------|-------------------------|
| 1 | 13 | Freq. bit 1 (12.5kHz) |
| 2 | 25 | Freq. bit 2 (25kHz) |
| 3 | 12 | Freq. bit 3 (50kHz) |
| 4 | 24 | Freq. bit 4 (100kHz) |
| 5 | 11 | Freq. bit 5 (200kHz) |
| 6 | 23 | Freq. bit 6 (400kHz) |
| 7 | 10 | Freq. bit 7 (800kHz) |
| 8 | 22 | Freq. bit 8 (1.6MHz) |
| 9 | 9 | Freq. bit 9 (3.2MHz) |
| 10 | 21 | Freq. bit 10 (6.4MHz) |
| 11 | 8 | Freq. bit 11 (12.8MHz) |
| 12 | 20 | Freq. bit 12 (25.6MHz) |
| 13 | 7 | Freq. bit 13 (51.2MHz) |
| 14 | 19 | Freq. bit 14 (102.4MHz) |
| 15 | 6 | Freq. bit 15 (204.8MHz) |
| 16 | 18 | Freq. bit 16 (409.6MHz) |
| 17 | 5 | Module alarm |
| 18 | 17 | Gain bit 1 |
| 19 | 4 | Gain bit 2 |
| 20 | 16 | Gain bit 3 |
| 21 | 3 | Gain bit 4 |
| 22 | 15 | +5V |
| 23 | 2 | 0V |
| 24 | 14 | Switched 12V |
| 25 | 1 | 0V |
| 26 | --- | --- |

5.9.5 Channel Frequency Control Switch Table

| Downlink Frequencies (MHz) | DIP Switch Setting | Uplink Frequencies (MHz) | DIP Switch Setting |
|----------------------------|-----------------------|--------------------------|--------------------|
| 857.7625 | 1,2,3,4,6,8,10,16 | 812.7625 | 2,3,5,7,10,16 |
| 859.9375 | 2,3,9,10,16 | 814.9375 | 1,3,4,6,8,10,16 |
| 859.7625 | 1,2,3,4,5,6,7,8,10,16 | 814.7625 | 2,3,6,8,10,16 |
| 857.9375 | 2,3,5,6,8,10,16 | 812.9375 | 1,3,4,5,7,10,16 |
| 858.2375 | 2,7,8,10,16 | 813.2375 | 1,4,6,7,10,16 |
| 860.4375 | 2,4,5,9,10,16 | 815.4375 | 1,7,8,10,16 |
| 859.4375 | 2,5,6,7,8,10,16 | 814.4375 | 1,4,5,8,10,16 |
| 858.7625 | 1,2,3,5,7,8,10,16 | 813.7625 | 2,3,4,5,6,7,10,16 |

5.10 24V Single Relay Board (80-008902)

5.10.1 Description

The General Purpose Relay Board allows the inversion of signals and the isolation of circuits. It is equipped with a single dual pole change-over relay RL1, with completely isolated wiring, accessed via a 15 way in-line connector.

The relay is provided with polarity protection diodes and diodes for suppressing the transients caused by "flywheel effect" which can destroy switching transistors or induce spikes on neighbouring circuits. It's common use is to amalgamate all the alarm signals into one, volts-free relay contact pair for the main alarm system.

Note that the board is available for different voltages (12 or 24V) depending on the type of relay fitted at RL1.

5.11 24V 400W Flat-Pack Power Supply (96-300011)

5.11.1 Description

The power supply unit is a switched-mode type capable of supplying 24V DC at 16.0Amps continuously. Equipment of this type typically requires approximately 10.0 Amps at 24V DC, so the PSU will be used conservatively ensuring a long operational lifetime.

No routine maintenance of the PSU is required. If a fault is suspected, then the output voltage from the power supply may be measured on its output terminals. This is typically set to 24.5V.

All the PSU's used in AFL Cell Enhancers are capable of operation from either 110 or 220V nominal AC supplies. The line voltage is sensed automatically, so no adjustment or link setting is needed by the operator. No drawings of the PSU are available.

5.11.2 Technical Specification

| AC Input Supply: | |
|--------------------------|--|
| Voltage: | 110 or 220V nominal - 90 to 132 or 180 to 264V (single phase, absolute limits) |
| Frequency: | 47 to 63Hz |
| DC Output Supply: | |
| Voltage: | 24V DC (nominal), 22 to 26V (absolute limits) |
| Current: | 16.0A |
| Temperature range: | operational: -10BC to +55BC |
| | storage: -40BC to +70BC |

6. INSTALLATION

6.1 Initial Installation Record

When this equipment is initially commissioned, please use the equipment set-up record sheet in Appendix A. This will help both the installation personnel and AFL should these figures be needed for future reference or diagnosis.

6.2 General

The size and weight of the wall unit means that it represent a significant health hazard unless it is mechanically installed in the correct manner. In the interests of safety this should be done before any electrical or RF connections are made.

It is important in determining the location of the wall units that space is allowed for access to the front and underneath of the equipment. To enable maintenance to be carried out, the door must be able to fully open. The location must be served with a duct to allow the entry of cables into the unit.

6.3 Electrical Connections

The mains power supply and the alarms are connected through an IP65 connector which should need no further attention once connected. It is recommended that the AC power connection is approved by a qualified electrician, who must satisfy himself that the supply will be the correct voltage and of sufficient capacity.

All electrical and RF connection should be completed and checked prior to power being applied for the first time.

6.4 RF Connections

All RF connections are made to the cable termination, located on the right-hand side of the wall enclosure. Care must be taken to ensure that the correct connections are made with particular attention made to the base station TX/RX ports. In the event that the base transmitter is connected to the RX output of the unit, damage to the equipment may be done if the base station transmitter is then keyed. If the environment where the equipment is installed is deemed to be 'wet' i.e. water seepage through roofs or walls, then suitable methods to seal the RF N type connectors should be used, for example self amalgamating sealant tape.

Ensure that connections are kept clean and are fully tightened.

| | | | |
|---|---|-------------|--------------------------|
|  Aerial Facilities Limited www.AerialFacilities.com Technical Literature | 800MHz BDA (Pasadena Figuero Tunnel) Maintenance Handbook | | |
| | H/book Number:- 60-056100HBKM | Issue No:-1 | Date:- 21/10/2003 |

6.5 Commissioning

Once all connections are made the equipment is ready for commissioning.

To commission the system the test equipment detailed in section 7.2 will be required. Using the system diagrams and the end-to-end test specification, the equipment should be tested to ensure correct operation. Typical RF levels that are not listed in the end-to-end specification, such as input levels are detailed in the whole system diagram in section 4.

On initial power up the system alarm indicators on the door of the equipment should be checked. A red LED illuminated indicates a fault and that particular module must be investigated before proceeding with the commissioning. A green LED illuminates, to indicate that the power supply is connected and valid.

In the event that any part of the system does not function correctly as expected, check all connections to ensure that they are to the correct port, that the interconnecting cables are not faulty and that they are tightened. The majority of commissioning difficulties arise from problems with the interconnecting cables and connectors.

| | | | |
|---|---|-------------|--------------------------|
|  Aerial Facilities Limited www.AerialFacilities.com Technical Literature | 800MHz BDA (Pasadena Figuero Tunnel) Maintenance Handbook | | |
| | H/book Number:- 60-056100HBKM | Issue No:-1 | Date:- 21/10/2003 |

7. MAINTENANCE

7.1 General Procedures

7.1.1 Fault Finding

In the event that the performance of the system is suspect, a methodical and logical approach to the problem will reveal the cause of the difficulty. The System consists of modules within a wall mounted, environmentally protected enclosure.

Transmissions from the main base stations are passed though the system to the mobile radio equipment; this could be a handheld walkie-talkie, mobile telephone or a transceiver in a vehicle. This path is referred to as the downlink. The return signal path from the mobile radio equipment to the base station is referred to as the uplink.

The first operation is to check the (optional) alarms of each of the active units and determine that the power supplies to the equipment are connected and active.

This can be achieved remotely (via CEMS, the digital RS232 Coverage Enhancement Management System, if fitted), or locally with the front door LED's. The green LED on the front door should be illuminated, while the red alarm indicator should be off.

If an Alarm is on, then that individual module must be removed and tested against the original test specification.

The individual amplifier units have a green LED showing through a hole in their piggy-back alarm board (or directly through a hole in the amplifier lid), which is illuminated if the unit is working correctly.

If an amplifier is suspect, check the DC power supply to the unit. If no other fault is apparent use a spectrum analyser to measure the incoming signal level at the input and then after reconnecting the amplifier input, measure the output level. Consult with the system diagram and amplifier specification to determine the expected gain and compare result.

In the event that there are no alarms on and all units appear to be functioning it will be necessary to test the system in a logical manner to confirm correct operation.

| | | | |
|---|---|-------------|--------------------------|
|  Aerial Facilities Limited www.AerialFacilities.com Technical Literature | 800MHz BDA (Pasadena Figuero Tunnel) Maintenance Handbook | | |
| | H/book Number:- 60-056100HBKM | Issue No:-1 | Date:- 21/10/2003 |

7.1.2 Downlink

Confirm that there is a signal at the expected frequency and strength from the base station. If this is not present then the fault may lay outside the system. To confirm this, inject a downlink frequency signal from a known source at the master site BTS input and check for output at the remote site feeder output.

If a signal is not received at the output it will be necessary to follow the downlink path through the system to find a point at which the signal is lost. The expected downlink output for the given input can be found in the end-to-end test specification.

7.1.3 Uplink

Testing the uplink involves a similar procedure to the downlink except that the frequencies used are those transmitted by the mobile equipment.

7.1.4 Fault repair

Once a faulty component has been identified, a decision must be made on the appropriate course to carry out a repair. A competent engineer can quickly remedy typical faults such as faulty connections or cables. The exceptions to this are cable assemblies connecting bandpass filter assemblies that are manufactured to critical lengths to maintain a 50-ohm system. Care should be taken when replacing cables or connectors to ensure that items are of the correct specification. The repair of component modules such as amplifiers, tuned cavities or bandpass filters will not usually be possible in the field, as they frequently require specialist knowledge and test equipment to ensure correct operation. It is recommended that items of this type are replaced with a spare unit and the faulty unit returned to AFL for repair. If spare parts need to be ordered from AFL, be sure to quote the serial number of the Cell Enhancer/Repeater and the serial number [and frequencies] of the module(s) to be replaced.

| | | | |
|---|---|-------------|--------------------------|
|  Aerial Facilities Limited www.AerialFacilities.com Technical Literature | 800MHz BDA (Pasadena Figuero Tunnel) Maintenance Handbook | | |
| | H/book Number:- 60-056100HBKM | Issue No:-1 | Date:- 21/10/2003 |

7.1.5 Checking service

Following the repair of any part of the system it is recommended that a full end-to-end test is carried out in accordance with the test specification and that the coverage is checked by survey.

It is important to bear in mind that the system includes a radiating cable network and base stations that may be faulty or may have been damaged.

7.1.6 Service Support

Advice and assistance with maintaining and servicing this system are available by contacting Aerial Facilities Ltd.

7.2 Tools & Test Equipment

The minimum tools and test equipment needed to successfully service this AFL product are as follows:-

| | |
|----------------------|---|
| Spectrum analyser: | 100kHz to 2GHz (Dynamic range = 90dB). |
| Signal Generator: | 30MHz to 2GHz (-120dBm to 0dBm o/p level). |
| Attenuator: | 20dB, 10W, DC-2GHz, (N male – N female). |
| Test Antenna: | Yagi or dipole for operating frequency. |
| Digital multi-meter: | Universal Volt-Ohm-Amp meter. |
| Test cable x 2: | N male – N male, 2M long RG214. |
| Test cable x 2: | SMA male – N male, 1m long RG223. |
| Hand tools: | Philips #1&2 tip screwdriver. 3mm flat bladed screwdriver. SMA spanner and torque setter. |

| | | | |
|---|---|-------------|--------------------------|
|  Aerial Facilities Limited www.AerialFacilities.com Technical Literature | 800MHz BDA (Pasadena Figuero Tunnel) Maintenance Handbook | | |
| | H/book Number:- 60-056100HBKM | Issue No:-1 | Date:- 21/10/2003 |

7.3 Care of Modules

7.3.1 General Comments

Many of the active modules contain semiconductor devices utilising MOS technology, which can be damaged by electrostatic discharge. Correct handling of such modules is mandatory to ensure their long-term reliability.

To prevent damage to a module, it must be withdrawn/inserted with care. The module may have connectors on its underside, which might not be visible to the service operative.

7.3.2 Module Removal (LNA's, general procedure):

The following *general* rules should be followed to remove a module:

- 1 Remove power to the unit
- 2 Remove all visible connectors (RF, DC & alarm)
- 3 Release module retaining screws.
- 4 Slowly but firmly, pull the module straight out of its position. Take care not to twist/turn the module during withdrawal. (When the module is loose, care may be needed, as there may be concealed connections underneath).

7.3.3 Module Replacement (general):

- 1 Carefully align the module into its location then slowly push the module directly straight into its position, taking care not to twist/turn it during insertion.
- 2 Reconnect all connectors, RF, alarm, power etc.,(concealed connectors may have to be connected first).
- 3 Replace retaining screws (if any).
- 4 Double-check all connections before applying power.

7.3.4 Power Amplifiers

- 1) Remove power to the unit. (Switch off @ mains/battery, or remove DC in connector)
- 2) Remove alarm wires from alarm screw terminal block or disconnect multi-way alarm connector.
- 3) Carefully disconnect the RF input and output coaxial connectors (usually SMA)

If alarm board removal is not required, go to step 5.

- 4) There is (usually) a plate attached to the alarm board which fixes it to the amplifier, remove its retaining screws and the alarm board can be withdrawn from the amplifier in its entirety. On certain types of amplifier the alarm board is not mounted on a dedicated mounting plate; in this case it will have to firstly be removed by unscrewing it from the mounting pillars, in most cases, the pillars will not have to be removed before lifting the amplifier.

| | | | |
|---|---|-------------|--------------------------|
|  Aerial Facilities Limited www.AerialFacilities.com Technical Literature | 800MHz BDA (Pasadena Figuero Tunnel) Maintenance Handbook | | |
| | H/book Number:- 60-056100HBKM | Issue No:-1 | Date:- 21/10/2003 |

- 5) If the amplifier to be removed has a heatsink attached, there may be several different ways it can have been assembled. The most commonly used method, is screws through the front of the heatsink to threaded screw holes (or nuts and bolts), into the amplifier within the main case. If the heatsink is mounted on the rear of the main case (e.g., against a wall in the case of wall mounted enclosures), then the fixing method for the heatsink will be from within the case, (otherwise the enclosure would have to be removed from the wall in order to remove the heatsink).

When the heatsink has been removed, the amplifier may be unscrewed from the main casing by its four corner fixings and gently withdrawn.

Fitting a new power amplifier module will be the exact reverse of the above.

Note: Do not forget to apply fresh heatsink compound to the heatsink/main case joint and also between the amplifier and the main case.

7.3.5 Low Power Amplifier Replacement

- 1 Disconnect the mains power supply and disconnect the 24V dc supply connector for the LPA.
- 2 Disconnect the RF input and output cables from the LPA.
- 3 Disconnect the alarm connector.
- 4 Remove the alarm monitoring wires from (D type connector) pins 9 and 10.
- 5 Remove the LPA module by removing the four retaining screws, replace with a new LPA module and secure it with the screws.
- 6 Connect the RF cables to the LPA input and output connectors. Reconnect the wires to the alarm board connector pins 9 and 10.
- 7 Reconnect the DC supply connector and turn the mains switch on.

Note: Tighten SMA connectors using only a dedicated SMA torque spanner. If SMA connectors are over-tightened, irreparable damage will occur. . Do not use adjustable pliers to loosen/tighten SMA connectors.

Also take care not to drop or knock the module as this can damage (or misalign in the case of tuned passive modules) sensitive internal components. Always store the modules in an environmentally friendly location

7.3.6 Module Transportation:

To maintain the operation, performance and reliability of any module it must be stored and transported correctly. Any module not installed in a whole system must be kept in an anti-static bag or container. These bags or containers are normally identified by being pink or black, and are often marked with an ESD label. Any module sent back to AFL for investigation/repair must be so protected. Please contact AFL's quality department before returning a module.

| | | | |
|---|---|-------------|------------------|
|  Aerial Facilities Limited www.AerialFacilities.com Technical Literature | 800MHz BDA (Pasadena Figuero Tunnel) Maintenance Handbook | | |
| | H/book Number:-60-056100HBKM | Issue No:-1 | Date:-21/10/2003 |

APPENDIX A INITIAL EQUIPMENT SET-UP CALCULATIONS

| GENERAL INFORMATION | | | |
|---------------------|--|----------------------|--|
| Site Name: | | Client Name: | |
| Date: | | AFL Equip. Model Nō. | |

| ANTENNA SYSTEMS | | | | |
|----------------------------|--------------|-------------|----------------|-----------------|
| | Model | Gain | Azimuth | Comments |
| A - Service Antenna | | | | |
| B - Donor Antenna | | | | |
| | Type | Loss | Length | Comments |
| C - Service Feeder | | | | |
| D - Donor Feeder | | | | |

| INITIAL PARAMETERS | |
|---------------------------------------|-----|
| E - CE Output Power | dBm |
| F - Antenna Isolation | dB |
| G - Input signal level from donor BTS | dBm |
| Operating Voltage | V |

| DOWNLINK CALCULATIONS | | |
|--|----------------------|-------|
| Parameter | Comments | Value |
| Input signal level (G) | | dBm |
| CE max. o/p power (E) | | dBm |
| Gain setting | E - G | dB |
| Isolation required | (Gain + 10dB) | dB |
| Service antenna gain (A) | | dB |
| Service antenna feeder loss (C) | | dB |
| Effective radiated power (ERP) | E+A-C | dBm |
| Attenuator setting | CE gain-gain setting | dB |

If the input signal level in the uplink path is known and steady, use the following calculation table to determine the gain setting. If the CE features Automatic Gain Control the attenuator should be set to zero and if not, then the attenuation setting for both uplink and downlink should be similar.

| UPLINK CALCULATIONS | | |
|--|------------------------|-------|
| Parameter | Comments | Value |
| Input signal level | | dBm |
| CE max. o/p power (E) | | dBm |
| Gain setting | | dB |
| Required isolation | | dB |
| Donor antenna gain (B) | | dB |
| Donor antenna feeder loss (D) | | dB |
| Effective radiated power (ERP) | E+B-D | dBm |
| Attenuator setting | (CE gain-gain setting) | dB |