

MBF-40

SMR 900 PS Repeater

High Selectivity Digital Repeater

User Manual – 00141UM Rev. 1.0

The most important thing we build is trust

COBHAM

THIS DOCUMENT IS VALID FOR THE MBF-40 HIGH SELECTIVITY DIGITAL REPEATER
SUPPORTING THE SMR900 BAND



This document is valid for the following models:

Unit	Description	Part Number
MBF SMR 900	MBF SMR 900 37 dBm 110 VAC	MBF-3709-PS-AC
MBF SMR 900	MBF SMR 900 37 dBm 48VDC	MBF-3709-PS-48 VDC

Copyright © 2018 Axell Wireless Limited trading as Cobham Wireless

All rights reserved.

No part of this document may be copied, distributed, transmitted, transcribed, stored in a retrieval system, or translated into any human or computer language without the prior written permission of Axell Wireless Limited trading as Cobham Wireless.

The manufacturer has made every effort to ensure that the instructions contained in this document are adequate and free of errors and omissions. The manufacturer will, if necessary, explain issues which may not be covered by this document. The manufacturer's liability for any errors in the document is limited to the correction of errors and the aforementioned advisory services.

This document has been prepared to be used by professional and properly trained personnel, and the customer assumes full responsibility when using them. The manufacturer welcomes customer comments as part of the process of continual development and improvement of the documentation in the best way possible from the user's viewpoint. Please submit your comments to the nearest Cobham Wireless sales representative.

Contact Information

Headquarters	Axell Wireless trading as Cobham Wireless Aerial House, Asheridge Road Chesham, Buckinghamshire HP5 2QD, United Kingdom Tel: +44 1494 777000 Fax: +44 1494 777002
Commercial inquiries	cw.coverage@cobham.com
Website	www.cobham.com/wireless
Support issues	cw.support@cobham.com
Technical Support Line, English speaking	+44 1494 777 747

About This Manual

This product manual provides the following information:

- Description of the repeater unit
- Procedures for setup, configuration and checking the proper operation of the MBF-40
- Maintenance and troubleshooting procedures

Intended Audience

This Product Manual is intended for experienced technicians and engineers. It is assumed that the customers installing, operating, and maintaining Cobham Wireless Repeaters are familiar with the basic functionality of Repeaters.

Cobham Wireless states in the User Manual that only suitably qualified, professional people should undertake the installation of the product.

By only using suitably qualified, professional personnel to install the device, installation of the antenna can be maintained, ensuring compliance with FCC RF exposure requirements and FCC rule part §90.219(c) – Ensuring that a Type B signal Booster does not exceed the 5 W ERP requirement.

Notice

Confidential - Authorized Customer Use

This document may be used in its complete form only and is solely for the use of Cobham Wireless employees and authorized Cobham Wireless channels or customers. The material herein is proprietary to Cobham Wireless. Any unauthorized reproduction, use or disclosure of any part thereof is strictly prohibited.

All trademarks and registered trademarks are the property of their respective owners.

Disclaimer of Liability

Contents herein are current as of the date of publication. Cobham Wireless reserves the right to change the contents without prior notice. The information furnished by Cobham Wireless in this document is believed to be accurate and reliable. However, Cobham Wireless assumes no responsibility for its use. In no event shall Cobham Wireless be liable for any damage resulting from loss of data, loss of use, or loss of profits and Cobham Wireless further disclaims any and all liability for indirect, incidental, special, consequential or other similes damages. This disclaimer of liability applies to all products, publications and services during and after the warranty period.

Guarantees

- All antennas must be installed with lightning protection. Damage to power modules, as a result of lightning are not covered by the warranty.
- Switching on AC or DC power prior to the connection of antenna cables is regarded as faulty installation procedure and therefore not covered by the Cobham Wireless warranty.
- The repeater box should be closed using the two screws. The screws must be fully tightened. Failure to do so may affect the IP65 compliancy and therefore any warranty.

Exclusive Remedies

The remedies provided herein are the Buyer's sole and exclusive remedies. Cobham Wireless shall not be viable for any direct, incidental, or consequential damages, whether based on contract, tort, or any legal theory.

System Operation

The input / output RF level power level monitoring windows are for indication only and should not be considered a replacement for laboratory test equipment accuracy of measurement of actual signal levels. The error of measurement will be high at low input levels.



System Maintenance

- In the event of a failure Cobham Wireless's support service should be contacted for advice on a possible module replacement or other action to be taken.
- If a shipment of a repeater back to Cobham Wireless is made within the period of guarantee the original packing must be used.
- The system normally operates without any operator intervention or maintenance. If in the unlikely event of any unit failure, the faulty repeater should be replaced. A failed unit can be removed and replaced with a spare while the rest of the system (other repeaters) is still operating. However, the power supply of the failed repeater should be isolated from the power before anything is replaced.
- Component Replacement - None of the modules in the repeater can be replaced without removing the repeater from its mounting and opening the cover of the repeater.
- In the event of a malfunction in the system, the status of the antenna systems as well as the continuity of the cabling should be checked before replacing any modules within the repeater.



Product Disposal

Product Disposal - Disposal of this product must be handled according to all national laws and regulations. For detailed information regarding materials, please refer to Cobham Wireless.

System Batteries

The Repeater contains two types of batteries:

- A battery pack in the power supply unit, consisting of 8X NiMH batteries.
- A button cell CR1216 on the controller board.



CAUTION! Risk of explosion if battery is replaced by an incorrect type. Dispose of used batteries according to local laws and instructions.

Compliance with FCC

NOTE: This repeater can be operated as both a Part 20 and/or Part 90 Class B repeater.



WARNING: This product is a booster and it is the responsibility of the licensee / installer to select the correct cabling and antennas for their particular deployment scenario.

Part 90 Signal boosters **THIS IS A 90.219 CLASS B DEVICE**



WARNING! This is NOT a CONSUMER device. This device is designed for installation by FCC LICENCEES and QUALIFIED INSTALLERS. You must have an FCC LICENCE or express consent of an FCC Licensee to operate this device. You MUST register Class B signal boosters (as defined in 47 CFR 90.219) online at www.fcc.gov/signal-boosters/registration.

Unauthorized use may result in significant forfeiture penalties, including penalties in excess of \$100,000 for each continuing violation.

This repeater must be operated as a Part 90 Class B repeater. The installation procedure must result in the signal booster complying with FCC requirements 90.219(d). In order to meet FCC requirements **90.219(d)**, it may be necessary for the installer to reduce the UL and/or DL output power for certain installations.

Part 20 Signal boosters



WARNING! This is NOT a CONSUMER device. This device is designed for installation by FCC LICENCEES and QUALIFIED INSTALLERS. You must have an FCC LICENCE or express consent of an FCC Licensee to operate this device..

Unauthorized use may result in significant forfeiture penalties, including penalties in excess of \$100,000 for each continuing violation.

FCC Part 15

This device complies with part 15 of the FCC Rules. Operation is subject to the following two conditions:

- A. This device may not cause harmful interference, and
- B. This device must accept any interference received, including interference that may cause undesired operation.

This equipment has been tested and found to comply with the limits for a **Class B** device, pursuant to part 15 of the FCC Rules. These limits are designed to provide reasonable protection against harmful interference when the equipment is operated in a commercial environment. This equipment generates, uses, and can radiate radio frequency energy and, if not installed and used in accordance with the instruction manual, may cause harmful interference to radio communications. Operation of this equipment in a residential area is likely to cause harmful interference in which case the user will be required to correct the interference at their own expense.

Unauthorized Changes to Equipment

Changes or Modifications not expressly approved by the manufacturer responsible for compliance could void the user's authority to operate the equipment.

In-building applications only

One must be aware that FCC regulation mandates that this repeater is to be used only for in-building applications and thus feed passive or active distributed antenna systems (DAS) accordingly.

FCC RF Exposure Limits

This unit complies with FCC RF exposure limits for an uncontrolled environment. This equipment must be installed and operated with a minimum distance of 33 cm between the radiator and any person's body.

Antenna Installation

Installation of an antenna must comply with the FCC RF exposure requirements. The antenna used for this booster must be mounted on a permanent structure.

The FCC regulations mandate that the ERP of type B signal boosters should not exceed 5 W, this is equivalent to 8.2 W EIRP.

Therefore the max antenna gain allowed for this type of signal booster should be limited to the values given by equation 1 (below) for the service antenna.

Equation (1) – Max SERVICE antenna gain
 Maximum service antenna gain (dBi) = 39.1 – (37 dBm - # of antennas in dB – cable losses in dB).

For example:

No. of Antennas	Cable Losses	Max Allowed Antenna Gain
4	3	39.1 - (37-6-3) = 11.1dBi
1	3	39.1- (37-0-3) = 5.1dbi
10	3	39.1- (37-10-3) = 15.1dbi

Compliance with FCC deployment rule regarding the radiation of noise and intermodulation product

Good engineering practice must be used in regard to the signal booster's radiation of intermodulation products and noise. Thus, the gain of the signal booster should be set so that the ERP of the output of intermodulation products from the signal booster should not exceed the level of -30 dBm in 10 kHz measurement bandwidth and noise from the signal booster should not exceed the level of -43 dBm in 10 kHz measurement bandwidth.

In the event that the intermodulation or noise level measured exceeds the aforementioned values, the signal booster gain should be decreased accordingly.

In general, the ERP of noise on a spectrum more than 1 MHz outside of the pass band should not exceed -70 dBm in a 10 kHz measurement bandwidth.

The MBF-900 repeater has a noise level of -43.8 dBm in 10 kHz measurement at 1 MHz spectrum outside the passband of the signal booster, worst case intermodulation products at around -14.9 dBm in a 10 kHz bandwidth and an in-band noise level at around -42.8 dBm in a 10 kHz bandwidth. Therefore, the noise or intermodulation product at the antenna input port should be calculated based on equation (2).

Equation (2) – Input Noise or intermodulation product to service antenna
 Input Noise to service antenna:
 -XX dBm + Service Antenna gain – antenna splitter losses in dB – cable loss in dB

Example: Intermodulation product

Signal booster connected to 10 service antennas with a 100m long ½ inch cable.
 Losses of such a cable with the connectors = ~ 12dB

Assuming 10 service antennas: antenna splitter losses = 11 dB
 Based on equation (2) Input antenna noise (to the antenna) = -14.9-12 -11= -37.9 dBm ERP
 The intermodulation product to the antenna should be -14.9 -12-11= -37.9dbm ERP

Example: In band Noise

Signal booster connected to 10 service antennas with a 100m long ½ inch cable.
Losses of such a cable with the connectors = ~ 12 dB

Assuming 10 service antennas: antenna splitter losses = 11 dB
Based on equation (2) Input antenna noise (to the antenna) = $-42.8 - 12 - 11 = -65.8$ dBm ERP
The in-band input noise to the antenna should be $-42.8 - 12 - 11 = -65.8$ dBm ERP

Example: Out of band noise

Signal booster connected to 10 service antennas with a 100 m long ½ inch cable.
Losses of such a cable with the connectors = ~ 12 dB

Assuming 10 service antennas: antenna splitter losses = 11 dB
Based on equation (2) Input antenna noise (to the antenna) = $-43.8 - 12 - 11 = -66.8$ dBm ERP
The out of-band input noise to the antenna should be $-43.8 - 12 - 11 = -66.8$ dBm ERP

NOTE: In this example there is a need to add an external band pass filter to attenuate the out of band noise by a further 3.2dB 1MHz away from the band edge. If fewer antennas are deployed then additional filtering will be required.

Conclusion:

Good engineering practice requires that in general when the out of band noise measured at the service antenna input is more than -70 dBm per 10 kHz measurement bandwidth, an external band pass filter should be added to attenuate the out of band noise level.

All Cobham Wireless repeaters include high selectivity duplexers and filters to attenuate the out of band noise. Should additional filtering be required, we have a comprehensive range of interference filters which can be supplied upon request.

General Safety Warnings Concerning Use of System

Always observe standard safety precautions during installation, operation and maintenance of this product.

	Throughout this manual, there are "Caution" warnings. "Caution" calls attention to a procedure or practice, which, if ignored, may result in injury or damage to the system, system component or even the user. Do not perform any procedure preceded by a "Caution" until the described conditions are fully understood and met.
Caution labels!	
	To prevent electrical shock when installing or modifying the system power wiring, disconnect the wiring at the power source before working with un insulated wires or terminals.
Danger: Electrical Shock	
	<ul style="list-style-type: none"> o Before installing or replacing any of the equipment, the entire manual should be read and understood. o The user needs to supply the appropriate AC or DC power to the repeater. Incorrect power settings can damage the repeater and may cause injury to the user. o Please be aware that the equipment may, during certain conditions become very warm and can cause minor injuries if handled without any protection, such as gloves.
Caution: Safety to personnel	
	<ul style="list-style-type: none"> o RF radiation, arising from transmitter outputs connected to AWL's equipment, must be considered a safety hazard. o This condition might only occur in the event of cable disconnection, or because a 'spare' output has been left un-terminated. Either of these conditions would impair the system's efficiency. No investigation should be carried out until all RF power sources have been removed. This would always be a wise precaution, despite the severe mismatch between the impedance of an N type connector at 50 ohm, and that of free space at 377 ohm, which would severely compromise the efficient radiation of RF power. Radio frequency burns could also be a hazard, if any RF power carrying components were to be carelessly touched! o Antenna positions should be chosen to comply with requirements (both local & statutory) regarding exposure of personnel to RF radiation. When connected to an antenna, the unit is capable of producing RF field strengths, which may exceed guideline safe values especially if used with antennas having appreciable gain. In this regard the use of directional antennas with backscreens and a strict site rule that personnel must remain behind the screen while the RF power is on, is strongly recommended. o Where the equipment is used near power lines or in association with temporary masts not having lightning protection, the use of a safety earth connected to the case-earthing bolt is strongly advised.
Caution: RF Exposure	
	<ul style="list-style-type: none"> o When installing, replacing or using this product, observe all safety precautions during handling and operation. Failure to comply with the following general safety precautions and with specific precautions described elsewhere in this manual violates the safety standards of the design, manufacture, and intended use of this product. o Changes or modifications not expressly approved by the party responsible for compliance could void the user's authority to operate the equipment. o Cobham Wireless assumes no liability for the customer's failure to comply with these precautions. This entire manual should be read and understood before operating or maintaining the repeater.
Caution: Safety to equipment	
	Access to the unit installation location is restricted to service personnel who have been instructed on the restrictions and the required precautions to be taken.
Warning: Restricted Access Location	



Attention: Electrostatic Sensitivity

- Observe electrostatic precautionary procedures.
- ESD = Electrostatic Discharge Sensitive Device.
- Static electricity can be conducted to the semiconductor chip from the centre pin of the RF input connector, and through the AC connector pins. When unpacking and otherwise handling the repeater, follow ESD precautionary procedures including use of grounded wrist straps, grounded workbench surfaces, and grounded floor mats.



Caution: Class 1 Laser

The repeaters described in this manual are equipped with class 1 lasers, which have been tested to meet IEC / EN 60825-1:2014 standards.

Caution - Un-terminated optical receptacles may emit laser radiation. Exercise caution as follows:

- Use of controls or adjustments or performances of procedures other than those specified herein may result in hazardous radiation exposure
- Do not stare into beam or view with optical instruments. Optical transmitters in the fibre optic converter can send out high energy invisible laser radiation. There is a risk for permanent damage to the eye.
- Always use protective cover on all cables and connectors which are not connected.
- Never look directly into a Fiber cable or a connector.
- Consider that a Fiber can carry transmission in both directions.
- During handling of laser cables or connections, ensure that the source is switched off.
- Regard all open connectors with respect and direct them in a safe direction and never towards a reflecting surface. Reflected laser radiation should be regarded as equally hazardous as direct radiation.



Lifting and other Health and Safety Recommendations

Certain items of Cobham Wireless equipment are heavy and care should be taken when lifting them by hand. Ensure that a suitable number of personnel, appropriate lifting apparatus and appropriate personal protective equipment is used especially when installing Equipment above ground e.g. on a mast or pole and manual handling precautions relevant to items of the weight of the equipment being worked on must be observed at all times when handling, installing or dismantling this equipment.



Periodical Maintenance

In order to maintain proper cooling of the RRUs, is recommended to clean the fins of the RRUs every two years using a damp cloth. If the RRU installation area is dusty or dirty, it is recommended to perform this procedure more often.

Table of Contents

1	INTRODUCTION	1
1.1	Features and Capabilities	2
1.2	ALC	2
1.3	Operating Temperature	3
1.4	MBF-40 Management Web GUI	3
1.5	MBF-40 Basic Interfaces	3
1.5.1	External Interfaces	4
1.5.2	Securing the Unit	4
1.5.3	Internal Interfaces	5
2	INSTALLATION REQUIREMENTS and PROCEDURE	6
2.1	Service Antenna Requirements	6
2.1.1	Required Antenna Information	6
2.1.2	Recommended Antennas	6
2.1.3	Recommended Splitters and Couplers	7
2.1.4	Indoor Installations Service/Mobile Antenna Requirements	7
2.2	Infrastructure and Cabling Considerations	7
2.2.1	RF Cable Installation Guidelines	8
2.2.2	Grounding Wires Requirements	8
2.2.3	Power Requirements	8
2.2.4	F/O Cable Installation Guidelines	9
2.2.5	EMV Protection	10
2.2.6	External Alarm and Relay Considerations	11
2.2.7	Location Criteria	11
2.3	Repeater Installation	12
2.3.1	Unpacking	12
2.3.2	Rack Mount Installation	13
2.3.3	Wall Mount Installation	14
2.3.4	Grounding	20
2.3.5	Fiber Optic Connection	21
2.3.6	Service Antenna Connections	24
2.3.7	Power Connections and Power On	24
2.3.8	Optional - External Alarm and Relay Connections	28
2.3.9	Closing and Securing the Repeater	29
3	GETTING STARTED	30
3.1	Opening a Repeater Session	30
3.1.1	Opening a Direct Local Session	30
3.1.2	Opening an Indirect Session (via the OMU II)	31
3.2	Navigating the Web Interface	32
3.2.1	The Home Screen	32
3.2.2	Menu Options Buttons	33
3.3	Commissioning the Repeater	33
3.3.1	Defining Site Information – MBF-40 Identification	34
3.3.2	MBF-40 Optical Loss Adjustment (OLA)	34
3.3.3	RF Balancing	36
3.3.4	Integration into the AEM	39
3.3.5	What Next?	39
4	DIRECT ACCESS MENU OPTIONS	40
4.1	Overview	40

- 4.2 Configuration Screen Overview 41**
- 4.3 General Parameters..... 42**
 - 4.3.1 Viewing MBF-40 Site Identification and General Information 42
 - 4.3.2 Date & Time 43
 - 4.3.3 Configure External Alarms..... 43
 - 4.3.4 IP Address 44
- 4.4 Remote Communication Setup 45**
 - 4.4.1 TCP/IP and Ethernet..... 45
 - 4.4.2 SNMP Support 46
- 4.5 User Accounts..... 47**
 - 4.5.1 Default User Accounts 47
 - 4.5.2 User Access Levels 48
 - 4.5.3 Change Password 48
- 4.6 Reboot 49**
- 4.7 Axell Shell (Command Line Interface)..... 49**
- 4.8 Attribute Reference 50**
- 5 MONITORING AND FAULT SOURCING 51**
 - 5.1 Monitoring Via the MBF-40 Home Screen..... 52**
 - 5.1.1 General Page Area 53
 - 5.1.2 Detailed view of the MBF-40..... 53
 - 5.1.3 Detailed view of Fiber Optic Unit 55
 - 5.1.4 Subsystems 55
 - 5.2 Logs Screen 56**
 - 5.3 Module LEDs..... 57**
 - 5.3.1 Control Module LEDs 58
 - 5.3.2 F/O Converter LEDs 58
 - 5.3.3 Power Supply LEDs 59
- 6 MAINTENANCE 60**
 - 6.1 Cautions and General Statements 60**
 - 6.2 Batteries..... 60**
- APPENDIX A – SPECIFICATIONS 61**
- APPENDIX B – F/O CLEANING PROCEDURE 62**

1 INTRODUCTION

MBF-40 SMR 900 repeater is an optic fed system that encapsulates solutions for single or multi-operator use. It offers seamless coverage in any indoor environment such as tunnels, subways and large buildings. Signals are coupled off from a nearby base station using an optical master unit (OMU) and then distributed via fiber to one or more MBF-40 repeaters.

The MBF-40's high output power allows for greater coverage whilst deploying fewer units. Even though providing high output power, the MBF-40 uses convection cooling, subsequently increasing the repeater's MTBF.

These remote units can be installed at a distance of up to 20 km from the base station site, offering great flexibility when providing RF coverage in areas where off air transmission is not a preferable solution.

A distributed antenna system (DAS) can be used to distribute the signal throughout the area to be covered. Cobham Wireless can provide a complete solution including design, site surveys and equipment related to the point of interface (POI) such as combiners, filters, cross band couplers, etc.

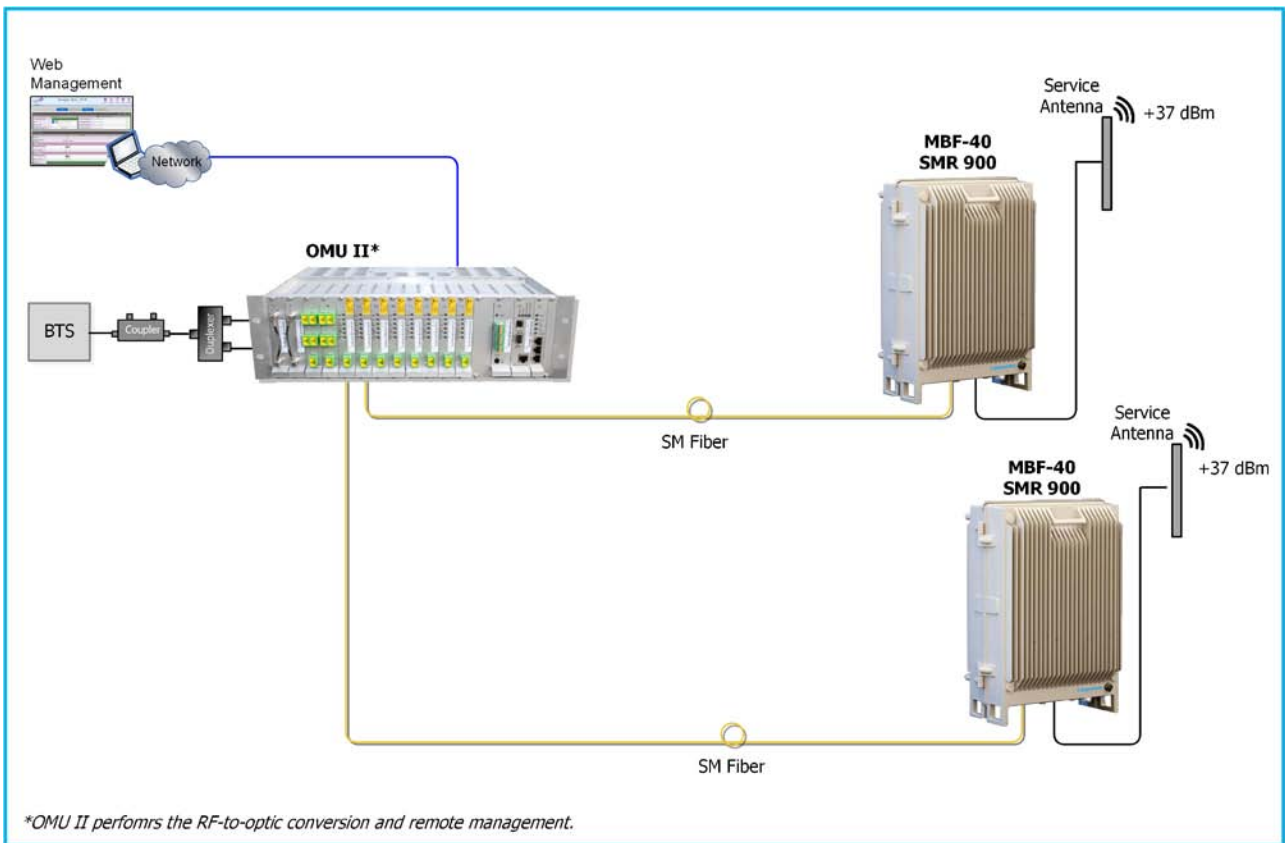

Figure 1-1. Illustration of a standard OMU II MBF Remote Application

1.1 Features and Capabilities

- High-power indoor unit supporting SMR 900 MHz
- Output power at the antenna (composite): 37 dBm
- Very low noise factor — minimizes interference to BTS and increases high speed data throughput
- Remote commissioning and monitoring:
 - Via OMU II intuitive Web GUI
 - SNMP v1/v2c support
- Plug-and-Play — automatic detection and optical gain setting via the OMU
- Automatic level control (ALC) — provides constant gain in both uplink and downlink paths according to the defined maximum output level
- Backup battery for 'last gasp' indication (sending fault error before power failure)
- Power source: 115 VAC or -48 V power (model dependent)

1.2 ALC

The repeater has a constant gain in both uplink and downlink paths. The repeater has a defined maximum output level. If the input signal amplified by the gain set exceeds the set output limit, an automatic level control (ALC) loop is activated. This ALC ensures that the amplifier does not add distortion to the radio signal. Below are examples of the ALC function for one and two carriers.

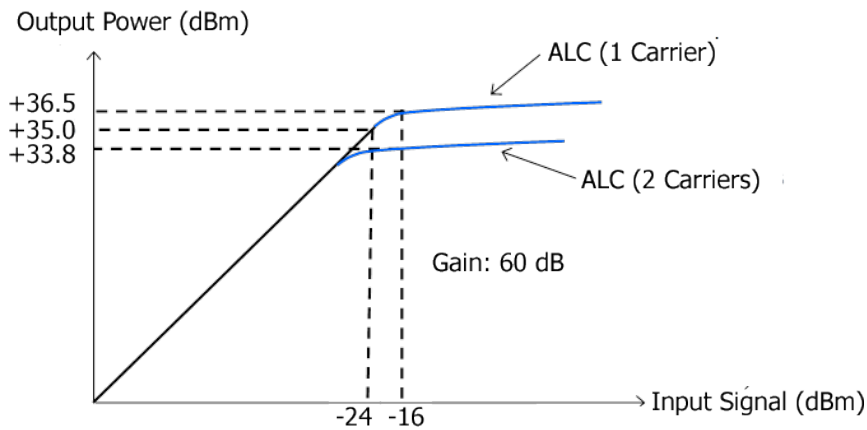

Figure 1-2. Example of ALC for One and Two Carriers

1.3 Operating Temperature

The MBF-40 is designed primarily for multi carrier purposes. If the repeater is run at full output power over a long period of time, additional, external cooling may be required; this can take the form of air-conditioning or an external fan assembly.

NOTE: The repeater is equipped with a power management function that steps down the power and, if needed, fully shuts down the amplifier chains until temperature reaches normal values.

1.4 MBF-40 Management Web GUI

MBF-40 is remotely commissioned and monitored via an OMUII session. Local access to the unit is not required for commissioning.

Additional configuration and troubleshooting options are available via a direct connection to the MBF-40 IP address. A direct session can be opened locally or remotely.

NOTE: Direct remote communication requires connecting the MBF-40 to an Ethernet network.

1.5 MBF-40 Basic Interfaces

The MBF unit provides several types of interfaces:

- Lock and screws for protection and security
- External service antenna and GND connections
- Internal connections for power, Fiber optics and alarm cables routed via openings in the front panel.
- Internal USB and Ethernet connections for local setup via web GUI

1.5.1 External Interfaces

NOTE: The external connections at the bottom of the repeater can be protected with a cover which is screwed in place.

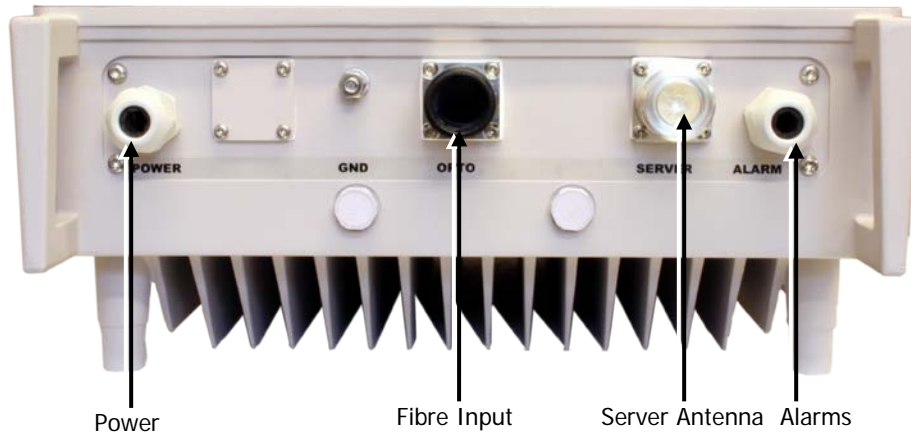

Figure 1-3. External Interfaces

Port	Description
Server	Service antenna connection — DIN 7/16" connector, female
Optic	SC/APC Fiber optic inlet through which the optic fibre is routed for internal connections (Section 2.3.5).
Power	Plinth connection for routing power for internal connection (Section 2.3.7.1)
Alarms	Plinth connector for routing external alarms and relay wiring cable for internal connections (Section 0).
GND	Grounding lug (Section 2.3.3)

1.5.2 Securing the Unit

The repeaters are secured with two hex screws (M8) and can also be locked with a key.

NOTE: The two screws must be fully tightened. Failure to do so may affect the IP65 compliancy and therefore any warranty.

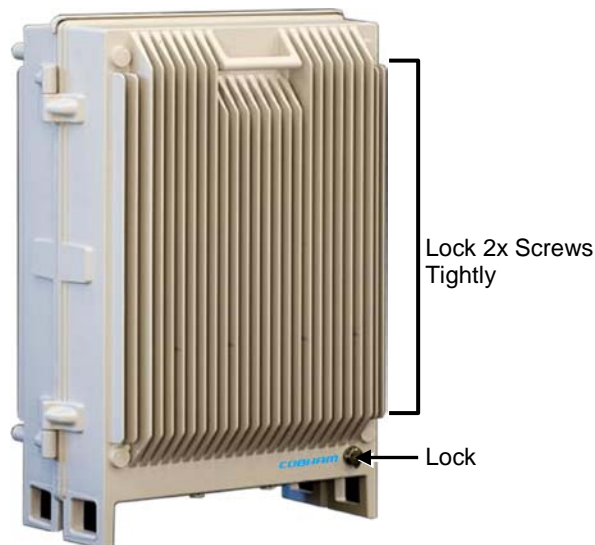

Figure 1-4. Securing Repeater

1.5.3 Internal Interfaces

This section shows the internal interfaces relevant to the following operations:

- Connect power
- Connect optic fibres
- Connect alarms (if relevant)
- Power-on (power-on switch)
- Optional — USB/Ethernet port for local setup

NOTE: The internal view of your repeater may be different, but the general location of the relevant items is the same.

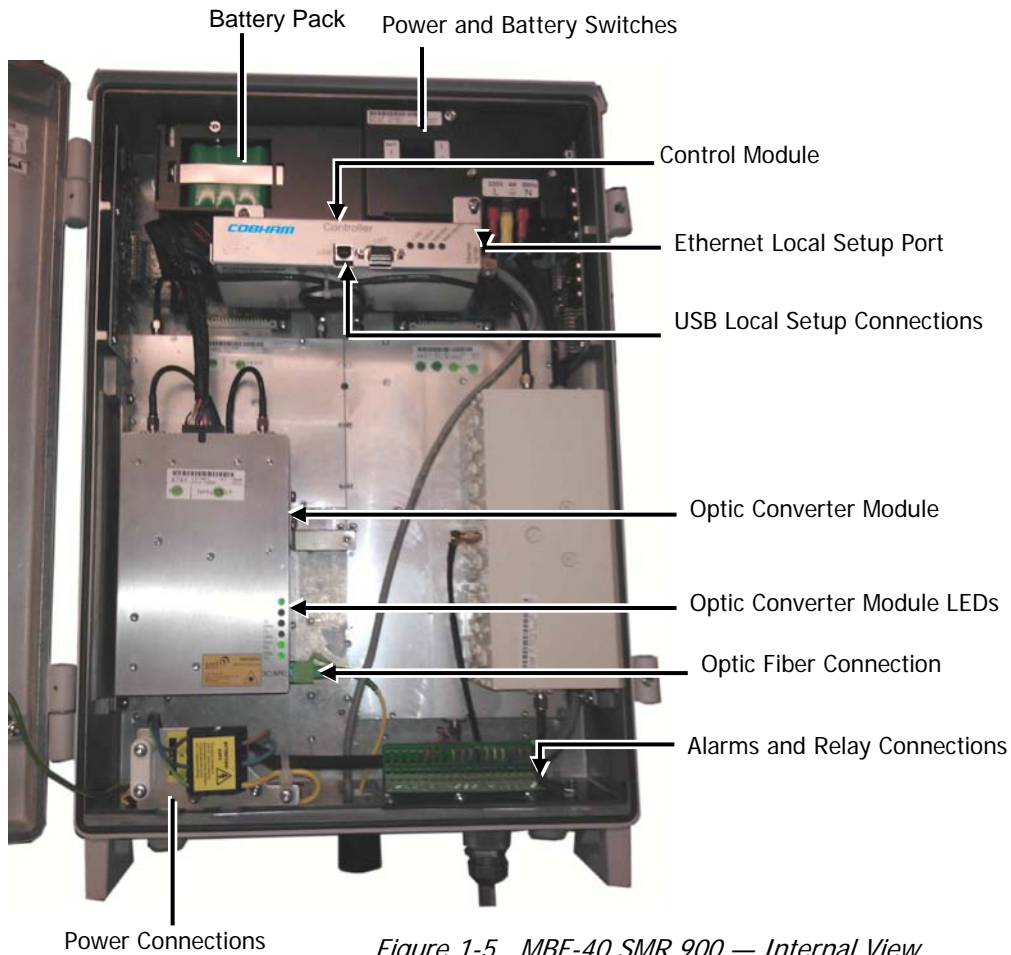

Figure 1-5. MBF-40 SMR 900 — Internal View

2 INSTALLATION REQUIREMENTS AND PROCEDURE

This chapter provides information on the service antenna requirements, general installation requirements and the installation procedure.

2.1 Service Antenna Requirements



ATTENTION!

- The installer is held accountable for implementing the rules required for deployment.
- Good engineering practice must be used to avoid interference.
- Output power should be reduced to solve any IMD interference issues

This section provides information on the specifications of the service antennas suitable for operation with this repeater, on the installation requirements of the antennas and on the Repeater installation site and cable requirements.

2.1.1 Required Antenna Information

The following antenna requirements, specifications and site considerations should be met.

- Type of installation – indoor
- Service area type and size
- Antenna type and characteristics
- Height
- Length and type of coaxial cable required for connecting the Service antenna to the remote and the attenuation.

2.1.2 Recommended Antennas

The Service antenna is installed indoors, where the type of antenna depends on the application.

Specifications:

- One or a combination of the following antennas can be used: Ceiling-mount patch antenna, wallmount patch antenna, corner reflector.
- Choose an antenna with high side lobe attenuation which enables maximum isolation from other service/mobile antennas.

Equation (1) – Max service antenna gain

$$\text{Maximum service antenna gain (dBi)} = 39.1 - (37 \text{ dBm} - \# \text{ of antennas in dB} - \text{cable losses in dB}).$$

For example:

No. of Antennas	Cable Losses	Max Allowed Antenna Gain
4	3	39.1 - (37-6-3) = 11.1dBi
1	3	39.1- (37-0-3) = 5.1dbi
10	3	39.1- (37-10-3) = 15.1dbi

Typical antenna types:

- Indoor dome 2.1 dBi; beam width 360°
- Indoor panel 4.2 dBi; beam width 106°
- Radiating cable typically < -50 dBi

2.1.3 Recommended Splitters and Couplers

Recommended Splitters

Splitter part numbers	90 - 851102	90 - 851103	90 - 851104
Frequency band	700 – 2700 MHz	700 – 2700 MHz	700 – 2700 MHz
Split	2 way	3 way	4 way
Max Insertion Loss	0.4 dB	0.6 dB	0.6 dB
Split Loss	3 dB	4.8 dB	6 dB

Recommended Couplers

Coupler part numbers	90 - 852206	90 - 852210	90 - 852215	90 - 852220
Frequency band	700-2700 MHz	700–2700 MHz	700–2700 MHz	700–2700 MHz
Coupling	-6 dB ±0.8 dB	-10 dB ±1.0 dB	-15 dB ±1.0 dB	-20 dB ±1.0 dB
Max Mainline Loss	1.7 dB	0.8 dB	0.4 dB	0.22 dB

2.1.4 Indoor Installations Service/Mobile Antenna Requirements

Determine the antenna installation configuration, according to the transmission requirements and the installation site conditions.

Installation requirements:

- An indoor antenna should be installed at a convenient location. It should be free of metallic obstruction.
- Install the service antenna at the designated height and tune it roughly toward the service coverage area.

2.2 Infrastructure and Cabling Considerations

This section includes the following information:

- RF and grounding cabling guidelines
- Power requirements
- F/O installation guidelines
- EMV protection requirements
- External alarm and relay considerations
- Criteria for selecting the repeater location

2.2.1 RF Cable Installation Guidelines

- For all coaxial connections to/from the Repeater – use high performance, low-loss, 50 ohm coaxial communication cables.
- All cables shall be weather-resistant type.
- Cable length – determined by the Repeater installation plan. When calculating the cable length, take into account excess cable slack so as not to limit the insertion paths.
- Make sure the cable and the connector are compatible. Using cables and connectors from the same manufacturer is helpful.
- All connectors must be clean and dry.
- Make sure enough room has been allocated for the bending radius of the cable. RF cables must not be kinked, cut or damaged in any way.
- Connect the RF cable to the antenna tightly but without damaging threads.
- Fasten cable tightly to cable ladder or aluminium sheet.
- For short length feeder cables, use 1/2-in; for longer feeder cables, use 7/8-in. Choose thicker coax cables for lower attenuation. Minimize the length of the coax cables to reduce attenuation.
- Use jumper cable for easy installation. The RF coaxial cable can be substituted at each end with a jumper cable.

2.2.2 Grounding Wires Requirements



WARNING! Do not use the repeater grounding bolt to connect external devices.

Requirements for grounding wires

- Ensure that good grounding protection measures are taken to create a reliable repeater site.
- Make sure to use adequately dimensioned grounding cables. The minimum recommended conductive area for a grounding cable is 16 mm²
- Make sure the grounding product used is suitable for the type and size of used cable.
- Connect the repeater box bolt to the same ground.

2.2.3 Power Requirements

This section describes the circuit breaker requirements and power cabling and connection considerations for 230 VAC power source and for -48 VDC power sources.

2.2.3.1 Circuit Breaker Requirements

The power connections to the unit are hard-wired. To disconnect the unit (either manually or automatically in case of overcurrent), it is required to install a circuit breaker on the wall near the unit, at an easily accessible distance and location from the unit.

Circuit-breaker minimum requirements

- 115 VAC — maximum current 10A
- Needs to be safety approved
- Use only a two-pole disconnect device.
- Requires minimum contact separation of 3mm.
- Install on the wall near the unit.

2.2.3.2 115 VAC Power Source Cable Requirements

Cable requirements:

- Cable should be NRTL (safety) approved with a minimum of 14 AWG or 2.5 mm² per conductor, and maximum of 12 AWG or 4 mm² per conductor.
- For safety, the GND cable must be 10 mm longer than the phase and neutral cables.

2.2.3.3 -48 V Power Source Connection Requirements

NOTE: The -48 VDC version of the power supply is designed to turn off if the supply voltage falls below -36 V (±1V), not to drain the feeding battery. It will turn on again as the supply voltage reaches -43 V (± 1V).

-48 V power supply requirements



The 48VDC power supply must comply with SELV requirements, as defined in EN60950, which implies double isolation. The output power needs to be 48 VDC +25%/-15%. The maximum input current is 8 A.

Recommended cable areas for 48 VDC

Distance	Cable Area
0-10 meters between repeater and power supply	2.5 mm ²
10-50 meters between repeater and power supply	4 mm ²
Over 50 meters between repeater and power supply	Recommendation is to reconfigure the installation, or to make special arrangements to increase cable area

2.2.4 F/O Cable Installation Guidelines

This product is equipped with **Class 1 Lasers**, as per definition in EN 60825-1.

 	<p>CAUTION!</p> <p>Un-terminated optical receptacles may emit laser radiation. Do not stare into beam or view with optical instruments.</p>
---	--

	<p>WARNINGS!</p> <ul style="list-style-type: none"> ○ Maximum input power should not exceed (zero) 0 dBm ○ Clean the fibre connectors (receptacles and cables) before connecting. See APPENDIX B – F/O CLEANING PROCEDURE for details on F/O cleaning procedures.
---	--

Note the following:

- This procedure requires opening the repeater.
- Use angled APC connectors at 8 deg angle over the complete link between the Repeater and OMU
- Use APC type ODF connections
- Required Fibre cable: single mode 9/125
- Cable length — determined by the Remote installation plan. When calculating the cable length, take into account excess cable slack so as not to limit the insertion paths.

2.2.5 EMV Protection



CAUTION! Ensure good EMV protection. If insufficient Electromagnetic Protection is provided, or if EMV measures are not taken, warranties issued by Cobham Wireless are not valid.

Connect the lightning protection

The lightning hazard to electric and electronic equipment consists in the interferences of direct lightning current infections and high surge voltages induced by the electromagnetic field of nearby lightning channels or down conductors. Amplitudes from cloud-to-earth lightning amounts to several 10 kA and may last longer than 2 ms. The damage caused depends on the energy involved and on the sensitivity of the electronics systems.

Ensure that lightning protection measures are taken to create a reliable repeater site. Protect all coaxial cables and power cables from the transients caused by lightning. Fit all cables with suitable lightning protection devices.

The primary protective device is part of the site installation and is not supplied by Cobham Wireless. Coaxial lightning protection is normally one of these three types: gas capsule, high-pass and Bandpass.

There also need to be a protective device installed on the power supply cord.

Several lightning protection devices should be used in series with declining threshold voltages to help attenuate the pulse component which makes it through the first layer of protection.

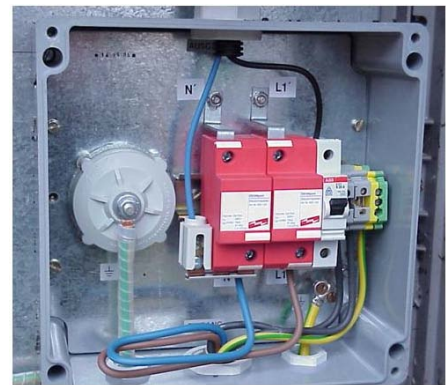

Figure 2-1. Protective Device Installed in Connection with the Power Supply

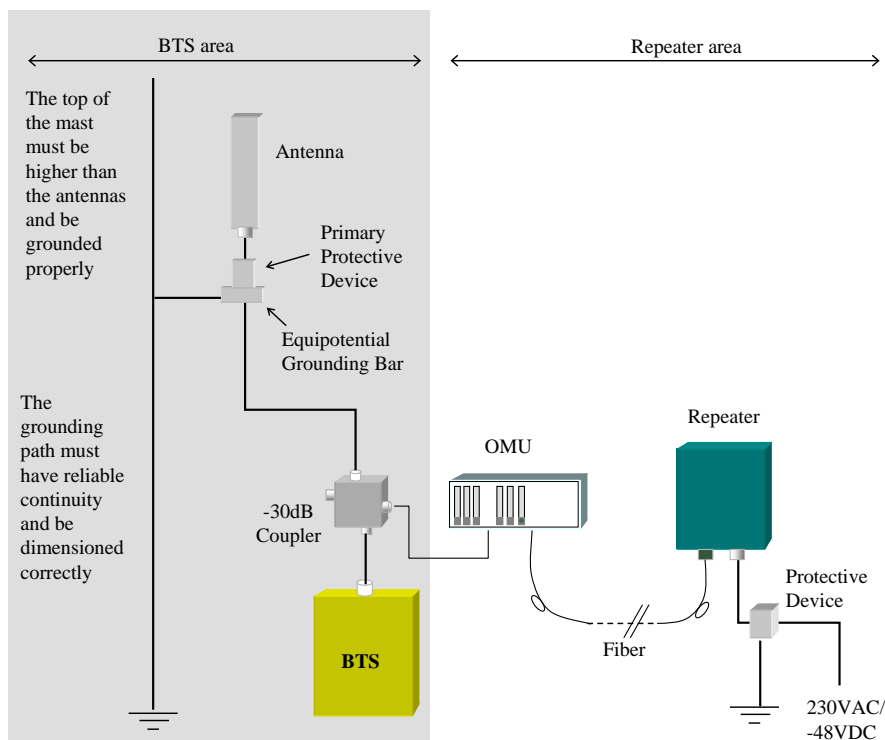

Figure 2-2. Example of EMV protection for a repeater system

For detailed information please refer to IEC 61024-1 and 61312-1 for international standards for protection of information systems against LEMP (Lightning Electromagnetic Pulse), including radio transmitters. They define proper planning, installation and inspection of effective lightning protection systems.

Cobham Wireless repeaters comply with the EN standard ETS 301 498-8 which stipulates demands on lightning/surge protection for typical infrastructure telecom equipment installations.

2.2.6 External Alarm and Relay Considerations

For installations that include connections of external alarms and relays

- The connector plinth for the external alarms is located inside the repeater.
- The strain relief fitting in is a Pg 13.5 suitable for a 6-12 mm cable diameter.
- Four external alarm sources can be connected to the repeater.
- Alarm operating voltage: between 12 and 24 VDC.
- The relay supplies 100mA maximum current

2.2.7 Location Criteria

Location criteria

- **For wall mount installations:**
 - **Wall compatibility** - check the suitability of the wall on which the unit is to be fitted.
 - **Plan mount** - check the actual fixing centers (see below) and overall dimensions of the unit enclosure. The unit is supplied with two wall mounting brackets; when the unit is mounted on these brackets adequate ventilation is provided between the unit and the wall to which it is fixed.
- **Plan connection cable clearances** — the optical, RF and power connections located on the underside of the unit will need at least 300 mm vertical clearance below the unit to enable the connections to be made. The minimum bend radius for optical and RF cables must not be less than the recommendations made by the cable manufacturer. Plan the cable runs and ensure adequate space is available.
- **Allow for door opening** — ensure that there is sufficient space at the front of the unit to allow the door to be fully opened and for maintenance engineers to get access to the unit with test equipment such as a spectrum analyzer. Allow an additional 500 mm of space in front of the unit when the door is fully open.
- **Allow for heat dispersion** — mount the repeater so that heat can be dispersed from it.

The repeater wall mounting kit ensures an optimum airflow between the wall and the repeater.) Do not block this air channel as it will cause the MTBF of the repeater to drop dramatically, or even in the worst case cause the repeater to fail completely.

2.3 Repeater Installation

2.3.1 Unpacking

Upon receiving the MBF-40 Repeater perform the following:

1. Examine the shipping container for damage before unpacking the unit.
2. Perform a visual inspection to reveal any physical damage to the equipment.
3. Verify that all of the equipment (listed below) is included. Otherwise contact Cobham Wireless.
 The MBF-40 Repeater is shipped with the following equipment:

Package Contents

USB containing User's Manual and USB driver														
Mounting Brackets														
Additional (supplied) installation components:	<table border="1" style="width: 100%; border-collapse: collapse;"> <thead> <tr style="background-color: #cccccc;"> <th style="width: 15%;">Qty.</th> <th>Description</th> </tr> </thead> <tbody> <tr> <td>4x</td> <td>M8x12 bolts for securing the Repeater to the brackets</td> </tr> <tr> <td>1x</td> <td>Insex tool for bolts</td> </tr> <tr> <td>1x</td> <td>Power Cable</td> </tr> <tr> <td>1x</td> <td>Fiber Conduit inlet hose fitter (may be pre-assembled)</td> </tr> <tr> <td>2 x</td> <td>Sets of keys</td> </tr> </tbody> </table>		Qty.	Description	4x	M8x12 bolts for securing the Repeater to the brackets	1x	Insex tool for bolts	1x	Power Cable	1x	Fiber Conduit inlet hose fitter (may be pre-assembled)	2 x	Sets of keys
Qty.	Description													
4x	M8x12 bolts for securing the Repeater to the brackets													
1x	Insex tool for bolts													
1x	Power Cable													
1x	Fiber Conduit inlet hose fitter (may be pre-assembled)													
2 x	Sets of keys													
Optional equipment	AC Cable [30 ft.] – Long cable for AC power Alarm Cable [30 ft.] – Long cable for External Alarms Input													

2.3.2 Rack Mount Installation

The supplied brackets are used to mount the repeater either on a wall or in a 19" rack. The same brackets are used for both medium and high-power repeaters.

	<p>IMPORTANT!</p> <ul style="list-style-type: none"> • The weight of the unit requires that two people mount the unit onto the rack. • The signal booster must always be installed vertically with the connectors on the underside for protection. Horizontal installation on a bench for long time may cause damage to the signal booster due to over-heating.
---	--

To mount the repeater in a rack

1. Use the x4 (provided) M8 fixing bolts and X4 spring washers to assemble the brackets as illustrated below.



Figure 2-3. Rack-Mount Bracket Position

2. Mount the repeater vertically in the rack, while adhering to standard rack mounting procedures, and secure.

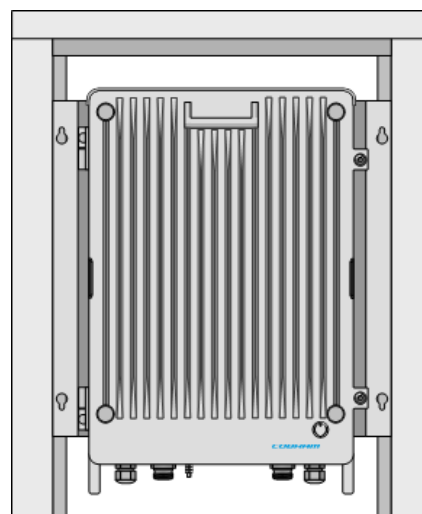



Figure 2-4. Rack-Mount Repeater Position

2.3.3 Wall Mount Installation



IMPORTANT!

- The repeater mounting procedure is for concrete or brick walls only.
- The weight of the unit requires that two people mount the unit on the wall.
- The signal booster must always be installed vertically with the connectors on the underside for protection. Horizontal installation on a bench for long time may cause damage to the signal booster due to over-heating.

2.3.3.1 Wall Mount Bracket Assembly

NOTE: In addition to the mounting brackets, it is recommended to use additional fixings as described in Section 2.3.3.4.

To assemble the brackets

Assemble the brackets to the repeater using the supplied 4 x M8 bolts and spring washers as shown in the following figure.

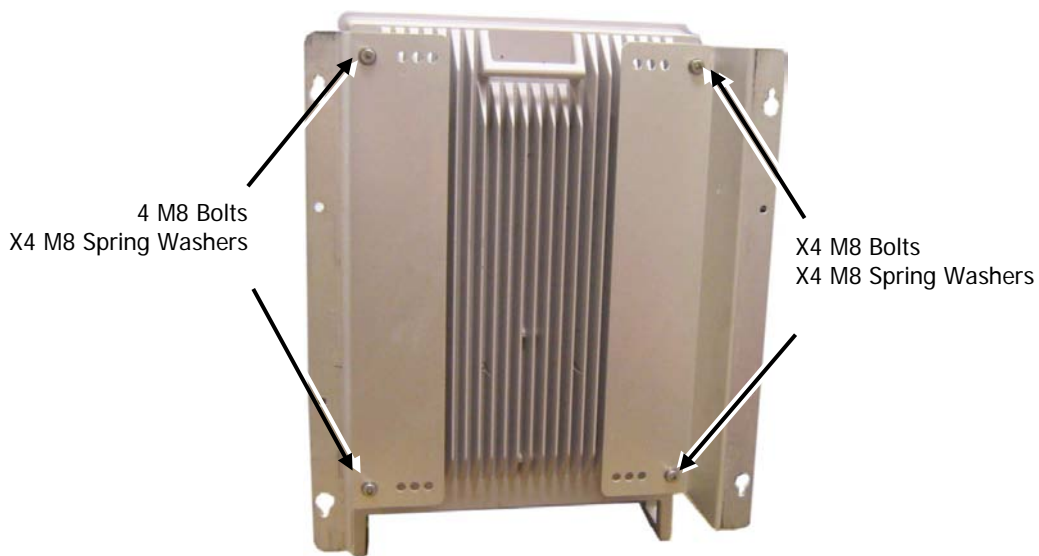



Figure 2-5. Position of Brackets for Wallmount

2.3.3.2 Wall Marking and Drilling

	<p>WARNINGS!</p> <ul style="list-style-type: none"> • Due to the weight of the repeater, it is not recommended to fix to a hollow wall). • The repeater wall mount brackets assembly should be fixed to a solid wall (these include brickwork, block work, and concrete). • Always check that there are no pipes or cables hidden in the wall beneath the area to be drilled. Various pipe and cable detectors are available for this type of inspection.
---	---

- To provide secure fixing to a solid wall, the most common method is drilling and plugging. The size of fixing is dependent on the item to be fixed and the nature of the wall, The Repeater should be fixed with mild steel, M6 (50 mm to 75 mm) rawlbolts or similar.
- Care must be taken to ensure the alignment of the four fixings. A spirit level or plumb line should be used to ensure horizontal/vertical alignment.

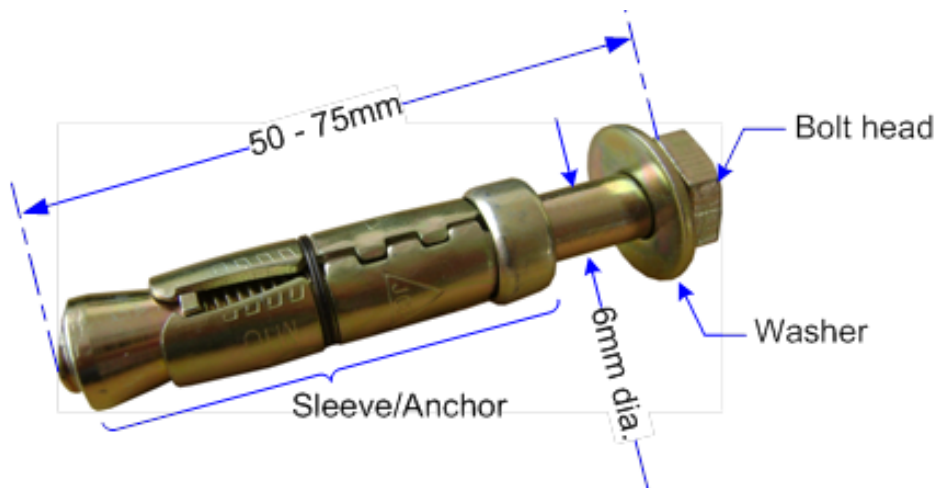

Figure 2-6. M6 Rawlbolt — Recommended for Wallmount

To mark and drill the wall

- Using the provided *drill template*, mark out the fixing centers of the repeater on the chosen wall. The repeater dimensions are shown below.

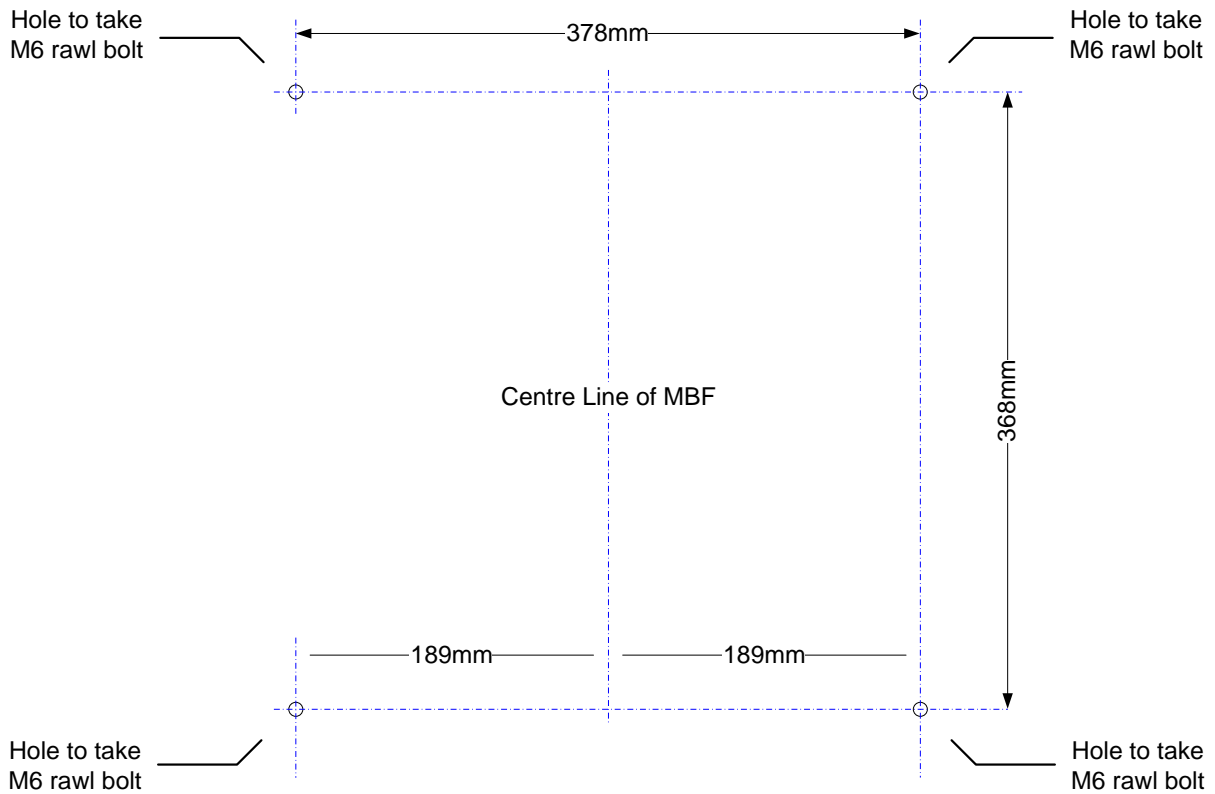

Figure 2-7. Fixing Centers

- Mark and drill the wall with the correct size masonry bit as specified by the fixing manufacturer.
NOTE: It is good practice to wear goggles to protect your eyes from flying debris when using power tools.
- Hold the drill bit against the mark and begin drilling slowly so that the bit does not wander from the position. The wall should be drilled to a depth which is sufficient to accommodate the full length of the fixing.
- Insert the fixings so that the top of the sleeve/anchor section is level with the wall surface.
- Gently tighten the bolt by hand so that the anchor section of the fixing expands and grips the inside of the hole.

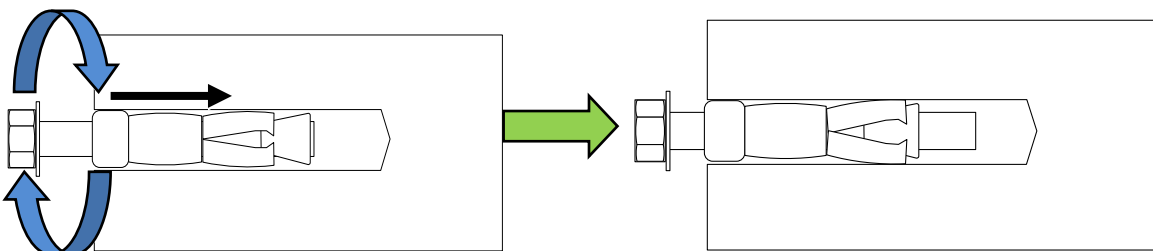

Figure 2-8. Inserting Fixing and Tightening

- As the bolt pulls its way in, the sides of the anchor section are forced outwards, gripping the surrounding surface.

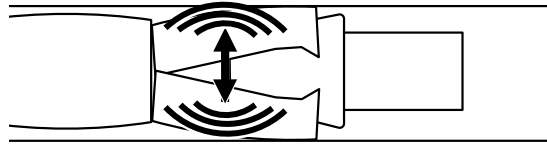

Figure 2-9. Anchor Sides Pushed Outwards.

- Once all four fixings are in place, carefully withdraw the four bolts.

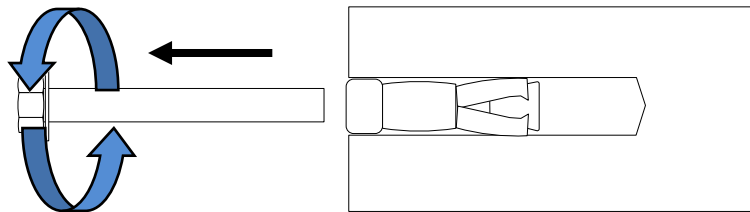

Figure 2-10. Withdraw Bolts

2.3.3.3 Mount the Repeater



CAUTION! It is recommended that two people lift the repeater since (depending upon the configuration) the repeater weighs between 20 and 38 kg (44 and 84 lb)

To mount the repeater

- Align repeater with the four fixings. Great care should be exercised here as the repeater is very heavy. (A suitably rated heavy duty scissor lift table/trolley may be suitable for this operation.)
- Once repeater is held in the chosen position, carefully insert the fixing bolts through the mounting lugs of the Repeater and into the sleeve/anchor sections of the fixing in the wall and tighten the bolts.
- IMPORTANT!** The repeater needs to be mounted tightly to eliminate vibration.

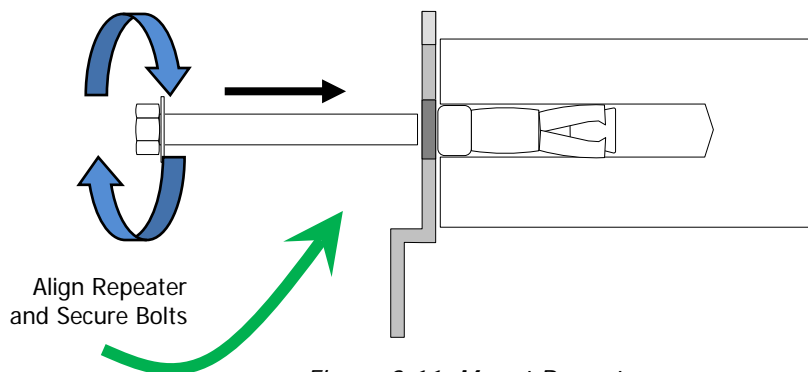



Figure 2-11. Mount Repeater

2.3.3.4 Recommended Additional Fixing



ATTENTION! It is the installer's responsibility to ensure the repeater is installed in a secure manner.

Suggested precautionary measure:

- A bracket is provided to securely mount the repeater on the wall; however, as an additional precautionary measure, it is recommended to further secure the repeater to the wall (in addition to the bracket).
- This can be done using any appropriate method.

The following figures provide examples of additional fixings. In the examples, support is provided in the form of a cable harness loop that is looped around the repeater handle and secured to the wall or part of the building support structure.

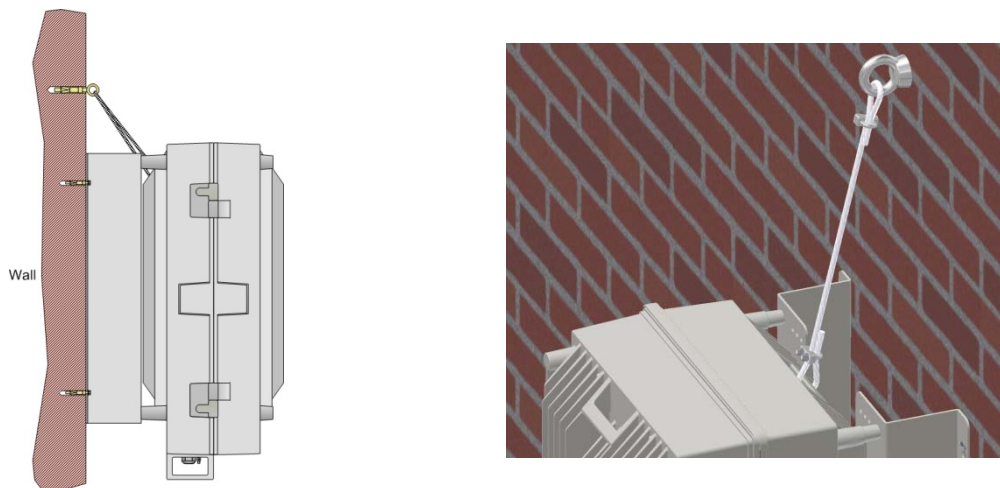



Figure 2-12. Example 1 – Additional Fixing to Wall

Another example is of a repeater installed on a stadium gantry. Again, the support can be in the form of a cable harness loop, using the handle of the repeater and part of the gantry structure.

 **ATTENTION!** Any other secure method can be used.

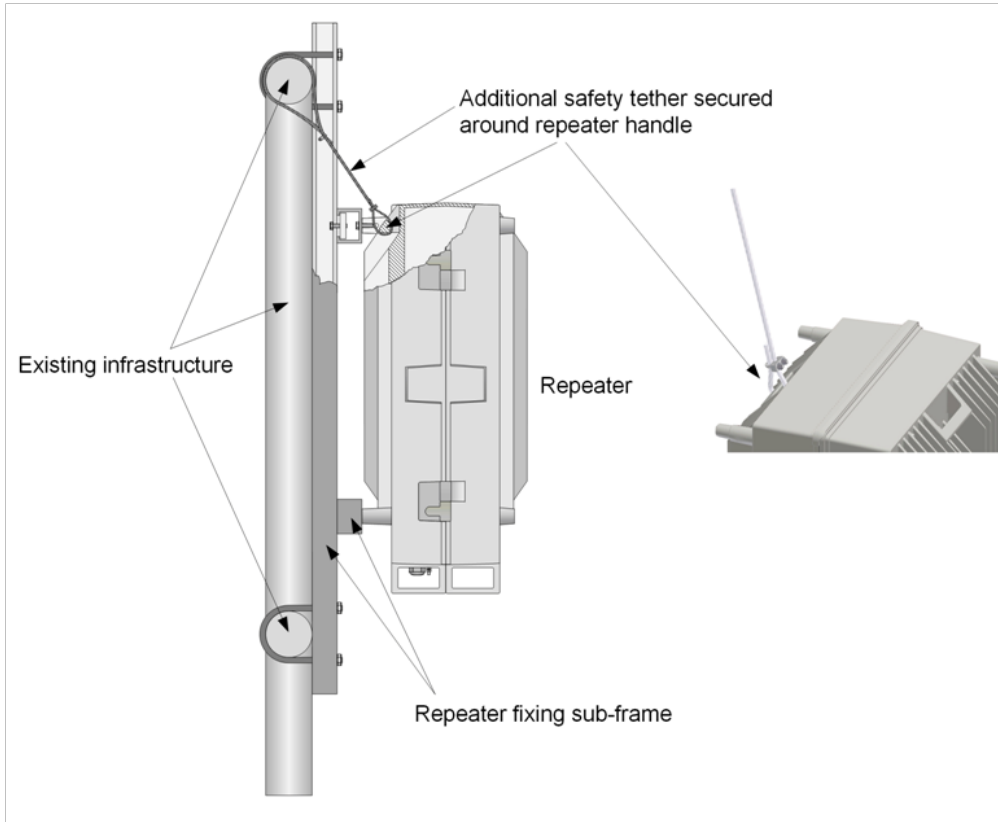



Figure 2-13. Example 2 – Additional Fixing to Gantry

2.3.4 Grounding



WARNING! Do not use the repeater grounding bolt to connect external devices.

To ground the repeater

- Refer to the grounding requirements described in Section 2.2.2.
- Connect the grounding protection to the repeaters ground lug.



Figure 2-14. Grounding the MBF-40

2.3.5 Fiber Optic Connection

This product is equipped with Class 1 Lasers, as per definition in EN 60825-1.

	<p>CAUTION!</p> <ul style="list-style-type: none"> ○ Un-terminated optical receptacles may emit laser radiation. ○ Do not stare into beam or view with optical instruments.
--	--

	<p>WARNINGS!</p> <ul style="list-style-type: none"> ○ Maximum input power should not exceed (zero) 0 dBm ○ Clean the Fibre connectors (receptacles and cables) before connecting. See APPENDIX B – F/O CLEANING PROCEDURE for details on F/O cleaning procedures.
--	--

To connect the optic fibre

1. Refer to the optic fibre requirements and connection guidelines described in section 2.2.4.
2. Open the repeater door.



Figure 2-15. Example of Open Repeater Model

3. Route the fibre through a corrugated sleeve (not supplied).



Figure 2-16. Run Optic Fibres through Sleeve

- Route the optic cable(s) via the optic hose fitter on the front panel.

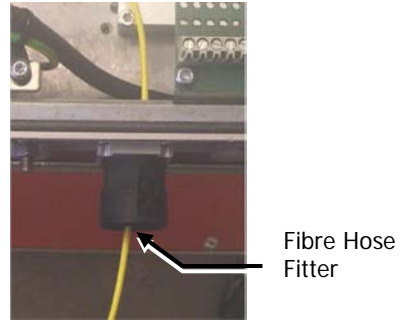

Figure 2-17. Route Optic Fibre via the Fibre Input

- Connect the Fibre(s) to the Fibre Optic Converter inside the repeater.

Make sure the Fibre is not bent too sharply inside the repeater as to avoid communication disruptions.

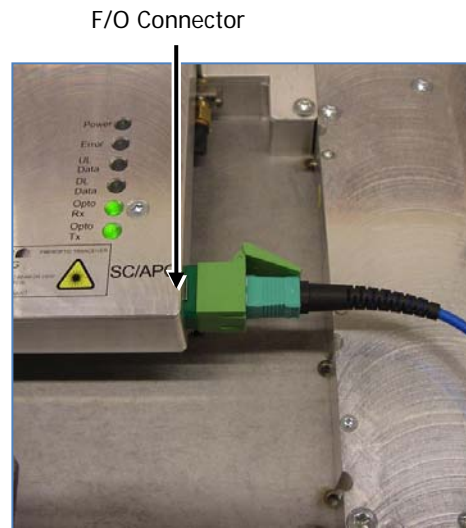

Figure 2-18. F/O Connection

- Place the fibre in the rubber seal.

NOTE: The sleeve (not supplied), together with the rubber seal, meets the protection standard IP65/NEMA4.



Figure 2-19. Run Fibre in the Rubber Seal

7. Adjust the fibre length inside the repeater and insert the seal into the "OPTO" inlet.



Figure 2-20. Adjust F/O Length

8. Attach the sleeve to the Fibre optic inlet.
This completes the procedure.

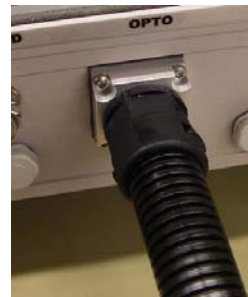



Figure 2-21. Connect Sleeve

2.3.6 Service Antenna Connections



WARNINGS! Be sure the antennas are connected before applying power to the repeater.

Connect the Server antenna to the Repeater DIN 7/16" server antenna connection.

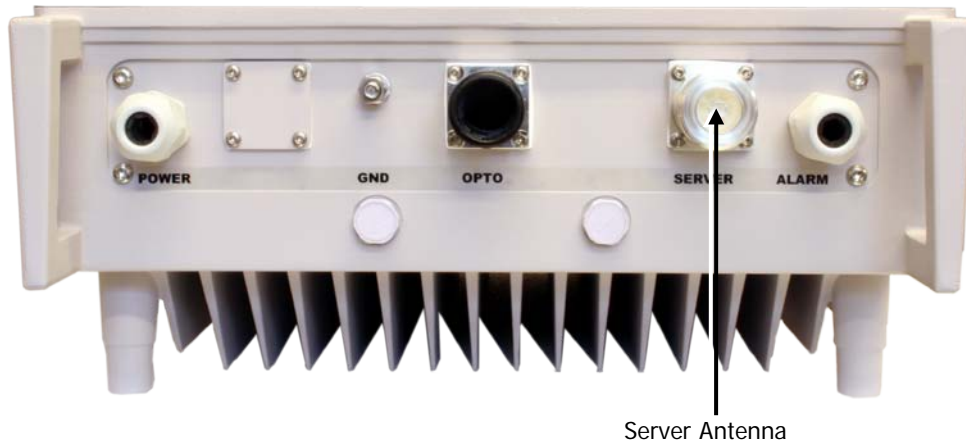



Figure 2-22. Service Antenna Connection

2.3.7 Power Connections and Power On

This section describes how to connect the power source to the repeater and power on the repeater. This section also provides information about the backup battery pack.

2.3.7.1 Power Connections



CAUTION!

- Make sure the antenna cables or 50 ohm terminations are connected to the repeater's antenna connectors before the repeater is turned on.
- Be sure a circuit breaker meeting the instructions given in Section 2.2.3.1 is connected near the unit at an easily reachable and accessible location from the unit.
- Be sure the power source to the repeater is disconnected before connecting the power wires to the repeater power plinth.
- Please be aware that the equipment may, during certain conditions become very warm and can cause minor injuries if handled without any protection, such as gloves.

For -48 VDC models - the -48VDC version of the power supply is designed to turn off if the supply voltage falls below -36V ($\pm 1V$), not to drain the feeding battery. It will turn on again as the supply voltage reaches -43V ($\pm 1V$).

To connect the power cables

1. Refer to the power requirements as described in Section 2.2.3.

2. Open the repeater door.
3. According to the repeater model, route the power cable through the power interface and towards the power plinth.

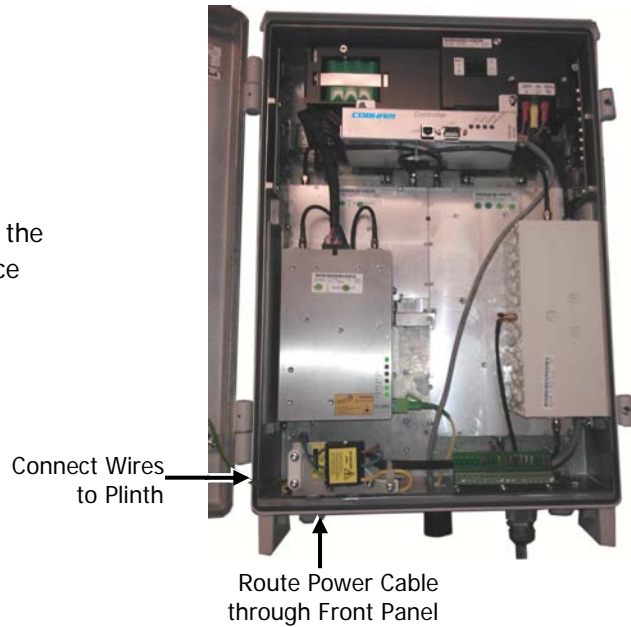

Figure 2-23. Example of MBF-40 Model

4. -48 VDC, connect wires to the plinth as follows:
 - Phase linked to brown cable
 - Neutral linked to the blue
 - Ground to the yellow/green.

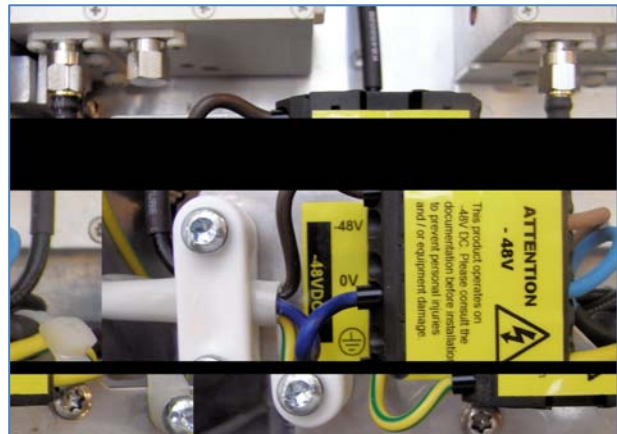

Figure 2-24. -48 VDC Power Connections

5. 115 VAC connect wires to the plinth as follows:
 - Phase linked to black cable
 - Neutral linked to the white cable
 - Ground to the green cable



Figure 2-25. 115VAC Power Connections

2.3.7.2 Power ON

The power supply has a switch which allows it to be set in two positions:

- ON – repeater is operational
- STAND-BY - the repeater is still connected to the power supply but not operational.

CAUTION! Make sure the antenna cables or 50 ohm terminations are connected to the repeater's antenna connectors before the repeater is turned on.

To power on the repeater

1. Locate the power supply switches inside the repeater.



Figure 2-26. Example of Single Power Supply Model

2. Switch on the power switch.
3. Switch on the BATT power.

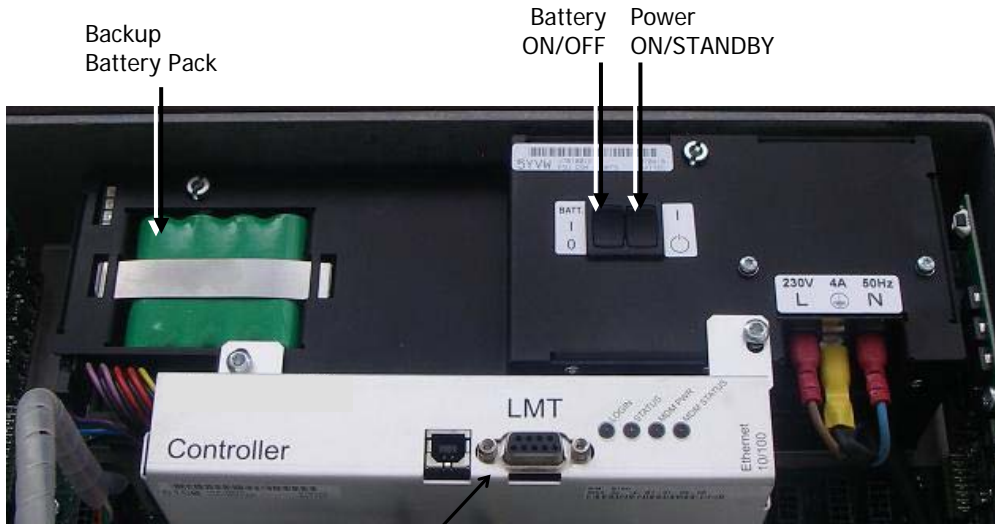

Figure 2-27. Power and Battery Switches

4. Referring to Section 5.3, verify the LEDs from the following modules are indicating correct operation:
 - Control module
 - F/O converter(s)
 - Power supply module(s)

2.3.7.3 About the Backup Battery

- On the Power Supply unit a rechargeable battery pack is mounted. This part also includes charging and supervision electronics.
- The backup battery will provide the Control Module with enough capacity to send an alarm in case of input power failure.
- The battery can be switched on and off. The switch is placed adjacent to the main power switch on the power supply.
- At delivery the back-up battery is connected.
- The battery is replaced by lifting the battery pack out of the crate and disconnecting the cable.

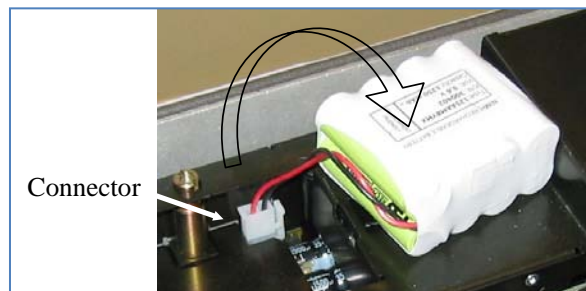

Figure 2-28. Backup Battery

2.3.8 Optional - External Alarm and Relay Connections

The connector plinth for the external alarms is located inside the repeater.

To connect external alarms or relay

1. Refer to section 2.2.6 for the external alarms and relay considerations.
2. Locate the alarms plinth inside the repeater.



Figure 2-29. Example of Repeater Showing the Location of the Alarms Plinth

3. Connect the alarm cords to the plinth according to the pin layout below (in the standard version Pins 14–18 are not used).

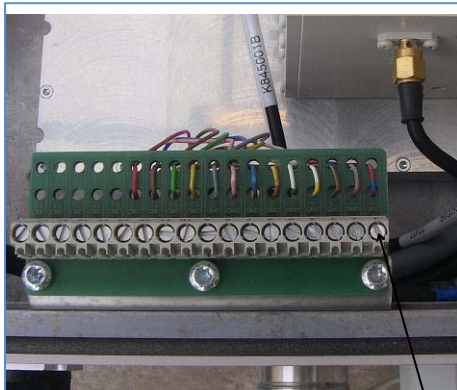

Pin #	Signal
1	External alarm 1A
2	External alarm 1B
3	External alarm 2A
4	External alarm 2B
5	External alarm 3A
6	External alarm 3B
7	External alarm 4A
8	External alarm 4B
9	Alarm +15V
10	Alarm 0V
11	Relay Output 1A
12	Relay Output 1B
13	GND
14	NC
15	NC
16	NC
17	NC
18	NC

Figure 2-30. External Alarm and Relay Pinout

Note the following

- Four external alarm sources can be connected to the repeater:
 - It is required to configure the external alarm polarity (part of the setup procedure — Section 4.3.3).

- The repeater can supply +15 VDC to an external alarm source through Pins 9 and 10. The maximum allowed load is 100 mA.
- Relay (Pins 11 and 12) can be connected to an external device to indicate an alarm. The Relay Can be configured to trigger on any number of internal and external alarms. The maximum current that can be supplied is 100 mA.

2.3.9 Closing and Securing the Repeater

The repeaters are secured with two hex screws (M8) and can also be locked with a key.

NOTE: The two screws must be fully tightened. Failure to do so may affect the IP65 compliancy and therefore any warranty.

3 GETTING STARTED

This chapter includes the following information:

- Opening a repeater session
- Navigating the WEB GUI
- Initial setup procedure

3.1 Opening a Repeater Session

Two types of session can be opened to the repeater:

- Direct session – this is usually a direct local session to the repeater
- Remote session – this is usually done by opening a session to the OMU II and then connecting to the repeater (via the OMU II)

3.1.1 Opening a Direct Local Session

NOTE: This connection requires downloading the USB driver from the provided setup disk (or connection to the internet, where the driver is automatically loaded).

To open a local session:

1. Open the MBF-40 cover
 - Connect to the USB port on the controller module. If the USB driver is not already installed on your laptop, the system will search for the driver on the provided setup disk or on the internet (if a network connection is available).
 - Run a browser and login according to the following section.

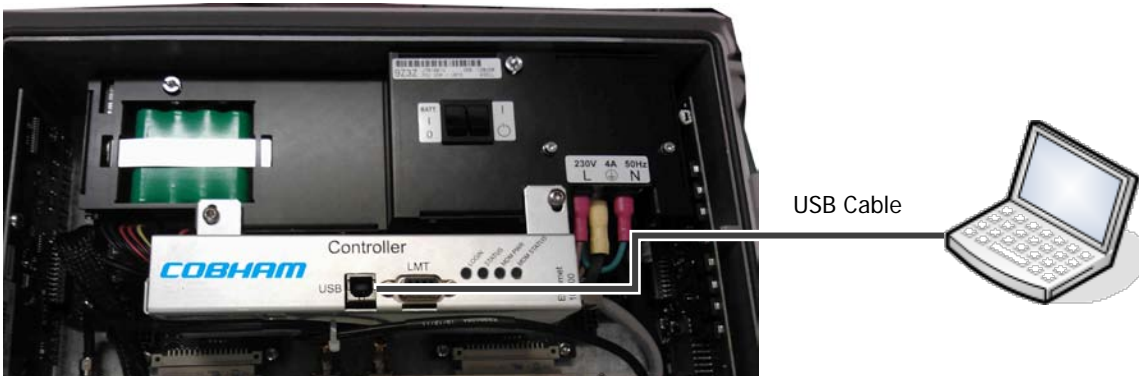

Figure 3-1. MBF-40 Controller Module Connection

2. Open the web browser and enter following IP address in address bar: 192.168.152.1.

The login dialog appears.



Figure 3-2. Login Screen

3. Use the following username and password to login:

- Username: **axell**
- Password: **AxellPasswd**

Note: It is highly recommended to change the default password according to section 4.5.3.

The web GUI Main Window appears. This is the same window is also viewed via the OMU II.

3.1.2 Opening an Indirect Session (via the OMU II)

1. Open a local or remote session to the host OMU II:
 - Remote session – open a Browser session in the same subnet as the host OMU II and enter the IP of the host OMU II (see OMU user manual for detailed procedure). Enter the OMU II User Name (e.g., **axell**) and Password (provided by your system administrator).
 - Local session– connect to the OMU II control module's USB or Ethernet ports. Enter the OMU II User Name (e.g., **axell**) and Password (provided by your system administrator).
 - After accessing an OMU II session, commission the MBF-40 according to the following section.



Figure 3-3. Connection to OMU II

3.2 Navigating the Web Interface

MBF-40 is managed via web GUI, where the web GUI options differ according to the type of session.

This section describes the following web GUI options:

- Home screen — always available when a session is opened to the repeater.
- Menu buttons — available only when a direct session is opened to the repeater; when an OMU II session is opened to the repeater, the menu button options are not available.

3.2.1 The Home Screen

The Home screen described below is always displayed when a session is opened to the repeater; however, the menu options are only available with a direct session (not via OMU II).

The Home screen with the menu options is shown below. The various areas are briefly described in the following page.

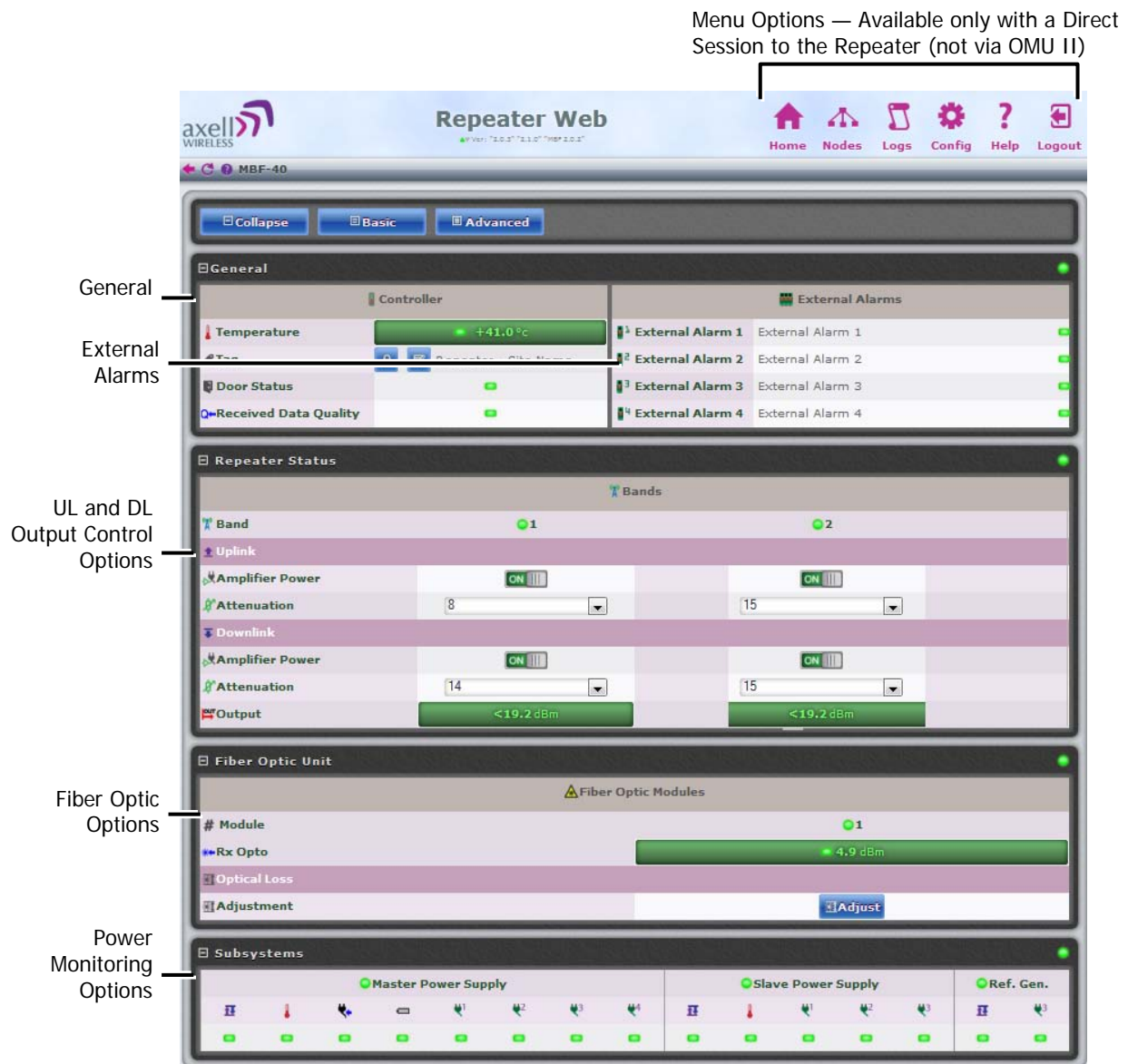

Figure 3-4. MBF-40 Home Screen





The screen is divided into four basic areas:

- Controller – shows general information on the MBF-40 device such as identification and temperature level.
- External Alarms – shows status of external alarms and the defined names.
- Repeater Status – RF connection status is divided into two sections:
 - Band – shows general band status.
 - Uplink/Downlink – gain, attenuation and connection status in the specific direction.
- Fiber Optic Unit – shows status on connection to remote OMU and allows for optical link adjustment.
- Sub-systems – overall status of all sub-systems such as power supplies, battery, communication etc.

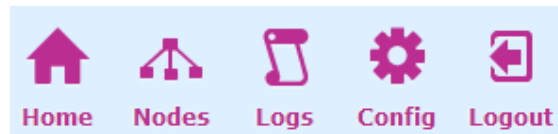
3.2.2 Menu Options Buttons

The menu options described below are only available via a direct session to the repeater.



Tab	Description
 Home	Provides a general status and alarm information. Switching to <i>Advanced View</i> will toggle a more detailed view of each band and module.
 Nodes	Lists the remote nodes – corresponding OMU and units connected the specific OMU.
 Logs	List of recent operations. Section 5.2.
 Config	Provides a range of MBF-40 configuration procedures such as communication, RF, Date and Time, Password, etc. Section 4.3.
 Logout	Logout of the system.

3.3 Commissioning the Repeater

After the repeater is connected to the OMU II, it is automatically identified by the OMU II via the Fiber connection and the unit can then be commissioned from the OMU II. The commissioning process consists of a few simple steps.

MBF-40 Setup and Commissioning consists of the following

1. Opening an OMU II session – for accessing the MBF-40 configuration window (via OMU II)
2. Recommended — configuring the MBF-40 Tag (site identification).
3. Performing optical loss adjustment on the connected MBF-40
4. Setting the required RF attenuation and gain levels on the remote MBF-40
5. Assigning the unit a recognizable name (according to its location)

3.3.1 Defining Site Information – MBF-40 Identification

It is recommended to assign each MBF-40 a recognizable name that will identify the location, site name, etc.

To set MBF-40 TAG

1. In the **Home** window, click the edit button next to **Tag**.

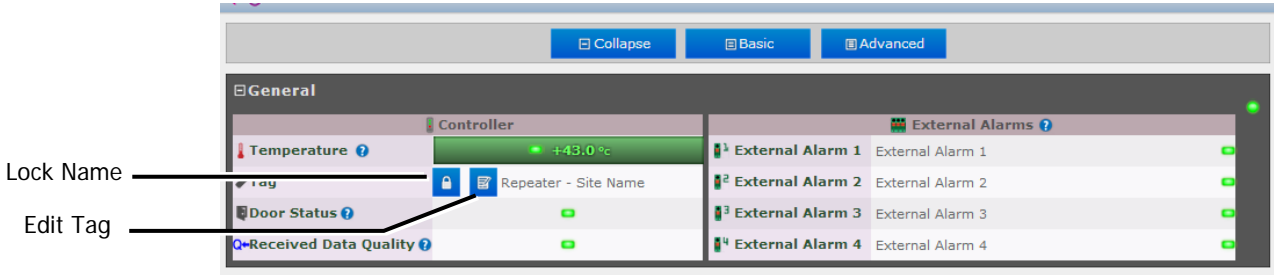

Figure 3-5. Set MBF-40 TAG Name

2. Enter the Name (up to 30 characters), click OK and click **Apply**.

3.3.2 MBF-40 Optical Loss Adjustment (OLA)

MBF-40 OLA is performed from the OMU II. For MBF-40 remotes, the maximum compensation is increased to 26dB to support shorter Fiber optic distances.

NOTE: It is assumed that you have opened and OMU II session.

To perform MBF-40 OLA (via OMU II)

1. From the **OMU II main window**, click the **Opto Adjust** button.

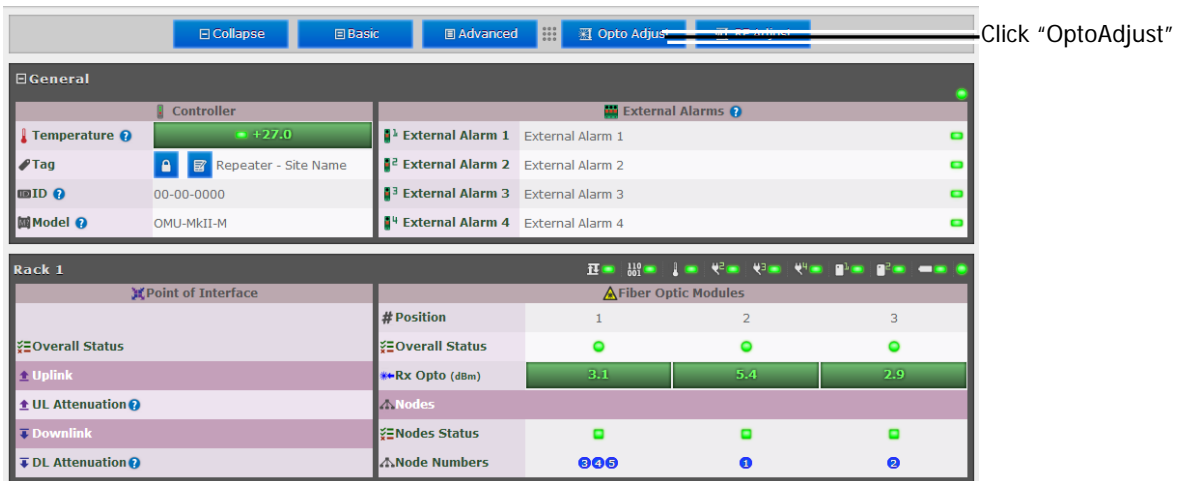

Figure 3-6. OMU II Main window

The OLA screen appears.

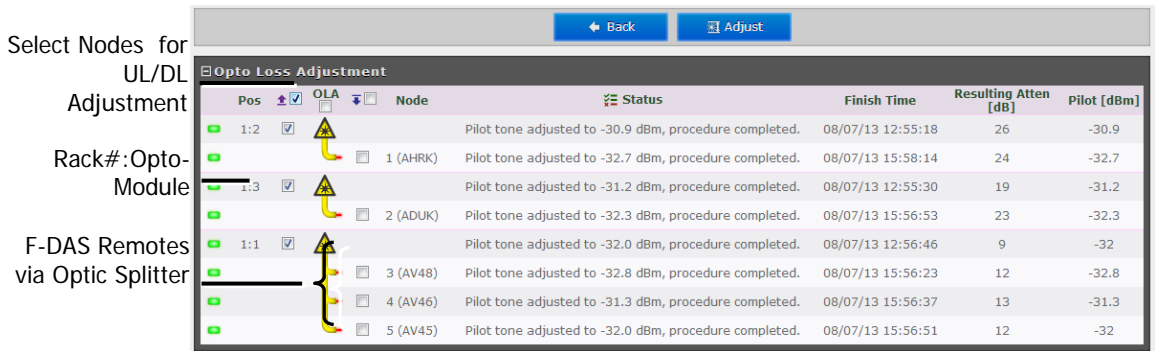

Figure 3-7. Configure and Initiate Optical Loss Adjustment

The screen lists the OLA options (and status) for each link. The links are listed according to the OMU II slot to which the remote is connected.

A brief description of the OMU II OLA screen is given below.

Column	Description
Pos	Each rack corresponds to an OMU unit whereas each Slot corresponds to an opto-module. Slots are numbered according to their position in the OMU chassis (numbered left to right).
Select All	Batch selection options: <input checked="" type="checkbox"/> - mark all remotes for UL opto-adjustment. <input checked="" type="checkbox"/> - mark all remotes for DL opto-adjustment. <input checked="" type="checkbox"/> OLA - mark all remotes for DL and UL adjustment.
Node	Node list number and identification (e.g. AHRK)
Status	Displays an Error if process failed. If successful the pilot tone used and the adjustment level will be displayed.
Resulting Attenuation	Compensation level used for the opto-module (in dB).

3. Mark the checkboxes corresponding to the MBF UL/DL node to be adjusted.

NOTE: The process may take several minutes depending on the size of the system and remote distance.

3.3.3 RF Balancing

The MBF-40 RF Balancing procedure can be performed manually (the automatic option specified in section 3.3.3.2 will be available in the future) via the OMU II web interface.

3.3.3.1 Manual RF Balancing

NOTE: If connected locally, enter the MBF-40 Home screen and skip to step 2.

The manual balancing procedure consists of the following steps:

- Verifying the DL RF output level is maximized by setting the required DL attenuation of the signal.
- Setting the UL attenuation according to the DL.
- In case of noise, adjusting the UL attenuation to reduce noise

To balance the MBF-40 UL and DL outputs

1. Access the MBF-40 Configuration window:
 - Click on the **Nodes** button. The below pane appears
 - Click **Control** next to the node to be balanced.

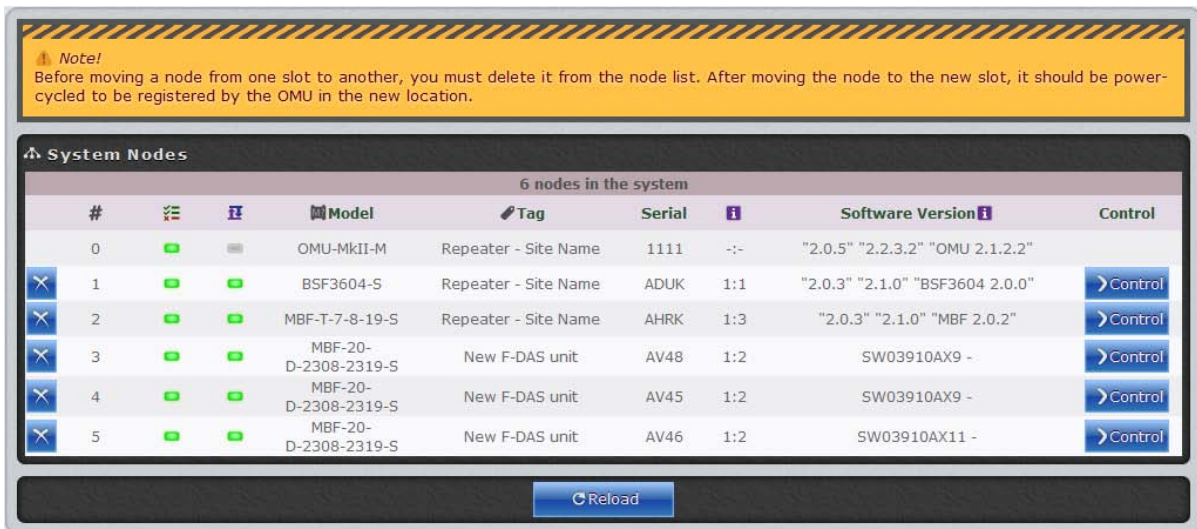

Figure 3-8. OMU Node Screen

The repeater Home window appears.

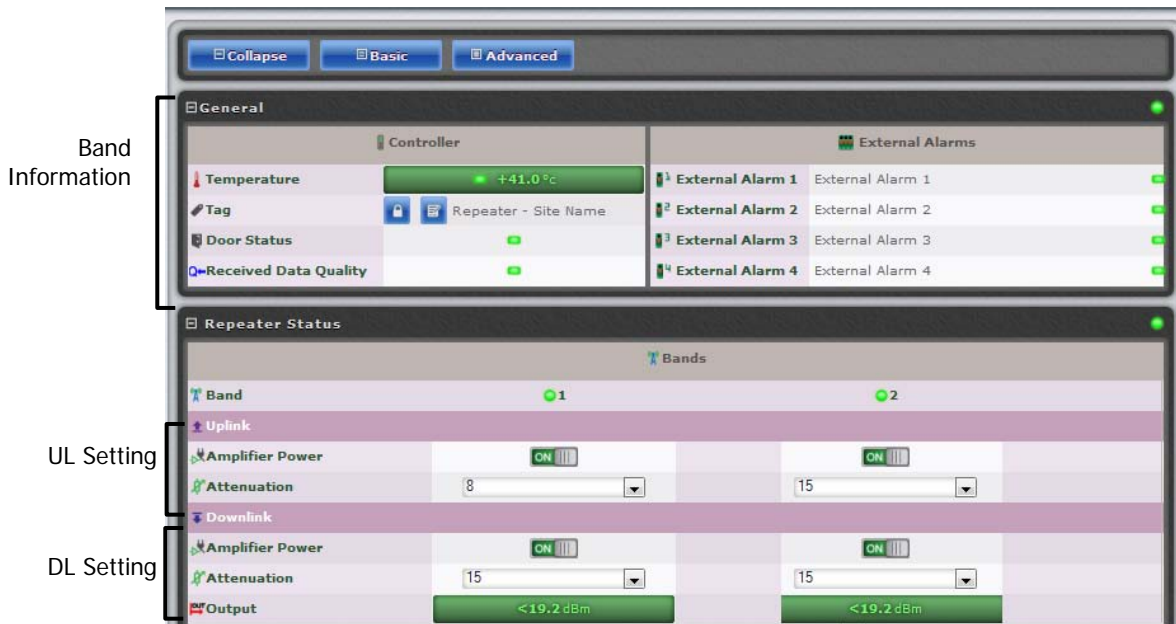

Figure 3-9. Partial view of the MBF-40 Configuration window

2. In the Downlink:
 - Verify the **Amplifier** for each band is ON.
 - Set **Attenuation** to maximum value (15 dB).
 - Lower the **Attenuation** level step by step until the desired Output power level is reached (Zero attenuation = maximum gain).
 - Verify the amplifier saturation is green.
3. In the Uplink:
 - Verify the **Amplifier** for each band is ON.
 - Set **Attenuation** equal to the value set in the DL (above).
 - Verify the amplifier saturation is green.

NOTE: If noise is detected on the link, reduce only the uplink for optimal signal.

3.3.3.2 Automatic MBF-40 RF Balancing

NOTE: This feature will be available in future release.

To access the Automatic RF Adjustment pane

1. Access the OMU II **Home** window and click on **RF Adjustment**.

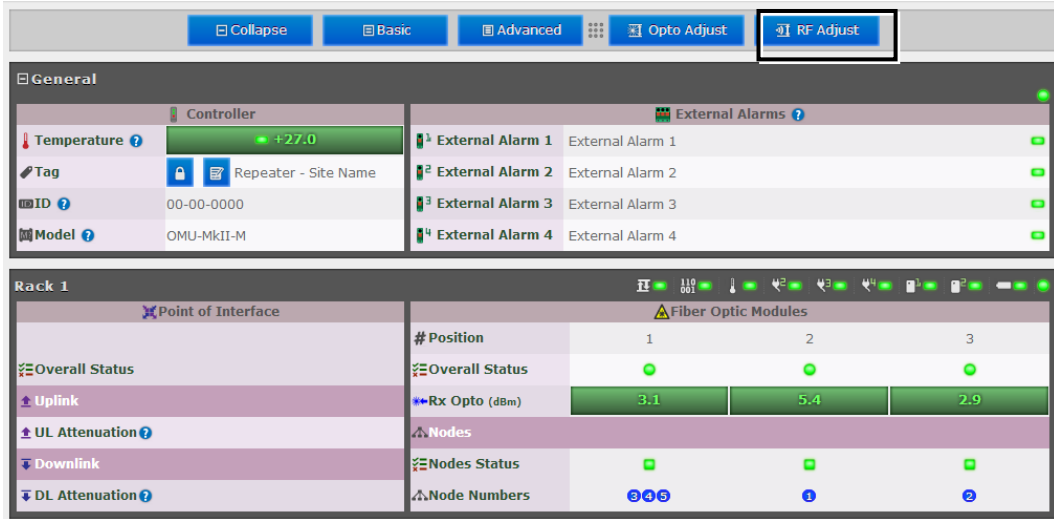

Figure 3-10. OMU II Main window

2. The following pane appears.

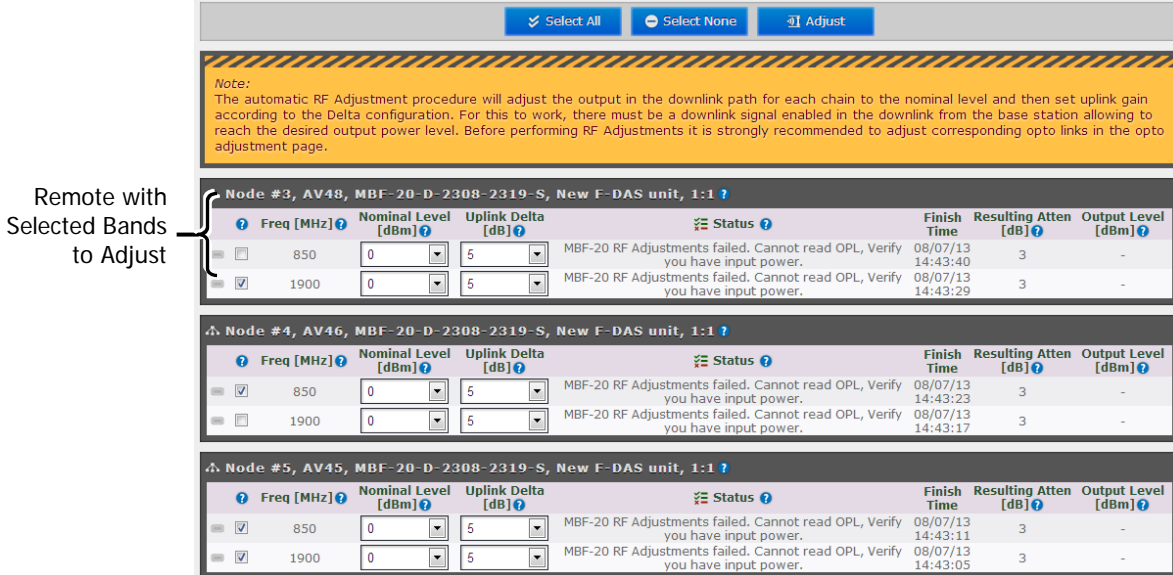

Figure 3-11. Adjust Window

3. Select the bands of each remote to be adjusted (e.g., 1900 MHz band on Node #3)
4. Adjust the following for each band:
 - Nominal level (dBm)
 - Uplink delta (dB)
5. Click **Adjust**. The procedure may take several minutes depending on the number of units selected.

3.3.4 Integration into the AEM

NOTE: Integration into the AEM is only performed from the AEM side – no action is required from the MBF-40 side.

The AEM automatically connects to the repeater and downloads all the repeater information. The AEM then configures the repeater with the IP address where alarms and reports should be sent to, and optionally with a secondary IP address where the repeater can connect to in case connection to primary IP fails.

When heartbeat reports and alarms are sent from the repeater to the AEM also the latest information about the status and RF-configuration is included. This means that the AEM operator always has information about the current status in the AEM database (and does not need to call the repeater to find this out).

NOTE: Once the repeater is integrated to the AEM, all changes to the repeater should preferably be done from the Element Manager in order to ensure that the database always contains correct information.

3.3.5 What Next?

The MBF-40 unit is now ready for operation. You may monitor the unit's general status via the OMU II Main window and if the node is faulty (red LED), access the dedicated configuration screen in Basic or Advanced view for more information.

NOTE: Consult the OMU II user manual for additional information on RF and optical adjustments.

4 DIRECT ACCESS MENU OPTIONS

This chapter describes the menu options available ONLY when opening a direct session to the MBF-40.

4.1 Overview

The available menu options can be used to configure remote management options and for detailed fault sourcing and troubleshooting.

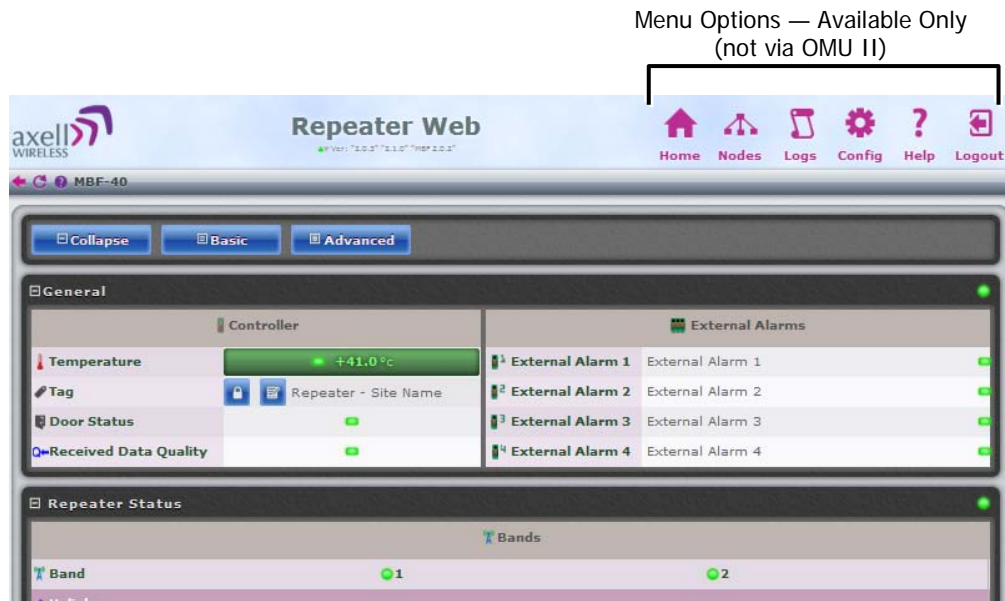

Figure 4-1. MBF-40 Partial Home Screen with Menu Options

Two of the buttons are of special interest:



Provides a range of MBF-40 configuration procedures such as communication, RF, Date and Time, Password, etc. Section 4.3.*



List of recent operations. Section 5.2.*

4.2 Configuration Screen Overview

The configuration screen provides access to a range of configuration and management options.

To access the configuration screen

Click on the  menu option. The following screen appears.



Figure 4-2. Config Menu Options

Option	Description
Site Information	Configure and display MBF-40 identification information. See Section 4.3.1.
External Alarms	Used to activate and assign names to external alarms. See Section 4.3.3.
Change password	Used to update system login password for the logged-in user. See Section 4.5.3.
Date and Time	Used to configure the time stamp for dating MBF-40 events. See Section 4.3.2.
Ethernet	Used to define the IP Address for remote access via Ethernet. See section 0.
Remote Communication	Used to configure remote communication parameters and AEM integration. See section 4.4.
Axell Shell	Command line used to communicate with the remote units. List of commands is found under Help. See Section 4.7.
Attribute Reference	CLI commands and attributes directory. See Section 4.8.
Reboot controller	Soft restarts the MBF-40 device. See Section 4.6.
SNMP Agent	SNMP Agent configuration. See Section 4.4.2.

4.3 General Parameters

This section describes the following options:

- Viewing site information and repeater information (repeater ID, SW and HW versions, etc.)
- Date and time
- Configuring external alarms
- Setting Ethernet IP address

4.3.1 Viewing MBF-40 Site Identification and General Information

The Site Information button provides access to MBF-40 hardware and software version information.

To view MBF-40 Site Information



Click the **Config** menu button and click on the **Site Information** icon. Two areas are displayed:

- Control Module – provides hardware and software version information.
- Site Information – provides MBF-40 identification information.



Figure 4-3. MBF-40 Site Information

4.3.2 Date & Time

The repeater date and time are automatically set from the OMU II. However, the option for direct settings is available as well.

To set the Date & Time:

1. Click the **Config** button.

2. Click on  icon.

3. Do one of the following:
 - Either, enter the correct date and time according to the displayed formats.
 - Or, click on **Local Time** to set the time according to the PC running the Web-GUI.

4. Click **Apply**.

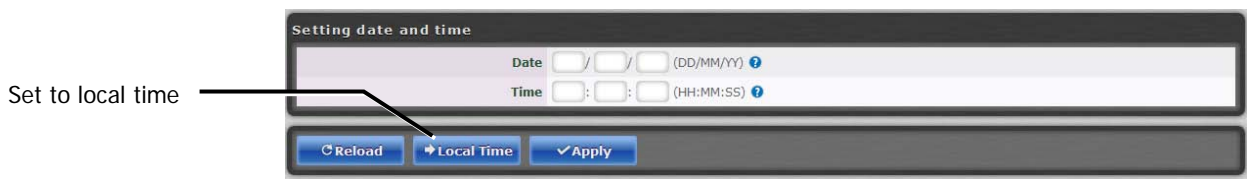

Figure 4-4. Configure Date and Time

4.3.3 Configure External Alarms

It is required to configure any connected external alarms according to the trigger (high or low) and it is recommended to assign the alarms recognizable names (such as Door Open, High Temperature, etc.)

To configure the external alarms

1. In the Main menu, click the **Config** button.

2. Click on the  icon.

3. For each alarm:
 - Set the Trigger as High or Low as required.
 - Assign the alarm a recognizable description

4. Click **Apply**.

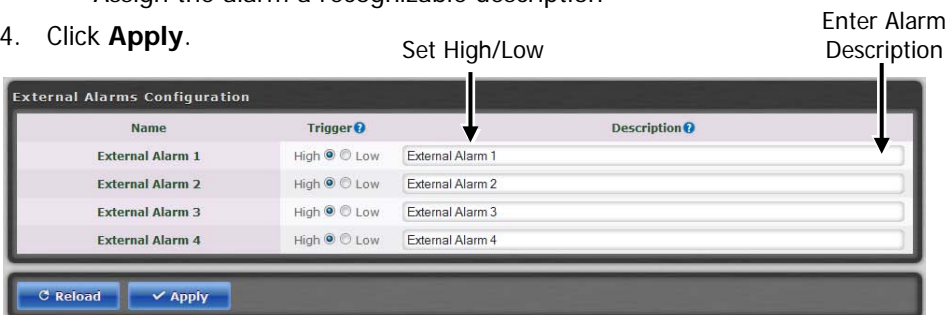



Figure 4-5. Configure External Alarms

4.3.4 IP Address

This procedure describes how to set up the IP address either manually or configure for acquisition via DHCP (usually configured for local management options).

To configure the IP address

1. In the Main menu, click the **Config** button.
2. Click on  icon.
3. For manual IP address configuration:
 - Select Manually Configure IP Address.
 - Set the IP, subnet mask, default gateway and DNS addresses.
 - Click "Apply".
4. For DHCP IP address configuration:
 - Select "Automatically Obtain IP Address" (DHCP).
 - No other settings are required.
 - Click "Apply".

The Manual configuration settings are illustrated below.

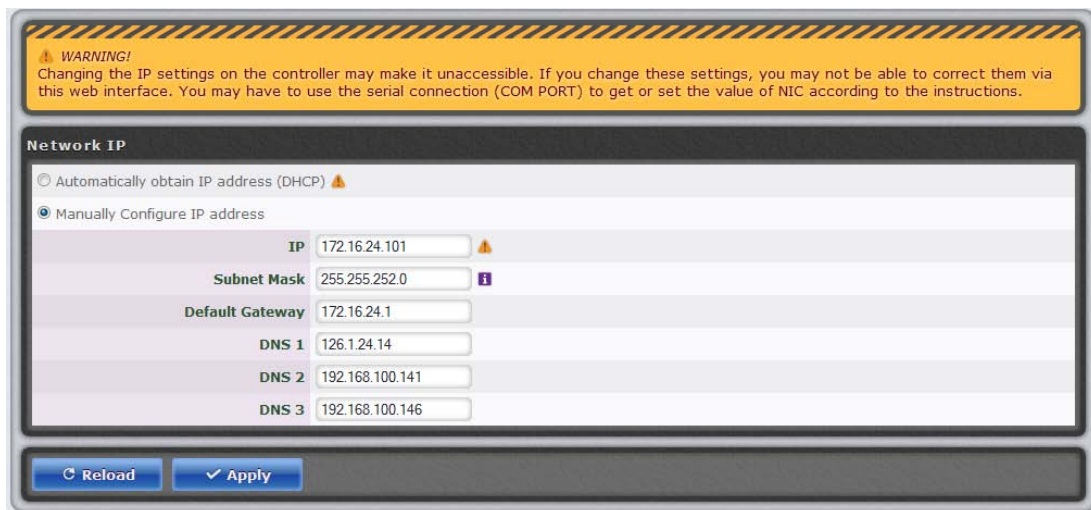



Figure 4-6. Configure Local Network Parameters

4.4 Remote Communication Setup

This section describes the Ethernet and SNMP setup.

4.4.1 TCP/IP and Ethernet

1. Click on the **Config** menu button.
2. From **Device: Method** select  (Ethernet: TCP/IP).
3. Click **Apply**.

The screenshot displays the configuration interface for Remote Communication. It is divided into two main sections: 'Remote Communication' and 'TCP'.
 In the 'Remote Communication' section:
 - 'All Remote Communications' is set to 'ON' with a status indicator.
 - 'Device:Method' is a dropdown menu currently showing 'ETH:TCP'.
 - 'Communication Device' is set to 'Ethernet Connection'.
 - 'Communication Method' is set to 'TCP/IP connection'.
 In the 'TCP' section:
 - 'AEM Main IP Address' is set to '-'.
 - 'AEM Main Port' is set to '1024'.
 - 'AEM Secondary IP Address' is an empty text input field.
 - 'AEM Secondary Port' is set to '1025'.
 At the bottom of the interface, there are two buttons: 'Reload' and 'Apply'.

Figure 4-7. Remote ETH Configuration

4.4.2 SNMP Support

The MBF-40 includes SNMP support, including an SNMP Agent and SNMP traps (alarms). All SNMP queries and traps are supported either via the OMU II or a direct connection to the unit.

4.4.2.1 SNMP Traps Parameters

The MBF-40 sends SNMP traps to user defined destination addresses.

NOTE: One destination address can currently be defined via the Web. Seven more destination addresses can be defined via the Shell application.

To configure the SNMP traps destination address

1. Click on the Configure button (top right corner).
2. Select "Remote Communication".
3. In the Device: Method field, select "ETH:SNMP".

The screenshot displays two configuration panels. The top panel, titled "Remote Communication", has a toggle switch for "All Remote Communications" set to "ON". Below this, a dropdown menu for "Device:Method" is set to "ETH:SNMP". The "Communication Device" is set to "Ethernet Connection" and the "Communication Method" is set to "Simple Network Management Protocol". The bottom panel, titled "SNMP", contains three input fields: "SNMP Trap Address" with the value "126.1.24.18", "SNMP Trap Port" with the value "162", and "SNMP Trap Community" with the value "public". At the bottom of the interface are "Reload" and "Apply" buttons.

Figure 4-8. Remoter Communication and SNMP Display Areas

4. Define the SNMP trap destination IP address (additional addresses can be defined via the Axell shell.).
5. Enter the (destination address device) Trap Port and its Community parameters.
6. Click "Apply".

4.4.2.2 SNMP Agent - Activating and Configuring

The SNMP agent provides inventory management for hosted repeaters (on which the SNMP agent is enabled) and a table of active alarms in the controller or Fiber system for remote querying.

The SNMP Agent is responsible for responding to queries and carries out requests. The SNMP Agent also provides the proprietary Axell MIB (AXELL-AM-MIB), accessible via any SNMP manager (e.g., HP OpenView).

All SNMP queries to the remote are implemented via an OMU session.

To allow SNMP agent queries

- To allow SNMP queries of the OMU II – the SNMP agent must be enabled on the OMU II.
- To allow SNMP queries of the remote devices via OMU II – the SNMP agent must be enabled on the OMU II and on the remote devices.
- Remote units configured with an IP address and connected to the communication infrastructure, can be queried directly.

To activate the MBF-40 SNMP Agent

1. Click on the Config button (top right corner) and select SNMP Agent Config. The following pane appears:

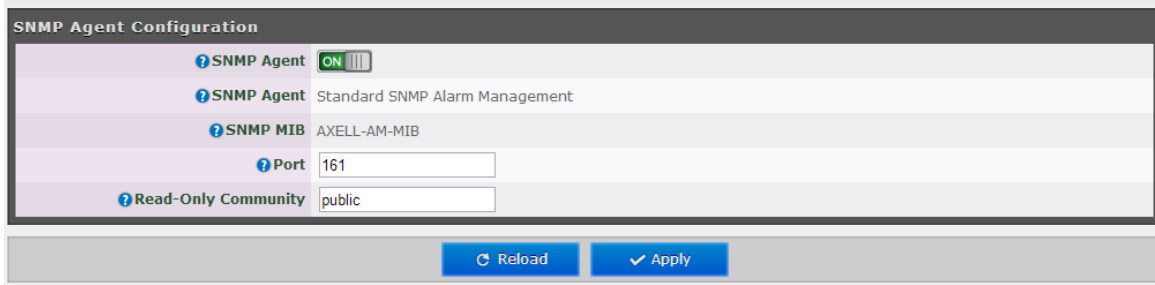

Figure 4-9. SNMP Agent Configuration Display Area

2. Set the **SNMP Agent** toggle to **ON**.
3. Set the **port** and the **Read-Only community**.
4. Click **Apply**.

4.5 User Accounts

The MBF-40 comes pre-configured with default usernames and passwords in the various administration levels.

At the moment, updating user accounts is available only via command line interface (CLI) or Axell Shell. See the Common Commands and Attributes v2.4.0 document for detailed commands and syntax or click on the Help button at the top right of the Web-GUI screen.

4.5.1 Default User Accounts

User Name	Default Password	Details
Axell	AxellPasswd	Default user name.
omcunname	iwnkhoob	Element Manager (AEM) user account. This account will not generate VLI, LGO or CLR alarms.
sysadmin	AxellAdmin4050	This is the system administration password which is used for firmware upgrades and user administration. Escalation to this level is achieved by issuing command SYSADMIN from the user prompt.
useradmin	UseradminPwd23	This account contains user administration privileges. Escalation to this level is achieved by issuing command USERADMIN from the user prompt.

NOTE: It is strongly recommended to change the default user names and passwords immediately at commissioning. This is done by using the command **ACT PASSWORD**. Please refer to the User Administration section in Common Commands and Attributes document for detailed syntax.

4.5.2 User Access Levels

In this generation of the system, standard users can be promoted to login via the web Interface, inheriting the read-write or read-only access to this interface.

There are five different access levels:

Access Level	Default User Levels
Read-Only	axell, omcuname, useradmin, sysadmin
Read-Write	axell, omcuname, useradmin, sysadmin
Web	axell
User Administrator	omcuname, useradmin, sysadmin
System Administrator	omcuname, sysadmin

Note: New users added to the system have read-only access.

Users may be promoted to read-write and/or web access using the **ACT USERPROMOTE** command. See **Common Commands and Attributes** document for details on promoting users.

Note: Users omcuname, sysadmin and useradmin cannot be promoted to Web Access due to security reasons.

4.5.3 Change Password

To prevent unauthorized access, it is highly recommended to change the default password of the user.

NOTE: Note that you can only change the password for the User Name with which the session was accessed.

To change the Password

1. In the Main menu, click the Config button.

2. Click the  icon.

3. For the current user name (e.g., axell):

- Enter the new password.
- Repeat the entry.

4. Click "Apply".

NOTE: The password is not encrypted during transmission. If the connection to the repeater is not safe, do not use this screen. Use the CLI commands using an encrypted connection, if possible (i.e. SSH).



The image shows a 'Change Password' dialog box with a title bar. It contains three input fields: 'User Name' with the value 'axell', 'New Password' (empty), and 'Repeat Password' (empty). A small yellow warning triangle is visible to the right of the 'New Password' field. At the bottom of the dialog is a blue button with a checkmark and the text 'Apply'.

Figure 4-10. Change Password Dialog

4.6 Reboot



CAUTION! USE THE REBOOT FUNCTION ONLY IN CASE OF EMERGENCY!

To reboot the Control Module:

1. Click the Config tab.
2. Click on the  icon.
3. Approve the Reboot sequence.



Figure 4-11. Reboot Option Dialog

4.7 Axell Shell (Command Line Interface)

To access the Axell Shell:

1. Click on the **Config** button.
2. Select the  option.

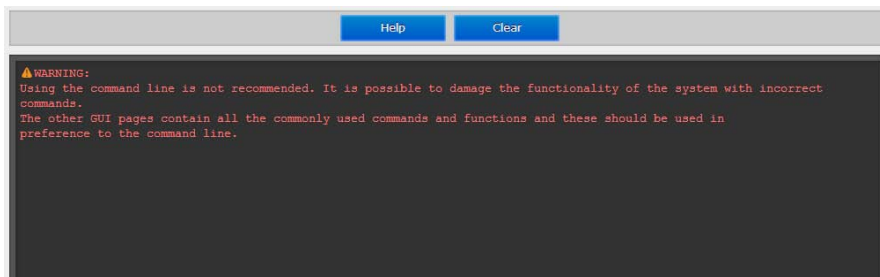

Figure 4-12. Axell Shell Window

The **Axell Shell** button invokes the CLI pane. It is used to run some of the commands that are currently not provided by the Web GUI (user privileges and administration) and/or for advanced troubleshooting and configurations procedures.

All configuration and management procedures can be implemented using this interface. Please refer to the *Attribute Reference* section (by clicking the Config button on the top right and selecting Attribute Reference – see Section 4.8) for detailed syntax and available commands. You may also consider viewing the “MBF-40 Commands and Attributes” document.

4.8 Attribute Reference

To access the Attribute Reference

1. Click on the Config button.
2. Select the "Attribute Reference" option.

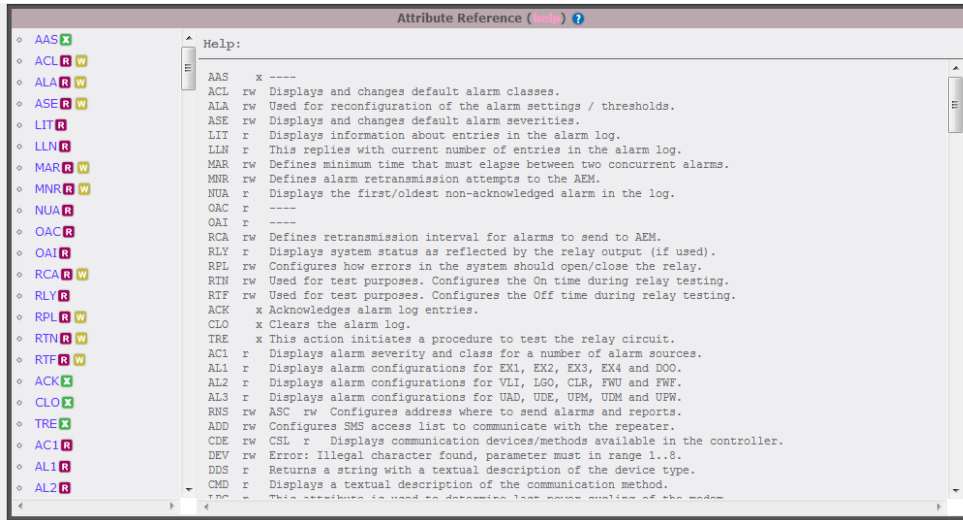

Figure 4-13. Attribute Reference Display

The Attribute Reference lists all available CLI commands and includes details and examples on how to use the commands. Additional information may be found in the *MBF-40 Commands and Attributes* document.

5 MONITORING AND FAULT SOURCING

MBF-40 provides the following monitoring and fault sourcing options:

- Web GUI Home screen Advanced mode — shows general status of system and components
- Web GUI Logs screen — provides logs of faults and operations
- Module LEDs — can be seen locally when opening the Repeater

This chapter describes these fault sourcing tools.

Note the following

- The input/output RF level power level monitoring windows are for indication only and should not be considered a replacement for laboratory test equipment accuracy of measurement of actual signal levels. The error of measurement will be high at low input levels.
- The normal operating range of signal measurement is as follows:
 - Downlink Output range +20 dBm to +43 dBm
 - Uplink Output range -10 dBm to +5d Bm

5.1 Monitoring Via the MBF-40 Home Screen

In addition to RF settings and readings, the MBF-40 Home screen provides detailed information on the operation status of internal modules. This information can be used to aid in remotely troubleshooting the Remote.

To access the MBF-40 Main Monitoring and Configuration window

1. Access the OMU II main windows, click the Nodes button, choose the remote related node and click the adjacent **Control** button. The MBF-40 Home window appears in Basic View. To view more details, click **Advanced**.



Figure 5-1. MBF-40 Main Screen Advanced

5.1.1 General Page Area

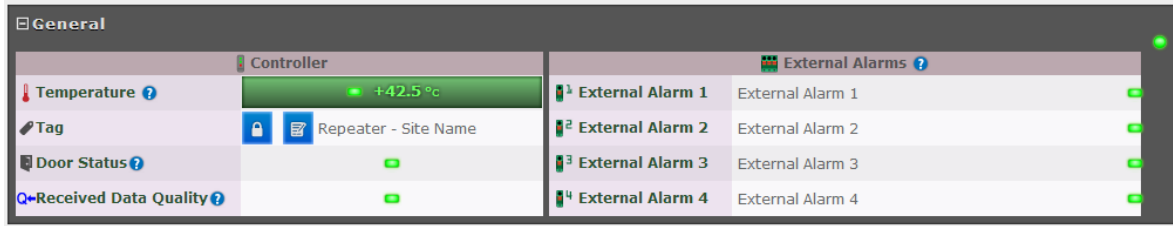

Figure 5-2. MBF-40 General

Indicator	Description
Temperature	Current ambient temperature
Tag	Name of Repeater, user customizable
Door Status	Green if closed
Received Data Quality	Check data for consistencies

5.1.2 Detailed view of the MBF-40



Figure 5-3. MBF-40 Repeater Status

Indicator	Description
Band	Overall band status.
Radio System Identifier	Band(s) and technologies in use
Comm	DL/UL status
Power	Power indication
Radio Board Firmware	Firmware related error
Radio Board Temp	Radio board temperature indicator
Amplifier Power	Turn amp. on/off.
Attenuation	Use to define DL/UL RF attenuation level per band
Amplifier	Amplifier status
Saturation	Saturation level status
Power Level	Power supply status
Input/Output	Input/output power levels
Comm	Communication status
Temperature	Temperature level and status indicator
Condition	Signal conditioning status
Fatal Condition	Critical condition indicator (RED = fault)

5.1.3 Detailed view of Fiber Optic Unit

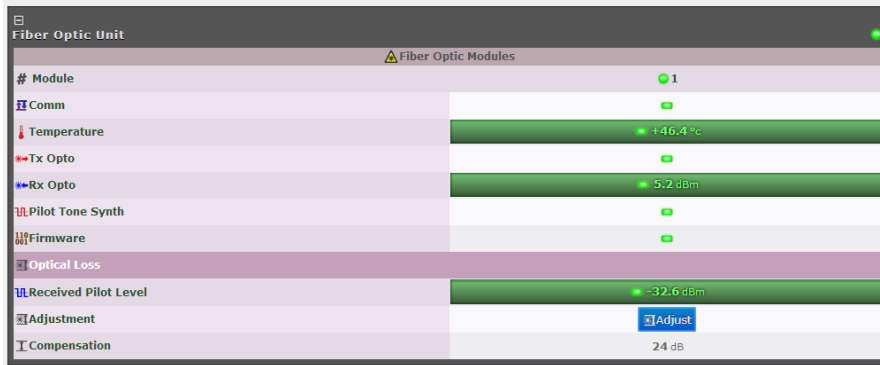

Figure 5-4. MBF-40 F/O Status

Indicator	Description
#Module	Overall optic module status
Comm	Optic connection status
Temperature	Temperature level and status indicator
Tx Opto	DL optic signal status
Rx Opto	UL optic signal strength and status
Pilot Tone Synth	Pilot tone synthesizer status
Firmware	Firmware related error
Received Pilot Level	Pilot tone level received in optic module
Adjustment	Perform UL OLA (on repeater side)
Compensation	Compensation performed on the optic link

5.1.4 Subsystems

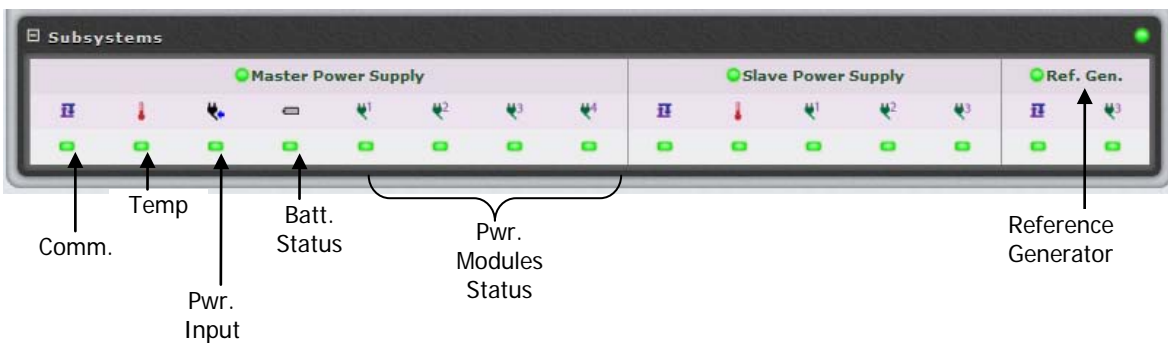

Figure 5-5. Subsystems Alarms Display

5.2 Logs Screen

The Alarms Log displays the last 100 alarms and/or user actions on the remote system in a chronological order. By hovering with the mouse over each alarm, full alarm details are available, including alarm descriptions, severities, alarm classes and time of event.



Figure 5-6. Logs

To receive a summary containing all information on a reported incident in the Log list, simply hover with the mouse over the specified Log and view all details contained in the Log (see below).



Figure 5-7. Logs —Summary

Column	Description
Date & Time	Time of occurrence
Source	ID of reporting source
Description	Additional alarm information (e.g. Open Door)

Icon	Description
	Alarm attended to and cleared.
	System alarm – displayed when system functionality may be compromised.
	Alarm status: OK
	Alarm status: Error
	Acknowledge alarm – Green = Acknowledged.
	Click to change acknowledgement. Use the Ack All button to acknowledge all alarm logs.

5.3 Module LEDs

This section describes the LEDs of the internal modules. The modules are accessed if the remote is opened. An example of the MBF-40 model is shown in Figure 5-8.

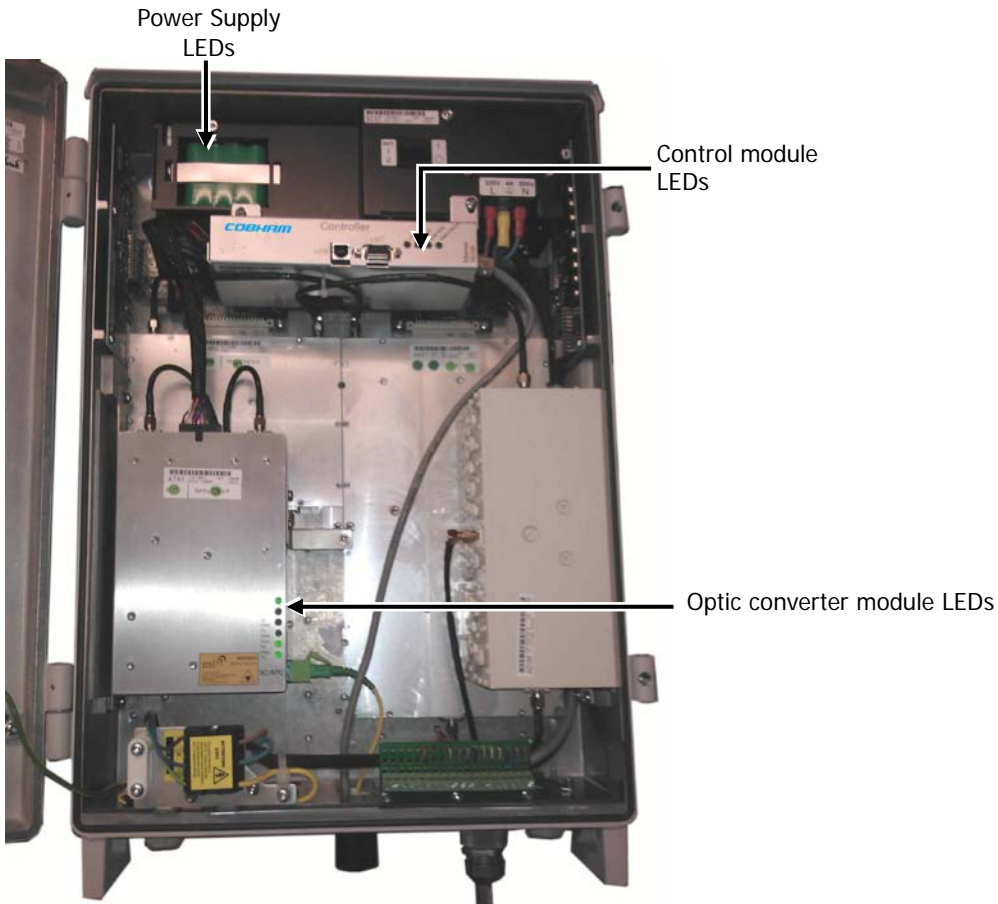
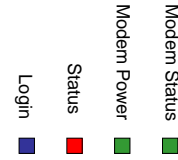

Figure 5-8. Internal View (Door Open)

5.3.1 Control Module LEDs

The Control Module has four LEDs which give information regarding the status of the MBF-40.

The two LEDs "Modem Power" and "Modem Status" do not fill any function and can be disregarded.



Blue LED - Login		
	Quick flash	Control Module switched on, someone logged in locally and/or remotely
	Off (except for a quick flash every 10th second)	Control Module switched on, no one logged in
	Off (permanent)	Control Module switched OFF
Red LED - Status		
	Quick flash	Control Module switched on, one or more errors/alarms detected
	Off (except for a quick flash every 10th second)	Control Module switched on, status OK
	Off (permanent)	Control Module switched off

5.3.2 F/O Converter LEDs

There are 6 LEDs on the module to indicate the status.



LED 1, Power, Green	
On	Unit is powered on
Off	Unit has no power
LED 2, Error, Red	
On	Error detected
Off	No error
LED 3, UL Data, Yellow	
On	Communication is ongoing in the uplink direction
Off	No communication
LED 4, DL Data, Yellow	
On	Communication is ongoing in the downlink direction
Off	No communication
LED 5, Opto Rx, Green	
On	Received RF signal on Fiber channel is above threshold
Off	Input level below threshold
LED 6, Opto Tx, Green	
On	Transmitted RF signal on Fiber channel is above threshold
Off	Output level below threshold

5.3.3 Power Supply LEDs

This section provides a detailed description of the LEDs and fault examples.

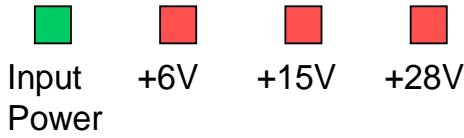

LED 1, Input Power, Green	
Slow flash	Power supply unit operating on AC or DC
OFF	Power supply unit not operating
LED 2, +6V, Red	
Slow flash (every 10 seconds)	+6V power supply operating
Quick flash	+6V power supply not operating or operating with malfunction
LED 3, +15V, Red	
Slow flash (every 10 seconds)	+15V power supply operating
Quick flash	+15V power supply not operating or operating with malfunction
LED 4, +28V, Red	
Slow flash (every 10 seconds)	+28V power supply operating
Quick flash	+28V power supply not operating or operating with malfunction

Examples	
<p>Input Power +6V +15V +28V</p>	<p>LED 1 is flashing slowly, LED 2 – 4 are flashing slowly (once every 10 seconds) => power supply unit is operating without problem</p>
<p>Input Power +6V +15V +28V</p>	<p>LED 1 is flashing slowly, one or two of the red LEDs are flashing quickly => Input power is operating but there is a problem with some of the other voltages</p>
<p>Input Power +6V +15V +28V</p>	<p>LED 1 is flashing slowly, all of the red LEDs are flashing quickly => Input power is out and unit is operating on backup battery</p>

6 MAINTENANCE

6.1 Cautions and General Statements

- The system normally operates without any operator intervention or maintenance. If in the unlikely event of any unit failure, the faulty repeater should be replaced. A failed unit can be removed and replaced with a spare while the rest of the system (other repeaters) is still operating. However, the power supply of the failed repeater should be isolated from the power before anything is replaced.
- In the event of a malfunction in the system, the status of the antenna systems as well as the continuity of the cabling should be checked before replacing any modules within the repeater.
- The input / output RF level power level monitoring windows are for indication only and should not be considered a replacement for laboratory test equipment accuracy of measurement of actual signal levels. The error of measurement will be high at low input levels.
- The normal operating range of signal measurement is as follows:
 - Downlink Output range +20 dBm to +43 dBm
 - Uplink Output range -10 dBm to +5 dBm
- In the event of a failure Cobham Wireless's support service should be contacted for advice on a possible module replacement or other action to be taken.
- If a shipment of a repeater back to Cobham Wireless is made within the period of guarantee the original packing must be used.
- Component Replacement - None of the modules in the repeater can be replaced without removing the repeater from its mounting and opening the cover of the repeater.
- Product Disposal - Disposal of this product must be handled according to all national laws and regulations. For detailed information regarding materials, please refer to Cobham Wireless.



CAUTION! Please be aware that the equipment may, during certain conditions become very warm and can cause minor injuries if handled without any protection, such as gloves.

6.2 Batteries

The Repeater contains two types of batteries:

- A battery pack in the power supply unit, consisting of 8X NiMh batteries.
- A button cell CR1216 on the controller board.



CAUTION!

- Please be aware that the equipment may, during certain conditions become very warm and can cause minor injuries if handled without any protection, such as gloves.
- Risk of explosion if battery is replaced by an incorrect type. Dispose of used batteries according to local laws and instructions.







APPENDIX A – SPECIFICATIONS

Frequency Range	Uplink (UL)	Downlink (DL)	Operational BW UL/DL	Composite Output Power (*)
SMR900	896-902MHz	929-941MHz	6MHz/12MHz	+37 dBm
General Parameters				
Noise Figure	3 dB Typical (maximum gain)			
Ripple	<2dB			
Propagation Delay	< 2µs			
Gain UL/DL	Nominal 66dB, adjustable, in 1dB steps			
System Impedance	50Ω			
Return loss at antenna connections	>16dB			
Antenna Connectors	DIN 7/16, female duplex			
Optical Parameters				
Wavelength DL/UL	1310/1550nm			
Optical output power (UL)	0dBm			
Max optical Loss	10dBo			
F/O Connector	SC/APC			
Power Specifications				
Power Supply	230VAC, 115VAC or -48VDC			
Power consumption	140W for single band			
Mechanical				
Dimensions	21.3" x 15" x 7.8" 540 x 382 x 198mm			
Weight	Single band: 44.0lbs (20kg)			
Enclosure	NEMA 4 (IP 65)			
Environmental				
EMC	FCC			
Operating Temperature	-13 to +131°F (-25 to +55°C)			
Storage Temperature	-22 to +158°F (-30 to +70°C)			
Humidity	ETSI EN 300 019-2-4 (see compliance below)			
Complies With				
Radio	FCC in accordance with part 90, IC in accordance with RSS131			

APPENDIX B – F/O CLEANING PROCEDURE

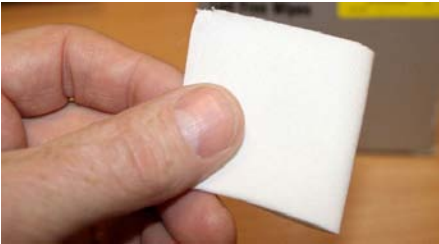
NOTE: The process is demonstrated on an OMU F/O module and is similar to all F/O equipment supplied by Cobham Wireless.

Tools

Tool Description	Illustration
<p>Fiberscope connected to a PC running the appropriate viewing software. It is highly recommended that some form of Fiber viewing equipment such as a Fiberscope is used to ensure that all Fiber connections are clean before termination; failure to do so could result in poor system performance</p>	
<p>Lint-free swabs (box), Cobham Wireless P/N 99-000127</p>	
<p>Lint-free wipes (pack) Cobham Wireless P/N 99-000125</p>	
<p>Fujikura "One Click" cleaner Cobham Wireless P/N 98-900004.</p>	
<p>99% isopropyl alcohol (can), Cobham Wireless P/N 99-000126</p>	
<p>Cletop type S Cassette Cleaner, Cobham Wireless P/N 98-900001</p>	

Dry F/O Cleaning Procedure:



WARNING! Invisible laser radiation might be emitted from disconnected Fibers or connectors. Do not stare into beams or view directly with optical instruments.

1. Before cleaning the optical connectors on the OMU it is advisable to clean the connector of the mating cable being attached to the optical port.

An unclean optical connector is often the cause for reduced system performance. A bit of dust or oil from a finger can easily interfere with, or block light. Fortunately, it is very easy to clean the connector. Be sure to use the correct procedure for the given connector. When disconnected, cap the SC/APC connector to keep it clean and prevent scratching the tip of the ferrule.

Use a product specially designed for the purpose, such as the Cletop type S Cassette Cleaner.

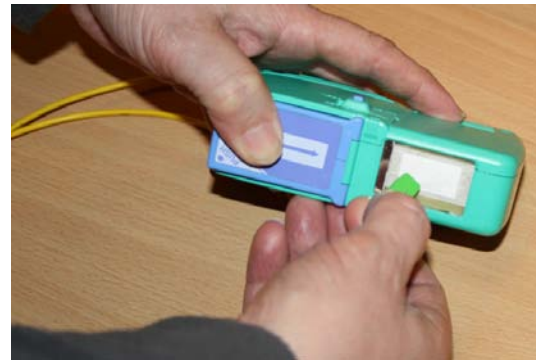

2. Begin by dry cleaning the F/O bulkhead connector (shown below is the Fujikura One-Click in use).



IMPORTANT!

Always make sure there is a way of inspecting the connector after cleaning. Cleaning can actually leave the end-face in a worse condition, since alcohol residue is one of the most difficult contaminants to remove.

3. Remove the protective cap from the cleaning-head end of the "One Click" cleaner, lift the protective end-cap on the Fiber connector and offer-up the end to the Fiber connector



4. With the cleaning-head end fully engaged in the connector, push until an audible “click” is heard
5. Without fully withdrawing the cleaning head end push it in again twice more, each time until an audible “click” is heard.
6. Withdraw the “One Click” cleaner and replace the protective end cap.

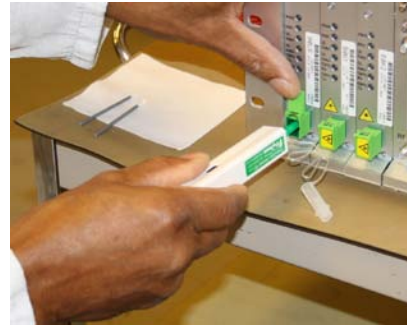

7. Inspect the Fiber connector using a Fiberscope. On the PC monitor, verify that there is no contamination present on the connector end-face.
8. If the connector is dirty, clean it with a wet cleaning technique followed immediately by dry cleaning. This is to remove any remaining residue from the wet clean (the following steps demonstrate a wet cleaning technique).

Wet F/O Cleaning Procedure

ATTENTION!

Invisible laser radiation might be emitted from disconnected fibers or connectors. Do not stare into beams or view directly with optical instruments.

1. Lightly moisten a new lint-free wipe with 99% isopropyl alcohol (Step 1 below).

Tip: Have a dry lint-free swab available for immediately drying after performing the wet-cleaning.

2. Lightly press and turn a clean lint-free swab in the moistened area of the wipe to moisten the swab. It is important that the swab is not too wet (Step 2 below).
3. Insert the moistened lint-free swab into the bulkhead adapter. Lightly press and rotate several times in the same direction (Step 3 below).

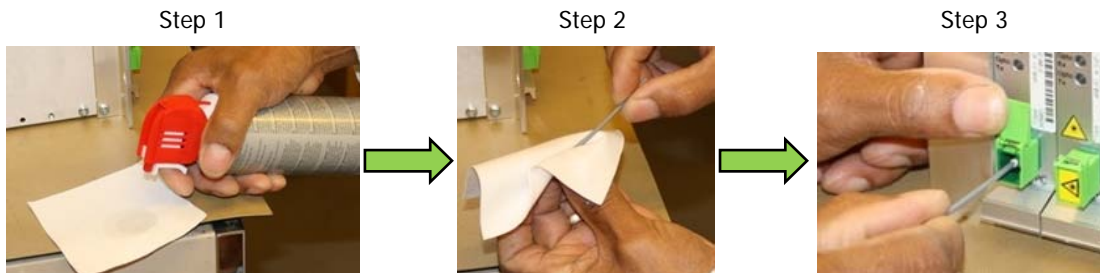

Figure 6-1. Wet-Cleaning Technique

4. Immediately use a dry lint-free swab to clear any remaining alcohol residue.

NOTE: Do not re-use any of the wipes and/or swabs. Dispose of them properly.

5. Follow steps 3 to 6 of dry cleaning above
6. Re-inspect the Fiber using the Fiberscope. On the computer monitor, verify that there is no contamination present on the connector end-face.
7. If the fibre is still dirty, go back to step 1 (wet cleaning) and repeat the entire process.

NOTE: The entire wet/dry cleaning cycle should only be used twice, if the fiber is still dirty after two cycles of wet/dry cleaning seek advice from the Cobham Wireless Support Desk.