



TASER Axon Body 2 Camera User Manual



Model AX1001



IMPORTANT SAFETY INSTRUCTIONS

Read all warnings and instructions. Save these instructions.
The most up-to-date warnings and instructions are available
at www.TASER.com

MMU0057 Rev: X1

Contents

1	Chapter 1: Introduction
1	What Is the Axon Body 2 Camera System?
1	Important Safety and Health Information
1	Additional Reading
2	Chapter 2: Getting to Know Your Axon Body 2 Camera
4	Accessories
4	Parts
5	Assembly and Use
6	Chapter 3: Recording with the Axon Body 2 Camera
6	Operating Modes
6	BUFFERING Mode (Turning on the Camera)
7	EVENT Mode (Starting Recording)
7	Muting Audio Recording
7	Adding Markers to Recorded Video
8	Battery Status
8	Configuring Your Axon Camera
8	Adjusting the Audio Prompt Volume
8	Turning off the Camera LEDs (Stealth Mode)
9	Using AxonView
9	Pairing Your Axon Body 2 Camera with a Smart Device
10	Configuring Your Camera to Use a Local Access Point (a Wi-Fi Connection) on Your iOS Device
11	Other Settings
13	Chapter 4: Notification Reference Tables
13	Audio Prompts
13	LED Status
13	Operation LED
14	Function LED
14	Battery LED

14	Upload Status LED
15	Chapter 5: Axon Signal Operations
16	Chapter 6: Care and Maintenance
16	Cleaning the Axon Body 2 Camera
16	Charging the Battery
17	Replacing the Battery
18	Chapter 7: Troubleshooting
18	Customer Service
18	Warranty Policy
18	Warnings
18	Radio Waves
20	Declaration of Conformity 

Chapter 1: Introduction

What Is the Axon Body 2 Camera System?

The Axon Body 2 is a camera system incorporating an audio and video recording device. This camera is designed for use in tough environmental conditions encountered in law enforcement, corrections, military, and security activities. The Axon Body 2 camera is designed to record events for secure storage, retrieval, and analysis via Evidence.com services. The recorded events are transferred to your storage solution via the Axon Dock, or by using Evidence Sync software installed on a Windows computer.

The Axon Body 2 camera has two operating modes designed to accommodate the needs of law enforcement, corrections, security, and the military. The default mode, or BUFFERING mode, provides pre-event buffering to capture activities that occur prior to the user activating the EVENT mode. In addition, the Axon View application enables playback of footage on a smart device for review prior to storing the data.

Important Safety and Health Information

Read, understand, and follow all warnings and instructions before using this product. The most up-to-date warnings and instructions are available at www.taser.com.

Additional Reading

This manual explains how to operate the Axon Body 2 camera hardware. Other manuals cover additional aspects of the Axon Body 2 system. These documents are available at www.taser.com.

The Axon Academy website explains how to register for the Evidence.com website, configure settings, install Evidence Sync software, assign personnel to cameras, recharge your camera, and transfer video from an Axon device to a computer. Visit academy.axon.io/.

Detailed instructions for using Axon cameras and other TASER products with Evidence Sync are available in the *Evidence Sync User Manual*.

For instructions on using Axon cameras with a smart device, see the *Axon View for Android Devices User Manual* or the *Axon View for iOS Devices User Manual*.

If you have an Axon Dock, see the *Axon Dock Quick Start Guide* for how to transfer information and recharge your camera.

Chapter 2: Getting to Know Your Axon Body 2 Camera

The Axon Body 2 camera includes physical controls to enable video and audio capture while providing visual, audible, and vibration notifications of the Axon Body 2 camera's state of operation.

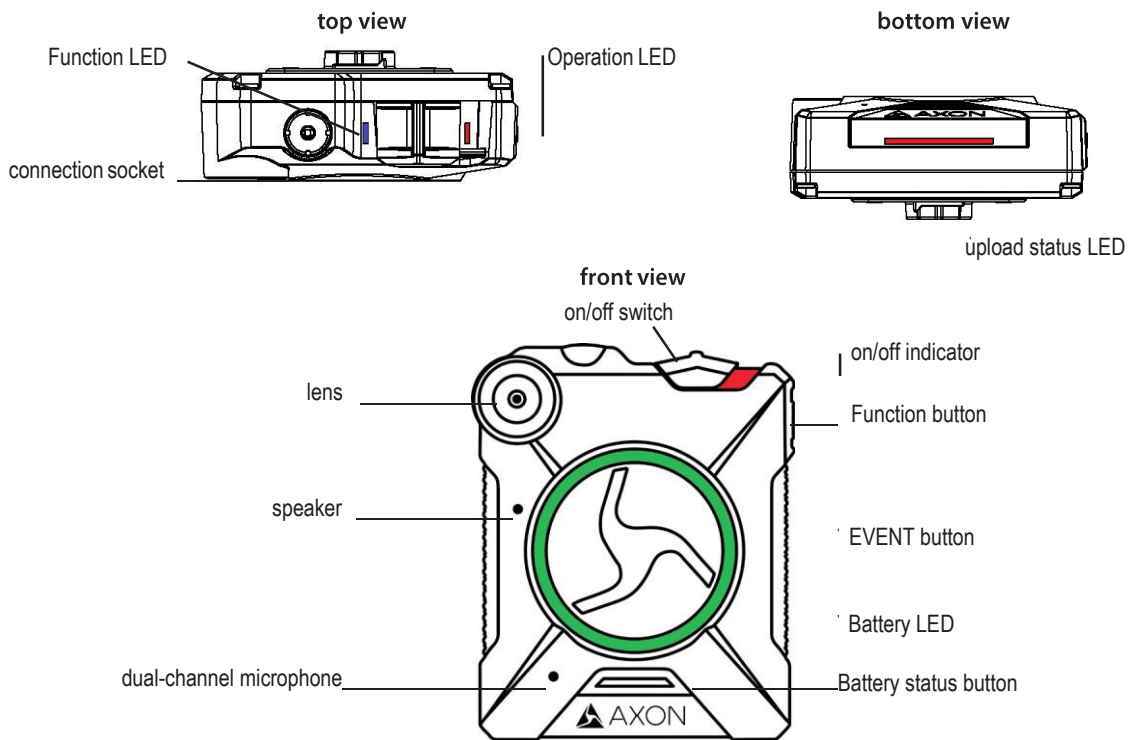

Operation LED

Shows the camera's current operating mode (for Battery status, see the battery LED, described below).

Operating Mode	Operation LED
Recording	Blinking Red
Recovering interrupted video*	
Buffering	Blinking Green
Booting up/powering down	Solid Red
Error state**	

* When the Function LED also is blinking red.

** When the Function LED also is solid red.

Function LED

Shows when certain functions are enabled.

Function Enabled	Function LED
Mute	Blinking blue
Camera error*	Solid red
Bluetooth feature is booting up	Solid blue
Wireless accessory configuration (WAC)	Blinking magenta

* Use the power switch to turn the camera off and on.

Connection Socket – Enables data transfer and recharging.

On/Off Switch – Turns the camera’s power on or off.

On/Off Indicator – When the camera’s power is turned on, the red portion is exposed. When the camera power is turned off, the red portion is covered from view.

Speaker – Provides audio notifications.

Function Button – Used in device pairing, to mute the device, and to add markers to the video as it is recorded.

EVENT Button – Used to start and stop recording. (Double-press to start; hold for 4 seconds to stop recording.)

The camera might take several additional seconds to close out of the video when it is powered off before stopping an event.

Battery Status Button – When pressed, the Battery button lights up the Battery LED, which momentarily indicates the remaining battery capacity only (with default settings, the battery LED does not indicate the operating mode).

Battery LED

When lit, momentarily indicates the remaining battery capacity (with default settings, it does not indicate the operating mode).

When you turn the camera on, the Operation LED turns solid red until the system is ready to use. Then the Operation LED blinks green (BUFFERING mode) and the Battery LED goes out. The camera can be configured to the Battery LED operates in sync with the Operation LED. In BUFFERING mode both the Operation and Battery LEDs will blink green, and in EVENT mode both will blink red.

Battery Status	Battery LED
Battery capacity is 41–100 percent	Green
Battery capacity is 20–40 percent	Yellow
Battery capacity is less than 20 percent	Red during operation; flashing red and yellow during charging
Battery is critically low	Blinking red and yellow
BUFFERING mode (if configured)	Blinking green
EVENT mode (if configured)	Blinking red

Dual-Channel Microphone – For audio recording.

Upload Status LED

Indicates status when the camera is uploading data to the Evidence.com website via the Axon Dock.

System Status	Upload Status LED
Initial connection (momentary)	Solid red (for 20 seconds or fewer)
In queue awaiting upload	Solid yellow

System Status	Upload Status LED
Device ready (all videos uploaded successfully) and fully charged	Solid green
Device not assigned, agency mismatch, camera set in the offline mode, or device error	Blinking red
Uploading data	Blinking yellow – DO NOT remove the camera from the Axon Dock
Firmware update, internal battery charging, extremely low battery, or memory full	Blinking red and yellow – DO NOT remove the camera from the Axon Dock
Transfer error, device re-trying to transfer	Blinking green and yellow
Network error (no connection)	Blinking red, yellow, and then green (cycling all colors)
Axon Dock has no communication with the camera. Contact TASER customer service.	LED off

Lens – The camera lens.

Pressing buttons causes the Axon Body 2 camera to emit audio alerts (beeps) to indicate system actions. See *Chapter 4: Notification Reference Tables* for more information.

Accessories

The Axon Body 2 camera is designed to work with the new Axon RapidLock mounting system. The RapidLock mounting system consists of the attachment piece (called the key) on the camera and the various mounting options including the attachment receiver (called the lock). To engage the Axon RapidLock, insert the key of the camera into the lock of the mount and turn it 90 degrees counterclockwise (when you are looking straight at the mount). To release the camera from the mount, turn the camera 90 degrees clockwise.

The various mounts that use this system can be used with a wide variety uniforms, and holds the camera to your shirt, patrol vest, jacket, or belt.

Parts

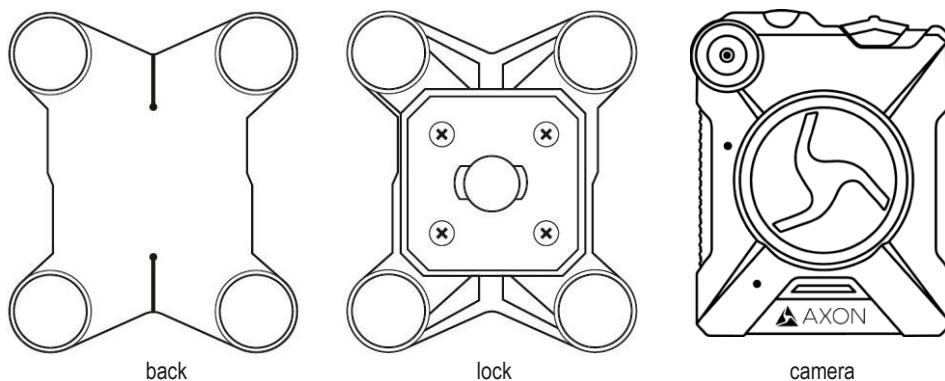

Assembly and Use

Read *Important Safety and Health Information (Chapter 1)* before performing these steps.

- 1 Insert the key on the back of the Axon Body 2 camera into the lock.
- 2 Twist the RapidLock mount counterclockwise, 90 degrees.
- 3 Place the magnetic back underneath the shirt, patrol vest, or whatever you are using.
- 4 Hold the back in place, and place the RapidLock mount over the back. Magnetic attraction will hold the camera in place.

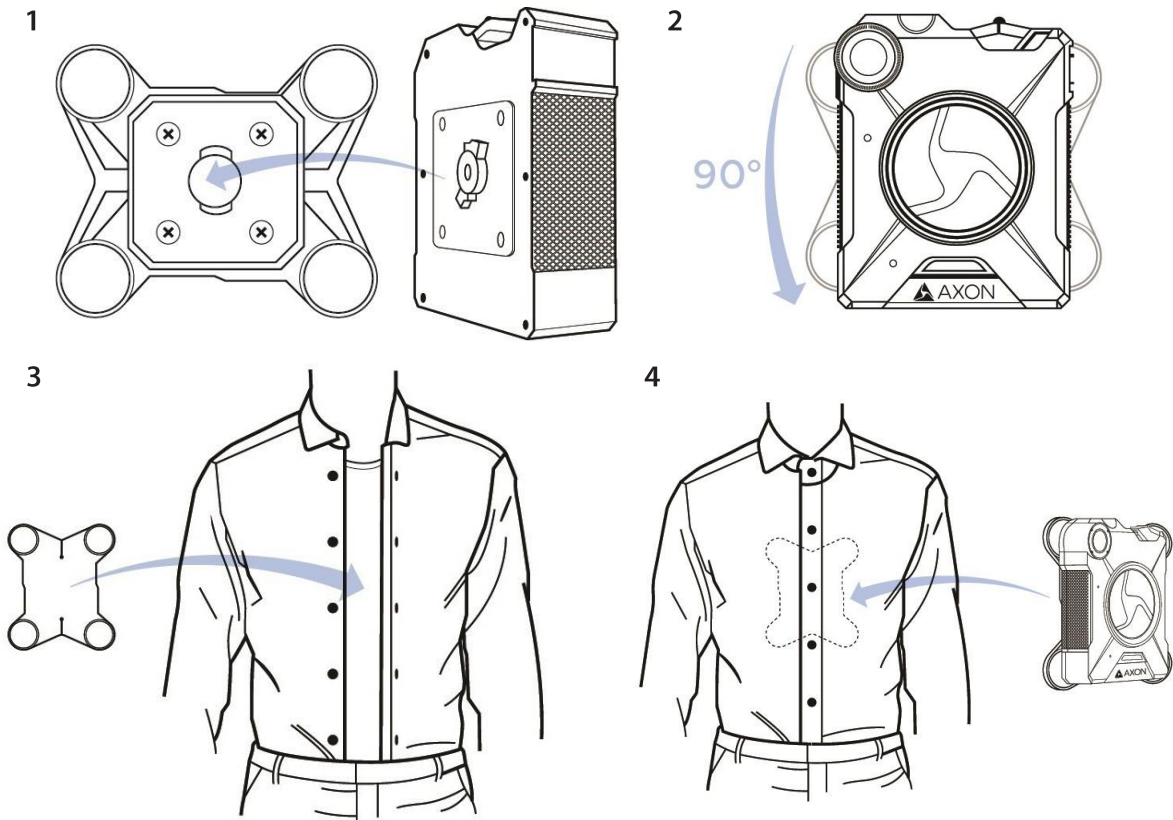

When you are wearing the camera, you can use the Axon View application's live streaming feature to determine whether your camera is capturing the view you intended.

Chapter 3: Recording with the Axon Body 2 Camera

Operating Modes

The Axon Body 2 camera has 2 operating modes:

- 1 BUFFERING (turning on the camera and starting pre-event buffering)
- 2 EVENT (event recording)

BUFFERING Mode (Turning on the Camera)

- 1 Move the ON/OFF switch on the camera to the ON position.

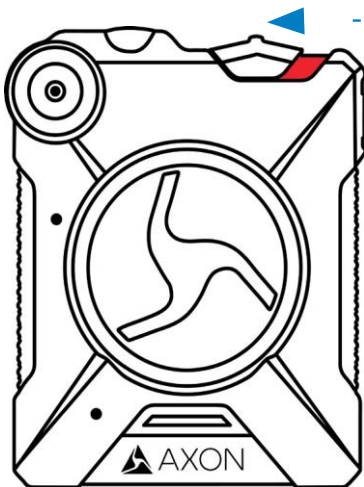

With the camera turned on, the Axon system is in the BUFFERING mode. When BUFFERING begins:

- The Operation LED on the camera will blink green.
- The camera will be capturing video but no audio, and will not record to permanent memory while in BUFFERING mode.
- Buffered video duration is 30 seconds by default (00:00:30).

When you activate the EVENT mode, the buffered video (not audio) captured directly before the event, up to 30 seconds, will be saved and attached to the event in permanent memory. This feature is intended to capture the video of an incident just before your activation of EVENT mode.

With default settings, the system does not capture audio in BUFFERING mode, so anything recorded in that mode will be video-only. Buffering mode starts only after the Axon Body 2 camera is turned on. The system does not record when the camera is turned off.

Notes:

- An agency can turn off the BUFFERING mode. If your agency has deactivated the BUFFERING mode, your Axon system will operate the same way as described in this manual, but the camera will not record anything until you double-press the EVENT button.
- An agency can extend the BUFFERING mode's duration to 2 minutes total (00:02:00).
- An agency can configure the BUFFERING mode so it records sound as well as video.

EVENT Mode (Starting Recording)

- 1 When you need to record, quickly double-press the EVENT button on the camera.

The system now records audio as well as video. The "buffered" video directly preceding the event will be saved and attached to the event recording. (Remember, with default settings, the buffered video will not contain audio.) The moment you double-press the EVENT button, both video and audio will be recorded from the camera and GPS coordinates (if the system is paired to a GPS-capable smart phone) will be recorded. This will continue throughout the duration of the recording until you terminate the recording.

The camera provides you with indications that it is recording in EVENT mode:

- At the start of an event and every 2 minutes during an event, the system will beep twice.
 - The Operation LED on top of the camera will blink red.
- 2 To stop recording and return to BUFFERING mode, press and hold the EVENT button for approximately four seconds. The system will beep once (with a longtone).
 - 3 To end a recording and turn off the system, move the on/off switch to the "off" position. When you end a recording with the on/off switch you will not go into BUFFERING mode; instead the system will turn off completely.

Note: An event not recorded by the camera cannot be played back or downloaded to your computer.

Muting Audio Recording

If your system administrator has configured your Axon system to do so, you can use the function button to disable audio recording during an event. This feature may be useful in sensitive situations.

- 1 Press and hold the Function button for 3 seconds to mute the audiocapture.
The function LED will flash blue while the camera is muted.
- 2 Press and hold the Function button another 3 seconds to re-enable the audiorecording.

Adding Markers to Recorded Video

The Function button also can be used to add a marker to recorded video that will show when the video is replayed on Evidence.com and documented in the audit trail for the device. Markers are most useful for documenting a moment that you will want to jump to quickly at a later time when re playing the video. If you want to add a marker to a video while you are recording:

- Press and release the Function button within 1 second.

Battery Status

Press the Battery button to determine the percentage remaining in the battery. See *Chapter 2: Getting to Know Your Axon Body 2 Camera* for details on the Battery LED functions.

Configuring Your Axon Camera

Adjusting the Audio Prompt Volume

- 1 Connect the Axon Body 2 camera to the Evidence Sync application.
- 2 Select the device settings.
- 3 Select the desired volume settings for the audio beeps recorded by the device.

The volume has 4 settings. At each level, the camera beeps, providing you with a sample of the volume:

- Low
- Medium
- High
- Off

Turning off the Camera LEDs (Stealth Mode)

For some situations, you may wish to turn off the lights on your camera. You can turn off the lights through the Evidence Sync software or by using the Battery button. To turn the lights off using the Battery button:

- Press and hold the Battery button for 10 seconds.

To turn the lights back on:

- Press and hold the Battery button for 10 seconds.

To use Evidence Sync:

- 1 Connect the Axon Body 2 camera to the Evidence Sync application.
- 2 Select the device settings.
- 3 Select the option to turn off the device LEDs.
 - The Operation LED flashes red, yellow, and then green before shutting down the lights.
 - Pressing the Battery button will momentarily light both the Operation LED and the Battery LED, displaying the current operating mode and battery level. For interpreting the LED colors, see *Chapter 2: Getting to Know Your Axon Body 2 Camera*.

To turn the lights back on:

- 1 Connect the Axon Body 2 camera to the Evidence Sync application.
- 2 Select the device settings.
- 3 Select the option to turn on the device LEDs.

Using Axon View

The Axon View application enables you to replay video and add metadata (GPS, title, case ID, and category) to your videos using a smart phone or multimedia player.

- 1 Using your smart device, download the Axon View application from the Google Play store or the iTunes App Store.
- 2 Search Axon View.
- 3 On your smart device, open the Axon View application and follow the onscreen instructions.

Pairing Your Axon Body 2 Camera with a Smart Device

Note: The Axon Body 2 camera is shipped with pairing enabled, but your administrator can turn the feature off.

- 1 Turn on the Axon Body 2 camera.

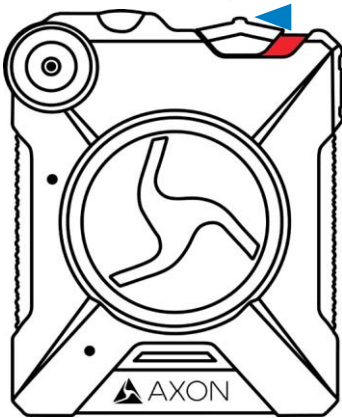

- 2 Hold down the Function and EVENT buttons for 5 seconds.

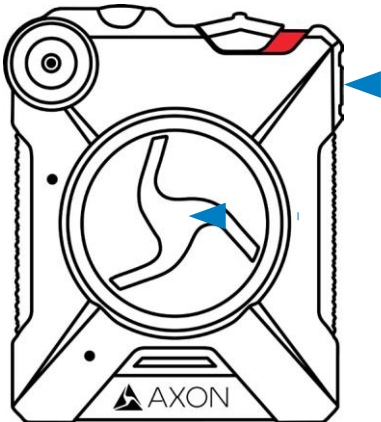

- 3 Wait until you hear 4 beeps. The Function LED will blink green.

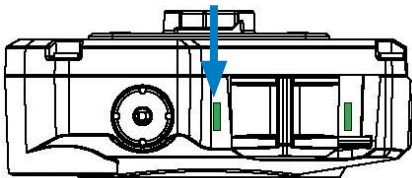

- 4 On your smart device, follow the onscreen instructions.

Configuring Your Camera to Use a Local Access Point (a Wi-Fi Connection) on Your iOS Device

Your Axon Body 2 camera can be set up to work with Apple devices using the iOS operating system (for example, the iPad, iPhone, and iPod). Previously, when pairing your Axon Body 2 camera to an iOS mobile device, you had to select the camera under the Wi-Fi settings. Now, you can pair your device to your camera without causing your mobile device to disconnect from its wireless network.

When performing this procedure, your Axon camera should not be plugged into a computer, or in an Axon Dock.

- 1 Move the ON/OFF switch on the camera to the ON position.

The Function LED will be solid blue.

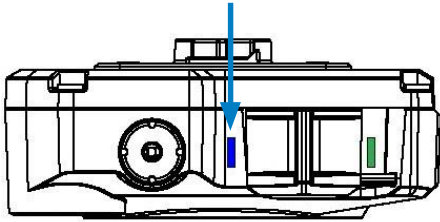

- 2 Press the Function and battery status buttons and hold them for about 10 seconds.

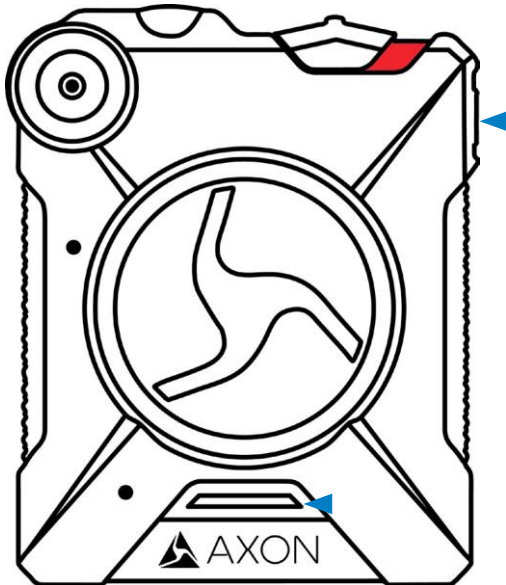

- 3 Press the Function and EVENT buttons and hold them for 10seconds.

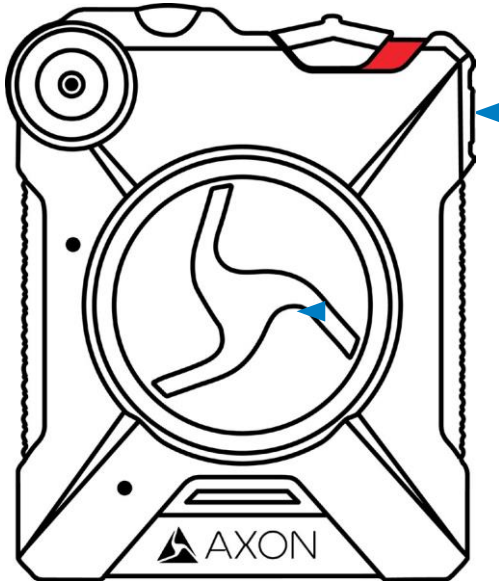

The Function LED will now blink magenta color. The device is now in the wireless accessory configuration (WAC) mode.

Note: It might take up to 2 minutes for the camera to go into WAC mode and the Function LED blink magenta. If the camera has not find a network after 30 minutes, the WAC mode will automatically turn off. Contact TASER customer service.

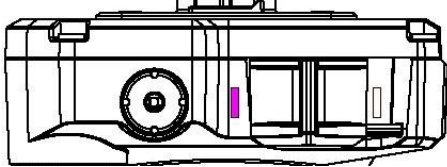

If you have previously configured the camera for WAC, when you turn the camera on again, the camera will try to join all the networks it connected to previously. The function LED will not blink Magenta. Instead, the camera will go into BUFFERING mode. If the camera cannot find a previously configured network, it will go into the WAC mode and the function LED will blink magenta.

If you turn on the camera and it is able to join a previously configured WAC network but you need to switch to a different network, you can still enter WAC mode by holding down the battery status button for 3 seconds while the camera is in BUFFERING mode. (You also can place the camera in WAC mode by holding down the status button after the function LED blinks magenta.)

Other Settings

Your organization's administrator can further configure your Axon Body 2 system with these features:

- Pre-event buffer of up to 2 minutes
- Axon Signal-enabled Bluetooth wireless technology
- Wi-Fi to pair your Axon Body 2 camera to the Axon View application

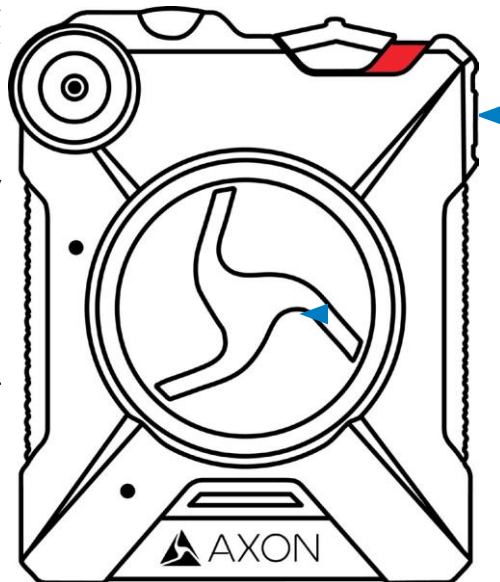

- Haptic (status notification via device vibration)
- Video quality

Chapter 4: Notification Reference Tables

Audio Prompts

The Axon Body 2 camera emits beeping sounds called “audio prompts” to notify you of the system status. These audio prompts usually occur after you perform an action with the body camera. These audio prompts are accompanied by a vibration that matches the beeps.

Operating Mode	Audio Notification	Haptic Notification (Vibration)
Powering on or off	One beep	Once
Recording an event	Two beeps (every 2 minutes)	Twice (every 2 minutes)
Press the Battery button while the camera is recording	Two beeps	None
The device is ending an event and returning to BUFFERING mode	One long beep	Once, long-duration
The battery is at 20 percent capacity or lower	Four quick beeps (every 5 minutes)	Four times, quickly, every 5 minutes
The camera memory is full	Three beeps. The camera will not start recording.	Three times

LED Status

Operation LED

Operating Mode	Operation LED
Recording	Blinking Red
Recovering interrupted video*	
Buffering	Blinking Green
Booting up/powering down	Solid Red
Error state**	

* When the Function LED also is blinking red.

** When the Function LED also is solid red.

Function LED

Function Enabled	Function LED
Mute (no audio capture)	Blinking blue
Camera error*	Solid red
Bluetooth feature is booting up	Solid blue
Wireless accessory configuration (WAC)	Blinking magenta

* Use the power switch to turn the camera off and on.

Battery LED

Battery Status	Battery LED
Battery capacity is 41–100 percent	Green
Battery capacity is 20–40 percent	Yellow
Battery capacity is less than 20 percent	Red during operation; flashing red and yellow during charging
Battery is critically low	Blinking red and yellow
BUFFERING mode (if configured)	Blinking green
EVENT mode (if configured)	Blinking red

Upload Status LED

System Status	LED Indication
Initial connection (momentary)	Solid red (for 20 seconds or fewer)
In queue awaiting upload	Solid yellow
Device ready (all videos uploaded successfully) and fully charged	Solid green
Device not assigned, agency mismatch, camera set in the offline mode, or device error	Blinking red
Uploading data	Blinking yellow – DO NOT remove the camera from the Axon Dock
Firmware update, internal battery charging, extremely low battery, or memory full	Blinking red and yellow – DO NOT remove the camera from the Axon Dock
Transfer error, device re-trying to transfer	Blinking green and yellow
Network error (no connection)	Blinking red, yellow, and then green (cycling all colors)
Axon Dock has no communication with the camera. Contact TASER customer service.	LED off

Chapter 5: Axon Signal Operations

Axon Signal technology is included with the Axon Body 2 camera. However, your agency's administrator must have activated the Axon Signal capability for it to work.

When it is active, Axon Signal technology takes your Axon Body 2 camera from BUFFERING to EVENT mode automatically.

Emergency vehicles can be equipped with an Axon Signal Unit (ASU). With light bar activation, or other activation triggers, the ASU sends a signal to your Axon Body 2 camera. Upon processing this signal, your Axon camera transitions from BUFFERING to EVENT mode. When your camera starts recording, you will hear two beeps.

The ASU has a range of approximately 30 feet (9.1 meters). Another vehicle's light bar activation may cause your Axon camera to start recording if the light bar is equipped to do so.

The ASU can only send a signal to tell the camera to start recording. Axon Signal technology does not end recording. If a light bar is turned off, the camera will continue to record.

The ASU cannot turn an Axon system on. If the Axon Body 2 camera is turned off, the camera will not record even if an ASU sends an activation signal.

The ASU is purchased separately from the Axon Body 2 camera.

Chapter 6: Care and Maintenance

Cleaning the Axon Body 2 Camera

Use a soft, damp cloth to clean the surface of the Axon Body 2 camera. Do not use harsh cleaners or solvents.

Do not immerse the Axon Body 2 camera in water or cleaning solutions.

If the Axon Body 2 camera lens becomes dirty, use a lens blower brush to clean it and then wipe it with a soft cloth if necessary.

You may moisten the cloth with isopropyl alcohol.

- Do not use ammonia-based or similar type window cleaners on the camera lens.
- Do not place the lens under running water or apply jets of water to the camera lens.

Charging the Battery

A fully charged camera battery should provide enough power for approximately 12 hours of normal operation. Recharging a battery after a 12-hour use can take up to 6 hours if you are recharging your Axon Body 2 camera from a wall outlet or Axon Dock. Recharging could take considerably longer if you are recharging from a computer.

If the battery depletes significantly during use, you will hear 4 quick tones repeating every 5 minutes. This message indicates that less than approximately 20 percent of the battery capacity remains.

Always recharge a depleted battery as soon as reasonably possible. You can use an Axon Dock, wall charger, or computer to charge the battery. Using a non-TASER approved wall charger may degrade device performance and will void the warranty.

If the Axon Body 2 camera is to be stored for a long time, the Battery LED should be yellow when you put the camera in storage. After an Axon Body 2 camera has been stored 6 months, the camera should be run until the battery is depleted and then the battery should be recharged.

Replacing the Battery

Replacement batteries are combined with the back portion of an Axon Body 2 camera. Replacing a battery involves removing the back of the camera and installing a new camera back.

- 1 Turn the Axon Body 2 camera off.
- 2 Using a Torx T6 screwdriver, remove the screws from the Axon Body 2 camera.

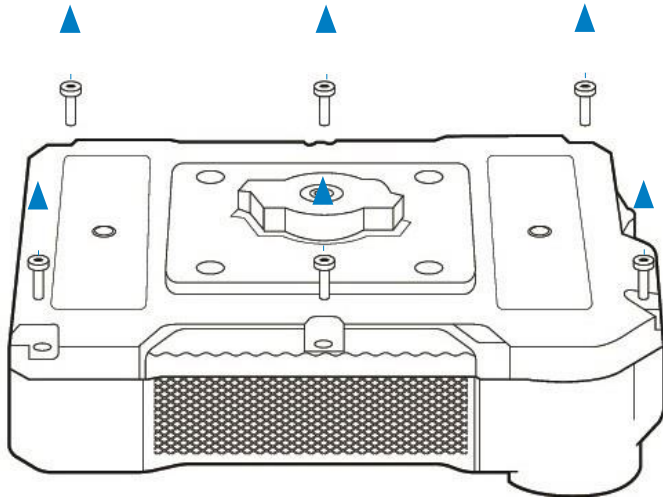

- 3 Remove the back of the camera.

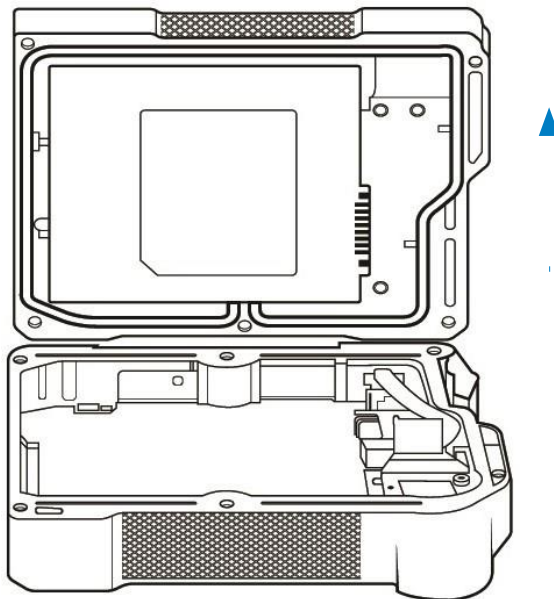

- 4 Put the new camera back in place with the camera front.
- 5 Using a Torx T6 screwdriver, fasten the screws into the new camera back. Do not over-tighten.

Chapter 7: Troubleshooting

If you experience difficulty with your Axon Body 2 camera, first power the device down, and start it again.

If experiencing difficulty with the Axon View application, power down the mobile device, turn the device back on, and re-pair your smart device with the Axon Body 2 camera.

Customer Service

Visit www.taser.com and view the Support options, or call 1-800-978-2737.

Warranty Policy

TASER International warranty provisions are applicable on all Axon Body 2 system products. See TASER International's website, www.taser.com, for detailed warranty information.

Warnings

For a full list of the warning associated with this product, see www.taser.com.

Radio Waves



Changes or modifications to the equipment not expressly approved by the manufacturer could void the product warranty and the user's authority to operate the equipment.

Your wireless device is a radio transmitter and receiver. It is designed and manufactured not to exceed the emission limits for exposure to radio frequency (RF) energy set by the Federal Communications Commission (FCC) of the U.S. Government. These limits are part of comprehensive guidelines and establish permitted levels of RF energy for the general population. The guidelines are based on standards that were developed by independent scientific organizations through periodic and thorough evaluation of scientific studies. The standards include a substantial safety margin designed to assure the safety of all persons, regardless of age and health. Before a device model is available for sale to the public, it must be tested and certified to the FCC that it does not exceed the limit established by the government-adopted requirement for safe exposure. This equipment has been tested and found to comply with the limits for a Class B digital device, pursuant to part 15 of the FCC Rules. These limits are designed to provide reasonable protection against harmful interference in a residential installation. This equipment generates, uses and can radiate radio frequency energy and, if not installed and used in accordance with

the instructions, may cause harmful interference to radio communications. However, there is no guarantee that interference will not occur in a particular installation. If this equipment does cause harmful interference to radio or television reception, which can be determined by turning the equipment off and on, the user is encouraged to try to correct the interference by one or more of the following measures:

Reorient or relocate the receiving antenna.

- Increase the separation between the equipment and receiver.
- Connect the equipment into an outlet on a circuit different from that to which the receiver is connected.
- Consult TASER International Customer Service for help.

FCC/IC NOTICE: This device meets the body worn human exposure limits found in OET Bulletin 65, 2001, and ANSI/IEEE C95.1, 1992. Proper operation of this equipment according to the instructions found in this guide will result in exposure substantially below the FCC's recommended limits. To comply with the FCC and ANSI C95.1 RF exposure limits, this device has been tested for compliance with FCC RF Exposure limits in the typical configuration. The radiated output power of this wireless device is far below the FCC radio frequency exposure limits.

This device complies with part 15 of the FCC Rules. Operation is subject to the following two conditions: (1) This device may not cause harmful interference, and (2) this device must accept any interference received, including interference that may cause undesired operation.

RSS 210 Warning Statement: The installer of this equipment must ensure that the antenna is located or pointed such that it does not emit RF field in excess of Health Canada limits for the general population; consult Safety Code 6, obtainable from Health Canada's Web site www.hc-sc.gc.ca/rpb.

This device complies with Industry Canada licence-exempt RSS standard(s). Operation is subject to the following two conditions: (1) this device may not cause interference, and (2) this device must accept any interference, including interference that may cause undesired operation of the device.

Le présent appareil est conforme aux CNR d'Industrie Canada applicables aux appareils radio exempts de licence. L'exploitation est autorisée aux deux conditions suivantes : (1) l'appareil ne doit pas produire de brouillage, et (2) l'utilisateur de l'appareil doit accepter tout brouillage radioélectrique subi, même si le brouillage est susceptible d'en compromettre le fonctionnement.

THIS MODEL DEVICE MEETS THE GOVERNMENT'S REQUIREMENTS FOR EXPOSURE TO RADIO WAVES.

Section 8.4 of RSS-GEN

This Device complies with Industry Canada License-exempt RSS standard(s). Operation is subject to the following two conditions: 1) this device may not cause interference, and 2) this device must accept any interference, including interference that may cause undesired operation of the device.

Cet appareil est conforme aux normes d'exemption de licence RSS d'Industrie Canada. Son utilisation est soumise aux conditions suivantes : 1) cet appareil ne doit pas causer de brouillage, et 2) doit accepter tout brouillage, y compris le brouillage pouvant entraîner un fonctionnement indésirable.

Section 8.3 of RSS-GEN

Under Industry Canada regulations, this radio transmitter may only operate using an antenna of a type and maximum (or lesser) gain approved for the transmitter by Industry Canada. To reduce potential radio interference to other users, the antenna type and its gain should be so chosen that the equivalent isotropically radiated power (e.i.r.p.) is not more than that necessary for successful communication.

Conformément à la réglementation d'Industrie Canada, le présent émetteur radio ne peut fonctionner qu'au moyen d'une antenne d'un seul type et d'un gain maximal (ou inférieur) approuvé pour l'émetteur par Industrie Can-

ada. Dans le but de réduire les risques de brouillage radioélectrique pour les autres utilisateurs, il faut choisir le type d'antenne et son gain de sorte que la puissance isotrope rayonnée équivalente (p.i.r.e.) ne dépasse pas celle requise pour établir une communication satisfaisante.

THIS MODEL DEVICE MEETS THE GOVERNMENT'S REQUIREMENTS FOR EXPOSURE TO RADIO WAVES.

CE Declaration of Conformity

TASER International declares that this Axon system is in compliance with the requirements and other relevant provisions of the RTT&E Directive 1999/5/EC regarding radio and telecommunications equipment and the Directive 2014/30/EU regarding electromagnetic compatibility. A copy of the original Declaration of Conformity can be found at www.taser.com.



Product functions and specifications may change without notice and the actual product may vary from the illustrations in this manual.

Android is a trademark of Google, Inc., Bluetooth is a trademark of Bluetooth SIG, Google Play is a trademark of Google, Inc., IOS is a trademark of Cisco Technology, Inc., iTunes is a trademark of Apple, Inc., Torx is a trademark of Acumen Global Technologies, Wi-Fi is a trademark of the Wi-Fi Alliance, and Windows is a trademark of Microsoft Corporation.

▲, ▲ AXON, Axon, Axon Body 2, Axon Dock, Axon RapidLock, Axon Signal, Axon View, Evidence.com, Evidence Sync, TASER, and ⚡ are trademarks of TASER International, Inc., some of which are registered in the US and other countries. For more information, visit www.taser.com/legal. All rights reserved. © 2016 TASER International, Inc.