

TOSHIBA

Leading Innovation >>>

User's Manual

TOSHIBA AT100

Introduction

Welcome and thank you for choosing a TOSHIBA product.

For your convenience, your TOSHIBA product is furnished with two guides:

- a Quick Start Guide, and
- this comprehensive PDF User's Manual.

We recommend to backup the User's Manual onto an external device.

Please backup your data that is saved in internal storage before updating the platform.

Table of Contents

Introduction	2
Check the components	6
Safety instructions	6
Getting Started & Grand Tour	
Getting Started	9
Grand Tour	14
Power conditions	18
Basic Operations & Home screen	
Using the Touch Screen	19
Getting to know the HOME screen	20
Opening and switching applications	21
Monitoring your tablet's status	21
Quick Settings	22
Managing Notifications	22
Locking your screen	23
Customizing the Home screen	23
Changing the Screen Orientation	25
Managing Tasks and Applications	25
Factory Reset	25
Connecting to networks	
Connecting to mobile networks	26
Connecting to Wi-Fi networks	27
Connecting to Bluetooth devices	28
Applications & Widgets	
Analog clock	31
Browser	31
Calculator	33
Calendar	33
Camera	34
Clock	35
Contacts	36
Downloads	37
Email	37

Gallery	38
TOSHIBA Media Player.	39
Music	40
Picture frame.	41
Service Station	41
TOSHIBA File Manager.	43
Online Manual	45
Settings	
Wireless & networks	46
Sound	47
Screen	47
Multimedia.	48
Location & security	48
Applications	49
Accounts & sync.	50
Privacy.	50
Storage	51
Language & input.	51
Accessibility	52
Date & time	52
About tablet.	52
Hardware & Options Operation	
Hardware	54
Optional devices.	61
TOSHIBA Tablet Dock	67
Optional accessories	72
Troubleshooting	
Problem solving process.	73
Hardware and system checklist	74
TOSHIBA Support.	76
Specifications	
Physical Dimensions	78
Environmental Requirements	78
Regulatory information	
Copyright.	79
Disclaimer	79
Trademarks	80
AVC/H.264 License Notice	81
FCC information	81
CE compliance	82

Indication of restrictions of use	82
Working environment	83
Additional environments not related to EMC	83
REACH - Compliance Statement	84
Following information is only valid for EU-member States:	84
Canadian regulatory information (Canada only)	85
Canada – Industry Canada (IC)	85
Wireless LAN and your Health	85

Check the components

Check to make sure you have all of the following items:

Hardware

- TOSHIBA AT100 Tablet
- AC adaptor and power cord (2-pin plug or 3-pin plug)
- Battery pack (installed in the tablet)
- Sleeve case (provided with some models)

Documents

- TOSHIBA AT100 Quick Start Guide
- Instruction Manual for Safety and Comfort

If any of the items is missing or damaged, contact your dealer immediately.

Safety instructions

- Always read the safety instructions carefully:
- Do not disassemble, modify, tamper with or repair your product. Disassembly, modification, tampering or repairing the product could cause fire or electric shock, possibly resulting in serious injury. Please contact an authorized Toshiba service provider for any repair service.
- When handling the power cable/cord, follow these precautions:
 - Never tamper with the power cable/cord or plug.
 - Never splice, alter, bend or twist a power cable/cord.
 - Never pull on a power cable/cord to remove a plug from a socket.
 - Never place heavy objects on a power cable/cord.
 - Never run a power cable/cord through a pinch point such as a door or window.
 - Never place a power cable/cord near a heat source.
 - Never use nails, staples or similar objects to fasten or attach cord in place.
 - Never attempt to disassemble or repair an AC adaptor.Doing any of the above may damage the cables, and/or result in a fire or electric shock, possibly resulting in serious injury.
- Always confirm that the power plug (and extension cable plug if used) has been fully inserted into the socket, to ensure a secure electrical connection. Failure to do so may result in a fire or electric shock, possibly resulting in serious injury.
- Be careful if you use a multiple connector. An overload on one socket could cause a fire or electric shock, possibly resulting in serious injury.

- If dust gets on the power plug connectors or connector base, turn the power off and disconnect the power plug. Then clean the connector and/or connector base with a dry cloth. Continuing to use the product without cleaning the power plug may result in a fire or an electric shock, possibly resulting in serious injury.
- Always use the TOSHIBA AC adaptor that was provided with your product, or use AC adaptors specified by TOSHIBA to avoid any risk of fire or other damage to the product. Use of an incompatible AC adaptor could cause fire or damage to the product possibly resulting in serious injury. TOSHIBA assumes no liability for any damage caused by use of an incompatible adaptor or charger.
- Never plug the AC adaptor into a power source that does not correspond to both the voltage and the frequency specified on the regulatory label of the unit. Failure to do so could result in a fire or electric shock, possibly resulting in serious injury.
- Never attempt to connect or disconnect a power plug with wet hands. Failure to follow this instruction could result in an electric shock, possibly resulting in serious injury.
- Never leave small parts such as covers, caps and screws within the reach of infants or small children. Swallowing a small part may cause choking and suffocation resulting in death or serious injury. If a part is swallowed, immediately take appropriate emergency action and consult a doctor.
- Never allow any liquids to spill into any part of your product, and never expose the product to rain, water, seawater or moisture. Exposure to liquid or moisture can cause electric shock or fire, resulting in damage or serious injury. If any of these eventualities should accidentally occur, immediately:
 1. Turn off the product.
 2. Disconnect the AC adaptor from the power plug socket and product.Do not turn on the power again, until you have taken the product to an authorized service center. Failure to follow these instructions could result in serious injury or permanent damage to the product.
- Never place your product or AC adaptor on a wooden surface, furniture, or any other surface that could be marred by exposure to heat since the product base and AC adaptor's surface increase in temperature during normal use.
- Always place your product or AC adaptor on a flat and hard surface that is resistant to heat damage.
- Never place your product where it will be exposed to excess heat, such as in direct sunlight, an unventilated vehicle or near a heater. This may result in a system failure, malfunction, loss of data or damage to the product.
- Never place your product in a location where it will be exposed to extremely low temperatures. This may result in a system failure, malfunction or loss of data.

- Never subject your product to sudden temperature variations. This may result in condensation, causing a system failure, malfunction or loss of data.
- Never operate your product on AC power during a thunderstorm. If you see lightning or hear thunder, immediately turn off the product. An electric surge caused by the storm, may result in a system failure, loss of data or hardware damage.
- Always use the battery pack supplied as an accessory or an equivalent battery pack specified in the User's Manual. Other battery packs have different voltage and terminal polarities. Use of non-conforming battery packs could generate smoke or cause fire or rupture, possibly resulting in serious injury.

Getting Started & Grand Tour

This chapter provides an equipment checklist, grand tour of your tablet and basic information to start using your tablet.



Some of the features described in this manual may not function properly if you use an operating system that was not pre-installed by TOSHIBA.

Getting Started



- All users should be sure to read the section [Initial Setup](#).

This section provides basic information to start using your tablet. It covers the following topics:

- Connecting the AC adaptor
- Turning on the power
- Initial Setup
- Turning off the power



- *Use a virus-check program and make sure it is updated regularly.*
- *Never format storage media without checking its content - formatting destroys all stored data.*
- *It is a good idea to periodically back up main storage device to external media. General storage media is not durable or stable over long periods of time and under certain conditions may result in data loss.*

Connecting the AC adaptor

The AC adaptor can automatically adjust to any voltage ranging from 100 to 240 volt and to a frequency of either 50 or 60 hertz, enabling you to use this product in almost all country/region. The adaptor converts AC power to DC power and reduces the voltage supplied to this tablet.

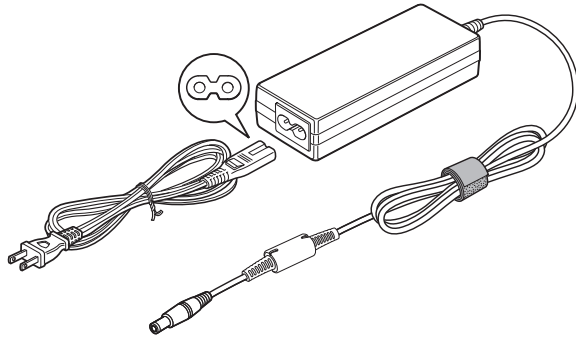

(Sample Illustration) The AC adaptor (2-pin plug)

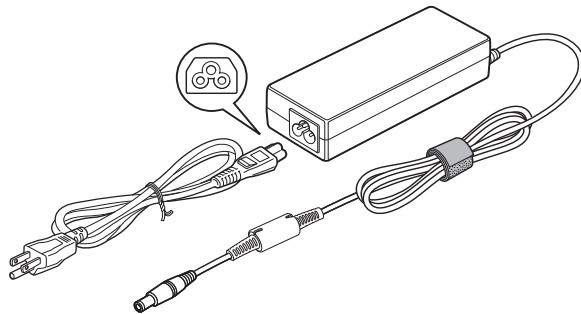

(Sample Illustration) The AC adaptor (3-pin plug)



- *Depending on the model, either a 2-pin or 3-pin adaptor/power lead will be bundled with the tablet.*
- *Do not use a 3-pin to 2-pin conversion plug.*
- *The supplied power cord conforms to safety rules and regulations in the region the tablet is bought and should not be used outside of this region. In order to use the adaptor/tablet in other regions, you should buy a power cord that conforms to the safety rules and regulations in that particular region.*

Attach the AC adaptor when you need to charge the battery or you want to operate from AC power. It is also the fastest way to get started, because the battery pack will need to be charged before you can operate from battery power.



- *Always use the TOSHIBA AC adaptor that was included with your tablet, or use AC adaptors specified by TOSHIBA to avoid any risk of fire or other damage to the tablet. Use of an incompatible AC adaptor could cause fire or damage to the tablet possibly resulting in serious injury. TOSHIBA assumes no liability for any damage caused by use of an incompatible adaptor.*
- *Never plug the AC adaptor into a power source that does not correspond to both the voltage and the frequency specified on the regulatory label of the unit. Failure to do so could result in a fire or electric shock, possibly resulting in serious injury.*
- *Always use or purchase power cables that comply with the legal voltage and frequency specifications and requirements in the country of use. Failure to do so could result in a fire or electric shock, possibly resulting in serious injury.*
- *Do not use a 3-pin to 2-pin conversion plug.*
- *When you connect the AC adaptor to the tablet, always follow the steps in the exact order as described in the User's Manual. Connecting the power cable to a live electrical outlet should be the last step otherwise the adaptor DC output plug could hold an electrical charge and cause an electrical shock or minor bodily injury when touched. As a general safety precaution, avoid touching any metal parts.*
- *Never place your tablet or AC adaptor on a wooden surface, furniture, or any other surface that could be marred by exposure to heat since the tablet base and AC adaptor's surface increase in temperature during normal use.*
- *Always place your tablet or AC adaptor on a flat and hard surface that is resistant to heat damage.*

1. Connect the power cord to the AC adaptor.
2. Connect the AC adaptor's DC output plug to the DC IN 19V jack on the tablet.
3. Plug the power cord into a live wall outlet - the **Battery** indicator on the display panel of the tablet should glow.

Turning on the power

This section describes how to turn on the power - the **Power** and **Battery** indicators will then indicate the status.

Press the power button on the tablet to turn on the power.

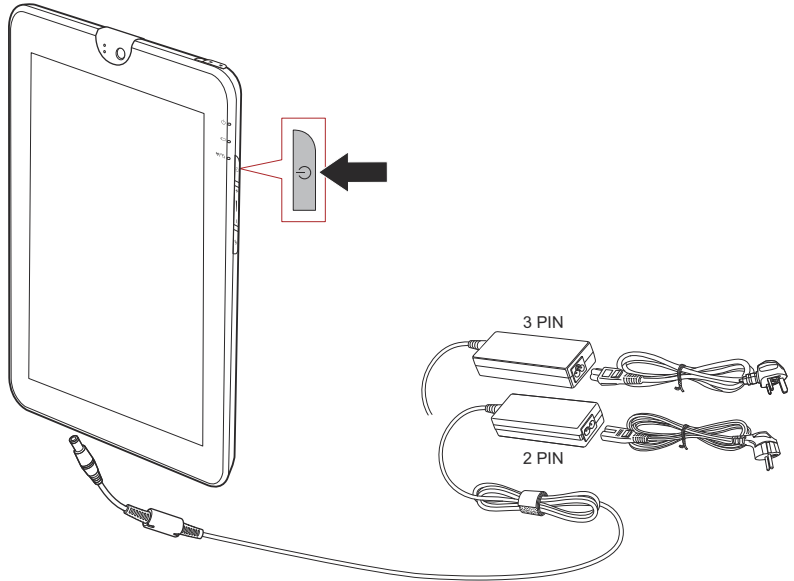

(Sample Illustration) Turning on the tablet

Initial Setup

The Setup Screen will be the first screen displayed when you turn on the power. Setup your tablet according to the following steps:

1. Choose the language as you want and then tap **Start** to continue.
2. Connect via Wi-Fi or 3G (if an option).
You may also skip this section and turn Wi-Fi on later in **Settings** screen.
3. Choose Google location service and tap **Next** to continue.
4. Set date and time, and tap **Next** to continue.
5. Register or log in with a Google account. You may also skip this section by tapping **Cancel**.

Turning off the power

If you are not going to use your tablet for a long time, shut it down. You can also turn the LCD off in order to extend the battery life.

Shut Down the Tablet

When you shut down the tablet, no data will be saved. The tablet will boot to the main screen when the next time it is turned on.

1. If you have entered data, either save it to flash memory or to other storage media.
 - Press the **Power** button for 2 seconds and select **OK** to turn off the tablet.



- *Never turn off the power while an application is running. Doing so could cause loss of data.*
- *Never turn off the power, disconnect an external storage device or remove storage media during data read/write. Doing so can cause data loss.*
- *In any emergency case, you can also press the power button for about six seconds to force power off.*

2. Turn off any peripheral devices connected to the TOSHIBA AT100 tablet.



Do not turn the tablet or peripheral devices back on immediately - wait a short period to avoid any potential damage.

Turning the LCD off/on

You can turn the LCD off (while the system is still on) in one of the following ways:

- Press the power button.
- Set the screen timeout in the **Settings**.

To turn the LCD on:

- Press the power button again.

Unlocking your screen

After turning on the LCD, the screen remains locked. You can unlock the screen in the following ways:

1. Tap and hold the unlock icon ().
2. Slide the icon towards the appearing circle.

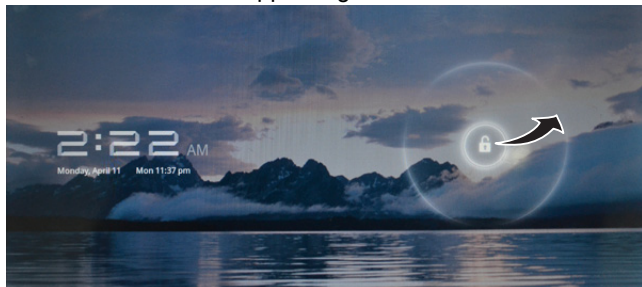

If you have set up a screen lock through one of the three ways as pattern, PIN or password, the method of unlocking the screen will be different. See [Location & security](#) section for other ways to protect your tablet and privacy.

Grand Tour



Please handle your product carefully to avoid scratching or damaging the surface.



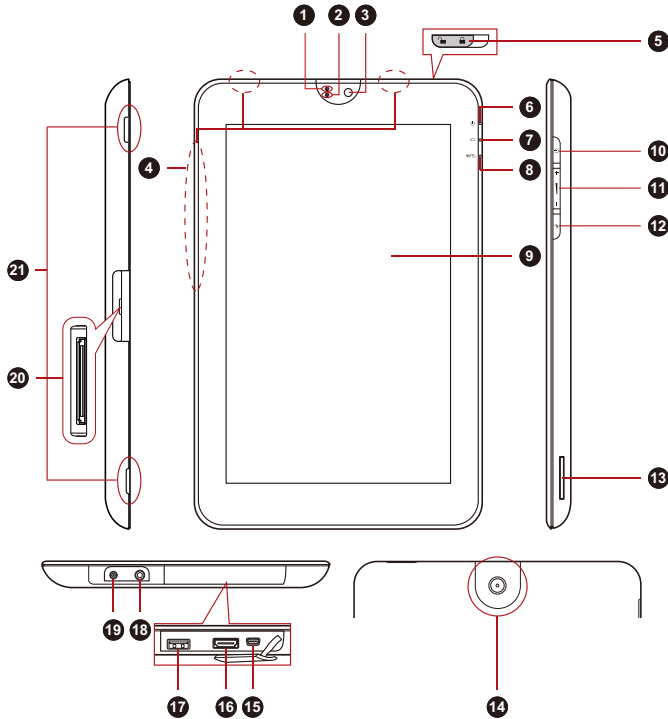

The following figure shows the grand tour of your tablet.



- | | |
|---|---|
| 1. Web Camera LED | 12. Orientation lock switch |
| 2. Microphone | 13. Memory media slot |
| 3. Web Camera (front) | 14. Web Camera (back) |
| 4. Wireless LAN, 3G* and Bluetooth antennas (not shown) | 15. Mini USB port |
| 5. Battery cover lock | 16. HDMI port |
| 6. Power indicator | 17. Universal Serial Bus (USB) 2.0 port |
| 7. Battery indicator | 18. Headphone/Microphone combo jack |
| 8. Wi-Fi/3G indicator | 19. DC IN 19V jack |
| 9. Display screen | 20. Docking interface |
| 10. Power button | 21. Speakers |
| 11. Volume down/up buttons | |

*Provided with some models.

(Sample Illustration) Grand tour of the tablet

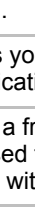
	Web Camera LED	The Web Camera LED will glow blue when the Web Camera is in operation.
	Microphone	A built-in microphone allows you to import and record sounds for your application.
	Web Camera	Your tablet is equipped with a front Web Camera and a back Web Camera used for recording video or taking photographs with your tablet.
	Wireless LAN antennas	Some models are equipped with Wireless LAN antennas.
	Battery cover lock	Slide this lock to the unlock () position in order to remove the battery cover.
	Power indicator	The Power indicator LED normally glows white when the tablet is turned on and the AC adaptor is connected.
	Battery indicator	The Battery indicator shows the status of the battery's charge - white indicates the battery is fully charged while the power is being correctly supplied from the AC power adaptor. For details, please refer to Power conditions section.
	Wi-Fi/3G indicator	This indicator glows amber when the communication function is used.
	Display screen	Display screen brightness can be adjusted in the Screen settings.
	3G antennas	Some models are equipped with the 3G antennas.
	Bluetooth antenna	Some models are equipped with a Bluetooth antenna.
	Power button	Press this button to turn the tablet's power on and off.
	Volume down/up buttons	Press these buttons to increase or decrease the volume.



Orientation lock switch Switch to lock/unlock automatic rotation of the screen orientation.



Memory media slot This slot lets you insert an SD™/SDHC™/SDXC™ memory card, a miniSD™/microSD™ Card and a MultiMediaCard.

Please refer to the [Memory media slot](#) section in "Hardware & Options Operation" chapter for details.



Keep foreign metal objects, such as screws, staples and paper clips, out of the memory media slot. Foreign metal objects can create a short circuit, which can cause damage and fire, possibly resulting in serious injury.



Mini USB port

Mini USB port allows you to connect this tablet to your computer, which can be used to transfer files.

Please refer to the [Mini USB port](#) section in "Hardware & Options Operation" chapter for details.



HDMI port

HDMI port can connect with Type A connector HDMI cable.

You can send video and audio signals via HDMI cable. In addition to this, you can send and receive control signals via it.

Please refer to the [HDMI device](#) section in "Hardware & Options Operation" chapter for details.



Universal Serial Bus (USB 2.0) port

One Universal Serial Bus port, which complies to the USB 2.0 standard, is provided.

Please refer to the [USB device](#) section in "Hardware & Options Operation" chapter for details.



Keep foreign metal objects, such as screws, staples and paper clips, out of the USB port. Foreign metal objects can create a short circuit, which can cause damage and fire, possibly resulting in serious injury.



Please note that it is not possible to confirm the operation of all functions of all USB devices that are available. In view of this it may be noted that some functions associated with a specific device might not operate properly.

**Headphone/
Microphone combo
jack**

A 3.5 mm mini headphone/microphone combo jack enables connection of a monaural microphone or a stereo headphone.

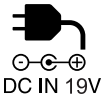
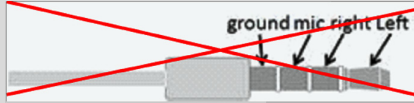

Both the internal and external microphones will be disabled if you use a headset other than a 4-pin headset headphone.

DC IN 19V jack

The AC adaptor connects to this jack in order to power the tablet and charge its internal batteries. Please note that you should only use the model of AC adaptor supplied with the tablet at the time of purchase - using the wrong AC adaptor can cause damage to the tablet.

Docking interface

The interface enables the connection of an optional dock described in [Hardware & Options Operation](#) chapter.

Speakers

The speakers emit sound generated by your software as well as audio alarms, such as low battery condition, generated by the system.

Power conditions

The tablet's operating capability and battery charge status are affected by different power conditions, including whether an AC adaptor is connected, whether a battery pack is installed and what the charge level is for that battery.



The LED in the table below refers to the **Battery** indicator.

		Power on	Power off (no operation)
AC adaptor not connected	Remaining battery capacity is above low battery trigger point	• LED: off	• LED: off
	Remaining battery capacity is below low battery trigger point	• LED: blink amber	
	No battery installed	• LED: off	
AC adaptor connected	Battery fully charged	• LED: white	• LED: white
	Battery partially charged	• LED: amber	• LED: amber
	No battery installed	• LED: off	• LED: off

Basic Operations & Home screen

This chapter describes the basic operations of your tablet and the Home screen.

Using the Touch Screen

You can use your finger to manipulate icons, buttons, menu items, the onscreen keyboard, and other items on the touch screen.

- **Tap**

Simply tap your finger on the touch screen to act on items on the screen, such as application and settings icons, to type letters and symbols using the onscreen keyboard, or to tap onscreen buttons.

- **Tap & hold**

Tap & hold an item on the screen by tapping it and not lifting your finger until an action occurs. For example, to customize the Home screen, you tap an empty area on the Home screen until the screen settings utility launches.

- **Drag**

Tap & hold an item for a moment and then, without lifting your finger, move your finger on the screen until you reach the target position. You can drag items on the Home screen to reposition them.

- **Swipe or slide**

To swipe or slide, you quickly move your finger across the surface of the screen, without pausing when you first touch it (so you don't drag an item instead). For example, you slide the screen up or down to scroll a list.

- **Double tap**

Tap quickly twice on a webpage, map or other screen to zoom.

- **Pinch**

In some apps (such as Browser and Gallery), you can zoom in/out by placing two fingers on the screen at once and pinching them together or spreading them apart.



Getting to know the HOME screen

The **HOME** screen is your starting point for using all the installed applications on your tablet. You can customize the **HOME** screen to display the widgets, application shortcuts, wallpapers and other shortcuts you prefer.



- | | |
|--------------------------|----------------|
| 1. Apps menu | 5. Back |
| 2. Customize | 6. Home |
| 3. Widgets | 7. Recent apps |
| 4. Application shortcuts | 8. System bar |

(Sample Illustration) Home screen

Item	Description
Customize	Add widgets, apps, wallpapers, and more to your Home screen.
Widgets	Widgets show you the latest updates of applications. You can tap the widgets to open these applications.
Application shortcuts	Tap these icons on Home screen to open applications.
 Back	Return to the previous screen.
 Home	Return to the home screen.
 Recent apps	See recent applications.

Item	Description
System bar	Show app notifications, tablet status and quick settings.
 Apps menu	See all your tablet's apps.

- Slide to see more **Home** screen panels.
- Use panels to organize your widgets and shortcuts. See [Customizing the Home screen](#) section for the details.
- To return to the center panel, tap **Home** button.

Apps menu

Tap the  icon at the upper right corner of **Home** screen to open **Apps menu**.

You can find all your apps in this place.

To manage your apps, tap **Settings** → **Applications** → **Manage applications**.

Opening and switching applications

The **Apps menu**, which you can open from the Home screen, holds icons for all the applications on your tablet.

- Tap **My apps** tab on the top of Apps menu screen to view applications that you downloaded and installed.

Opening an application

You may open any application by:

- Tapping an application icon on the **Home** screen
- Tapping an application icon from the **Apps menu**.

Switch to a recently used application

You may switch to recently used application by:

- Tapping **Recent apps** icon (), and select the application that you want to switch.

Monitoring your tablet's status

The status bar appears on the bottom of every screen. It displays time and icons indicating that you have received notifications and icons indicating the tablet's status, along with the current time.

Status icons

The icons on the right of the status bar indicate the status of your tablet.

Notification icons

The icons on the left of the status bar indicate different types of notifications. In addition to system notification icons, applications you installed on your tablet may use their own notification icons.

Quick Settings

You can use Quick Settings to change settings, such as **Airplane mode**, **Wi-Fi**, **Lock screen orientation**, **Brightness**, **Notifications**. Double tap the status bar to open Quick Settings screen, and tap the area outside of the Quick Settings screen to close it.

- **Airplane mode**

Turn on airplane mode to disable all wireless radios.

- **Wi-Fi**

Tap to open Wi-Fi Setting screen.

- **Lock screen orientation**

Turn on this option to lock screen orientation as you turn your tablet sideways.

- **Brightness**

Set the brightness of display. You can also tap **Auto** to adjust brightness automatically.

- **Notifications**

Turn on this option to show notification on system bar.

- **Settings**

Tap this option to open **Settings** screen.

Managing Notifications

Notification icons report the arrival of new messages, calendar events, and alarms, as well as ongoing events.

When you receive a notification, its icon appears in the status bar, along with a summary that appears only briefly.

You can open the Notifications panel to view a list of all your notifications. Depending on your settings and the model of your tablet, you may also hear a notification sound.

Adjusting sound volume and other general notifications settings is described in the [Sound](#) settings in "Settings" chapter.

Applications that produce notifications, such as Email, have their own settings, which you can use to configure whether and how they send notifications. See the sections on those applications for details.

Opening the Notifications panel

Tap the status bar to open the notifications panel. The notifications panel displays a list of your current notifications. Notifications about ongoing activities are listed first, followed by notifications about events, such as a new mail notifications.

Responding to a notification

To respond to a notification, follow the below steps:

1. Open the notifications panel.
Your current notifications are listed in the panel, each with a brief description.
2. Tap a notification to respond to it.
The notifications panel closes. What happens next depends on the notification.

Closing the Notifications panel

Tap the area out of the notifications panel to close the notifications panel.

Locking your screen

You can lock your screen so that only you can unlock it to access your data, run applications and so on. See [Location & security](#) section for other ways to protect your tablet and privacy.

Locking your screen with a Pattern lock

For example, you can use a Pattern lock to lock your screen with following steps.

1. Open the **Location & security** settings by tapping the **Apps** → **Settings** → **Location & security**.
2. Tap **Configure lock screen** → **Pattern**.

The first time you open it, a short tutorial about creating an unlock pattern will appear. Then you're prompted to draw and redraw your own pattern. Follow the onscreen instructions to finish the creation.

The next time you turn on your tablet or wake up the screen, you will be prompted to draw your unlock pattern to unlock the screen.

Customizing the Home screen

You can add application icons, shortcuts, widgets and other items to any part of the Home screen. You can also change the wallpaper.

Adding an item to the Home screen

To add an item to the Home screen, follow the steps listed below:

1. Tap the  icon at the upper right corner of the home screen.
2. Tap a tab of **Widgets**, **App shortcuts**, **Wallpapers** or **More**.
3. Drag the Widgets, shortcuts, or other items to the **Home** screen panel you want.



■ *You can also tap Widgets, shortcuts to add them to current Home screen panel.*

■ *The amount of Widgets you can add depends on the size of Widgets.*

■ Widgets

Add any of a variety of miniature applications (widgets) to your Home screen, including an analog clock, a music player, and a picture frame. You can also download widgets from other websites.

■ App shortcuts

Add shortcuts to applications you have installed.

■ Wallpapers

Add a wallpaper you like or change the wallpaper for your Home screen from the **Gallery**, **Live Wallpapers** or **Wallpapers**.

■ More

Add shortcuts to bookmarks, contacts, playlists and so on.

You can also add items to the **Home** screen by following ways:

- Tap and hold an empty area of the Home screen.
- Tap and hold an app shortcut on **Apps menu**, and drag it to the **Home** screen panel you want.

Moving an item on the Home screen

To move an item on the Home screen, follow the steps below:

1. Tap and hold the item you want to move until its icon is magnified. Don't lift your finger from the screen.
2. Drag the item to a new location on the screen.
It will pause at the left or right edge of the screen to drag the item onto extended Home screen.
3. When the item is at where you want it, lift your finger.

Removing an item from the Home screen

To remove an item from the Home screen, follow the steps below:

1. Tap and hold the item you want to remove until its icon is magnified.
A Trash bin icon appears on the top right corner.
2. Drag the item to the Trash bin icon.
3. When the icon glows red, lift your finger.

Changing the Screen Orientation

You can change the screen orientation to Portrait mode by rotating the tablet sideways. The screen orientation automatically changes according to the rotation angle detected.

You can also lock the auto rotation and use the tablet always in Portrait or Landscape mode. These settings can be performed in the **Screen** settings. Please refer to [Screen](#) section for details.



In the Portrait mode, some drivers/utilities may not perform install and uninstall operation. If it occurs, switch to the Landscape mode to proceed.

Managing Tasks and Applications

You can manage some of the running applications, please follow the steps below:

1. Tap **Apps** → **Settings** → **Applications** → **Manage applications**.
2. Tap an item you want to manage from **Downloaded/Running/All** tab.



Please refer to [Applications](#) in Settings section for details.

You can close an item by tapping **Force stop**, or remove an item by tapping **Uninstall**.



In order to improve the performance of your tablet, close some of the running applications.

Factory Reset

The tablet provides you with the function to reset it. Before executing this function, you need to backup the system settings, application settings, user installed applications and data in the internal storage.

To perform the factory data reset, please follow the steps below:

1. Tap **Apps** → **Settings** → **Privacy** → **Factory data reset** → **Reset tablet** → **Erase everything**.
2. The factory data reset will be done.



■ *Please note that the following data will be erased:*

- *System settings and application settings*
- *User installed applications*
- *Internal storage files, such as music or photos*
- *Data in the removable media will not be erased.*

Connecting to networks

Your tablet can connect to a variety of networks and devices, mobile networks for voice and data transmission, Wi-Fi data networks and Bluetooth devices, such as headsets. This chapter will describe how to connect to different networks.

Connecting to mobile networks



This section only applies to models with 3G modules.

When you assemble your tablet with a SIM card from your wireless service provider, your tablet is configured to use your provider's mobile networks for transmitting data.

Your tablet is configured to work with many mobile carriers' networks. If your tablet does not connect to a network when you insert a SIM card and turn it on, contact your carrier to obtain the details of its access point name.

Disabling data when roaming

1. Open the **Settings** screen.
2. Tap **Wireless & networks** → **Mobile networks**, and uncheck **Data roaming**.
With **Data roaming** unchecked, you can still transmit data with a Wi-Fi connection.

Editing or creating a new access point

If you and your wireless service provider determine that you need to change the settings of your current access point name (APN) or to create a new one, you must obtain the APN and detailed settings from your provider.

1. Open the **Settings** screen.
2. Tap **Wireless & networks** → **Mobile networks** → **Access Point Names**.
3. Tap an existing APN to edit it, or tap **New APN** to create a new one. Enter the APN settings that you obtained from your wireless service provider by tapping each setting that you need to edit.
4. When you finished, tap **Save**.
If you have created a new APN, tap it in the APNs screen to start using it.

Connecting to Wi-Fi networks



Wi-Fi is a wireless networking technology that can provide Internet access at distances of up to 100 meters, depending on the Wi-Fi router and your surroundings.

To use Wi-Fi on your tablet, you need to access a wireless access point, or “hotspot”. Some access points are open and you can simply connect to them. Others are hidden or implement other security features, so you must configure your tablet so it can connect to them.

There are numerous systems for securing Wi-Fi connections, including some that rely on secure certificates or other schemes to ensure that only authorized users can connect.

Turn off Wi-Fi when you are not using it to extend the life of your battery.

The Status bar displays icons that indicate Wi-Fi status.

	Connected to a Wi-Fi network (waves indicate connection strength)
	Notification that an open Wi-Fi network is in range

Turning Wi-Fi on and connecting to a Wi-Fi network

You may turn on and connect to a Wi-Fi network by following steps:

1. Open the **Settings** screen.
2. Tap **Wireless & networks**.
3. Tap **Wi-Fi** to turn it on.
The tablet scans for available Wi-Fi networks and displays the names of those it finds. Secured networks are indicated with a Lock icon.



If the tablet finds a network that you connected to previously, it will connect to it automatically.

4. Tap **Wi-Fi settings** and choose a network to connect it.
If the network is open, you are prompted to confirm that you want to connect to that network by tapping **Connect**.
If the network is secured, you're prompted to enter a password or other credentials. (Ask your network administrator for details.)
When you connected to a network, tap on the network name in the Wi-Fi settings screen for details about the speed, security, address, and related settings.

Receiving notifications when open networks are in range

By default, when Wi-Fi is turned on, you will receive notifications in the Status bar when your tablet detects an open Wi-Fi network.

1. Turn on Wi-Fi if it is not already on.
2. In the **Wi-Fi settings** screen, check **Network notification**.
You can uncheck this option to stop receiving notifications.

Adding a Wi-Fi network

You can add a Wi-Fi network so the tablet will remember it, along with any security credentials, and connect to it automatically when it is in range. You must also add a Wi-Fi network to connect to it, if it does not broadcast its name (SSID), or to add a Wi-Fi network when you are out of range.

To join a secured network, you need to contact the network's administrator to learn what security scheme is deployed on it and to obtain the password or other required security credentials.

1. Turn on Wi-Fi if it is not already on.
2. In the **Wi-Fi settings** screen, tap **Add Wi-Fi network**.
3. Enter the Network SSID (name). If the network is secured, tap the **Security** menu and then tap the type of security deployed on the network.
4. Enter any required security credentials.
5. Tap **Save**.

The tablet will connect to the wireless network. Any credentials that you enter will be saved, so you can connect automatically the next time you come within range of this network.

Forgetting a Wi-Fi network

You can make your tablet forget about the details of a Wi-Fi network that you added. For example, if you don't want the tablet to connect to it automatically or if it is a network that you no longer use.

1. Turn on Wi-Fi if it's not already on.
2. In the **Wi-Fi settings** screen, tap the name of the connected network.
3. Tap **Forget** in the dialog that opens.

Connecting to Bluetooth devices

Bluetooth is a short-range wireless communications technology that devices can use to exchange information over a distance of about 8 meters. The most common Bluetooth devices are headphones for making calls or listening to music, hands-free kits for cars, and other portable devices, including cell phones.



This tablet does not support Bluetooth connections via ad-hoc network.

To connect to a Bluetooth device, you must turn on your tablet's Bluetooth radio. The first time you use a new device with the TOSHIBA AT100 Tablet, you must "pair" them so that they know how to connect securely to each other. After that, you can simply connect to a paired device.

Turn off Bluetooth when you're not using it, to extend the life of your battery between charges. You may also be required to turn Bluetooth off in some locations. Bluetooth is turned off in Airplane mode.

Turning Bluetooth on or off

1. Open the **Settings** screen.
2. Tap **Wireless & networks**.
3. Check or uncheck **Bluetooth** to turn it on or off.

Changing your tablet's Bluetooth name

Your tablet has a generic Bluetooth name by default, which is visible to other devices when you connect them. You can change the name so that it is more recognizable.

1. Open the **Settings** screen.
2. Tap **Wireless & networks** → **Bluetooth settings**.
The Bluetooth settings screen will be displayed.
3. If Bluetooth is not turned on, check **Bluetooth** to turn it on.
4. Tap **Device name**. Enter a name and tap **OK**.

Pairing your tablet with a Bluetooth device

You must pair your tablet with another device before you can connect to it. Once you pair your tablet with another device, they stay paired unless you unpair them.

1. Open the **Settings** screen.
2. Tap **Wireless & networks** → **Bluetooth settings**.
3. If Bluetooth is not turned on, check **Bluetooth** to turn it on.
Your tablet will scan for and display the Bluetooth names of all available Bluetooth devices in range.
4. If the device you want to pair with is not included in the list, make it discoverable. See the documentation that came with your device to learn how to make it discoverable by your tablet, and for other instructions for pairing.
5. If your tablet stops scanning before you make the other device discoverable, tap **Scan for devices**.
6. Tap on the Bluetooth name of the device in the list in settings to pair them.
The devices pair with each other. If you're prompted to enter a passcode, try entering 0000 or 1234 (the most common passcodes), or consult the documentation that came with the device to learn its passcode. If the pairing is successful, your tablet connects to the device.

Connecting to a Bluetooth device

Once paired, you can connect to a Bluetooth device. For example, to switch devices or to reconnect after your TOSHIBA AT100 Tablet and this device come back into range.

1. Open the **Settings** screen.
2. Tap **Wireless & networks** → **Bluetooth settings**.

3. In the list of Bluetooth devices, tap a paired but unconnected device. If the device you expected isn't displayed, tap **Scan for devices**. When your tablet and this device are connected, this device is shown as connected in the list.

Disconnecting from a Bluetooth device

1. Tap the device in the Bluetooth settings screen.
2. Tap **OK** to confirm that you want to disconnect.

Unpairing a Bluetooth device

You can unpair a Bluetooth device to erase all pairing information related to a specific device.

1. Tap and hold the device in the Bluetooth settings screen.
2. Tap **Unpair** or **Disconnect & unpair** in the menu that opens.

Applications & Widgets

This chapter describes the applications & widgets and how to use them. Your tablet has some Google applications installed depending on the model you purchased.

Analog clock

Analog clock is a widget to display a clock in the Home screen based on the system time so that you can watch time directly from the clock.

You can also use it to set an alarm clock. For details, please refer to the [Clock](#) section.

Browser

Browser is used to view webpages and to search for information on the web.

To open the Browser, tap **Apps** → **Browser**.

Browser can also open when you tap a web link, for example, in an email or text message.

When you open Browser, the last webpage you were viewing is displayed. If you have not used Browser recently, your home page will open.

Go to a webpage

1. Tap the URL box on the top of the Browser screen.
If the URL box isn't visible, drag the page down until the URL box comes into view.
2. Enter the address (URL) of the webpage by using the onscreen keyboard.
3. Tap a suggestion or enter an address and tap **Enter** with the onscreen keyboard.

- *The **Browser** cannot display some webpages correctly if the web page has a complicated layout. This is dependent on the web page.*
- *The **Browser** does not support file uploading function.*
- *The **Browser** might connect to a “mobile” web site rather than a “PC” web site, depending on the site. If you want to access the PC web site, please manually select the correct site.*

Zoom in or zoom out on a webpage

You can zoom on a webpage in either of the following ways.

- Double tap at the area where you want to zoom.
- Pinch two fingers together or apart to zoom out or in on a webpage.

Multiple Browser tabs

You can open several Browser windows (up to eight) and switch among them with tabs.

Open a new Browser window

You may open a new Browser window in either of the following ways:

- Tap **Menu** () and select **New tab**.
- Tap the **+** with tabs.

New window will open with your home page.

Switch between Browser windows

You may switch between different Browser windows by tapping the tabs of browser windows.

Close a Browser window

You may tap the cross on the tab to close the current browser window.

Bookmarks

You may bookmark webs to open it conveniently.

1. Tap the pentagram icon () with the URL bar.
2. Enter a **Label** of the web or use a default **Label** of it.
3. Tap **OK** to add it to **Bookmarks**.
You can also add it to **Home screen** or **Other folder** by tapping and choosing from **Add to** menu.

You may open the web from the bookmarks.

1. Tap the bookmark icon () at the upper right corner of the screen to go to bookmarks.
2. Tap a page in the list to open it.

View your Browser history

As you browse the web, Browser will keep track of the pages you visit, to help you find your way back later.

1. Tap the bookmark icon () at the upper right corner of the screen.
2. Tap the **History** tab.
The pages you've visited are grouped chronologically. Bookmarked pages have a gold star.
3. Tap a time period to view the pages you've visited.
4. Tap a page in the history to reopen it.

Web page options

By tapping **Menu** (), you can access a number of settings to manage related web page settings: **New tab**, **New incognito tab**, **Find on page**, **Share page**, **Page info**, **Downloads**, **Settings**.

Browser settings

You can configure a number of Browser settings, including some that you can use to manage your privacy.

To open the Browser settings screen, tap **Menu** () → **Settings**.

There are four tabs: **General**, **Privacy & Security**, **Advanced** and **Labs**.

Calculator

You can use **Calculator** to solve simple arithmetical problems or use its advanced operators to solve more complex equations.

1. Open Calculator as follows:
Tap **Apps** → **Calculator**.
2. Enter numbers and arithmetical operators on the basic screen.
3. Tap and hold the Calculator's display to copy the numbers.
4. Tap **Clear** icon () to delete the last number or operator you entered.
Tap **CLR** to delete everything in the display.

Calendar

You can use **Calendar** to remind your date.

Add events to Calendar

You can add events to **Calendar** by following these steps:

1. Tap any blank period on your calendar or the **New Events** icon () on the top right corner of **Calendar** screen.
2. Enter **Event name** and set details for this date.
You can add guests by entering their email addresses.
3. Tap **Done** to save.

Camera

Camera is a combination of camera and camcorder that you use to shoot and share pictures and videos. Pictures and videos are stored in the Gallery.

Open Camera and take pictures/videos

You can take pictures and shoot videos with the Camera.

To open the Camera, tap **Apps** → **Camera**.

Camera will open, ready to take a still picture. You can switch **Camera** to video mode anytime to shoot a video.

The back camera is set for default. You can change to front camera by tapping  icon.

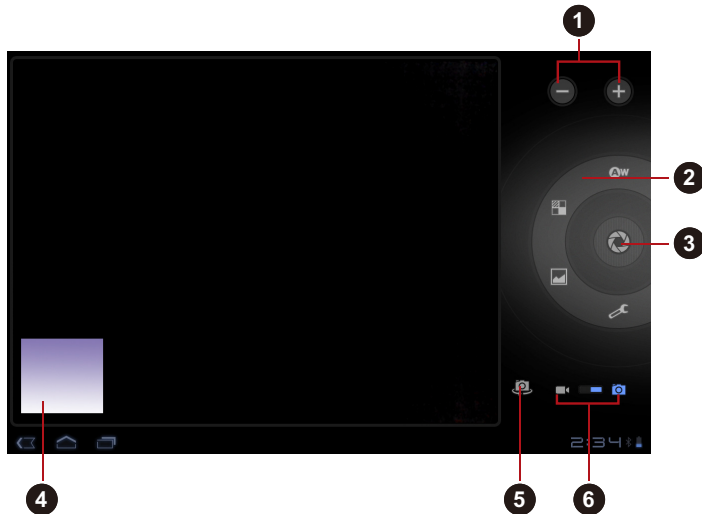

- | | |
|-------------------------|----------------------------------|
| 1. Digital zoom in/out | 4. Go to the gallery |
| 2. Change photo options | 5. Change camera (front or back) |
| 3. Take a photo | 6. Choose photo or video mode |

(Sample Illustration) Camera screen

Review your pictures/videos

You can review the pictures/videos you've taken in **Camera**.

- Tap the thumbnail image on the bottom left of the Camera screen to open the **Gallery**.

For details, refer to the [Gallery](#) section.

Photo options

Many options are displayed on the screen.

- **White balance**: Adjust for lighting conditions.
- **Color effect**: Pick a cool effect.
- **Scene mode**: Choose your environment.
- **Camera settings** (): Choose general settings like **Store location**, **Exposure**, **Picture size**, **Picture quality**.

Store location

Turn on to add location information to pictures you take.

Exposure

Adjust the value to change the exposure rate.

Picture size

Choose the size of the pictures you take.

Picture quality

Choose the quality of the pictures you take.

Video options

As in Video mode, Video options are displayed on screen.

- **White balance**: Adjust for lighting conditions.
- **Color effect**: Pick a cool effect.
- **Video quality**: Tap to select the quality of the videos you take.
- **Time lapse interval**: Create a time lapse clip.

Clock

In addition to displaying the date and time, the **Clock** application plays slideshows and music. You can also use Clock to set an alarm clock.

To open Clock, tap **Apps** → **Clock**.

Setting an alarm

1. Tap the Alarm icon () below the time display.
2. Tap an existing alarm clock to change its time and other attributes. Or tap **Add alarm** to add a new one.
3. Tap **Time** to set the time of the alarm.

4. Tap **Repeat** to set the days when you want the alarm to sound. If you don't set a repeat, the alarm sounds only one time.
5. Tap **Ringtone** to select a ringtone for the alarm. The ringtone plays briefly when you select it.
6. Tap **Label** to enter a name for the alarm.
7. When you finished, tap **Done**.

Contacts

Contacts gives you quick and easy access to the people you want to reach. Information about your contacts is shared with other applications, such as Messaging, Gallery (for sharing photos and videos) and so on.

If you have more than one account with contact information, **Contacts** merges duplicate contacts into a single entry. You can also manage that process manually.

Open Contacts

To open your contact, tap **Apps** → **Contacts**.

All of your contacts are displayed alphabetically in a scrolling list.

Tap a contact to view the details. Entries for communicating with the contact are followed by details. Tap a communication method to start texting or emailing the contact by using the listed number, address and so on.

Import and export contacts

If you have contacts stored in vCard format in the Internal storage, you can import them into Contacts on your tablet. You can also copy contacts from SD card by TOSHIBA File Manager. You can export contacts in vCard format into the Internal storage and copy onto an SD card to backup using TOSHIBA File Manager. You can also send a contact via email or Bluetooth.

Search for a contact

You can search for a contact by name.

1. Open your **Contacts**.
2. Tap **Find contacts** (). The search box appears.
3. Start entering the name or number of the contact you're searching for. As you type, contacts with matching names appear below the search box.
4. Tap a matching contact in the list to open its details screen.

Display options

You can sort contacts list by First name or Last name.

1. Open your **Contacts**.
2. Tap **Menu** icon (☰) and then tap **Settings**.
3. Set **Sort list by** and **View contact names as**.

Edit or delete contacts

- To edit a contact, tap the contact, and then tap (✎).
- To delete a contact, tap the contact, and then tap **Menu** → **Delete contact**.

Downloads

You can use the **Downloads** application to view and manage downloaded files.

To open the **Downloads**, tap **Apps** → **Downloads**.

Email

You can use the **Email** application to read and send emails. **Email** includes a wizard that makes it easy to configure it for several popular email service providers.

To open the **Email**, tap **Apps** → **Email**.

After add an email account, Email will open to the last screen you were viewing. If you have not used Email recently, it will display the contents of your Inbox (if you have only one account) or the Accounts screen (if you have multiple accounts).

If you have configured Email to send and receive emails from more than one account, you can view all emails sent to all accounts in your Combined Inbox.

Read an email

You can read emails in the Inbox or other folders for individual accounts.

1. Open the combined Inbox, an account's Inbox or another folder of emails.
2. Tap the email to read. The email opens in a screen with information about who sent it, the date it was sent and related information on the top, followed by the contents of the email.

Send an email

You can send an email to your contacts or to other people.

To send an email:

1. Tap (✉) and enter the recipient, subject and message.
2. Tap (📎) to add attachments.

When you enter text in the **To:** field, your tablet shows possible matches from your **Contacts** list, if any exist.

Respond to an email

You can reply to or forward an email that you've received. You can also delete emails and manage them in other ways.

While reading an email, tap **Menu** (☰) and then tap **Reply**, **Reply all**, **Forward** or **Delete**.

Manage email accounts

The Email application enables you to add email accounts from popular web-based email service providers. You can also delete an email account or edit an email account settings.

- To add an email account:

Tap **Menu** → **Account settings** → **Add account**.

- To delete an email account:

1. Tap **Menu** → **Account settings**.
2. Tap the account you want to delete. On the **options** menu, tap **Remove account** and then tap **OK**.

- To edit an email account settings:

Tap **Menu** → **Account settings**.

You can make any changes to general, notification or server settings from this screen.

Gallery

You can use **Gallery** to view pictures and play videos that you've taken with the Camera, downloaded or copied onto your tablet.

Open Gallery

To open Gallery to view your pictures and videos, tap **Apps** → **Gallery**.

Gallery presents the pictures and videos on your tablet, including those you've taken with Camera and those you downloaded from the web or other locations.



- *If you have a great many pictures or videos on your tablet, it may take Gallery a few minutes when you open it to discover and organize them.*
- *Gallery will display all images and videos without distinction of internal or external storage.*

View and browse pictures/videos

All the albums are displayed in the screen.



1. Tap an album to open it and view its contents.
The pictures and videos in the album are displayed in chronological order. You can view the pictures and videos in your albums in stacks, sorted **By album, time, location** and **tags**.
2. Tap **Images and videos** choosing to view **Images only, Videos only**, or both.
3. Tap a picture or video in an album to view it.
You can pinch the picture by two fingers to zoom in or zoom out. Slide left or right to view other pictures/videos.
You can also return to the main Gallery screen at any time by tapping its icon () on the top left of the screen.

Take pictures/videos

You can also tap the camera icon on the top right corner of the screen to take pictures or videos directly. Please refer to the [Camera](#) section for more information.

Work with pictures/videos

After opening a picture or a video, you can work with it as follows:

1. Start a slideshow: Tap .
2. Share photo: Tap to send the photo in a message, transfer it using Bluetooth, email, or post it online.
3. Delete photo: Tap .
4. Tap Menu to see details, rotate, crop, or set as a contact photo or wallpaper.

TOSHIBA Media Player

TOSHIBA Media Player is a multimedia player where users can experience outstanding multimedia enjoyment.

The TOSHIBA Media Player supports a number of multimedia content formats as follows:

Video	H.264, MPEG-4, H.263
Audio	MP3, AAC-LC, HE-AAC, AMR, MIDI, WAVE
Photo	JPEG, GIF, PNG, BMP



TOSHIBA does not guarantee that all the audio/video files with the above code will be played correctly.

The main screen of this player contains two parts: one is the Mode Icons, the other is the Main Menu area. This player contains the following modes: **Audio**, **Video**, **Photo**, **DMP** and **Podcast**. You can switch mode by selecting the mode icon. The content of the Main Menu area will be changed automatically with current mode. In the main window, tap **Menu** to open the following options:

- **About**
Show version information, etc.
- **Capture Photo**
Start the Camera application in photo mode.
- **Capture Video**
Start the Camera application in movie mode.
- **Help**
Show help information.



- *Do not eject (or unmount) external media during contents search as this will cause music playback to stop.*
- *DMP (Digital Media Player) function supports to connect Windows media player 12 on Windows® 7 only.*
- *Some "double-byte" characters might not be displayed correctly. This is the Operating System limitation.*

For detailed information, please refer to the TOSHIBA Media Player Help file.

Music

You can use **Music** to organize and listen to music and other audio files that are in your tablet, SD card or USB storage.

Music supports a wide variety of audio files formats so it can play music that you purchase from online stores, or you copy from your CD collection and so on. For the details of supported formats, please refer to [TOSHIBA Media Player](#) in this chapter.

To open the Music screen, tap **Apps** → **Music**.

The Music library screen will open with tabs that you can tap to view your music library organized by **New and recent**, **Albums**, **Artists**, **Songs**, **Playlists** or **Genres**.

Play Music

You can listen to music by using your tablet's built-in speakers.

To play music:

- Tap a song in your library to listen to it.

Work with playlists

You can create playlists to organize your music files into sets of songs, which you can play in the order you set or in a shuffle.

To create a playlist:

1. Tap sort tab on the Music library screen and choose **Playlists** tab.
2. Tap plus icon to add a new playlist.
3. Enter a name and tap **OK** to save.

The new playlist is added to the Playlist library.

You can add other songs that are playing in the **Now playing** screen in a playlist by tapping **Menu** and tapping **Add to playlist**.

Choose an existing playlist, or tap **New playlist** to create a new playlist.

To edit, delete, and rename a playlist, tap and hold the playlist.

Picture frame

Picture frame is a widget to display the pictures or photos on the screen as if in a container. This makes it easier for users to enjoy the pictures. You can select pictures directly.

Service Station

The Service Station utility is used to provide you with updates for both application and system software. It will notify you when new versions of your software are available, as well as download and install them.

To open Service Station:

Tap **Apps** → **Service Station**.

Window

When you run the Service Station for the first time, you are prompted to accept the access agreement. The agreement authorizes the utility to collect certain basic information about your tablet and send it to the TOSHIBA servers as part of the process of obtaining updates. Accept or Decline the agreement by tapping the buttons. While it is possible to decline the agreement, it is not recommended, as this means the Service Station utility will not run, and you will not be notified of new software updates for your tablet.

Main Window

The main window of this application includes three areas: **Header**, **Buttons**, and **Information**.

■ Header

This section runs along the top of the screen, and contains basic information about your system such as the version of the operating system, the tablet part number and serial number.

■ Buttons

Buttons are displayed on the screen. These buttons will change, depending on what actions you have available on the current screen.

■ Information

The main part of the screen displays information such as the list of available updates, or more detailed information about a specific update.

Check for Updates

During normal operations, the Service Station will periodically check to see if there are any updates for your system. This is done automatically. If there are new updates available, you will be notified with the Service Station icon in the status bar of your tablet.

While the Service Station will periodically check for updates in the background, you can request that it check for updates immediately. Tap the **Check for Updates** button, and the application will refresh the list of available updates.





- *It is not normally necessary to check for updates manually, as the utility checks for them automatically and informs you when one is available.*
- *Please connect the AC adaptor before updating.*

Downloading Updates

When an update is available, it will appear on the information area of the screen. Tap the item displayed. More details for that item are displayed on the screen.

To download the update, tap the **Download** button. This will begin the download process. A progress indicator is displayed.



- *Tapping **Home** () allows the download to continue while you use your tablet. A notification of the download completion will appear in the system status bar.*
- *Tapping **Back** () will abort the download process.*

Installing Updates

Once an update has been downloaded, it can be installed. If you are not on the display showing the information for that item, go to the screen by launching the Service Station utility, or by tapping the download completion notice on the system status bar.

Tap the **Install** button. This will launch the application installer. Continue with installation.

Downloading and Installing System Updates

Service Station will download both application and system updates. System updates require that your tablet is rebooted during the update.

Downloading a system update is the same as an application update.

Installing a system update is similar to an application update, but you will be reminded that the tablet will be rebooted during the installation process. Make sure to close any other applications and save all work prior to installing a system update.



It is important that a system update is not interrupted once it has begun. Make sure the AC power is plugged in before beginning the installation and don't turn the tablet off while the installation is in progress.

Note that the system may reboot more than once during an system update, depending on the update itself.



This application only updates system area in the internal storage. User data area is kept after the system is updated.

TOSHIBA File Manager

You can use this file manager for managing files and folders in your storage. You can create folders, rename, move, copy or delete files or folders in the tablet's storage, SD card and USB storage.

To open TOSHIBA File Manager:

Tap **Apps** → **File Manager**.



- *TOSHIBA File Manager will only show files and folders in the storage area. System files are not shown and cannot be accessed.*
- *TOSHIBA File Manager may not be able to open a file if there is no associated application for this file.*

File Browsing Window

The window of this application includes four areas: **Device**, **Path**, **File** and **Control**.

■ Device

Internal storage, SD card and USB storage will be shown. You can tap any device icon to open its content.

■ Path

The device's name is shown on the left side and the relative path on the right side.

- **File**
Folders and files are listed in multi-columns with thumbnails which show the file information such as Name, Modified date time, etc. The selected files or folders would be tagged as red.
- **Control**
You can select files, create folders and go up to the upper level directory by selecting different options.

Files & Folders Operation

After you tap **Select File**, a file selecting window will be opened which enables you to multi-select, copy, cut and delete selected files or folders. There are six options: **Select All**, **Deselect All**, **Cancel**, **Cut**, **Copy** and **Delete**.

- **Select All**
Tap to select all the folders and files in the current path.
- **Deselect All**
Tap to deselect all the folders and files in the current path.
- **Cancel**
Tap to cancel file operation and return to file browsing window.
- **Cut**
Tap to cut the selected files or folders and paste them to the target path. After choosing the right path, tap **Paste** to move files or folders into the target directory.
- **Copy**
Tap to copy the selected files or folders to the target path. After choosing the right path, tap **Paste** to copy files or folders into the target directory.
- **Delete**
Tap to delete the selected files. A dialog is shown asking you to confirm deletion. Tap **OK** or **Cancel** to continue.

By tapping and holding on a file or folder icon, a pop-up menu will be displayed which enables you to **Cut**, **Copy**, **Delete** or **Rename** the selected file or folder.

Rename Files or Folders

You can rename a file or folder by using the following steps:

1. Tap and hold the selected file or folder.
2. Tap **Rename** from the menu to input a new name for the selected file or folder.
3. Tap **OK**.



Create Folders

You can also create a new folder by using the following steps:

1. Choose the right directory in the file browsing window, and tap **Create a folder**.
2. In the dialog shown, input a new folder name and tap **OK** to continue.

Storage Structure

The following table describes the meaning of the device icons in TOSHIBA File Manager.

Icon	Name	Description
	Internal Storage	It shows all the contents in the tablet's flash memory except the system files and files in SD card and USB storage.
	SD card	It shows all the contents in the SD card.
	USB storage	It shows a menu of connected USB devices (totally support of a maximum of eight disk partitions).

Online Manual

Online Manual is an application to launch the pre-installed online manual (this manual) for this tablet.

Settings

This chapter will describe different setting options in the **Settings** application.

You can use **Settings** to configure how your tablet sounds, communicates and operates in many other ways.



A scrollbar is displayed in right side of the screen. This scrollbar is only used to show the position of the displayed area. You can scroll the settings items using your fingers or USB mouse.

Wireless & networks

You can use **Wireless & networks** settings to configure and manage connections to networks and devices by using Wi-Fi, Bluetooth and mobile networks. You can also use wireless controls to turn off all radios with Airplane mode. See [Connecting to networks](#) chapter for detailed information.

- **Airplane mode**

Check this option to disable all wireless radios.

- **Wi-Fi**

Check this option to turn on Wi-Fi so you can connect to Wi-Fi networks.

- **Wi-Fi settings**

Tap to set up and manage wireless access points.

- **Bluetooth**

Check this option to turn on Bluetooth so you can connect to Bluetooth devices.

- **Bluetooth settings**

Tap to manage connections, set device name & discoverability.

- **Tethering & portable hotspot settings**

Tap to set up USB/Bluetooth tethering and portable hotspot.



This function is only supported by 3G models.

- **VPN settings**

Tap to set up and manage Virtual Private Networks (VPNs).

■ **Mobile networks**

Tap to set options for roaming, networks and APNs.



This function is only supported by 3G models.

Sound

You can use **Sound** settings to configure many aspects of notification ringtones, music and other audio.

Sound settings contains the following options:

■ **Volume**

Tap to open a dialog where you can drag a slider to set the volume for media, notification and alarm.

■ **Notification ringtone**

Tap to open a dialog where you can set the default notification tone when you receive a notification.

■ **Audible selection**

Check this option to play sound when making screen touch.

■ **Screen lock sounds**

Check this option to play sound when locking and unlocking the screen.

■ **Haptic feedback**

Check this option to vibrate when pressing soft keys and on certain UI interactions.

Screen

You can use **Screen** settings to configure the brightness and other screen settings.

Screen settings contains the following options:

■ **Brightness**

Tap to open a dialog that contains a slider for adjusting the screen brightness.

■ **Auto-rotate screen**

Check this option to lock screen orientation as you turn your tablet sideways.

■ **Animation**

Tap to open a dialog where you can select whether to show animations.

■ **Timeout**

Tap to open a dialog where you can set how long to wait before the screen automatically turns off.

Multimedia

You can use **Multimedia** settings to enhance multimedia effect.

Multimedia settings contains the following options:

- **Video enhancement**

Check this option to enable video enhancer function with Resolution+ and Adaptive Display.

- **Audio enhancement**

Tap to setup and enable audio enhancer function with SRS and Toshiba Technologies.

SRS Premium Voice PRO information

SRS Premium Voice PRO™ provides a superior voice communication and multimedia experience for the PC.



Location & security

You can use **Location & security** settings to configure settings that help secure your tablet and its data.

Location & security contains the following options:

- **Use wireless networks**

Check this option to find your location via wireless networks.

- **Use GPS satellites**

Check this option to find your location via GPS satellites.

- **Configure lock screen**

Tap to open a screen where you can configure the tablet to lock screen with a pattern, PIN or password. You can also choose **Off** to disable screen lock.

- **Owner info**

Tap to open a dialog where you can enter text to display on the lock screen.

- **Encrypt tablet**

Tap to open a dialog where you can set numeric PIN or password to decrypt your tablet each time you power it on.



*A PIN or password must be set (using **Configure lock screen** option) before tapping the "Encrypt tablet" option.*

- **Set up SIM card lock**

Tap to open a screen where you can configure the tablet to require entering the SIM PIN to use the tablet and where you can change the SIM PIN.



This function is only supported by 3G models.

■ **Visible passwords**

Check this option to briefly show each password character as you enter them, so that you can see what you enter.

■ **Device administrators**

Tap to open a screen where you can add or remove device administrators.

■ **Use secure credentials**

Check this option to allow applications to access your tablet's encrypted store of secure certificates and related passwords and other credentials. You can use credential storage to establish some kinds of Wi-Fi connections. If you have not set a password for credential storage, this setting is dimmed.

■ **Install from storage**

Tap to install a secure certificate from the storage.

■ **Set password**

Tap to open a dialog where you can set or change the password for your secure credential storage. Your password must have at least 8 characters.

■ **Clear credentials**

Tap to delete all secure certificates and related credentials and erases the secure storage's own password, after prompting you to confirm that you want to do this.

Applications

You can use the **Applications** settings to view details about the applications installed on your tablet, to manage their data and force them to stop, and to set whether you want to permit installation of non-Market applications that you obtain from web sites and email.

■ **Manage applications**

Tap to open a list of downloaded applications and other software installed on your tablet, along with their size. These are sorted in alphabetical order.

■ **Running services**

Tap to open a list of services - applications or parts of applications that provide services to other applications or that run even when their main application isn't running. Above each service, one or more gray bars show which processes the running service needs and how much memory it's using. Depending on the service, when you tap it in the list it will either open a dialog in which you can stop it or open its Settings screen.

■ **Storage use**

Tap to open a list of all applications and software installed on your tablet, along with their size.

- **Battery use**
Tap to open a screen of battery usage data.
- **Unknown sources**
Check this option to permit installation of applications that you obtain from websites, email or other locations.
- **Development**
This option contains settings that are useful for developing applications.



- *This tablet does not support another Operating System.*
- *TOSHIBA cannot guarantee or support applications that are installed by a user.*

Accounts & sync

You can manage your mail or exchange accounts by using **Accounts & sync** settings.

- **Add account**
Tap **Add account** tab on the top right corner to add a mail account or an exchange account. You can sync your contacts, calendar or other applications data via an exchange account.
- **Background data**
Check this option to enable applications to sync, send, and receive data at any time.
- **Auto-sync**
Check this option to sync applications data automatically.
- **Manage accounts**
You can tap to edit an account. Settings vary with different account type.

Privacy

You can use the **Privacy** settings to manage your personal information.

- **Back up my data**
Check this option to back up application data, Wi-Fi passwords, and other settings to Google servers.
- **Backup account**
Tap to display the Google Account that your settings and other data are backed up with.
- **Automatic restore**
Check this option to restore backup settings or other data when you reinstall an application.
- **Factory data reset**
Tap to erase all user data in the internal storage. Follow the on-screen instructions to reset it. Please note that data in the removable media won't be erased. See [Factory Reset](#) section in "Basic Operations & Home screen" chapter for details.

Storage

Storage settings show your internal storage and external storage status.

External storage

External storage may contain the following options depending on the devices that you inserted:

- **If only an SD card is inserted**
 - **Unmount SD card**
Tap to unmount the SD card for safe removal.
- **If a USB memory device and an SD card are inserted**
 - **Unmount SD card**
Tap to unmount the SD card for safe removal.
 - **Unmount USB0 - Unmount USB7**
Tap to unmount the USB memory device for safe removal.

Internal storage

Internal storage contains the following options:

- **Total**
Shows the total space amount of internal storage in your tablet.
- **Available**
Shows the free space of internal storage.
- **Media**
The amount of media data of internal storage.
- **Applications**
The amount of application data of internal storage.

Language & input

You can use **Language & input** settings to select the language for the text, voice input and voice output on your tablet and for configuring the onscreen keyboard, including words that you've added to its dictionary.

- **Select language**
Tap to select the language for the text on your tablet from a list.
- **User dictionary**
Tap to add words in user dictionary.
- **Text-to-speech settings**
Tap to open a dialog where you can set the voice data required for text-to-speech function.
- **Keyboard settings**
Configure the onscreen keyboard.

Accessibility

You can use **Accessibility** settings to enable accessibility functions, such as text-to-speech or enlarge text on screen.

You should download accessibility scripts from Google first.

Date & time

You can use **Date & time** settings to set your preferences for how dates are displayed. You can also use these settings to set your own time and time zone, rather than obtaining the current time from the mobile network.

- **Automatic date & time**

Uncheck this option to set the date, time and time zone on the tablet manually rather than obtaining the current time from the network.

- **Automatic time zone**

Uncheck this option to set the time zone on your tablet manually rather than obtaining the local time zone from the network.



This function is only supported by 3G models.

- **Set date**

If **Automatic date & time** is unchecked, tapping it will open a dialog where you can manually set the tablet's date.



The system date cannot be set beyond Jan/18/2038.

- **Set time**

If **Automatic date & time** is unchecked, tapping it will open a dialog where you can manually set the tablet's time.

- **Select time zone**

If **Automatic time zone** is unchecked, tapping it will open a dialog where you can set the tablet's time zone.

- **Use 24-hour format**

Check this option to display the time using 24-hour time format - for example, 13:00 rather than 1:00 pm.

- **Select date format**

Tap to open a dialog where you can select the format for displaying dates.

About tablet

About tablet includes information about your tablet.

- **System update**

Tap to open the screen to check your system for update.

- **Status**

Tap to open the Status screen with a long list of information about your battery, mobile network connection and other details.

- **System information**

Tap to open a screen that displays some basic information of your tablet, such as Manufacture, Product name, Product version and Serial number, etc.

- **Battery use**

Tap to open a list of the applications and operating system components you have used since you last connected the tablet to a power source, sorted by the amount of power they have used.

- **Legal information**

Tap to open a screen where you can obtain legal information about the softwares included with your tablet.

- **Model number**

Display the model number of your tablet.

- **Android version**

Display the current Android version installed in your tablet.

- **Baseband version**

Display the baseband version.



This function is only supported by 3G models.

- **Kernel version**

Display the kernel version.

- **Build number**

Display the build number.

Hardware & Options Operation

This chapter identifies the various components and the hardware of the tablet - it is recommended that you become familiar with each before you operate the tablet.



- *Please handle your tablet carefully to avoid scratching or damaging the surface.*
- *This tablet does not support CD/DVD/Blu-ray Disc™.*
- *This tablet cannot be used as a mobile phone.*
- *Content that is copyright protected or has limited access rights, cannot be played on this tablet.*

Hardware

This section describes the hardware of your tablet.

The actual specifications may vary depending on the model you purchased.

Processor

CPU	Your tablet is equipped with an nVIDIA® Tegra™ Mobile Processor.
------------	--

Memory

Memory on board	This tablet is equipped with a 1GB memory on board. The actual amount of usable system memory will be less than the installed memory modules. This tablet does not support memory expansion.
------------------------	--

Flash Memory	This tablet is equipped with a flash memory.
---------------------	--

Power

Battery pack	The tablet is powered by one replaceable lithium-ion battery pack.
AC adaptor	<p>The AC adaptor provides power to the system and recharges the batteries when they are low. It comes with a detachable power cord which will either have a 2-pin or 3-pin plug enclosure.</p> <p>As the AC adaptor is universal, it can receive a range of AC voltages from 100 to 240 volts, however you should note that the output current varies among different models. Using the wrong adaptor might damage your tablet.</p>

Display

The tablet's internal display panel supports high-resolution video graphics and can be set to a wide range of viewing angles for maximum comfort and readability.

Display panel	<p>25.7cm (10.1") LCD screen, configured with the following resolution:</p> <ul style="list-style-type: none"> ■ 1280 horizontal x 800 vertical pixels
Graphics controller	The graphics controller maximizes display performance.

Multimedia

Web Camera	Web Camera is a device that allows you to record video or take photographs with your tablet. You can use it for video chatting or video conferences by using a communication tool.
-------------------	--

Communications

Bluetooth	Some models have Bluetooth wireless communication function which eliminates the need for cables between electronic devices such as computers, printers and mobile phones. When it is enabled, Bluetooth will provide the wireless personal area network environment which is safe and trustworthy, that is quick and easy.
Wireless LAN	The tablet is equipped with a Wireless LAN module that is compatible with other Wireless LAN systems based on Direct Sequence Spread Spectrum/Orthogonal Frequency Division Multiplexing radio technology that complies with the IEEE 802.11 Standard.

3G

Some models are equipped with a 3G module.



FCC compliance and Industry Canada (IC) compliance does not apply to this product with a 3G module installed.

CAUTION

Bluetooth™ and Wireless LAN devices operate within the same radio frequency range and may interfere with one another. If you use Bluetooth™ and Wireless LAN devices simultaneously, you may occasionally experience a less than optimal network performance or even lose your network connection.

If you experience any such problem, immediately turn off either of your Bluetooth™ or Wireless LAN.

Please visit the following website:

In Europe visit <http://www.toshiba-europe.com/computers/tnt/bluetooth.htm>

In the United States visit <http://www.pc.support.global.toshiba.com>

Battery pack

This section explains battery pack use, recharging methods and handling.

When the AC adaptor is not connected, the tablet's main power source is a removable lithium ion battery pack. You can purchase additional battery packs for extended use of the tablet away from an AC power source although you should not change the battery pack while the AC adaptor is connected.

Before you remove the battery pack, save your data and shut down the tablet.

Care and use of the battery pack

This section provides the important safety precautions in order to handle your battery pack properly.

Refer to the enclosed ***Instruction Manual for Safety and Comfort*** for detailed precautions and handling instructions.



- *Make sure the battery is securely installed in the tablet before attempting to charge the battery pack. Improper installation could generate smoke or fire, or cause the battery pack to rupture.*
- *Keep the battery pack out of reach of infants and children. It can cause injury.*



- *The lithium ion battery pack can explode if not replaced, used, handled or disposed of properly. Dispose of the battery as required by local ordinances or regulations. Use only batteries recommended by TOSHIBA as replacements.*
- *The tablet's RTC battery is a lithium battery and should be replaced only by your dealer or by a TOSHIBA service representative. The battery can explode if not properly replaced, used, handled or disposed. Dispose of the battery as required by local ordinances or regulations.*
- *Charge the battery pack only in an ambient temperature between 5 and 35 degrees Celsius. Otherwise, the electrolyte solution might leak, battery pack performance might deteriorate and the battery life might be shortened.*
- *Never install or remove the battery pack without first turning off the power and disconnecting the AC adaptor. Never remove the battery pack while the tablet is in Suspend Mode. Data could be lost.*

Charging the batteries

When the power in the battery pack becomes low, the **Battery** indicator will blink amber to indicate that only a few minutes of battery power remain.

You must recharge a battery pack when it becomes discharged.

Procedures

To recharge a battery pack while it is installed in the tablet, connect the AC adaptor to the DC IN 19V jack and plug the other end into a working outlet.



Use only the tablet connected to an AC power source or TOSHIBA Tablet Dock to charge the battery pack. Never attempt to charge the battery pack with any other charger.

Battery charging notice

The battery may not begin charging immediately under the following conditions:

- The battery is extremely hot or cold (if the battery is extremely hot, it might not charge at all). To ensure the battery charges to its full capacity, you should charge it at room temperature of between 5°C to 35°C (41°F to 95°F).
- The battery is nearly completely discharged. In this instance you should leave the AC adaptor connected for a few minutes and the battery should begin charging.

The **Battery** indicator may show a rapid decrease in battery operating time when you try to charge a battery under the following conditions:

- The battery has not been used for a long time.
- The battery has completely discharged and been left in the tablet for a long time.
- A cool battery is installed in a warm tablet.

In such cases you should follow the steps as detailed below:

1. Fully discharge the battery by leaving it in the tablet with the power on until the system automatically turns itself off.
2. Connect the AC adaptor to the DC IN 19V jack of the tablet, and to a wall outlet that is supplying power.
3. Charge the battery until the **Battery** indicator glows white.

Repeat these steps two or three times until the battery recovers normal capacity.

Charging time

The following table shows the approximate time required to fully charge a discharged battery.

Charging time (hours)

Battery type	Power on	Power off
Battery pack (23Wh, 6 cell)	about 2	about 2



Please be aware that the charging time when the tablet is on is affected by ambient temperature, the temperature of the tablet and how you are using the tablet - if you make heavy use of external devices for example, the battery might scarcely charge at all during operation.

Battery life

The following table shows the approximate battery life of a fully charged battery.

Battery life

Battery type	Time
Battery pack (23Wh, 6 cell)	about 7 ~ 20 hours (in use) about 5.5 days (Suspend Mode)



Please be aware that the battery life will be affected by how you are using the tablet.

Replacing the Battery Pack

Please be aware that the battery pack is classified as a consumable item. The operating life of the battery pack will gradually reduce through repeated charging and discharging, and will need to be replaced when it reaches the end of its operating life. In addition to this, you might also replace a discharged battery pack with a charged spare when you are operating your tablet away from an AC power source for an extended period of time.

This section explains how to remove and install the battery pack, and begins with the removal process which is detailed through the following steps.

Removing the battery pack

To remove a discharged battery, follow the steps as detailed below:

1. Save your work.
2. Turn the tablet's power off.
3. Remove all cables and peripherals that are connected to the tablet. Remove the memory cards from the memory card slot.
4. Turn the tablet upside down.
5. Slide the cover lock into its unlock (🔓) position.
6. Slide your finger under the cover recess nearby the cover lock and lift this corner up first.

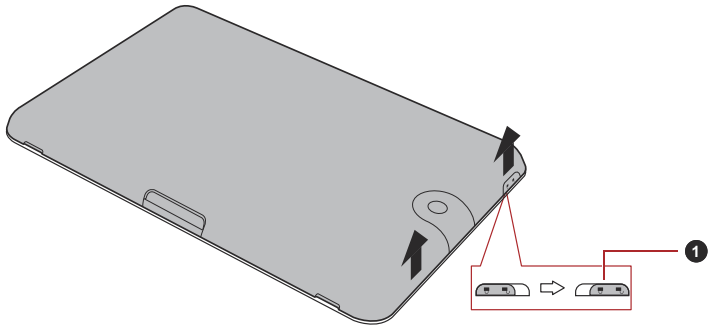

1. Cover lock

(Sample Illustration) Removing the cover-1

7. Lift the cover up according to the following figure and then remove the cover.

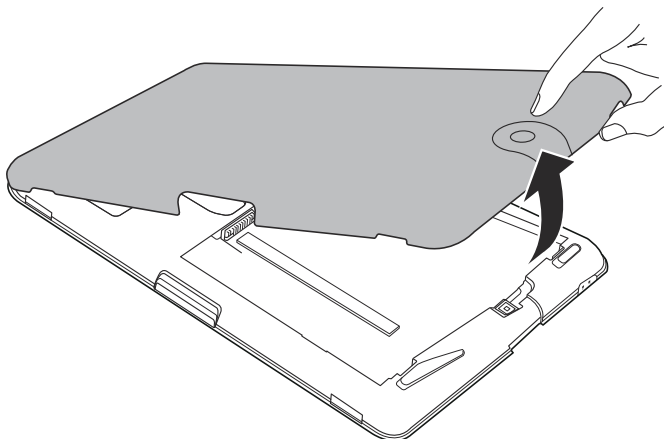

(Sample Illustration) Removing the cover-2

8. Slide the battery lock into its unlocked (🔓) position.
9. Slide and hold the battery release latch to disengage the battery pack and then lift it up to remove it from the tablet.

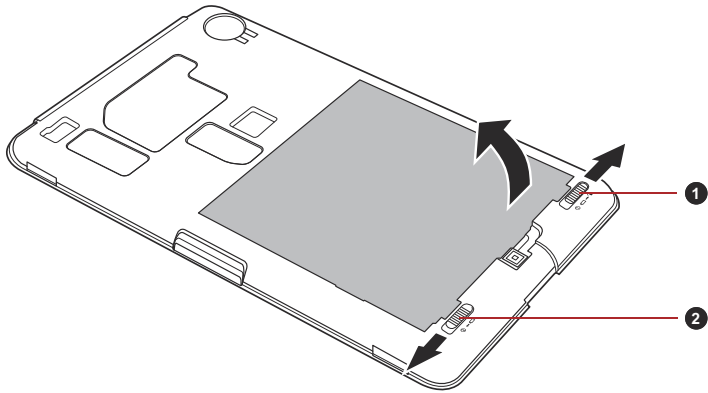

1. Battery lock

2. Battery release latch

(Sample Illustration) Removing the battery pack

Installing the battery pack

To install a battery pack, follow the steps as detailed below:

1. Align the connectors of the battery pack with that of the tablet and gently insert the battery pack into the tablet at about a 30 degree angle.

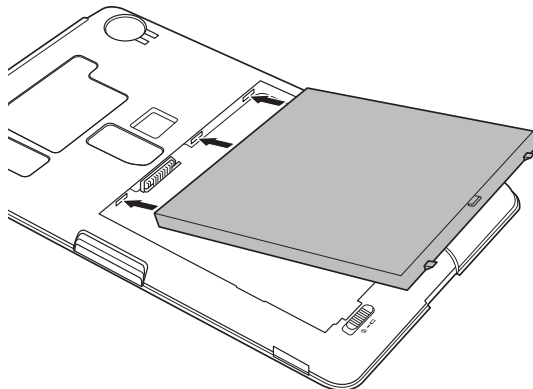

(Sample Illustration) Installing the battery pack

2. Ensure that the battery pack is securely in place and the battery lock is in its lock (🔒) position.
3. Seat the cover in place and slide the cover lock to its lock (🔒) position.

Mini USB port

This tablet is equipped with a mini USB port that enables you to connect to a computer.

To connect to a computer:

1. Plug the Mini USB connector of a USB cable into the Mini USB port on this tablet.
2. Plug the other end of the USB cable into the USB port on the computer.

Then this tablet becomes a removable MTP (Media Transfer Protocol) device and you can access its content from the computer.

To remove this tablet from the computer:

1. Make sure all file operations are finished.
2. Click the Safely Remove Hardware and Eject Media icon on the Windows Taskbar.
3. Click **Eject MTP**.



- *Make sure the connector is properly aligned with the socket. Do not try to force the connection, doing so can damage the connecting pins.*
- *Mini USB port only supports slave mode.*

Optional devices

Optional devices can expand your tablet's capabilities and its versatility. This section describes the connection or installation of the following devices:

Cards

- Memory media slot
 - Secure Digital™ (SD) Card (SD memory card, SDHC memory card, SDXC memory card, miniSD Card, microSD Card)
 - MultiMediaCard
- SIM card slot

Peripheral devices

- USB device
- HDMI device
- TOSHIBA Tablet USB Cradle
- TOSHIBA Tablet Cradle

Memory media slot

The tablet is equipped with an memory media slot that can accommodate some kinds of memory media with various memory capacities so that you can easily transfer data from devices, such as digital cameras and Personal Digital Assistants.



- This memory media slot supports the following memory media.
 - Secure Digital (SD) Card (SD memory card, SDHC memory card, SDXC memory card, miniSD Card, microSD Card)
 - MultiMediaCard
- Please note that an adaptor is required to use miniSD/microSD Card.
- Please note that not all memory media have been tested and verified to work correctly. Therefore, it is not possible to guarantee that all memory media will operate properly.
- Please note that Ultra High Speed (UHS-I) function is not supported.
- The slot does not support Magic Gate functions.

Memory media

This section provides the important safety precautions in order to handle your memory media.



Points to note about the SD/SDHC/SDXC memory card

SD/SDHC/SDXC memory cards comply with SDMI (Secure Digital Music Initiative), which is a technology adopted to prevent unlawful copy or playback of digital music. For this reason, you cannot copy or playback protected material on another tablet or other device, and you may not reproduce any copyrighted material except for your personal enjoyment.

Below is a simple explanation for distinguishing SD memory cards from SDHC and SDXC memory cards.

- SD, SDHC and SDXC memory cards appear the same externally. However, the logo on SD, SDHC and SDXC memory cards is different, so pay careful attention to the logo when purchasing.



- The SD memory card logo is .
 - The SDHC memory card logo is .
 - The SDXC memory card logo is .
- The maximum capacity of SD memory cards is 2GB. The maximum capacity of SDHC memory cards is 32GB. The maximum capacity of SDXC memory cards is 64GB.

Card Type	Capacities
SD	8MB, 16MB, 32MB, 64MB, 128MB, 256MB, 512MB, 1GB, 2GB
SDHC	4GB, 8GB, 16GB, 32GB
SDXC	64GB

Memory media format

New media cards are formatted according to specific standards. If you wish to reformat a media card, be sure to do so with a device that uses media cards.

Formatting an SD/SDHC/SDXC memory card

SD/SDHC/SDXC memory cards are sold already formatted in conformity to specific standards. If you reformat an SD/SDHC/SDXC memory card, be sure to reformat it with a device such as digital camera or digital audio player that uses the SD/SDHC/SDXC memory cards, not with the format command provided within Windows.



If you need to format all areas of the memory card, including the protected area, you will need to obtain an appropriate application that applies the copy protection system.

Media care

Observe the following precautions when handling the card.

Card care

- Do not twist or bend cards.
- Do not expose cards to liquids or store in humid areas or lay media close to containers of liquid.
- Do not touch the metal part of a card or expose it to liquids or let it get dirty.
- After using card, return it to its case.
- The card is designed so that it can be inserted only one way. Do not try to force the card into the slot.
- Do not leave a card partially inserted in the slot. Press the card until you hear it click into place.

Memory card care

- Set the write-protect switch to the lock position, if you do not want to record data.
- Memory cards have a limited lifespan, so it is important to backup important data.
- Do not write to a card if the battery power is low. Low power could affect writing accuracy.
- Do not remove a card while read/write is in progress.



For more details on using memory cards, see manuals accompanying the cards.

About the write-protect

The following memory media have a function for protect.

- SD Card (SD memory card, SDHC memory card, SDXC memory card)



Set the write-protect switch to the lock position, if you do not want to record data.

Inserting a memory media

The following instructions apply to all types of supported media devices. To insert a memory media, follow the steps as detailed below:

1. Turn the memory media so that the contacts (metal areas) are facing down.
2. Insert the memory media into the memory media slot on the tablet.
3. Push the memory media gently to ensure a firm connection is made.

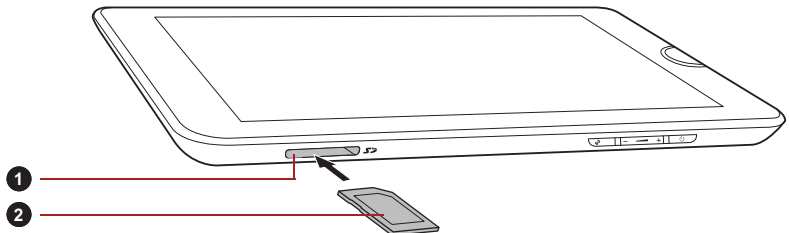

1. Memory media slot

2. Memory media

(Sample Illustration) Inserting a memory media



- *Make sure memory media is oriented properly before you insert it. If you insert the media in wrong direction, you may not be able to remove it.*
- *When inserting memory media, do not touch the metal contacts. You could expose the storage area to static electricity, which can destroy data.*
- *Do not turn the tablet off or switch to Suspend Mode while files are being copied - doing so may cause data to be lost.*

Removing a memory media

The following instructions apply to all types of supported media devices. To remove a memory media, follow the steps as detailed below:

1. Make sure all file operations are finished.
2. Tap **Apps** → **Settings** → **Storage** → **Unmount SD card**.
3. Press the memory media until you hear a click.
4. Release the memory media to partially extend it out of the tablet.
5. Grasp it and pull it out of the slot.



- Do not remove the memory media while the tablet is in Suspend mode. The tablet could become unstable or data in the memory media could be lost.
- Do not remove only the miniSD/microSD Card while leaving the adaptor in the memory media slot.

SIM card slot

Some models are equipped with a SIM card slot that allows you to assemble a SIM card from your wireless service provider to use your provider's mobile networks for transmitting data.



This section only applies to models with 3G modules.

Inserting a SIM card

To insert a SIM card, follow the steps as detailed below:

1. Turn off your tablet. Remove the cover and the battery pack as described in the [Removing the battery pack](#) section.
2. Locate the SIM card slot beside the battery pack slot.
3. Slide your SIM card into the SIM card slot with your finger as shown on the figure below.

You can slide the SIM card with your finger in the opposite direction to remove the SIM card.

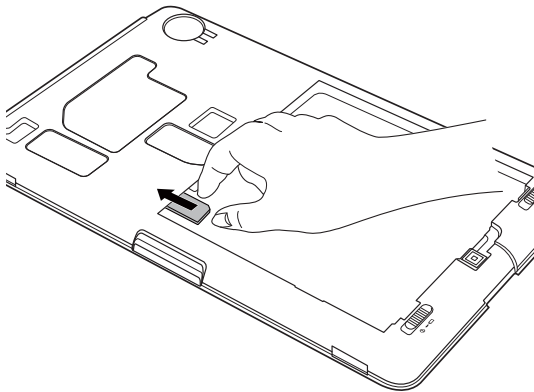

(Sample Illustration) Inserting a SIM card

4. Install the battery pack and the cover in place. Now you can power on your tablet to use your provider's mobile networks.

USB device

This tablet is equipped with a USB port that can accommodate the following USB devices: USB flash memory, External USB HDD, HID (Keyboard and Mouse) and USB hub. This port complies with USB 2.0 standard.

To connect a USB device, plug the device's connector into the USB port on your tablet.



Make sure the connector is properly aligned with the socket. Do not try to force the connection, doing so can damage the connecting pins.



As the port operation of all USB devices has not been confirmed, some USB devices may not function properly.

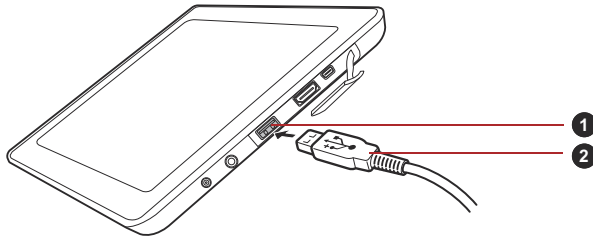

1. USB port

2. USB connector

(Sample Illustration) Connecting a USB device



- *This tablet does not support a printer connected to the USB port.*
- *This tablet only support external USB HDD (FAT only) and USB Flash Memory (FAT only) for data copy.*
- *Though USB hubs, USB flash memory and USB HDDs are also supported, the proper function and behavior of all such devices is not guaranteed.*
- *If the USB device you connected is not supported by this tablet, a notification will be shown.*
- *This tablet supports FAT12/16/32/exFAT format for USB memory and USB hard drives.*

HDMI device

The tablet is equipped with an HDMI port that can send video by connecting with external devices. 720p, 576p and 480p signal formats are supported, but actually available signal format depends on each HDMI device.

To connect external devices, follow the steps as detailed below:



As the port operation of all HDMI (High-Definition Multimedia Interface) monitors has not been confirmed, some HDMI monitors may not function properly.

1. Plug one end of the HDMI cable into the HDMI port of the HDMI device.
2. Plug the other end of the HDMI cable into the HDMI port on your tablet.

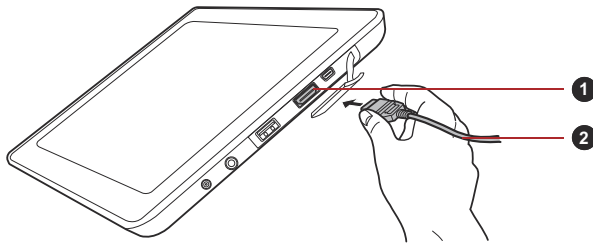

1. HDMI port

2. HDMI cable

(Sample Illustration) Connecting an HDMI cable

Please connect or disconnect an HDMI device to or from the tablet under the following conditions:

- *The tablet is turned on.*
- *The tablet is completely turned off.*

Do not do so when the tablet is in Sleep Mode or Hibernation Mode.



- *When you connect a television or external monitor to the HDMI port, the display output device is set to HDMI.*
- *When you unplug the HDMI cable and re-plug it, please wait at least 5 seconds before you re-plug the HDMI cable again.*

TOSHIBA Tablet Dock

Your tablet can accommodate some kinds of docks providing extra ports, so that you can charge the battery.

Dock Type	Feature
TOSHIBA Tablet USB Cradle	<ul style="list-style-type: none"> ■ Power supply and battery charge ■ Extra ports
TOSHIBA Tablet Cradle	<ul style="list-style-type: none"> ■ Power supply and battery charge

Using the TOSHIBA Tablet Dock

Connecting the AC adaptor

1. Connect the power cord to the AC adaptor.

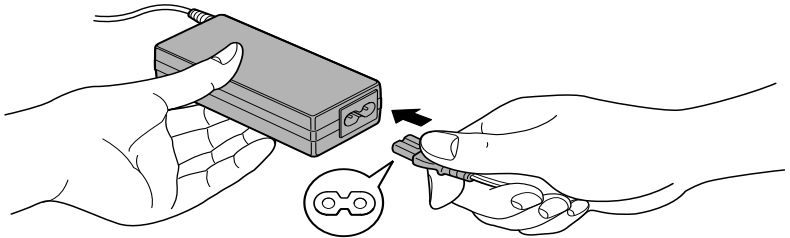

(Sample Illustration) Connecting the power cord to the AC adaptor (2-pin plug)

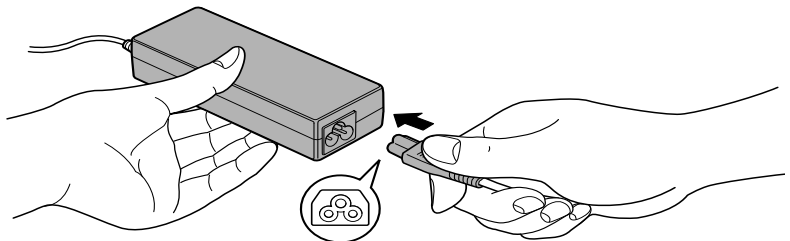

(Sample Illustration) Connecting the power cord to the AC adaptor (3-pin plug)



Either a 2-pin or 3-pin adaptor/cord will be included with the tablet depending on the model.

2. Connect the AC Adaptor (provided with your TOSHIBA tablet or purchasing separately) to the Dock.
3. Plug the power cord into a live wall outlet.

Connecting the TOSHIBA Tablet USB Cradle / TOSHIBA Tablet Cradle



You must connect the AC adaptor before you connect to the dock.

When the dock is connected to your tablet, you can not use the following ports on your tablet: DC IN 19V jack and HDMI port.

1. Turn on your TOSHIBA Tablet.
2. Align the docking mark on your tablet with that on the dock.

3. Connect the docking interface on your tablet with the docking connector on the dock.

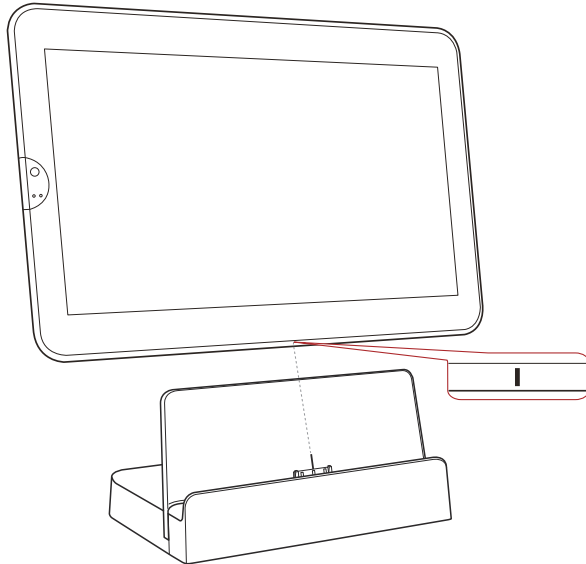

(Sample Illustration) Connecting your tablet with the dock

A notice of connecting will appear on the status bar of your tablet.
To disconnect your tablet, remove your tablet following the connector's direction.

The Grand Tour of the dock

The following figures show the ports on the dock.

TOSHIBA Tablet USB Cradle

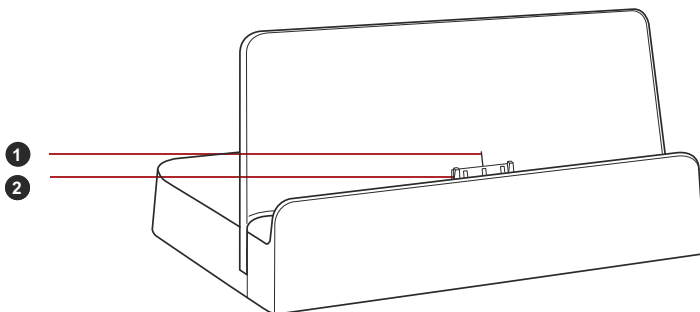

1. Docking mark

2. Docking connector

(Sample Illustration) Front of the dock

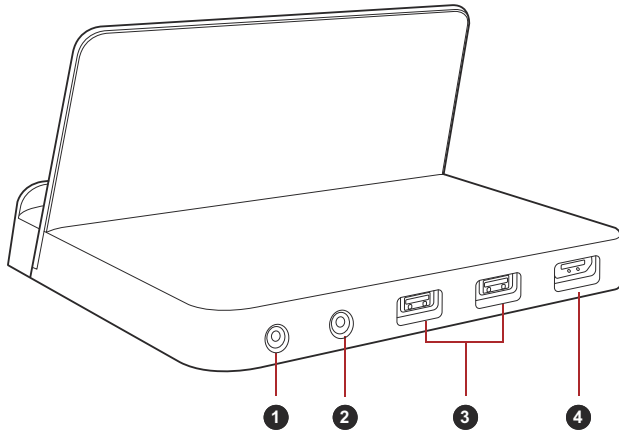

- 1. DC IN 19V jack
 - 2. Headphone jack
 - 3. Universal Serial Bus 2.0 ports
 - 4. HDMI port
- (Sample Illustration) Back of the dock*

TOSHIBA Tablet Cradle

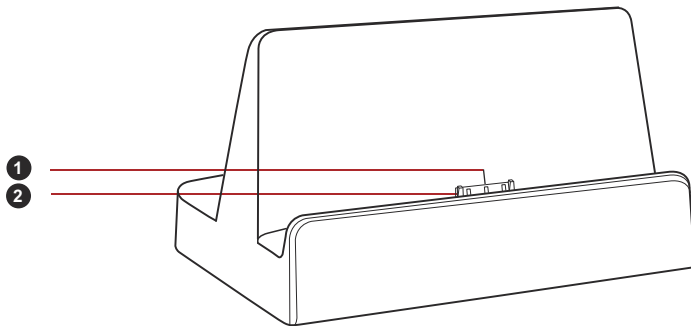

- 1. Docking mark
 - 2. Docking connector
- (Sample Illustration) Front of the dock*

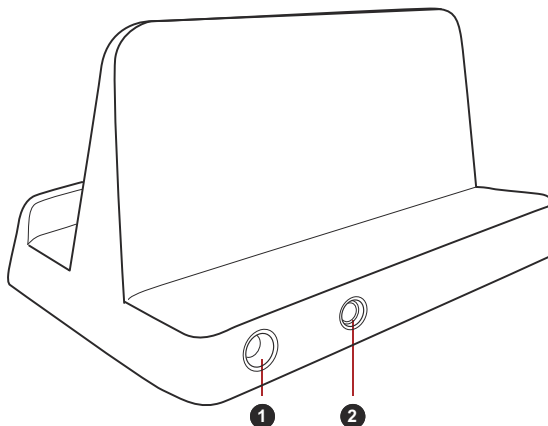

1. DC IN 19V jack

2. Headphone jack

(Sample Illustration) Back of the dock

Docking mark	This mark is used for aligning your tablet with the dock.
Docking connector	TOSHIBA Tablet connects the dock via docking connector.
Universal Serial Bus 2.0 ports	Universal Serial Bus ports, which comply to the USB 2.0 standard, are provided.
DC IN 19V jack	The AC adaptor connects to this jack in order to power the tablet and charge its internal batteries. Please note that you should only use the model of AC adaptor supplied with the tablet at the time of purchase - using the wrong AC adaptor can cause damage to the tablet.
HDMI port	HDMI port can connect with Type A connector HDMI cable. HDMI cable can send video and audio signals. In addition to this, it can send and receive control signals.

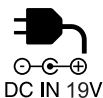

HDMI

HDMI port

HDMI port can connect with Type A connector HDMI cable.

HDMI cable can send video and audio signals. In addition to this, it can send and receive control signals.

Optional accessories

You are able to add a number of options and accessories in order to make your tablet even more powerful and convenient to use. For reference, the following list details some of the items that are available from your reseller or TOSHIBA dealer:

Universal AC Adaptor	If you frequently use your tablet at more than one site, it may be convenient to purchase an additional AC adaptor to be kept at each site in order to remove the need to always carry the adaptor with you.
Battery Pack	An additional battery pack can be purchased for use as either a spare or replacement.
TOSHIBA Tablet USB Cradle	The TOSHIBA Tablet USB Cradle provides the ports available on your tablet in addition to an HDMI port, two Universal Serial Bus ports (USB 2.0), a Headphone jack and a DC IN 19V jack.
TOSHIBA Tablet Cradle	The TOSHIBA Tablet Cradle provides the power charging for your TOSHIBA Tablet.

Troubleshooting

TOSHIBA have designed this tablet for durability, however, should problems occur you are able to use the procedures detailed in this chapter to help determine the cause.

All users should become familiar with this chapter as knowing what might go wrong can help prevent problems from occurring in the first place.

Problem solving process

Resolving problems will be much easier if you observe the following guidelines:

- Stop immediately when you recognize a problem exists as taking further action may result in data loss or damage, or you may destroy valuable problem related information that can help solve the problem.
- Observe what is happening - write down what the system is doing and what actions you performed immediately before the problem occurred.

Please also be aware that the questions and procedures described in this chapter are meant only as a guide, they are not definitive problem solving techniques. In reality many problems can be solved simply, but a few may require help from your reseller, dealer or service provider - if you find you need to consult others, be prepared to describe the problem in as much detail as possible.

Preliminary checklist

You should always consider the simplest solution first - the items detailed in this checklist are easy to fix and yet can cause what appears to be a serious problem:

- Make sure you turn on all peripheral devices before you turn on the tablet - this includes any other external device you are using.
- Before you attach an external device you should first turn the device off, then when you turn your device back on again it will recognize the new device.
- Make sure all optional accessories are configured properly in the tablet's setup program (please refer to the documentation included with the optional accessories for further information on its installation and configuration).
- Check all cables to ensure they are correctly and firmly attached to the tablet - loose cables can cause signal errors.

- Inspect all connecting cables for loose wires and all connectors for loose pins.

Always try to make detailed notes of your observations and keep them in a permanent error log - this will help you to describe your problems to your reseller, dealer or service provider. In addition, if a problem recurs, the log you have made will help to identify the problem faster.

Hardware and system checklist

This section discusses problems caused by your tablet's hardware or attached peripherals. Basic problems may occur in the following areas:

- Internal display panel
- Memory Card
- USB device
- Sound system
- External monitor
- Wireless LAN
- Bluetooth

Internal display panel

Apparent tablet's display panel problems may be related to the tablet's setup and configuration.

Problem	Procedure
Markings appear on the tablet's display panel	These marks may have come from contact with the touch screen. You should try to remove the marks by gently wiping the display panel with a clean dry cloth or, if this fails, with a good quality LCD screen cleaner. In this latter instance you should always follow the instructions with the screen cleaner and always ensure you let the display panel dry properly before closing it.
Problems above remain unresolved or other problems occur	You should initially refer to the documentation supplied with you software to determine if it is this that is causing the problems. If you are still unable to resolve the problem, contact your reseller, dealer or service provider.

Memory Card

Problem	Procedure
Memory Card error occurs	Remove the Memory Card from the tablet and then reinsert it in order to ensure it is firmly connected. If the problem persists, then you should refer to the documentation supplied with your Memory card for further information.

Problem	Procedure
You cannot write to a Memory Card	Remove the Memory Card from the tablet and check to ensure that it is not write protected.
You cannot read a file	Check to ensure the required file is actually on the Memory Card that is inserted into the tablet. If you are still unable to resolve the problem, contact your reseller, dealer or service provider.

USB device

In addition to the information in this section, please also refer to the documentation supplied with your USB device.

Problem	Procedure
USB device does not work	Remove the USB device from the tablet and then reconnect it in order to ensure it is firmly attached.

Sound system

In addition to the information in this section, please also refer to the documentation supplied with your audio device.

Problem	Procedure
No sound is heard	Adjust the volume.
	Check the software volume settings.
	Please check to see if Mute is turned to Off
	Check to make sure the headphone connection is secure.

External monitor

Please also refer to the documentation supplied with your monitor for further information.

Problem	Procedure
Monitor does not turn on	After confirming that the monitor's power switch is on, you should check the connections to make sure that the power cord/adaptor is firmly connected to the monitor and to a working power outlet.
No display	Try adjusting the contrast and brightness controls on the external monitor.

Problem	Procedure
Display error occurs	Check that the cable connecting the external monitor to the tablet is firmly attached. If you are still unable to resolve the problem, contact your reseller, dealer or service provider.

Wireless LAN

If the following procedures do not restore LAN access, consult your LAN administrator.

Problem	Procedure
Cannot access Wireless LAN	Make sure the tablet's Wireless communication functionality is set to on. If problems persist, contact your LAN administrator.

Bluetooth

Problem	Procedure
Cannot access Bluetooth device	Check to ensure the tablet's Bluetooth functionality is set to on in Apps → Settings → Bluetooth .

TOSHIBA Support

If you require any additional help using your tablet or if you are having problems operating the tablet, you may need to contact TOSHIBA for additional technical assistance.

Before you call

Some problems you experience may be related to software or the operating system so it is important that you investigate other sources of assistance first. Before contacting TOSHIBA, try the following:

- Review troubleshooting sections in the documentation supplied with your software and/or peripheral devices.
- If a problem occurs when you are running software applications, consult the software documentation for troubleshooting suggestions and consider calling the software company's technical support department for assistance.
- Consult the reseller or dealer from where you purchased your tablet and/or software - they are your best resource for current information and support.

TOSHIBA technical support

If you are still unable to solve the problem and suspect that it is hardware related, visit TOSHIBA technical support website
<http://www.toshiba.co.jp/worldwide/>.

Specifications

This appendix summarizes the tablet's technical specifications.

Physical Dimensions

Size	273 (w) x 177 (d) x 15.8 (h) millimeters (not including parts that extend beyond the main body).
-------------	--

Environmental Requirements

Conditions	Ambient temperature	Relative humidity
Operating	5°C (41°F) to 40°C (104°F)	0% to 85% (noncondensing)
Non-operating	-30°C (-22°F) to 60°C (140°F)	0% to 90% (noncondensing)
Wet-bulb temperature	29°C maximum	
Conditions	Altitude (from sea level)	
Operating	0 to 10,000 feet (3,048 meters)	
Non-operating	0 to 40,000 feet (12,192 meters)	

Power Requirements

AC adaptor	100-240 volts AC 50 or 60 hertz (cycles per second)
Tablet	19V DC

Regulatory information

Copyright

© 2011 by TOSHIBA Corporation. All rights reserved. Under the copyright laws, this manual cannot be reproduced in any form without the prior written permission of TOSHIBA. No patent liability is assumed, with respect to the use of the information contained herein.

TOSHIBA AT100 User's Manual

First edition May 2011

Disclaimer

This manual has been validated and reviewed for accuracy. The instructions and descriptions it contains are accurate for this tablet at the time of this manual's production. However, succeeding devices and manuals are subject to change without notice. TOSHIBA assumes no liability for damages incurred directly or indirectly from errors, omissions or discrepancies between this tablet and the manual.

This product incorporates copy protection technology that is protected by U.S. and foreign patents, including patent numbers 5,315,448; 5,583,936; 6,836,549; and 7,050,698 and other intellectual property rights. The use of Rovi Corporation's copy protection technology in the product must be authorized by Rovi Corporation. Reverse engineering or disassembly is prohibited.

TO THE MAXIMUM EXTENT PERMITTED BY APPLICABLE LAW, TOSHIBA CORPORATION, ITS AFFILIATES AND/OR SUPPLIERS ("TOSHIBA") DISCLAIM ALL WARRANTIES WITH REGARD TO THE SOFTWARE, EITHER EXPRESSLY -IMPLIED, OR STATUTORY, INCLUDING, BUT NOT LIMITED TO, THE WARRANTY OF NONINFRINGEMENT OF THIRD PARTY RIGHTS, AND THE IMPLIED WARRANTIES AND CONDITIONS OF MERCHANTABILITY AND FITNESS FOR A PARTICULAR PURPOSE. THE ENTIRE RISK AS TO THE QUALITY AND PERFORMANCE OF THE SOFTWARE IS WITH YOU. TOSHIBA SHALL NOT WARRANT THAT THE FUNCTIONS CONTAINED IN THE SOFTWARE WILL MEET YOUR REQUIREMENTS OR THAT THE OPERATION OF THE SOFTWARE WILL BE UNINTERRUPTED OR ERROR-FREE.

Notwithstanding the above, portions of the software include software files subject to certain open source license agreements, and such open source software files are subject to the notices and additional terms and conditions that are referenced in the End User License Agreement (“EULA”) shown in “Toshiba Legal Information” section of the “Legal information” available under the “About tablet” tab on the “Settings” menu. Such open source software files are provided on an “AS IS” basis to the maximum extent permitted by applicable law.

Please carefully read “Open source license” section of the “Legal Information” available under the “About tablet” tab on the “Settings” menu for the relevant copyright and licensing terms. If there is any discrepancy between the terms and conditions of the applicable open source license agreement and the EULA, the terms and conditions of the applicable open source license agreement prevail with respect to the applicable open source software.

Until the date that is three years after you acquired the Software, you may obtain a copy of the source code corresponding to the binaries for GPL-licensed file by sending a request to TOSHIBA customer service at [http://support.toshiba-tie.co.jp/android/index_e.htm], and TOSHIBA will send you a link to such source code.

Trademarks

Google, the stylized Google logo, Android, the stylized Android logo, Android Market, the stylized Android Market logo, Google Apps, Google Calendar, Google Latitude, Google Maps, Google Talk, Picasa, and YouTube are trademarks of Google Inc. All other company and product names may be trademarks of the companies with which they are associated.

Availability of Google applications, services, and features may vary by country, carrier, phone model, and manufacturer.

Bluetooth is a trademark owned by its proprietor and used by TOSHIBA under license.

Wi-Fi is a registered trademark of the Wi-Fi Alliance.

Secure Digital and SD are trademarks of SD Card Association.

MultiMediaCard and MMC are trademarks of MultiMediaCard Association.

HDMI, the HDMI logo and High-Definition Multimedia Interface are trademarks or registered trademarks of HDMI Licensing LLC.

Adobe, Adobe PDF, Flash, AIR, the Flash logo and the AIR logo are either registered trademarks or trademarks of Adobe Systems Incorporated in the United States and/or other countries.



is a trademark of SRS Labs, Inc.

SRS Premium Voice PRO technology is incorporated under license from SRS Labs, Inc.

TouchSense is a trademark of Immersion Corporation.

Other trademarks and registered trademarks not listed above may be used in this manual.

AVC/H.264 License Notice

THIS PRODUCT IS LICENSED UNDER THE AVC PATENT PORTFOLIO LICENSE FOR THE PERSONAL AND NON-COMMERCIAL USE OF A CONSUMER TO (i)ENCODE VIDEO IN COMPLIANCE WITH THE AVC STANDARD ("AVC VIDEO") AND/OR (ii)DECODE AVC VIDEO THAT WAS ENCODED BY A CONSUMER ENGAGED IN A PERSONAL AND NON-COMMERCIAL ACTIVITY AND/OR WAS OBTAINED FROM A VIDEO PROVIDER LICENSED TO PROVIDE AVC VIDEO. NO LICENSE IS GRANTED OR SHALL BE IMPLIED FOR ANY OTHER USE. ADDITIONAL INFORMATION MAY BE OBTAINED FROM MPEG LA,L.L.C. SEE [HTTP://WWW.MPEGLA.COM](http://WWW.MPEGLA.COM)

FCC information

FCC notice "Declaration of Conformity Information"

This equipment has been tested and found to comply with the limits for a Class B digital device, pursuant to part 15 of the FCC rules. These limits are designed to provide reasonable protection against harmful interference in a residential installation. This equipment generates, uses and can radiate radio frequency energy and, if not installed and used in accordance with the instructions, may cause harmful interference to radio communications. However, there is no guarantee that interference will not occur in a particular installation. If this equipment does cause harmful interference to radio or television reception, which can be determined by turning the equipment off and on, the user is encouraged to try to correct the interference by one or more of the following measures:

- Reorient or relocate the receiving antenna.
- Increase the separation between the equipment and receiver.
- Connect the equipment into an outlet on a circuit different from that to which the receiver is connected.
- Consult the dealer or an experienced radio/TV technician for help.



Only peripherals complying with the FCC class B limits may be attached to this equipment. Operation with non-compliant peripherals or peripherals not recommended by TOSHIBA is likely to result in interference to radio and TV reception. Shielded cables must be used between the external devices and the TOSHIBA AT100 Tablet's Universal Serial Bus (USB 2.0) ports, HDMI port and microphone/headphone combo jack. Changes or modifications made to this equipment, not expressly approved by TOSHIBA or parties authorized by TOSHIBA could void the user's authority to operate the equipment.

FCC conditions

This tablet complies with part 15 of the FCC Rules. Operation is subject to the following two conditions:

1. This tablet may not cause harmful interference.
2. This tablet must accept any interference received, including interference that may cause undesired operation.

Contact

Address: TOSHIBA America Information Systems, Inc.
9740 Irvine Boulevard
Irvine, California 92618-1697

Telephone: (949) 583-3000

Caution: Exposure to Radio Frequency Radiation.

The radiated output power of the Wireless LAN is far below the FCC radio frequency exposure limits. Nevertheless, the Wireless LAN shall be used in such a manner that the potential for human contact during normal operation is minimized.

In the usual operating configuration, the distance between the antenna and the user should not be less than 20cm. Please refer to the "Grand Tour" section in this manual for the details regarding antenna location.

The installer of this radio equipment must ensure that the antenna is located or pointed such that it does not emit RF field in excess of Health Canada limits for the general population; consult Safety Code 6, obtainable from Health Canada's website.

CE compliance



This product is CE marked in compliance with the essential requirements and other relevant provisions of Directive 1999/5/EC. Responsible for CE marking is Toshiba Europe GmbH, Hammfelddamm 8, 41460 Neuss, Germany. A copy of the official Declaration of Conformity can be obtained from following website: <http://epps.toshiba-teg.com>.

Indication of restrictions of use

France:	Outdoor use limited to 10mW e.i.r.p. within the band 2454-2483.5MHz	Military Radiolocation use. Refarming of the 2.4GHz band has been ongoing in recent years to allow current relaxed regulation Full implementation planned 2012
Italy:	-	For private use, a general authorization is required if WAS/RLAN's are used outside own premises. For public use, a general authorization is required
Luxembourg:	Implemented	General authorization required for network and service supply
Norway:	Implemented	This subsection does not apply for the geographical area within a radius of 20 km from the centre of Ny-Alesund

Working environment

The Electromagnetic Compliance (EMC) of this product has been verified typically for this product category for a so called Residential, Commercial & Light Industry Environment. Any other working environment has not been verified by Toshiba and the use of this product in these working environments is maybe restricted or cannot be recommended. Possible consequences of the use of this product in non verified working environments can be: Disturbances of other products or of this product in the nearby surrounding area with temporarily malfunction or data loss/corruption as result. Example of non verified working environments and related advices:

Industrial environment (e.g. where 3-phase 380V mains is being used mainly): Danger of disturbances of this product due to possible strong electromagnetic fields especially near to big machinery or power units.

Medical environment: The compliance to the Medical Product Directive has not been verified by Toshiba, therefore this product cannot be used as a medical product without further verification. The use in usual office environments e.g. in hospitals should be no problem if there is no restriction by the responsible administration.

Automotive environment: Please search the owner instructions of the related vehicle for advices regarding the use of this product (category).

Aviation environment: Please follow the instructions of the flight personnel regarding restrictions of use.

Additional environments not related to EMC

Outdoor use: As a typical home/office equipment this product has no special resistance against ingress of moisture and is not strong shock proofed.

Explosive atmosphere: The use of this product in such special working environment (Ex) is not allowed.

REACH - Compliance Statement

The new European Union (EU) chemical regulation, REACH (Registration, Evaluation, Authorization and Restriction of Chemicals), entered into force on 1 June 2007. Toshiba will meet all REACH requirements and is committed to provide our customers with information about the chemical substances in our products according to REACH regulation.

Please consult the following website www.toshiba-europe.com/computers/info/reach for information about the presence in our articles of substances included on the candidate list according to article 59(1) of Regulation (EC) No 1907/2006 („REACH“) in a concentration above 0.1 % weight by weight.

Following information is only valid for EU-member States:

Disposal of products



The crossed out wheeled dust bin symbol indicates that products must be collected and disposed of separately from household waste. Integrated batteries and accumulators can be disposed of with the product. They will be separated at the recycling centres.

The black bar indicates that the product was placed on the market after August 13, 2005.

By participating in separate collection of products and batteries, you will help to assure the proper disposal of products and batteries and thus help to prevent potential negative consequences for the environment and human health.

For more detailed information about the collection and recycling programmes available in your country, please visit our website (<http://eu.computers.toshiba-europe.com>) or contact your local city office or the shop where you purchased the product.

Disposal of batteries and/or accumulators



Pb, Hg, Cd

The crossed out wheeled dust bin symbol indicates that batteries and/or accumulators must be collected and disposed of separately from household waste.

If the battery or accumulator contains more than the specified values of lead (Pb), mercury (Hg), and/or cadmium (Cd) defined in the Battery Directive (2006/66/EC), then the chemical symbols for lead (Pb), mercury (Hg) and/or cadmium (Cd) will appear below the crossed out wheeled dust bin symbol.

By participating in separate collection of batteries, you will help to assure the proper disposal of products and batteries and thus help to prevent potential negative consequences for the environment and human health. For more detailed information about the collection and recycling programmes available in your country, please visit our website (<http://eu.computers.toshiba-europe.com>) or contact your local city office or the shop where you purchased the product.



These symbols may not stick depending on the country and region where you purchased.

Canadian regulatory information (Canada only)

This digital apparatus does not exceed the Class B limits for radio noise emissions from digital apparatus as set out in the Radio Interference Regulation of the Canadian Department of Communications.

Note that Canadian Department of Communications (DOC) regulations provide, that changes or modifications not expressly approved by TOSHIBA Corporation could void your authority to operate this equipment.

This Class B digital apparatus meets all requirements of the Canadian Interference-Causing Equipment Regulations.

Cet appareil numérique de la class B respecte toutes les exgences du Règlement sur le matériel brouilleur du Canada.

Canada – Industry Canada (IC)

This tablet complies with RSS 210 of Industry Canada.

Operation is subject to the following two conditions: (1) this tablet may not cause interference, and (2) this tablet must accept any interference, including interference that may cause undesired operation of this tablet.

The term "IC" before the equipment certification number only signifies that the Industry Canada technical specifications were met.

Wireless LAN and your Health

Wireless LAN products, like other radio devices, emit radio frequency electromagnetic energy. The level of energy emitted by Wireless LAN devices however is far much less than the electromagnetic energy emitted by wireless devices like for example mobile phones.

Because Wireless LAN products operate within the guidelines found in radio frequency safety standards and recommendations, TOSHIBA believes Wireless LAN is safe for use by consumers. These standards and recommendations reflect the consensus of the scientific community and result from deliberations of panels and committees of scientists who continually review and interpret the extensive research literature.

In some situations or environments, the use of Wireless LAN may be restricted by the proprietor of the building or responsible representatives of the organization. These situations may for example include:

- Using the Wireless LAN equipment on board of airplanes, or
- In any other environment where the risk of interference to other devices or services is perceived or identified as harmful.

If you are uncertain of the policy that applies on the use of wireless devices in a specific organization or environment (e.g. airports), you are encouraged to ask for authorization to use the Wireless LAN device prior to turning on the equipment.